

## BOS1901 Development Kit

### 1 Features

- Plug and play development kit to experience piezoelectric actuator button and haptic feedback.
- Low-power BOS1901 integrated circuit, high voltage driver with SPI digital interface.
- Power supply via the USB port.
- Graphical user interface for ease of use.
- Standard USB audio to prototype haptic effects in MATLAB®, Python®, Audacity® and many other softwares<sup>1</sup>.
- Easy generation of high-voltage waveforms up to 190 Vpp.
- Two breakable miniature PCBs with BOS1901 drivers for prototyping.
- Standard commercial piezo actuator included in the Kit:<sup>2</sup>
  - Starter Set: TDK PowerHap™ 1204 lateral

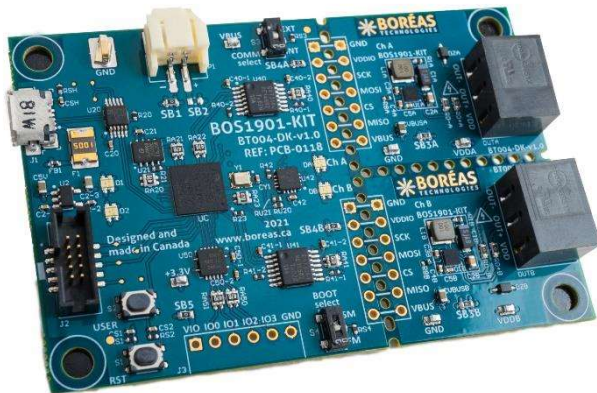

Figure 1: BOS1901-KIT overview

### 2 Description

The BOS1901-KIT is a development kit to get familiar with the BOS1901 Piezo Haptic Driver IC.

The USB-powered kit appears as an USB Audio device for the computer, which allows quick and easy generation of waveforms using existing audio software like Audacity® for haptic prototyping.

The firmware supports autonomous operation for easy integration into development prototypes.

Each breakable miniature PCB gives access to all signals allowing the users to experiment with the BOS1901 using a development platform of their choice.

Standard commercial piezo actuators are provided as a starting point to begin experiencing with haptic feedback.

Table 1: Ordering information

PRODUCT	DESCRIPTION
<b>BOS1901-KIT-B02</b>	Starter Set with One Actuator (replacement of BOS1901-KIT-B)

For details see section 2







<sup>1</sup> MATLAB® is registered trademark of The MathWorks, Inc. Python® is a registered trademark of the PSF Audacity® is a registered trademark of Dominic Mazzoni

<sup>2</sup> PowerHap™ is a trademark of TDK Corporation Python™ is a trademark of Bimitech Inc.

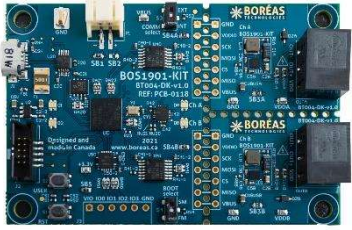
## 3 What's in the Box

The BOS1901-KIT is currently available in one package: *Starter Set*. The following table shows the content of the set.

Table 2: *Starter Set BOS1901-KIT-B02* development kit content

#	ITEM	DESCRIPTION	REFERENCE
1	Evaluation PCB	BOS1901-KIT Board	
2	USB Cable	Cable to connect the evaluation PCB to a computer Stewart Connector part number SC-2AMK001F	
3	TDK Piezo Actuator	<a href="#">TDK Mini PowerHap™ 1204H018V060 Actuator</a> Ordering : Z63000Z2910Z 1Z 39 Capacitance : 0.42 $\mu$ F Dim : 12.0 x 4.0 x 1.8 mm	
4	Two (2) 3-position terminal block connector	Male connector used for interfacing the piezoelectric actuator on the board. Metz Connect part number 31369103	
5	Two (2) 7-position thru-hole header connector	2.54 mm pitch header connector for probing interface signals and supply. Sullins Connector Solutions part number PRPC007SAAN-RC or equivalent.	
6	6-position thru-hole header connector	2.54 mm pitch header connector for connection to external system. Würth Elektronik part number 61300611021 (6-pin) or equivalent.	

## 4 Board Overview

The purpose of this section is to show the location of the components that allow you to interact with the BOS1901-KIT board. This section is in a way the definition of the user interface provided by the development board. The focus is on buttons and LEDs which allow you to know and modify the current operating state.

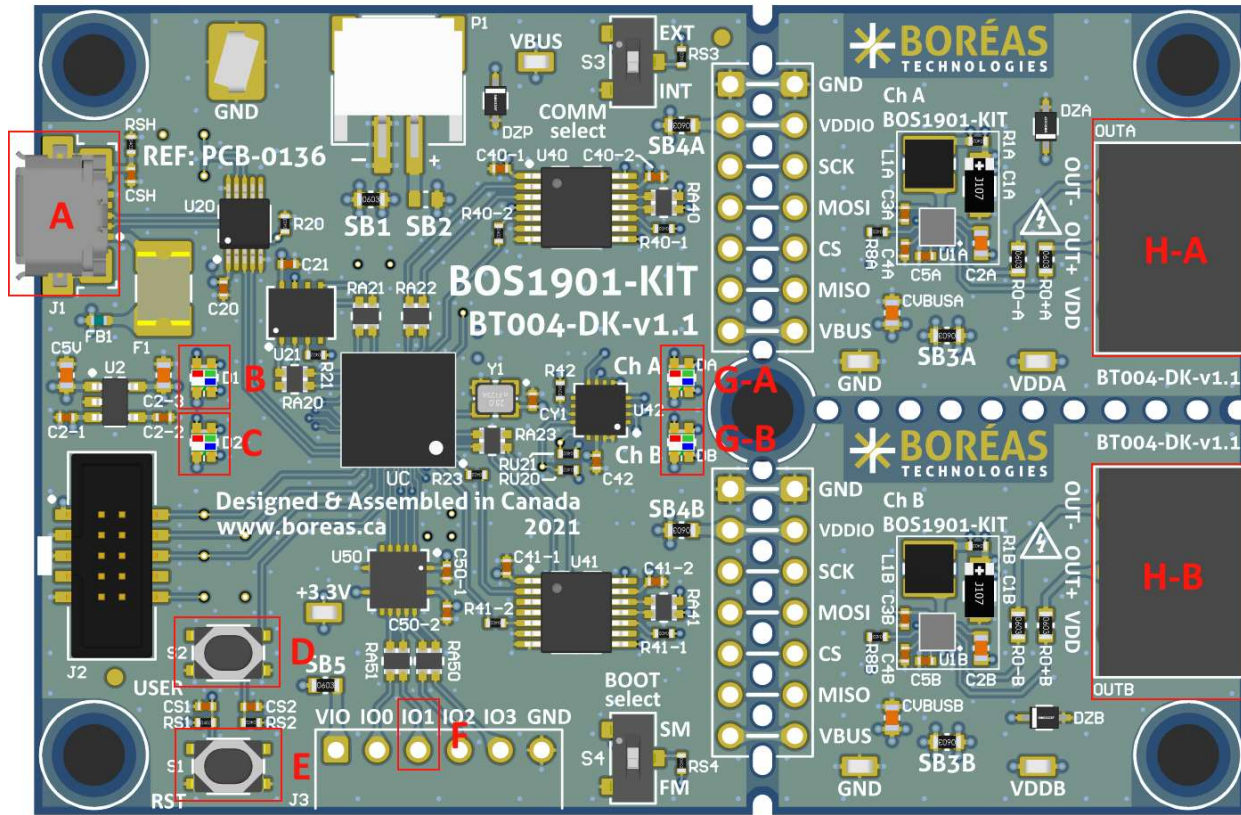

Figure 2: BOS1901-KIT board user interface

Table 3: BOS1901-KIT board user interface

Components	Name	Description
A	USB connector	Supply power and provides connectivity with the GUI.
B	Operation mode LED	Flashing if alive and color shows the current operation mode.
C	BOS1901 error LED	Flashing if an error is detected on a BOS1901.
D	Change operation mode button	Change the current operation mode on press.
E	Reset button	Reset the micro-controller on press.
F	GPIO to trigger haptic feedback	If configured as a haptic trigger event, a falling edge on that GPIO will trigger a haptic feedback on a piezo actuator.
G	BOS1901 A/B status LED	LEDs displaying the current state of the BOS1901.
H	BOS1901 A/B terminal block	Terminals where piezoelectric actuator are connected.

## 4.1 Operation Mode LED Details

This section describes the meaning of the different colors and state transitions of the operation mode LED.

Table 4: Operation mode LED detail

Pattern	Color	Description
1 second on, 1 second off	Green	In <i>Haptic mode</i> and working normally.
1 second on, 1 second off	Blue	In <i>Audio mode</i> and working normally.

Any other pattern or color behavior maybe caused by unofficial firmware or bug.

## 4.2 BOS1901 Error LED Details

This section describes the meaning of the different colors and state transitions of the BOS1901 Error LED. The two BOS1901 of the BOS1901-KIT board are monitored to validate the presence of an internal error. If an error is detected, the BOS1901 Error LED is used to indicate the detection of this error. See section 8.5.3, for more information on the procedure to get the details of the error.

Table 5: BOS1901 error LED details

Pattern	Color	Description
Always off	N/A	No error detected on any BOS1901.
700 ms on, 700 ms off	Red	At least one internal error has been detected by a BOS1901.

## 4.3 BOS1901 Status LEDs Details

This section describes the meaning of the different colors and state transitions of the BOS1901 status LED. There is a status LED for each BOS1901.

Table 6: BOS1901 status LED details

Pattern	Color	Description
Always on	Green	Sensing the voltage of the piezo electric actuator to detect press or release event.
Always on	Blue	Sending haptic feedback data to the BOS1901.

## 5 Your First Piezoelectric Actuator Button Experience

The BOS1901 and a piezoelectric actuator can be used together to implement the equivalent of a button. Before being shipped, the BOS1901-KIT board is set up in this button mode, so that you can experience it without additional extensive configuration or software installation.

1. Open the box, take the BOS1901-KIT board, the USB cable, the terminals block plugs, and the TDK 1204 piezo actuators.
2. Insert the terminal block plugs into the development kit's terminal blocks.
3. Using a small slotted screwdriver, install TDK 1204 piezo electric actuator on terminals block plugs. **Pay attention to connect the red wire on the OUT+ terminal and the black wire on the OUT- terminal.** Refer to Figure 2 to identify location of OUT+ and OUT- on the terminal block.
4. Connect the development kit board to a USB port using the USB cable.
5. When the operation mode green LED is blinking and BOS1901 A/B status LED are solid green, you are ready to go. Press on the piezo actuation to experience the piezo actuator button.

## 6 Get Started

The purpose of this section is to give instructions on where to get the latest versions of Boréas software and firmware. Keeping the software up to date ensures the latest features available are taken advantage of.

### 6.1 Creating a Boréas Account

Relevant documentation and software are available in the support section of Boréas website. Here are the instructions for accessing it:

- 1) Go to <https://www.boreas.ca/account>.
- 2) Click on “Create account”.
- 3) Enter the requested information.
- 4) Click on “Create Account”.

### 6.2 Identifying the BOS1901-KIT Board and BOM Revision

Each PCB board reference design (“REF:”) and revision (BT###-DK-v#. #) numbers are printed on the board silkscreen. A printed label stuck on the back of the PCB provides the board part number (P/N), containing the BOM revision suffix “-Bx”), and the assembly code (“#####AA”). The table below indicates compatibility with the firmware and Devkit Controller software.

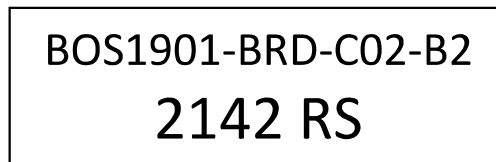

Figure 3: Label example giving board part number with BOM revision suffix, and assembly code

Table 7: BOS1901-KIT board and software compatibility list

BOARD P/N**	PCB REFERENCE	COMPATIBLE FIRMWARE	COMPATIBLE PC SOFTWARE
BOS1901-BRD-C02-B1*	PCB-0118 BT004-DK-v1.0	BOARD_PCB_136_B1_DEVKIT-{VERSION}.hex Version starting at 1.10.x	Starting at 2.9.x
BOS1901-BRD-C02-B1*	PCB-0136 BT004-DK-v1.1	BOARD_PCB_136_B1_DEVKIT-{VERSION}.hex Version starting at 1.10.x	Starting at 2.9.x
BOS1901-BRD-C02-B2	PCB-0136 BT004-DK-v1.1	BOARD_PCB_136_B2_DEVKIT-{VERSION}.hex Version starting at 1.10.x	Starting at 2.9.x

\* Boards without a label are equivalent to BOS1901-BRD-C02-B1.

\*\* Board P/N include BOM revision suffix

Any PCB reference design number not listed into Table 7 are considered obsolete. The relevant documentation and software for obsolete products are still available into the archive section of our web site.

## 6.3 Download Boréas Application

- 1) Log in your Boréas account.
- 2) Go to the "Technical Documents" section.
- 3) Click on the "BOS1901-KIT Documents" link.
- 4) Scroll down to section BOS1901-KIT Controller (GUI).
- 5) Download the appropriate GUI version based on your development kit identification.

## 6.4 Install Boréas Application

Double click on the installer executable you downloaded and follow the instructions.

## 6.5 Upgrade Development Kit Firmware

The native BOS1901-KIT board firmware includes an over-USB firmware upgrade mechanism. The BOS1901-KIT software will upgrade the firmware if needed on next connection with the development kit.

- 1) Connect the development kit to a PC using the USB cable.
- 2) Start the BOS1901-KIT software.
- 3) Select the development kit communication port into the drop-down field:

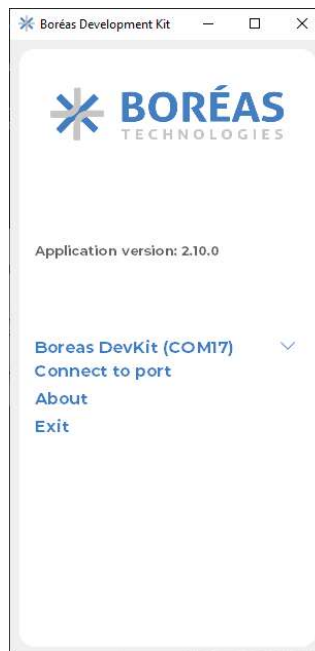

Figure 4: Connection dialog

- 4) Click on *Connect to port*.
- 5) If an upgrade is needed the BOS1901-KIT software will pop up a dialog:

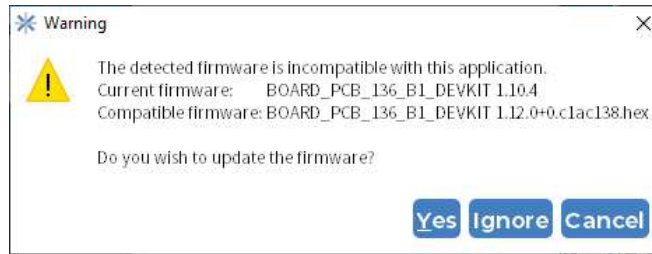

Figure 5: BOS1901-KIT Firmware upgrade dialog

- 6) Click on *Yes* to proceed and wait for the update process to complete, or click on *Ignore* to keep the currently installed firmware and still try to connect.
- 7) BOS1901-KIT software will automatically start after the upgrade.
- 8) All is up-to-date and ready to go.



## 7 Product Overview

The BOS1901-KIT has been designed to meet a multitude of needs. The main objective is to demonstrate the capacity of the BOS1901 but also to help integrators in the development of haptic effects and in its product prototyping.

**The BOS1901-KIT is delivered with a graphical user interface (GUI) for ease of use but it is not required to operate.** It can save and restore its configuration at start-up. We will refer to operation without the GUI by saying that the development board is used autonomously. It is configured in one of these autonomous mode before shipping (see section 5). We will explain in more detail the so-called autonomous modes in this document.

**The BOS1901-KIT supports multiple operation modes:**

*Table 8: Operation mode list*

Mode	Will help you to
<i>Haptic</i>	<ul style="list-style-type: none"> <li>• Experience piezo haptic button emulation.</li> <li>• Experiment with simple waveforms on various piezoelectric actuators.</li> <li>• Experiment with piezoelectric device sensing.</li> <li>• Evaluate any piezoelectric actuator for your application.</li> <li>• Evaluate BOS1901 performance (waveform output, power consumption) in the context of your application.</li> <li>• Optimize BOS1901 operation using specific registers value.</li> <li>• Command BOS1901-KIT waveform trigger from your system using an external trigger signal.</li> </ul>
<i>Audio</i>	<ul style="list-style-type: none"> <li>• Easily experiment with various waveform shapes and amplitudes.</li> <li>• Easily produce and compare various waveforms and identify the effects most suited for your application.</li> <li>• Play synchronous waveforms on both channels of BOS1901-KIT.</li> </ul>

**In *Haptic mode*, the GUI allows you to fire a given waveform from a variety of trigger mechanisms.**

The BOS1901-KIT is used to test the capacity of the BOS1901 with various piezoelectric actuators. The trigger events that can be used are: an action *Play* in the GUI, a rising edge on IO1, an action of pressing and releasing the piezoelectric actuator. When the IO1 or the piezoelectric actuator are used as trigger, the development kit can work without the GUI. The GUI also provides a section to read and write all registers of the IC. For more details about this mode refer to section 8.5.1

**In *Audio mode*, the development kit is detected as a standard stereo USB audio device by the PC.**

We know that our customers require more flexibility and control over the waveform used for their haptic effects. For these reasons, we put at your disposal the audio mode which allows you to have complete control over the wave transmitted to the BOS1901 via the USB port. Your PC can select the BOS1901-KIT as an audio card stereo output. You can configure audio mode settings using the graphical user interface, but this mode is designed to work without the GUI. For more details about the audio mode refers to section 8.5.2.

**The BOS1901-KIT development kit can be used as a basis for the development of a prototype.**

It is possible to connect an external SPI master without separating the breakable mini-boards from the BOS1901-KIT. This operation requires a good knowledge of the electrical design of the BOS1901-KIT. For more details about the hardware refers to section 9.

## 8 Boréas Development Kit Software v2.10.x

### 8.1 Overview

**Boréas Development Kit** software is a desktop application intended to ease evaluation of the BOS1901.

In Haptic mode, the tool can be used to:

- Play a sinusoidal waveform on-demand.
- Configure the BOS1901-KIT board to play a sinusoidal waveform when:
  - a signal is received on the pin IO1.
  - press and release events are detected on a piezo actuator (button emulation).
- Have a read/write access to the registers of the BOS1901.
- Monitor the BOS1901 status and display any error.
- Reset the BOS1901-KIT board to its factory default state.
- Change the operation mode of the BOS1901-KIT board.

In Audio mode, the tool can be used to:

- Configure the minimum and maximum voltage of each output channel.
- Reset the BOS1901-KIT board to its factory default state.
- Change the dev kit operation mode.

### 8.2 PC Requirements

- OS: Windows 10
- Minimum display resolution: 1366 X 768
- Storage: At least 200 MB of available space.

### 8.3 Software Installation

Refer to the section Get Started.

## 8.4 Disconnected State

At start-up, the application is in disconnect state. The communication port is not connected with the BOS1901-KIT board. A drop-down list allows the user to select the BOS1901-KIT board to use. (1 entry per board connected to the PC).

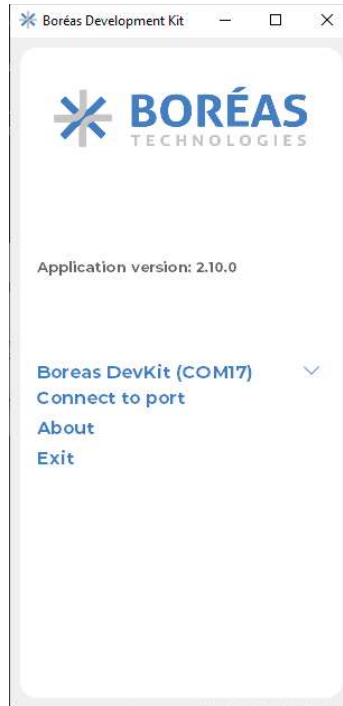

Figure 6 Application window in disconnected state

To transition to the connected state:

1. Select the communication port associated to the BOS1901-KIT board.
2. Press the *Connect to port* button to establish the communication.

Upon connection, the compatibility between the application and the board firmware will be validated and a message dialog will appear if the firmware of the kit needs to be updated. (More details are provided in the section [Upgrade your development kit firmware](#)).

The application will automatically return to the disconnected state if:

- The connection with the BOS1901-KIT board is lost.
- The BOS1901-KIT board power cycles.
- The BOS1901-KIT board is returned to factory default.
- The user presses the mode change button on the BOS1901-KIT application.
- The user presses the mode change button on the BOS1901-KIT board.

## 8.5 Connected State

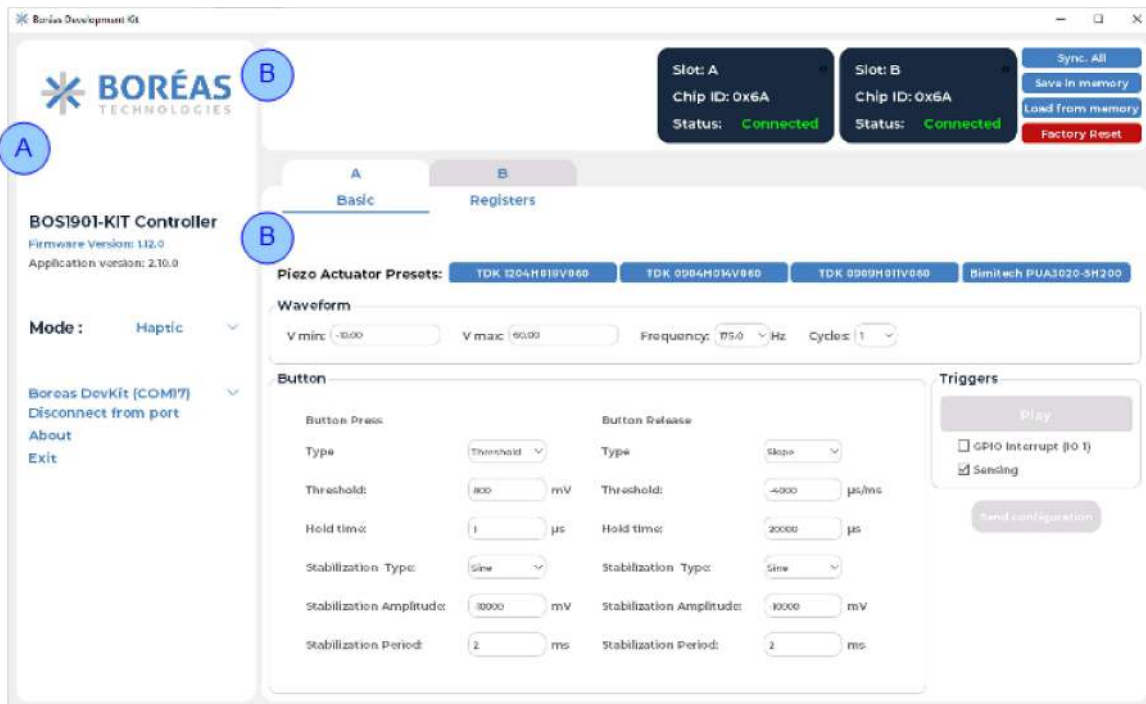

Figure 7 Application window when connected (Haptic mode)

### Left Section (A): Menu

The left menu is used to present information about the BOS1901-KIT board:

- Firmware and software version
- Operation mode (*Haptic* or *Audio*)
- Communication port of the currently connected BOS1901-KIT board
- Status (if errors are detected, they will be displayed in the bottom section of the left panel).

In this menu, buttons are also available to:

- Change the mode of the BOS1901-KIT board.
- Close the communication link with the BOS1901-KIT board (to return to the disconnected state)
- Show version information of the software.
- Exit from the application.

### Right Section (B): Content

The BOS1901-KIT board supports 2 modes of operation: *Haptic* mode and *Audio* mode.

The right section of the application main window presents the capabilities and the features offered in each operation modes. Details for each mode are presented in the next sections.

## 8.5.1 Haptic Mode

### 8.5.1.1 Panel Overview

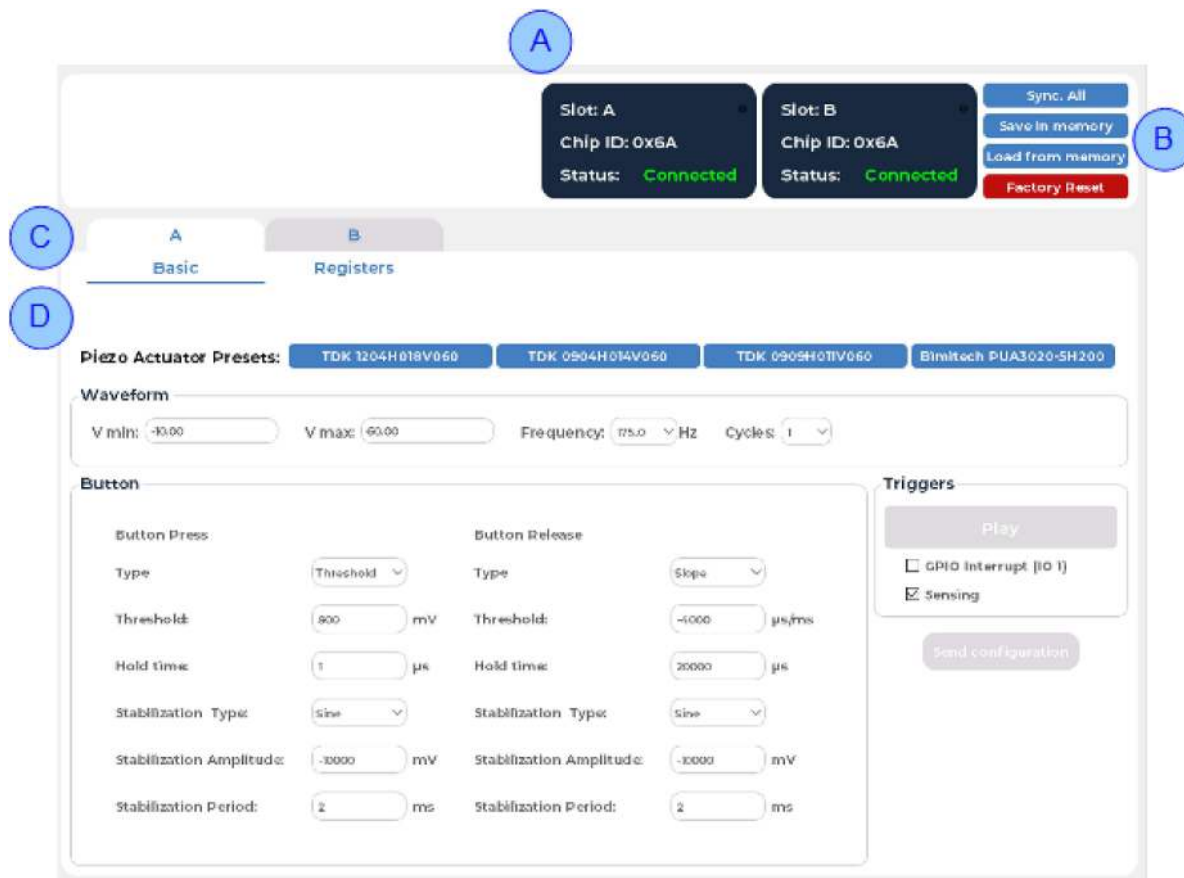

Figure 8: Panel overview – Haptic mode

#### Section A: Drivers Identification

The top of the right panel provides information about the driver connected to the microcontroller. The associated chip ID will appear, and the driver is marked as “Connected”.

#### Section B: Buttons

**Sync. All / Desync. All:** Enables / disables the synchronized feedback mode. (More details provided in the use cases section)

**Save in memory:** Saves the current configuration (waveform, sensing parameters and triggers) to the board memory. Those parameters are automatically loaded at the next power up. This allows specific configurations to run in autonomous mode. This mode can also be operated with the BOS1901-KIT board powered from a battery bank or USB charger.

**Load from memory:** Changing parameters with the interface allows experimenting various behaviors. Changing those parameters and sending them to the board does not affect the board memory state which is loaded automatically at power up. Clicking the *Load from memory* button will return the board to the configuration contained in its memory and load this configuration in the interface window.

**Factory Reset:** Resets the BOS1901-KIT board to its default factory state. This action will also trigger a reset of the BOS1901-KIT board and the application will return to its disconnected state.

### Section C: Channel Selection Tabs

Select the channel to configure (channel *A* or channel *B*)

### Section D: Basic and Registers Tabs

The basic panel provides functionalities to configure the BOS1901-KIT board (configure waveform, sensing parameters and triggers).

The register panel provides a read and write access to the registers of the BOS1901. More details about each view will be provided in the use cases sections that follow.

## 8.5.1.2 Play a Waveform - Manual Trigger

### Description

User configures a sinusoidal waveform and plays it on a piezo actuator (channel A or B) by pressing the *Play* button in the application.

### Prerequisites

- Software is connected to the BOS1901-KIT board in *Haptic* mode.

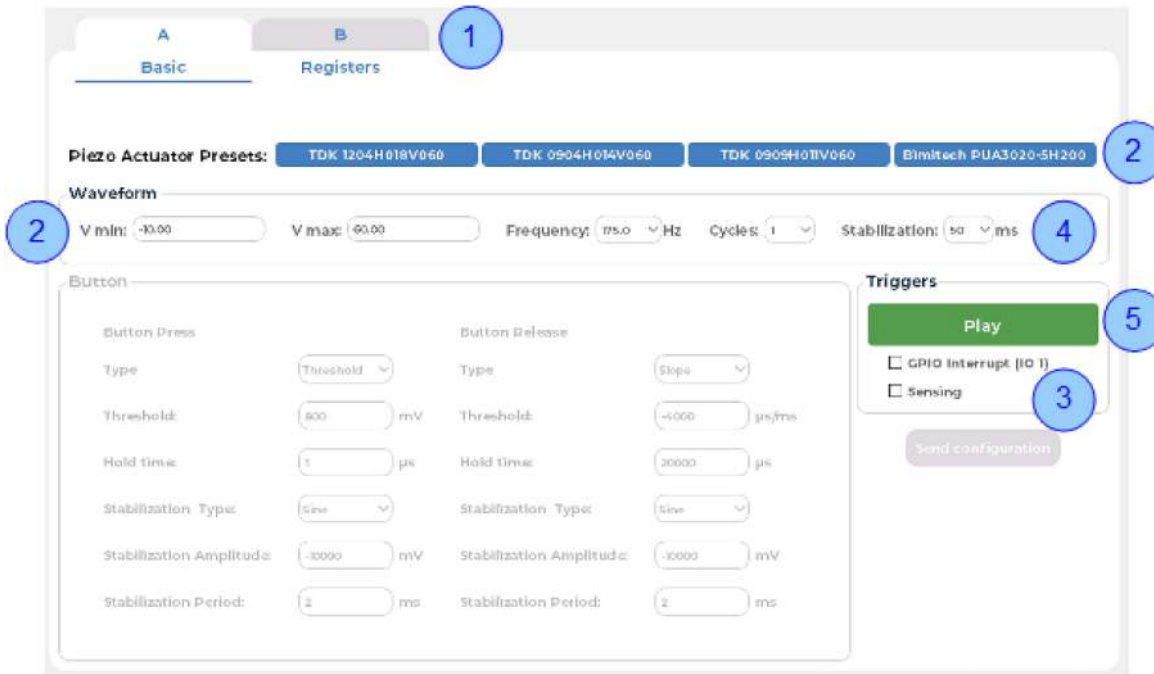

Figure 9: Play waveform – Manual trigger

### Steps

1. Select a channel tab (A or B)
2. If the board is connected to a piezo actuator supplied in the BOS1901-KIT, click on the corresponding piezo electric preset button to set the voltage operating range ( $V_{min}$  and  $V_{max}$ ). Otherwise, manually set the  $V_{min}$  and  $V_{max}$  fields in the *Waveform* section.
3. In the *Triggers* section, uncheck *Sensing* checkbox.
4. Configure the waveform:
  - Sinusoidal waveform frequency (between 100.0 and 300.0 Hz)
  - Number of cycles (between 1 and 254)
  - Set the stabilization time (between 0 and 1000 ms)
5. In the *Triggers* section, click on *Play* button to play the wave on the piezoelectric actuator.
6. (Optional): Change the waveform parameters ( $V_{min}$ ,  $V_{max}$ , *Frequency*, *Cycles* and *Stabilization*) to see how it change the feedback when the play button is pressed.



## 8.5.1.3 Play a Waveform - External Trigger (GPIO)

### Description

User configures the BOS1901-KIT board to play a sinusoidal waveform on the detection of a rising edge on the IO1. The input signal is debounced with 5 ms delay.

### Prerequisites

- Software is connected to the BOS1901-KIT board in *Haptic* mode.

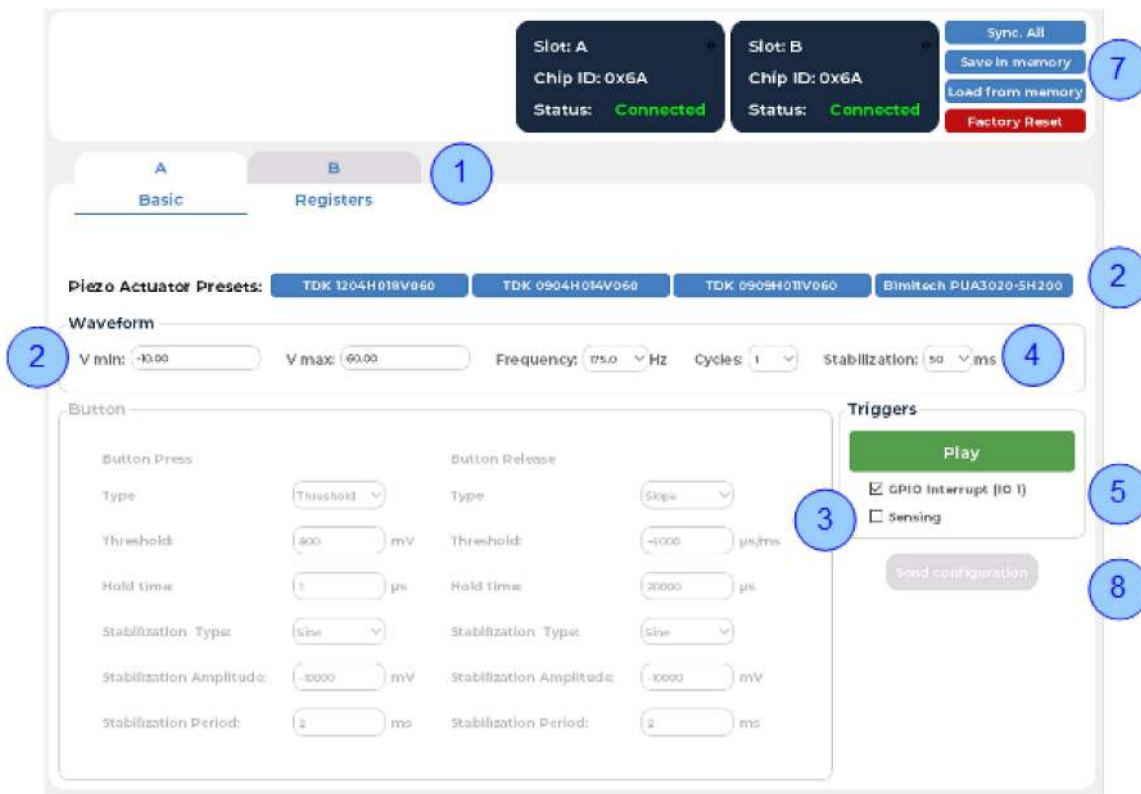

Figure 10: Play waveform – External trigger

### Steps

1. Select the channel tab (A or B)
2. If the board is connected to a piezo actuator supplied in the BOS1901-KIT, click on the corresponding piezo electric preset button to set the voltage operating range ( $V_{min}$  and  $V_{max}$ ). Otherwise, manually set the  $V_{min}$  and  $V_{max}$  fields in the *Waveform* section.
3. In the *Triggers* section, uncheck the *Sensing* checkbox.
4. Configure the waveform:
  - Sinusoidal waveform frequency (between 100.0 and 300.0 hertz)
  - Number of cycles (between 1 and 254)
  - Set the stabilization time (between 0 and 1000 ms)
5. In the *Triggers* section, check the *GPIO interrupt* checkbox.
6. Connect the IO1 on the BOS1901-KIT board to the external signal you want to use to trigger the waveform feedback.

7. On detection of a falling edge of the signal connected on IO1, the waveform feedback will be played on the selected channel.
8. (Optional): Press the save in memory button to persist the configuration of the BOS1901-KIT board in memory.
9. (Optional): If the waveform parameters are changed after the GPIO interrupt box is checked, the *Send configuration* button must be pressed again to send the waveform configuration to the BOS1901-KIT board.

## 8.5.1.4 Play a Waveform – Sync Mode

### Description

User configures the BOS1901-KIT board to play a sinusoidal waveform on both channels simultaneously. The trigger to play the waveform can be manual using the *Play* button from the software or an external signal connected on *IO1*.

### Prerequisites

- Software is connected to the BOS1901-KIT board in *Haptic* mode.

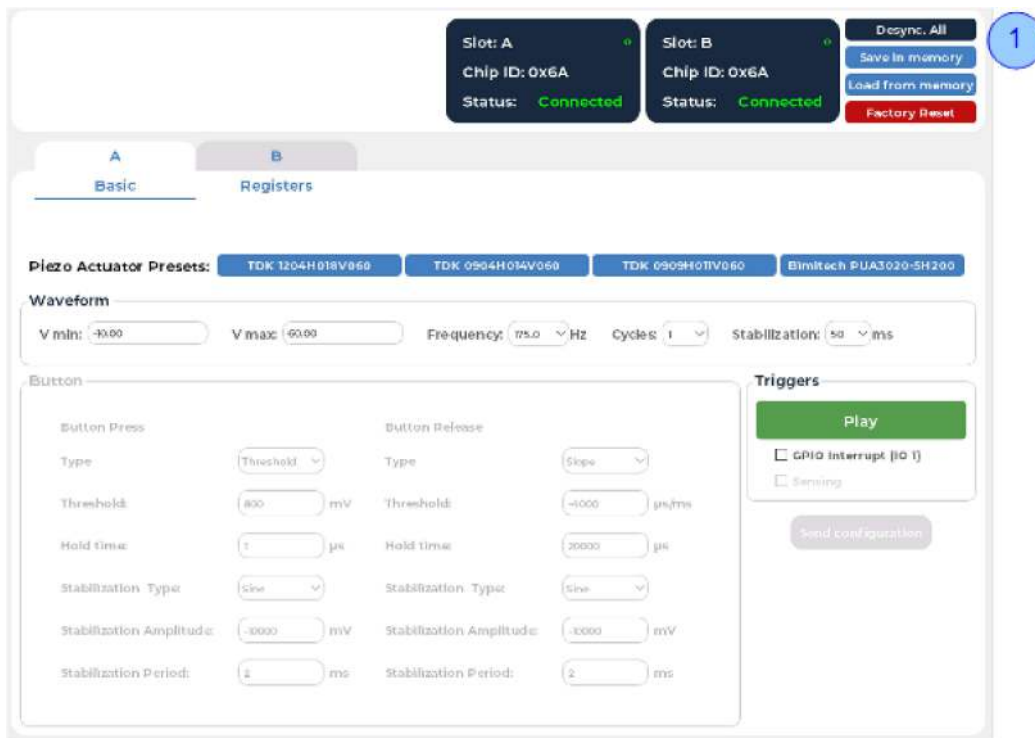

Figure 11: Play waveform – Sync mode

### Steps

1. Press the *Sync. All* button of the top panel to enable the synchronized feedback mode. A little green icon in the chip status panel will be displayed to indicate that the mode is enabled. Also, the text of the *Sync. All* button will be changed to *Desync. All* (Use this new button to disable the sync mode).
2. To play feedback using a manual trigger, follow the procedure Play a Waveform - Manual Trigger. To play feedback using an external trigger, follow the procedure Play a Waveform - External Trigger (GPIO).

**Note:** When the sync mode is enabled, one channel becomes the master (the one in which the sync mode has been enabled). The configuration of the waveform and the trigger can only be done from the master channel.

## 8.5.1.5 Button Emulation Mode

### Description

User configures the parameters of a sinusoidal waveform and the parameters of a sensing algorithm that can detect a button press and button release on the piezo actuator. When these events are detected by the sensing algorithm, the feedback is played on the piezo actuator.

### Prerequisites

- Software is connected to the BOS1901-KIT board in *Haptic* mode.

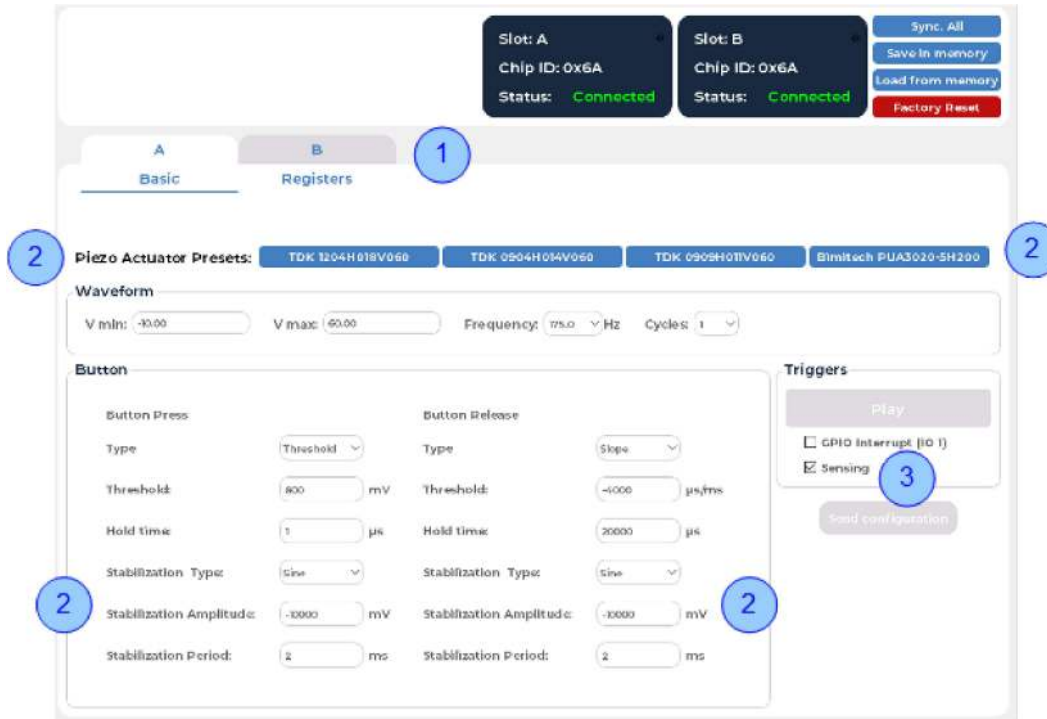

Figure 12: Button emulation

### Steps

1. Select the channel tab (A or B).
2. In the *Triggers* section, check the *Sensing* checkbox to enable the sensing algorithm on the BOS1901-KIT board and the BOS1901 status LED of the channel will turned solid green.
3. If the board is connected to a piezo actuator supplied in the BOS1901-KIT, click on the corresponding piezo electric preset button to set the voltage operating range (*Vmin* and *Vmax*) and the *Sensing* parameters.

Otherwise, manually set the *Vmin* and *Vmax* fields in the *Waveform* section. The *Sensing* parameters values will also have to be calibrated for a good detection of the press and release events. More details regarding the sensing algorithm are given in Appendix A.

4. Gently press the piezo actuator until the press event is detected (user should feel the feedback on his finger). Release the force on the piezo actuator to let the sensing algorithm detect the release event.

**Note:** After the detection of a press, the sensing algorithm waits a maximum of 3 seconds before it returns to the state where it is waiting for the detection of the press event.

## 8.5.1.6 Registers Access

### Description

User read and optionally write registers of the connected BOS1901.

### Prerequisites

- Software is connected to the BOS1901-KIT board in *Haptic* mode.

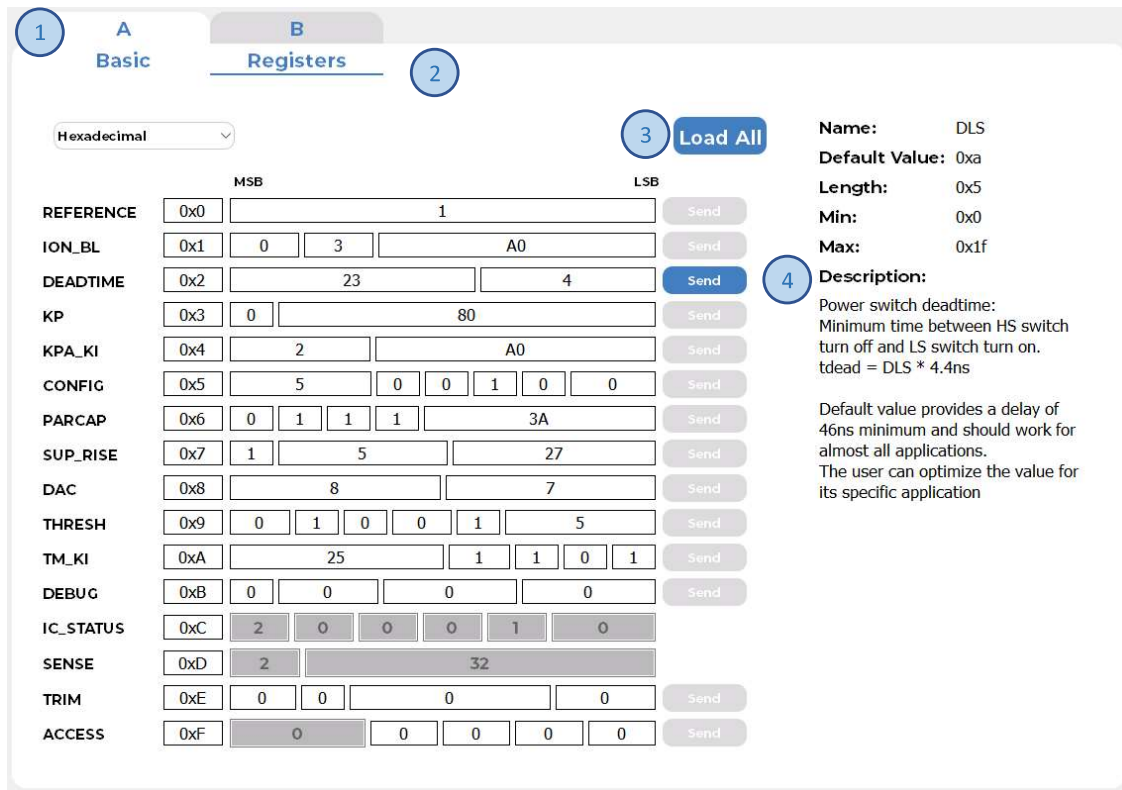

Figure 13: Register access panel

### Steps

1. Select the channel tab (A or B).
2. Select the *Registers* Tab.
3. Use the *Load All* button to read all registers values from the BOS1901
4. (Optional): To change the value of a writable register, edit the parameter you want to change and press the *Send* button to write the modified register in the BOS1901.

**Note:** The registers are displayed, one per line. The register label is given on the left, then the register address, then the parameters for this register are given (MSB on the left, LSB on the right)

When selecting a parameter box, the information for that parameter is given on the right side of the screen. Information includes parameter name, its current value, the number of bits of that parameter (Length), the minimum and maximum possible values, and a short description.

### 8.5.2 Audio Mode

#### 8.5.2.1 Panel Overview

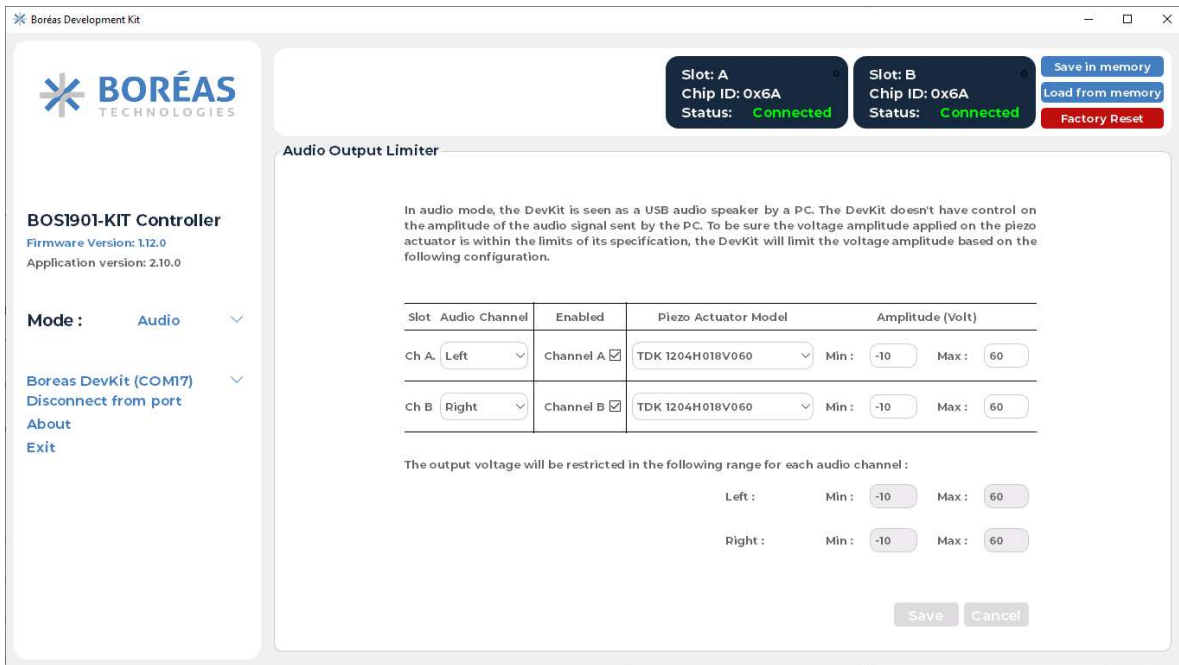

Figure 14: Panel overview - Audio mode

When the BOS1901-KIT board is in *Audio* mode, it is detected by Windows as a speaker device. When this device is selected, all audio output from the PC will be sent to the board. Make sure to deselect the Boreas DevKit to avoid the PC from playing system sounds on the actuator.

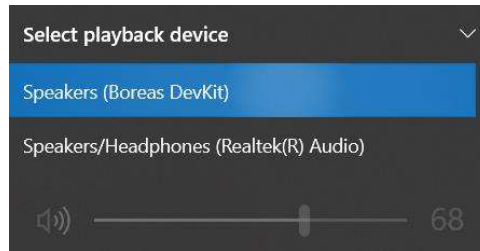

Figure 15: Boreas DevKit speaker

User should use a software that can specifically select an individual USB device as audio output. For example, Audacity® allows to easily create and play waveforms on the piezo actuators attached to the board. See appendix for more details.

#### 8.5.2.2 Channel Configuration

Each channel (A, B) may be configured independently. They may be enabled/disabled using the checkbox and they may be associated with either the Left or Right audio track.

### 8.5.2.3 Audio Limiting

Because some piezo actuators have voltage operating ranges that are smaller than the capacity of the BOS1901, the BOS1901-KIT board has the capacity to limit the voltage range of the audio signal in order to protect the actuator.

**Using the factory default values, the BOS1901-KIT board will limit the output voltage between -10 V and 60 V.** This range is within tolerances of all piezo actuators model supplied in the BOS1901-KIT.

To change the audio limiting configuration, open the BOS1901-KIT software while the board is in audio mode and select the appropriate piezo actuator model. The *Min* and *Max* values of the *Amplitude* field may be changed as desired. Press the *Save* button to send the new values to the BOS1901-KIT. When using different actuators on each channel, the most restrictive range will be used and shown by the greyed *Min* and *Max* values at the bottom of the window.

### 8.5.2.4 Audio Limiting Illustrated

Original signal without audio limiting:

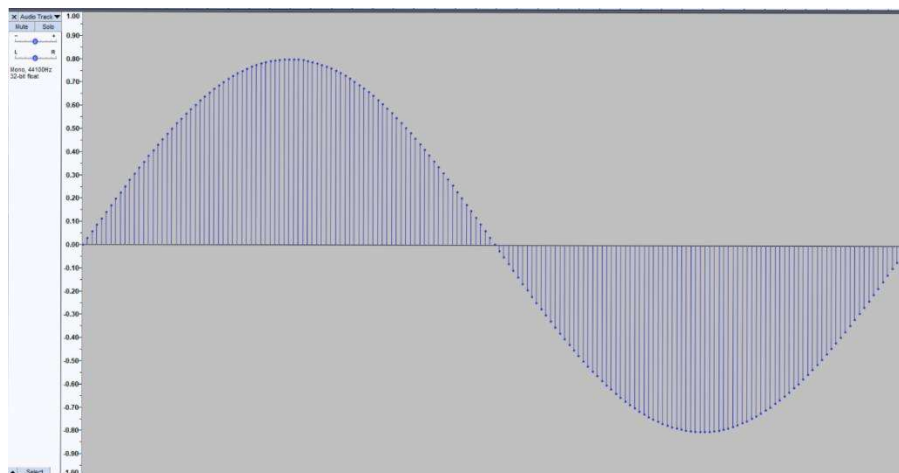

Figure 16:Original audio signal

Same signal with audio limiting set between -10 V to 60 V:

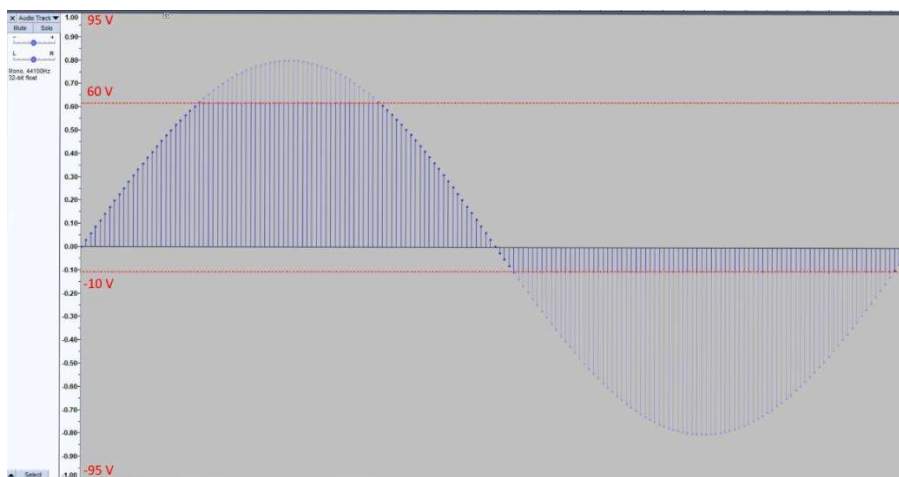

Figure 17:Audio signal with audio limiting

## 8.5.3 IC Status Monitoring

As displayed above, when the application is connected to the BOS1901-KIT board it shows all detected BOS1901 errors in the bottom section of the left panel.

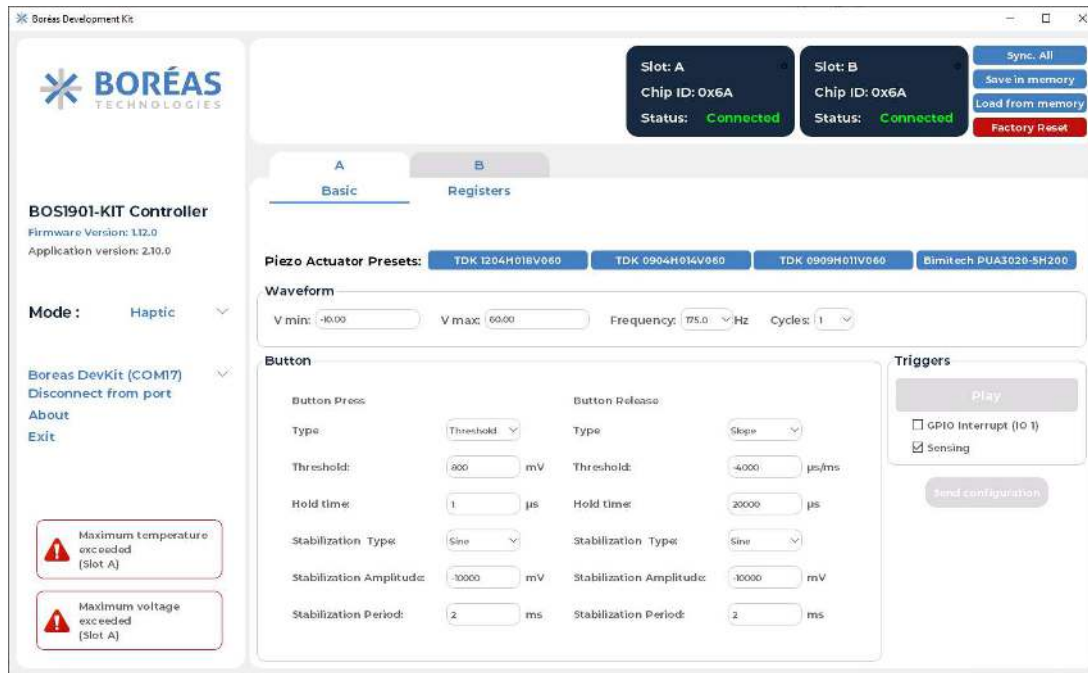

Figure 18 Errors shown in the left panel

### Possible IC errors:

Table 9: BOS1901 errors

Reported Error Message	Meaning
Maximum temperature exceeded (Slot X)	Over temperature detected on the IC. Operation will resume when temperature drops. This error seldom occurs and is indicative of a hardware issue.
Maximum voltage exceeded (Slot X)	Output voltage exceeded the maximum voltage allowed on the IC.



## 9 Hardware

The purpose of this section is to provide information on the hardware design of the BOS1901-KIT PCB to help the integrator evaluate BOS1901 and to use it in a prototype.

### 9.1 Design Overview

The board is composed of two distinct sections: a microcontroller section on the left and a BOS1901 driver section on the right. Each section is clearly demarcated by dotted line which allows to physically separate the two sections if needed. It is for this reason that the terms *breakable section* or *breakable board* are sometimes used to identify the right section of the PCB.

By default, the BOS1901-KIT power supply is supplied by the USB port. However, the hardware design allows for partial or complete electrical isolation of the microcontroller section from the driver section. This is made possible by the presence level shifter circuit on the SPI and GPIO, an external supply connector to power the BOS1901 driver section and a series of solder bridges that can be populated or unpopulated with resistance to do the configuration.

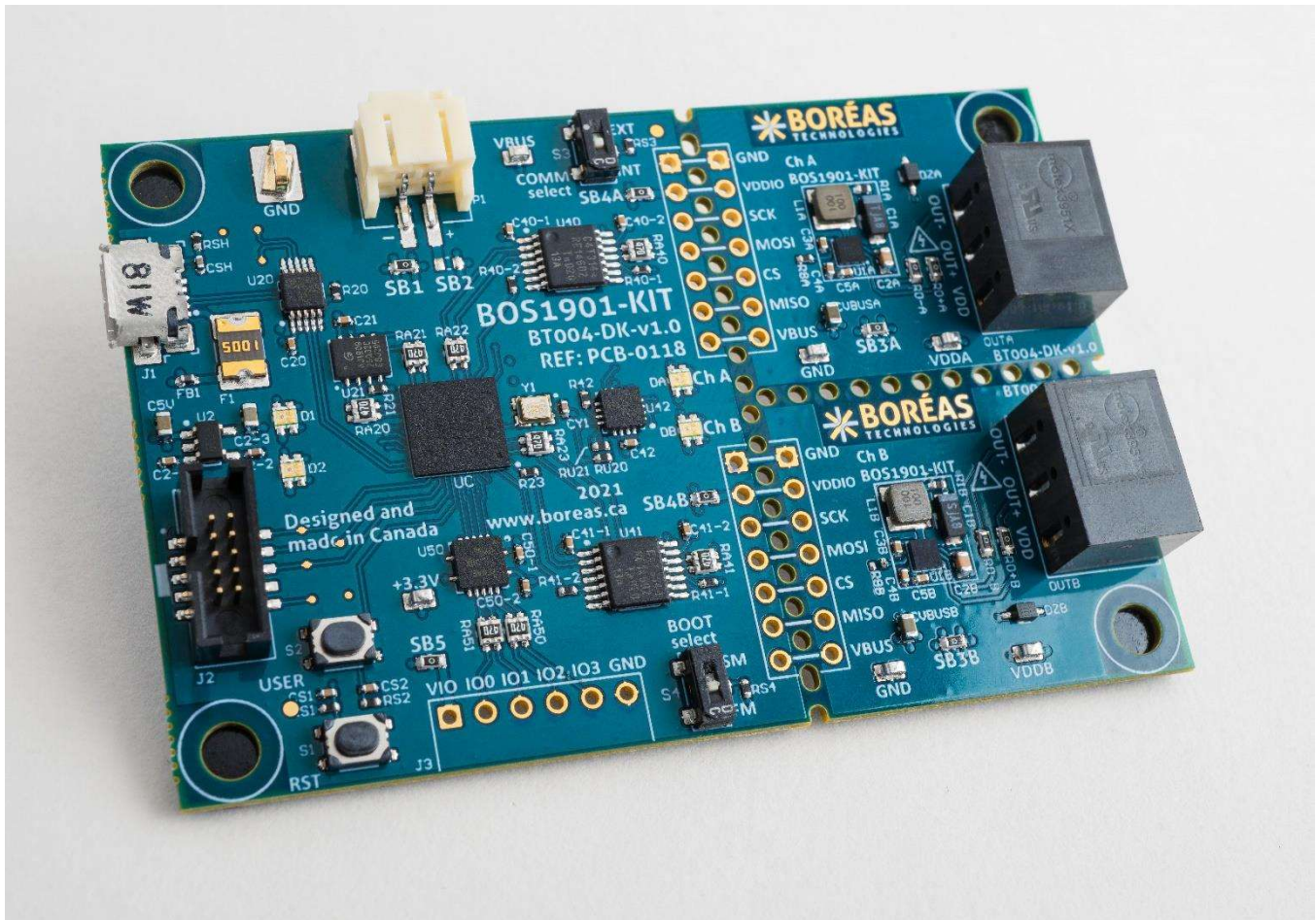

Figure 19: BOS1901-KIT PCB overview

## 9.2 Hardware Features

In this section, we will discuss the various hardware configurations. Except for section 9.2.1, it is assumed that the microcontroller section and the driver section have not been separated.

Some functionality in this section requires modifications to the PCB and requires a soldering iron. Disconnect the supply before making any changes to the board.

### 9.2.1 Breakable Driver Section

**The use of the breakable units with custom-made firmware is done at the user's own risk of causing damage beyond repair to the BOS1901 circuit. Boréas Technologies will not be held responsible.**

One way to integrate a BOS1901 is to break the driver section and connect it to your development platform. A few strokes using an exacto knife on the dotted line will help to split the PCB.

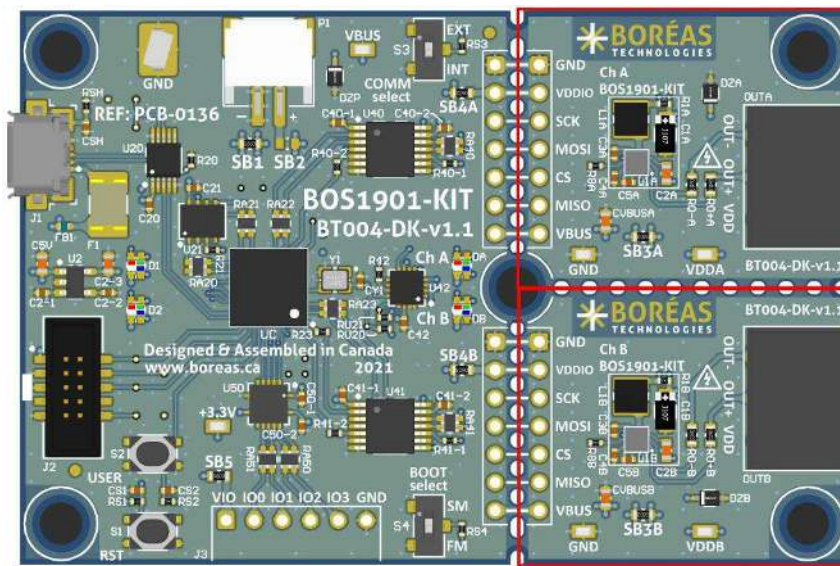

Figure 20: Breakable section location

Each breakable PCB contains a BOS1901 that can be used alone with a user-preferred development platform. All signals need to be connected to your development platform.

Table 10: Breakable Driver Section signals

Signal	Description	Constraint
GND	0 V reference	
VDDIO	Digital IO power supply	Digital signals voltage domain. Must be between 1.62 V and 5.5 V.
SCK	SPI Clock signal	
MOSI	SPI Master Out/Slave In signal	
CS	SPI Chip Select signal	Active low signal
MISO	SPI Master In/Slave Out signal	
VBUS	Main power supply for the BOS1901	Supply voltage between 3.0 V and 5.5 V with at least 500 mA current drive.

Refer to BOS1901 datasheet for a complete description on how to use and program the circuit.

## 9.2.2 Probe Hooks

Probe hooks are available around the board to ease connection of instruments for measurement of supplies when debugging. At the separation line between the microcontroller section on the left and the driver section on the right lies a header pins connector. This connector allows to probe supply levels and SPI communication digital.

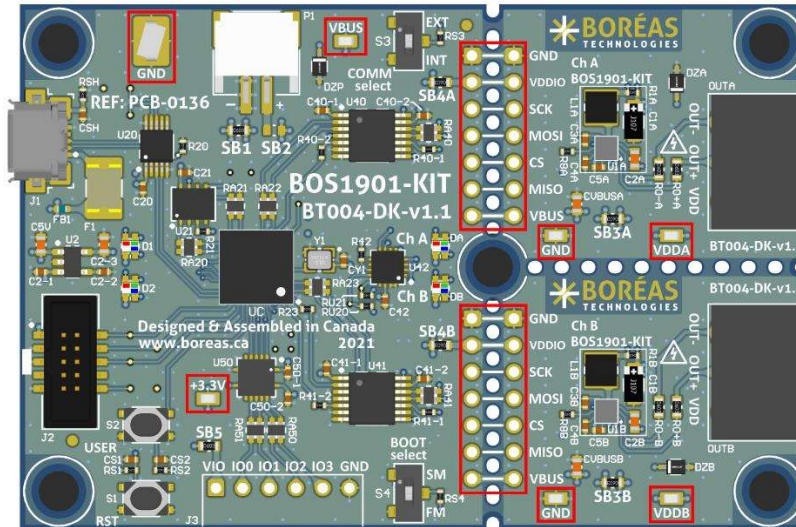

Figure 21: Probe hook location

## 9.2.3 Digital GPIOs

General-purpose inputs and outputs (GPIOs) are provided to ease integration of the development kit in a prototype. For example, digital inputs may be used as trigger inputs to fire the waveforms or to send information from the system to the development kit. Four pins can be configured as input or output.

Using these GPIOs implies to modify the firmware to support them. However, they are already physically implemented and routed to the MCU. They need to be activated in the firmware software code project.

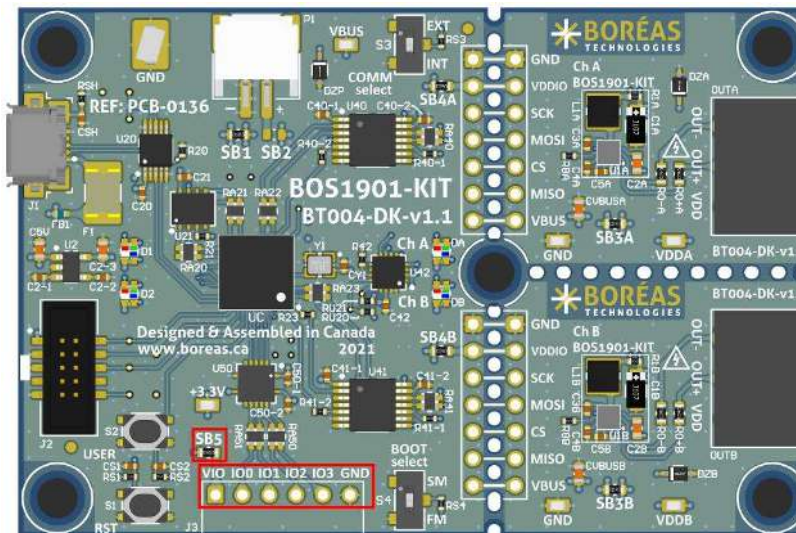

Figure 22: GPIOs and GPIOs supply voltage configuration solder bridge location

By default, the GPIOs are in the microcontroller 3.3 V supply domain. To use these GPIOs with a system operating in another voltage domain requires modification of the BOS1901-KIT PCB configuration.

Table 11: GPIOs supply voltage solder bridge configuration

GPIOs Supply Source	SB5 State
+3.3V (MCU supply)	Populated
VIO (3.3 V to 5.5 V)	Unpopulated

When SB5 is unpopulated, GPIOs supply voltage is provided by VIO and GND of the J3 connector. This J3 header connector is provided in the box but is not initially populated. Refer to the board schematics in section 10.1 for MCU pins numbers corresponding to IO0, IO1, IO2 and IO3.

## 9.2.4 External SPI

The BOS1901 features an SPI communication interface. By default, each BOS1901 are connected to the MCU SPI master. It is possible to bypass the MCU and use an external SPI master without breaking the board. This can be useful when trying to connect a BOS1901 directly to an external system.

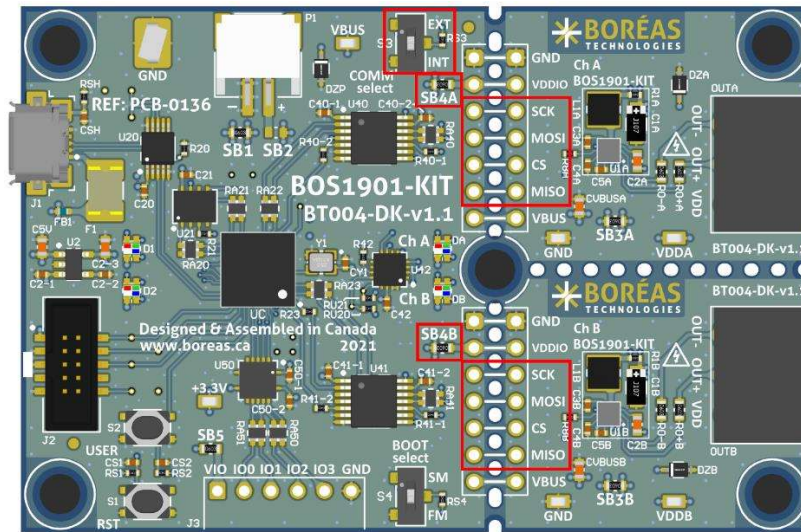

Figure 23: Comm selection switch and SPI header location

To use an external SPI, it is mandatory to enable it using the COMM Select switch on the board by setting it to EXT position. USB port must still be connected since it supplies the digital switches.

By default, the SPIs are in the microcontroller 3.3 V supply domain. To use these SPIs with a system operating in another voltage domain requires modification of the BOS1901-KIT PCB configuration.

Table 12: SPIs supply voltage solder bridge configuration

SPI Supply Source	SB4 State
+3.3V (MCU supply)	Populated
VDDIO (1.62 V to 5.5 V)	Unpopulated

When SB4 is unpopulated, SPI supply voltage is provided by VDDIO and GND of the external SPI header connectors. The external SPI header connectors are provided in the box but is not initially populated.

## 9.2.5 Power Supply Source and UPI Mode Operation

The driver section of the PCB can be supplied using two different sources: the USB connector and the P1 white connector. By default, the USB connector is the power source, and UPI mode is disabled.

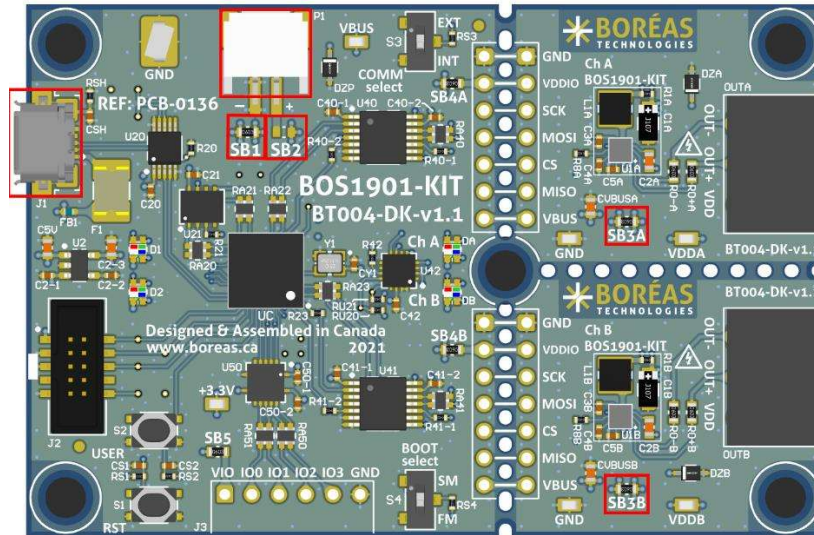

Figure 24: Driver power supply and UPI mode configuration resistors location

Table 13: Driver power supply and UPI mode configuration options

Driver Section Supply Source	UPI Mode	Bridge State		
		SB1	SB2	SB3
USB connector	Disable	Populated	Unpopulated	Populated
USB connector	Enable	Populated	Unpopulated	Unpopulated
P1 connector	Disable	Unpopulated	Populated	Populated
P1 connector	Enable	Unpopulated	Populated	Unpopulated

Depending on the desired power source and UPI mode configuration, add or remove the resistors on SB1, SB2 and SB3 as indicated in the above table.

Refer to the board schematics in section 10.1 to obtain more information regarding the power supply options. Refer to the BOS1901 datasheet to get more information regarding the UPI mode.

## 9.2.6 Piezo Actuator Low-Pass Filter

Two 0603 resistors ROx are in series with each BOS1901 output channels OUTx. They can be used to create a low-pass filter with the actuator and filter out audible noise. Resistor values to use are determined by the desired cut-off frequency and the actuator capacitance. A bode plot is useful to assess the amplitude attenuation at the waveform frequency in order to compensate it in the programmed voltage waveform. Initially, the populated values are 0 ohm.

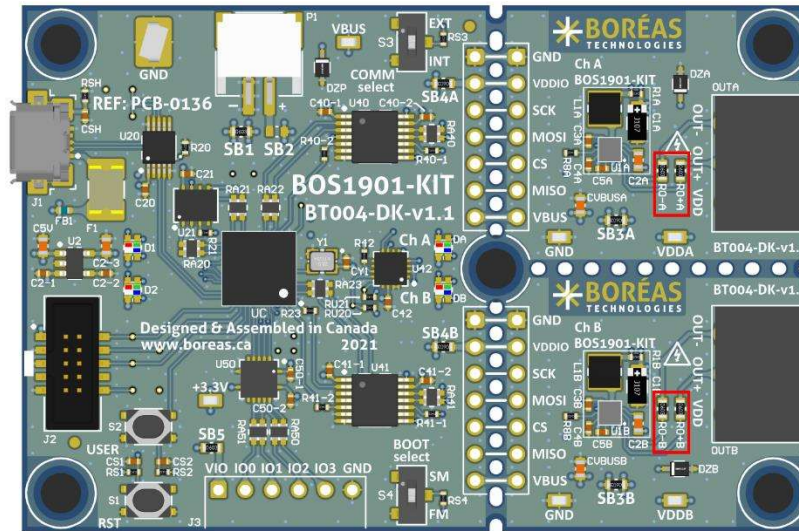

Figure 25: Low-pass filter resistors location

## 9.3 Piezo Actuators

One TDK actuator is provided with the BOS1901-KIT **Starter Set**, but it is compatible with many actuators.. For many piezoelectric actuator available, Boréas provides recommended presets. Each preset is available in the GUI and is identified by the brand and model number of the piezo actuator.

### 9.3.1 Bimitech Actuator

#### ***Bimitech PUA3020-5H200 piezo actuator specifications:***

Type	Bender
Polarity	Red wire on "OUT+" terminal Black wire on "OUT-" terminal
Range	-90 V to +160 V

### 9.3.2 TDK Actuator

#### ***TDK PowerHap™ 0909H011V060 piezo actuator specifications:***

Type	Cymbal design
Polarity	Red wire on "OUT+" terminal Black wire on "OUT-" terminal
Range	Unipolar -10 V to +60 V

#### ***TDK Mini PowerHap™ 1204H018V060 specifications:***

Type	Cymbal design
Polarity	Red wire on "OUT+" terminal Black wire on "OUT-" terminal
Range	Unipolar -10 V to +60 V

#### ***TDK Mini PowerHap™ 0904H014V060 specifications:***

Type	Cymbal design
Polarity	Red wire on "OUT+" terminal Black wire on "OUT-" terminal
Range	Unipolar -10 V to +60 V

**It is of utmost importance to not use the TDK PowerHap™ actuators outside their specified ranges as they can get damaged unless the waveform is properly designed to limit the output voltage between -10 V and +60 V. Example waveforms are provided on Boréas website ([www.boreas.ca/bos1901-kit](http://www.boreas.ca/bos1901-kit)).**

## 10 Design Reference

### 10.1 Schematics

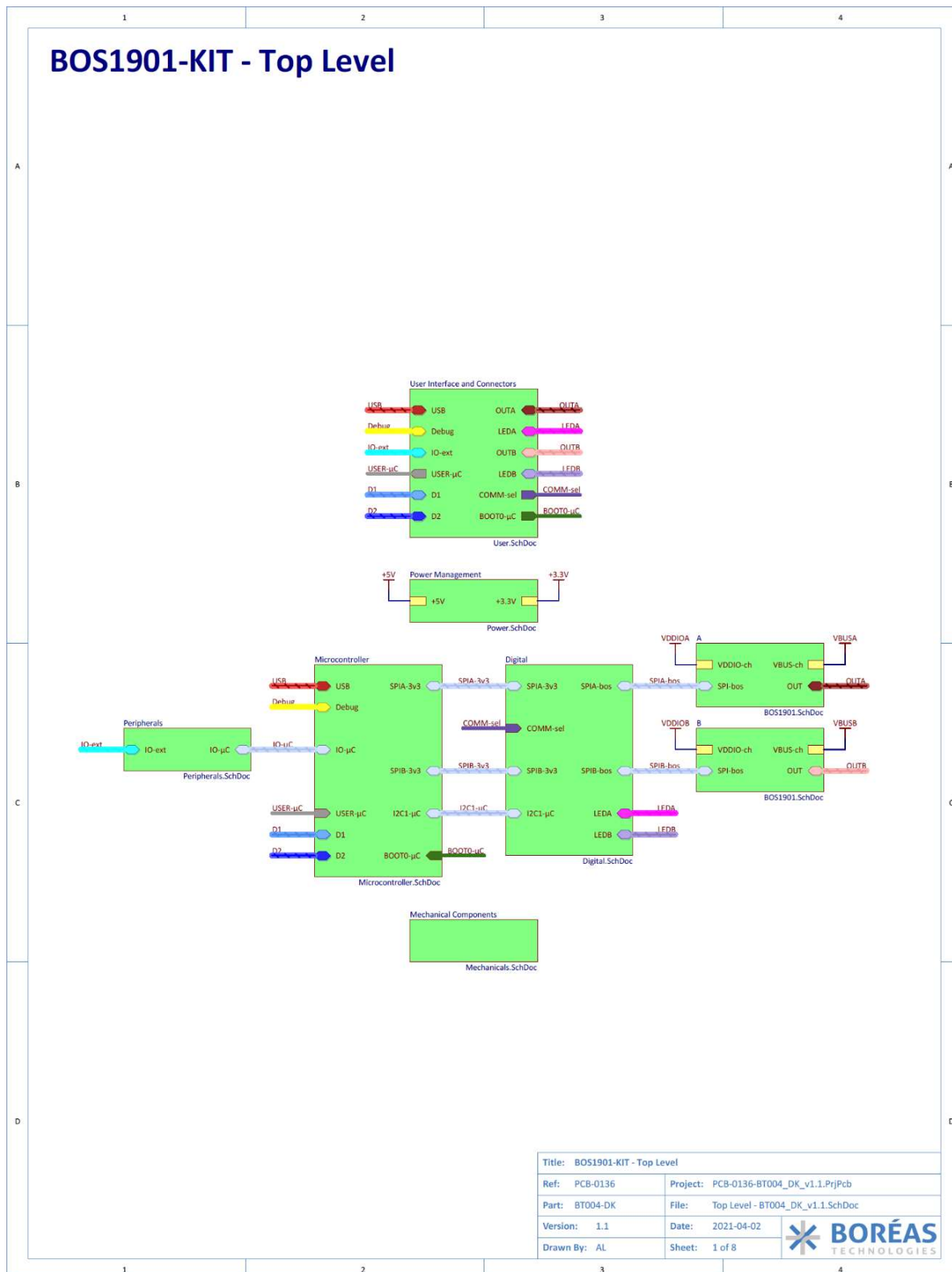



### BOS1901-KIT - User Interface and Connectors

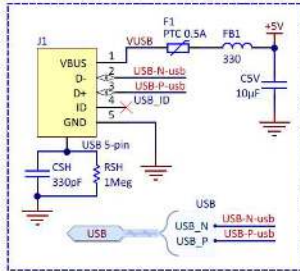

USB Connector

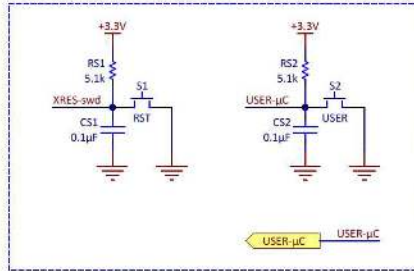

Reset and User buttons (with hardware debouncing)

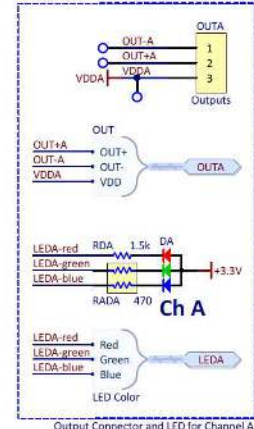

Output Connector and LED for Channel A

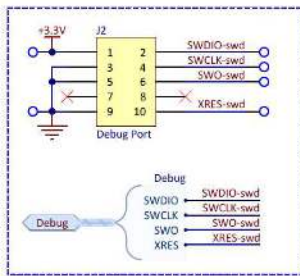

Debug/Programming Connector

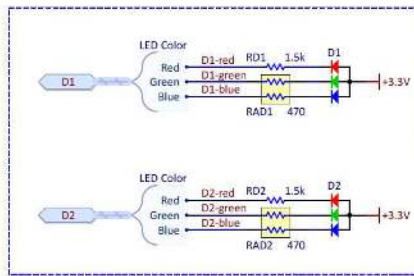

Software LEDs

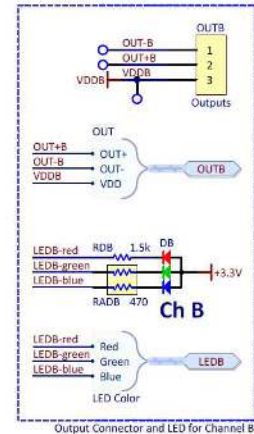

Output Connector and LED for Channel B

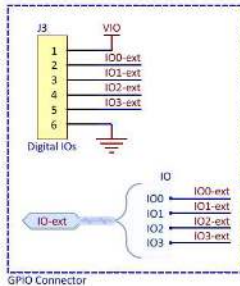

GPIO Connector

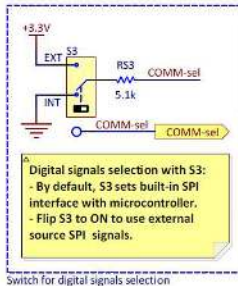

Digital signals selection with S3: - By default, S3 sets built-in SPI interface with microcontroller. - Flip S3 to ON to use external source SPI signals.

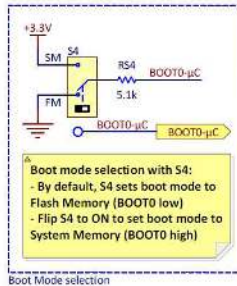

Boot mode selection with S4: - By default, S4 sets boot mode to Flash Memory (BOOT0 low) - Flip S4 to ON to set boot mode to System Memory (BOOT0 high)

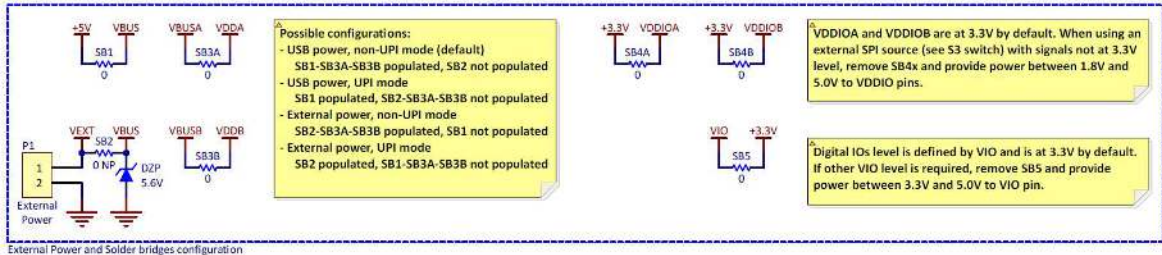

External Power and Solder bridges configuration

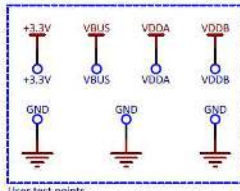

User test points

Title: BOS1901-KIT - User Interface and Connectors	
Ref: PCB-0136	Project: PCB-0136-BT004_DK_v1.1.PrjPcb
Part: BT004-DK	File: User.SchDoc
Version: 1.1	Date: 2021-04-02
Drawn By: AL	Sheet: 2 of 8

### BOS1901-KIT - Power Management

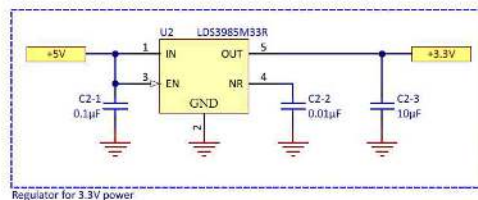

Title: BOS1901-KIT - Power Management	
Ref: PCB-0136	Project: PCB-0136-BT004_DK_v1.1.PrjPcb
Part: BT004-DK	File: Power.SchDoc
Version: 1.1	Date: 2021-04-02
Drawn By: AL	Sheet: 3 of 8



### BOS1901-KIT - Microcontroller

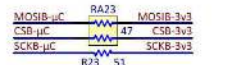
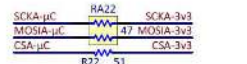
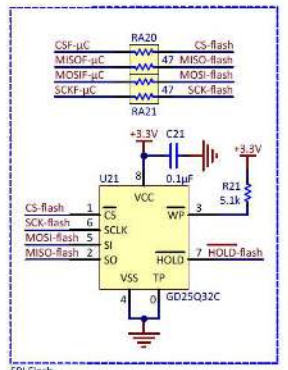
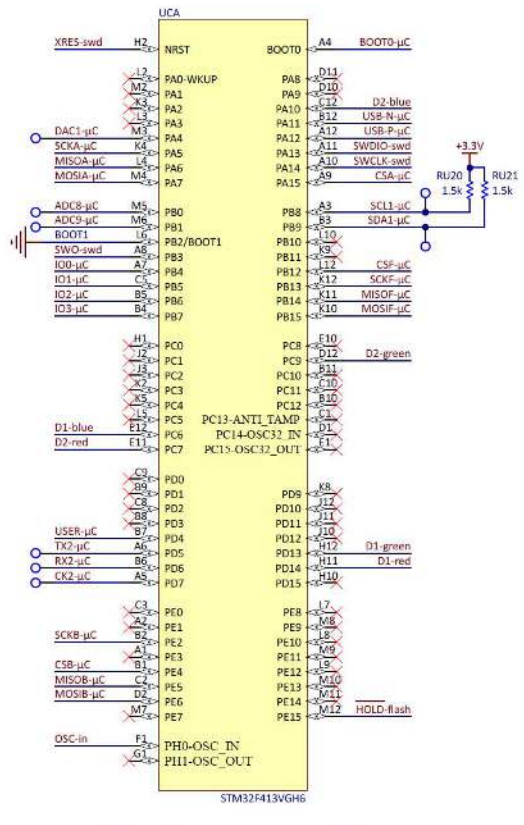
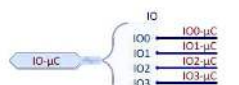
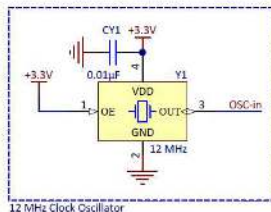
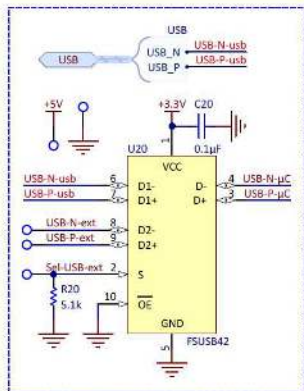

Title: BOS1901-KIT - Microcontroller	
Ref: PCB-0136	Project: PCB-0136-BT004_DK_v1.1.PrjPcb
Part: BT004-DK	File: Microcontroller.SchDoc
Version: 1.1	Date: 2021-04-02
Drawn By: AL	Sheet: 4 of 8

### BOS1901-KIT - Digital signals conditioning and LED driver

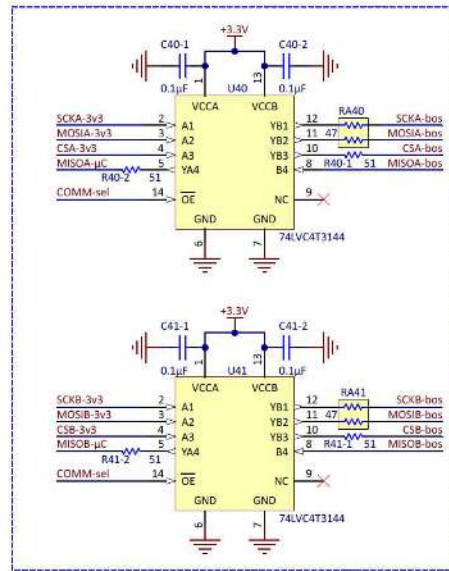
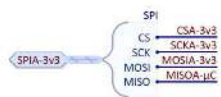

SPI signals buffers

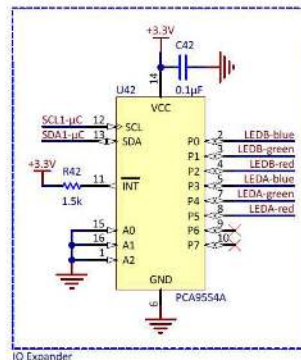

IO Expander



Title: BOS1901-KIT - Digital signals conditioning and LED driver	
Ref: PCB-0136	Project: PCB-0136-BT004_DK_v1.1.PrjPcb
Part: BT004-DK	File: Digital_SchDoc
Version: 1.1	Date: 2021-04-02
Drawn By: AL	Sheet: 5 of 8

# BOS1901-KIT - BOS1901 unit

VDDIO-ch VDDIO-ch

SPI  
 CS CS-bos  
 SCK SCK-bos  
 MOSI MOSI-bos  
 MISO MISO-bos

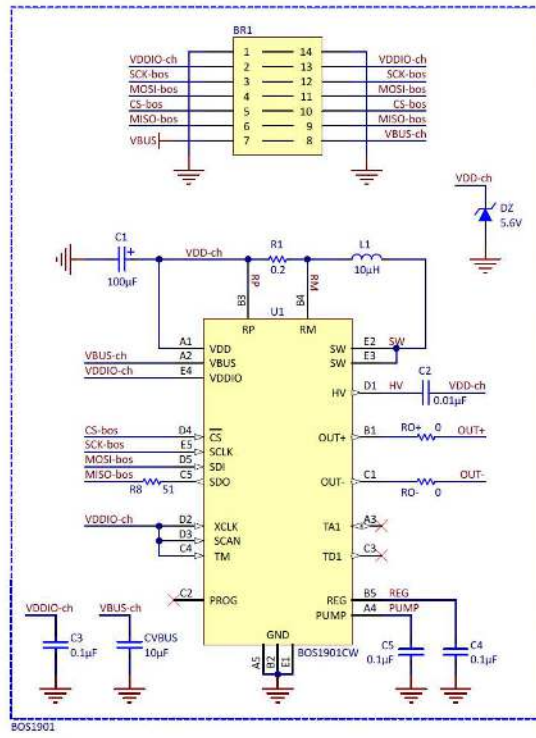

VBUS-ch VBUS-ch

OUT+ OUT+  
 OUT- OUT-  
 VDD-ch VDD

Title: BOS1901-KIT - BOS1901 unit	
Ref: PCB-0136	Project: PCB-0136-BT004_DK_v1.1.PrjPcb
Part: BT004-DK	File: BOS1901.SchDoc
Version: 1.1	Date: 2021-04-02
Drawn By: AL	Sheet: 6 of 8

## BOS1901-KIT - Peripherals

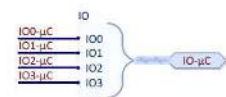
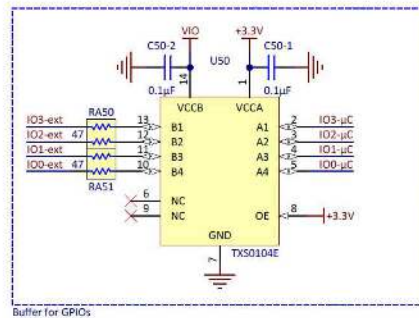
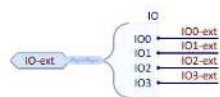

Buffer for GPIOs

Title: BOS1901-KIT - Peripherals	
Ref: PCB-0136	Project: PCB-0136-BT004_DK_v1.1.PrjPcb
Part: BT004-DK	File: Peripherals.SchDoc
Version: 1.1	Date: 2021-04-02
Drawn By: AL	Sheet: 7 of 8

# BOS1901-KIT - Mechanical Components

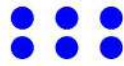

Fiducials



Bumpers



Logos

- List of changes:
- Updated database components
  - Added test point on BOOT0
  - Modified separation with teardrops
  - Added bumper in PCB middle

Title: BOS1901-KIT - Mechanical Components	
Ref: PCB-0136	Project: PCB-0136-BT004_DK_v1.1.PrjPcb
Part: BT004-DK	File: Mechanicals.SchDoc
Version: 1.1	Date: 2021-04-02
Drawn By: AL	Sheet: 8 of 8



## 10.2 PCB Layout

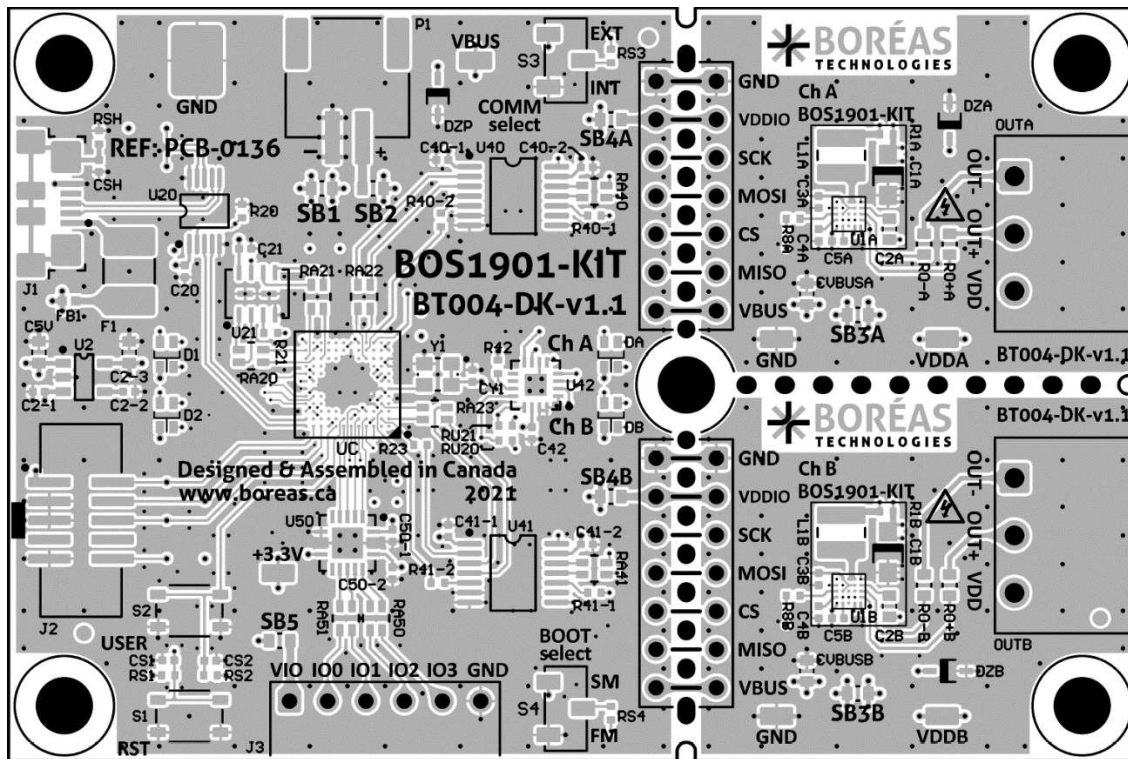

Figure 26: Layout view - Top Overlay (not to scale)

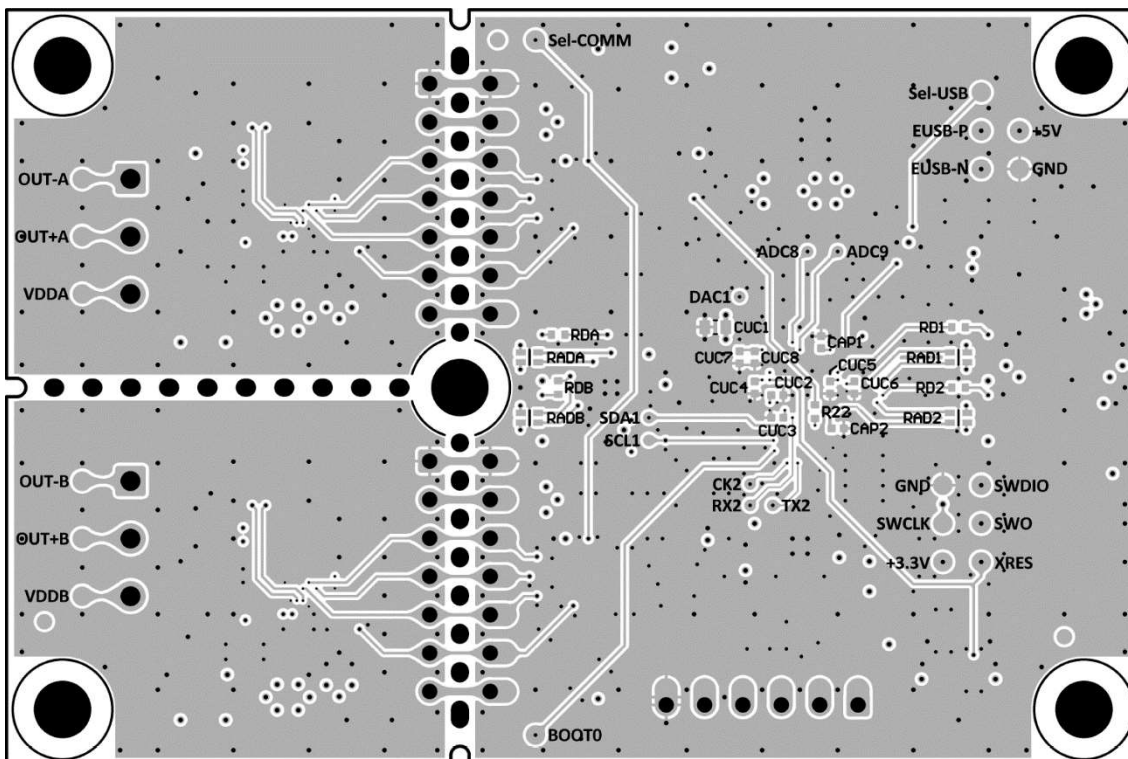

Figure 27: Layout view - Top Layer (not to scale)



## 10.3 Bill of Materials

The following is a list of the components that populate the evaluation PCB. Due to availability, some components with equivalent performance/characteristics may be installed on the actual evaluation PCB. If the exact part number is not available, the components can be replaced by ones with equivalent package and specifications.

Table 14: Bill of Materials for BOS1901-BRD-C02-B1

DESIGNATOR	QTY	VALUE	DESCRIPTION	MANUFACTURER	PART NUMBER
BUMP1, BUMP2, BUMP3, BUMP4, BUMP5	5	-	BUMPER CYLINDRICAL 0.25" DIA BLK	Keystone Electronics	783-B
C1A, C1B	2	100µF	CAP TANT POLY 100UF 6.3V 1206	KEMET	T527I107M006ATE070
C2-1, C3A, C3B, C4A, C4B, C5A, C5B, C20, C21, C40-1, C40-2, C41-1, C41-2, C42, C50-1, C50-2, CS1, CS2, CUC2, CUC3, CUC4, CUC5, CUC6, CUC8	24	0.1µF	CAP CER 0.1UF 25V X5R 0402	Taiyo Yuden	TMK105BJ104KV-F
C2-2, CY1	2	0.01µF	CAP CER 10000PF 50V X7R 0402	Taiyo Yuden	UMK105B7103KV-F
C2-3, C5V, CUC1, CVBUSA, CVBUSB	5	10µF	CAP CER 10UF 25V X5R 0603	Taiyo Yuden	TMK107BBJ106MA-T
C2A, C2B	2	0.01µF	CAP CER 10000PF 250V X7R 0603	Würth Elektronik	885342206006
CAP1, CAP2	2	2.2µF	CAP CER 2.2UF 16V X5R 0402	Taiyo Yuden	EMK105ABJ225KV-F
CSH	1	330pF	CAP CER 330PF 250V COG/NP0 0402	KEMET	C0402C331JAGACAUTO
CUC7	1	1µF	CAP CER 1UF 16V X5R 0402	TDK Corporation	CGB2A1X5R1C105K033BC
D1, D2, DA, DB	4	-	LED RGB 0606 SMD	Dialight	5977715607F
DZA, DZB, DZP	3	5.6V	DIODE ZENER 5.6V 500MW SOD-323F	Rohm Semiconductor	UFZVFHTE-175.6B
F1	1	0.5A	PTC RESET FUSE 15V 500MA 1812	Schurter Inc.	PFMF.050.2
FB1	1	330	FERRITE BEAD 330 OHM 0402 1LN	Murata Electronics	BLM15PX331SN1D
J1	1	-	CONN RCPT USB2.0 MICRO B SMD R/A	Hirose Electric Co Ltd	ZX62R-B-5P(30)

DESIGNATOR	QTY	VALUE	DESCRIPTION	MANUFACTURER	PART NUMBER
J2	1	-	CONN HEADER SMD 10POS 1.27MM	CNC Tech	3221-10-0300-00-TR
J3 *	1	-	CONN HEADER R/A 6POS 2.54MM	Würth Elektronik	61300611021
L1A, L1B	2	10µH	FIXED IND 10UH 1.2A 322 MOHM SMD	Würth Elektronik	74438336100
OUTA, OUTB	2	-	TERM BLOCK HDR 3POS 90DEG 3.81MM	Molex	0395121003
P1	1	-	CONN HEADER SMD R/A 2POS 2MM	JST Sales America Inc.	S2B-PH-SM4-TB(LF)(SN)
R1A, R1B	2	0.2	RES 0.2 OHM 1% 1/8W 0402	TE Connectivity Passive Product	RLP73N1ER20FTDF
R8A, R8B, R22, R23, R40-1, R40- 2, R41-1, R41-2	8	51	RES SMD 51 OHM 5% 1/10W 0402	Panasonic Electronic Components	ERJ-2GEJ510X
R20, R21, RS1, RS2, RS3, RS4	6	5.1k	RES SMD 5.1K OHM 5% 1/10W 0402	Panasonic Electronic Components	ERJ-2GEJ512X
R42, RD1, RD2, RDA, RDB, RU20, RU21	7	1.5k	RES SMD 1.5K OHM 5% 1/16W 0402	Yageo	AC0402JR-071K5L
RA20, RA21, RA22, RA23, RA40, RA41, RA50, RA51	8	47	RES ARRAY 2 RES 47 OHM 0606	Panasonic Electronic Components	EXB-V4V470JV
RAD1, RAD2, RADA, RADB	4	470	RES ARRAY 2 RES 470 OHM 0404	Panasonic Electronic Components	EXB-24V471JX
RO+A, RO+B, RO- A, RO-B, SB1, SB3A, SB3B, SB4A, SB4B, SB5	10	0	RES SMD 0 OHM JUMPER 1/10W 0603	Yageo	RC0603JR-070RL
RSH	1	1Meg	RES SMD 1M OHM 1% 1/16W 0402	Yageo	RC0402FR-071ML
S1, S2	2	-	SWITCH TACTILE SPST- NO 0.05A 16V	Würth Elektronik	434133025816
S3, S4	2	-	SWITCH SLIDE SPDT 100MA 6V	Nidec Copal Electronics	CAS-120TA
TP3V3, TPGND1, TPGND2, TPVBUS1, TPVDDA1, TPVddb1	6	-	PC TEST POINT NATURAL	Harwin Inc.	S2761-46R
TPGND3	1	-	PC TEST POINT COMPACT	Keystone Electronics	5016
U1A, U1B	2	-	PIEZO HAPTIC DRIVER 190V	Boreas Technologies	BOS1901CW

DESIGNATOR	QTY	VALUE	DESCRIPTION	MANUFACTURER	PART NUMBER
U2	1	-	IC REG LINEAR 3.3V 300MA SOT23-5	STMicroelectronics	LDS3985M33R
U20	1	-	IC USB SWITCH DPDT 10MSOP	ON Semiconductor	FSUSB42MUX
U21	1	-	IC FLASH 32MBIT SPI/QUAD 8USON	GigaDevice Semiconductor (HK) Limited	GD25Q32CNIGR
U40, U41	2	-	IC BUF NON-INVERT 5.5V 14TSSOP	Nexperia USA Inc.	74LVC4T3144PW-Q10J
U42	1	-	IC I/O EXPANDER I2C 8B 16QFN	Texas Instruments	PCA9554ARGTR
U50	1	-	IC TRNSLTR BIDIRECTIONAL 14VQFN	Texas Instruments	TXS0104ERGYRG4
UC	1	-	IC MCU 32BIT 1MB FLASH 100UFBGA	STMicroelectronics	STM32F413VGH6
Y1	1	12 MHz	XTAL OSC XO 12.0000MHZ CMOS SMD	Kyocera International Inc. Electronic Components	KC2520Z12.0000C15XXK

\* These components are not populated on the PCB, the proposed part numbers are for reference only.

Table 15: Bill of Materials for BOS1901-BRD-C02-B2 (unlisted components are the same as BOS1901-BRD-C02-B1)

DESIGNATOR	QTY	VALUE	DESCRIPTION	MANUFACTURER	PART NUMBER
U21	1	-	IC FLASH 16MBIT SPI/QUAD 8USON	Winbond Electronics	W25Q16JVUIQ TR

## 11 FAQ and Troubleshooting

Please refer to Boréas website for FAQ and Troubleshooting information, which will be maintained throughout the BOS1901-KIT lifecycle. It will also contain application note documents that will be helpful for the user writing his/her own code to operate the BOS1901.

## 12 Notice and Warning

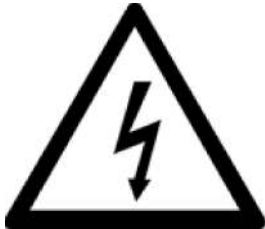

### **Danger High Voltage!**

Electric shock possible when connecting board to live wire. Board should be handled with care by a professional. For safety, use of isolated test equipment with overvoltage and/or overcurrent protection is highly recommended.



This product uses semiconductors that can be damaged by electrostatic discharge (ESD). When handling, care must be taken so that the devices are not damaged. Damage due to inappropriate handling is not covered by the warranty.

### **The following precautions must be taken:**

- Do not open the protective conductive packaging until you have read the following and are at an approved anti-static workstation.
- Use a conductive wrist strap attached to a good earth ground.
- If working on a prototyping board, use a soldering iron or station that is marked as ESD-safe.
- Always disconnect the microcontroller from the prototyping board when it is being worked on.
- Always discharge yourself by touching a grounded bare metal surface or approved anti-static mat before picking up an ESD - sensitive electronic component.
- Use an approved anti-static mat to cover your work surface.

### **Oscilloscope measurements:**

Both OUT+ and OUT- are active outputs. When measuring these signals using an oscilloscope, use a separate probe on each output. Never connect the ground of a probe to one of these outputs. Doing so might damage the BOS1901-KIT and/or your oscilloscope. For more information, please consult the *Probing BOS1901 with an Oscilloscope* application note available for download on <https://www.boreas.ca/pages/support>.

## 13 Ordering Information

Table 16: Ordering information

	ORDERABLE DEVICE	PACKAGE	PACKING FORMAT	STANDARD QUANTITY	ACTUATORS	ROHS COMPLIANT
1	BOS1901-KIT-B02 (Starter Set)	Entire PCB 75x50 mm Breakout PCB 30x25 mm	Box (5 <sup>1/4</sup> x3 <sup>1/2</sup> x1 <sup>1/4</sup> )"	1/box 2 Channels 1 Actuator	TDK PowerHap™ 1204 Lateral	Yes

## 14 Document History

ISSUE	DATE	Document Number	CHANGES
4	February 2023	BT001FUG01.01	Removed Premium Set (obsolete). Updated External Trigger edge detection and debounce time.
3	November 2021	BT001DDK04.03	Updated GUI interface. Added sensing parameters and updated default values for actuators.

## Appendix A. Button Emulation: Sensing Algorithm

The purpose of this section is to provide more details about the algorithm used for the detection of press and release events on the piezoelectric actuator. The parameters of the graphical user interface are represented in this diagram in *italics>*.

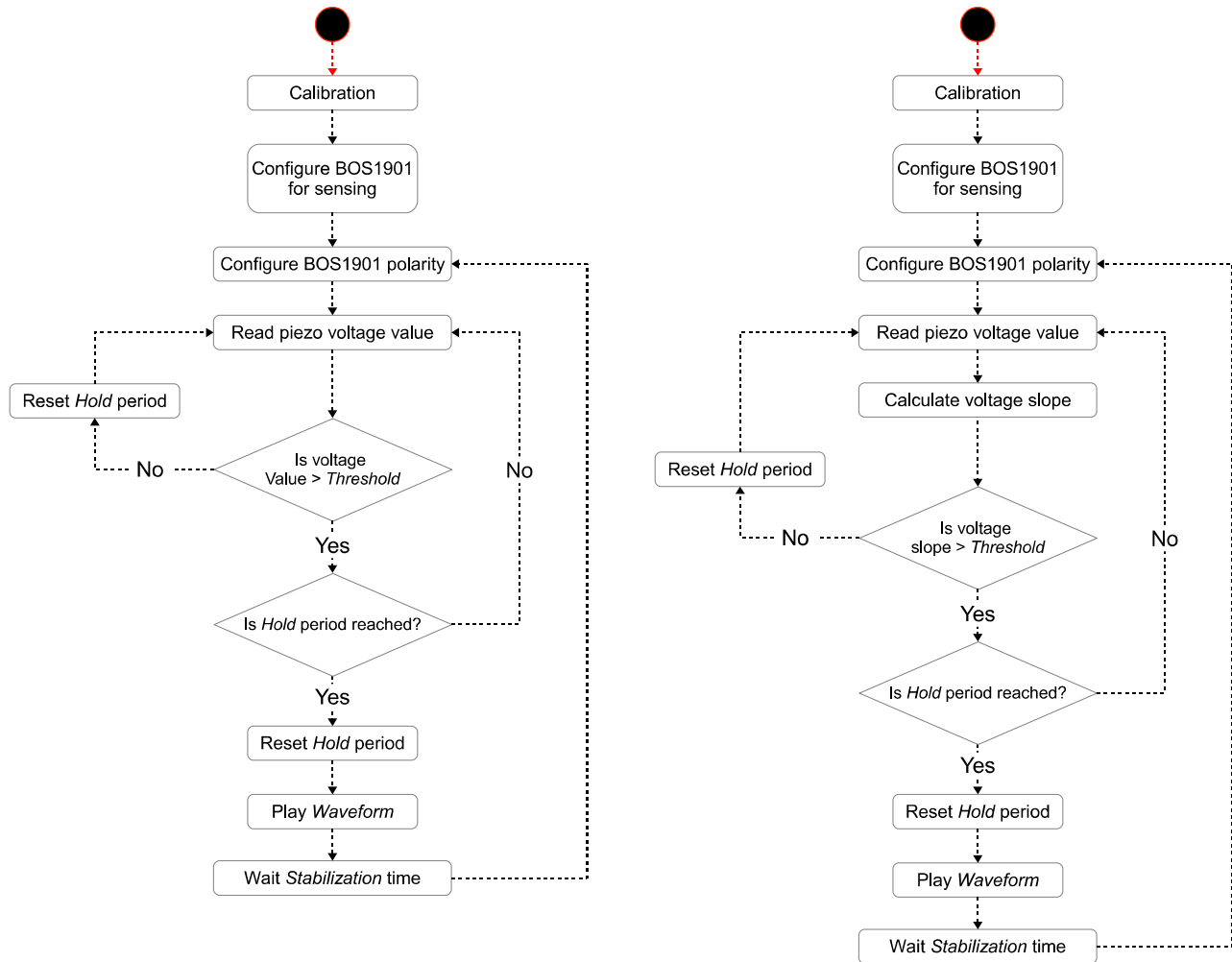

Figure 28: Threshold (left) and slope (right) sensing algorithm flow charts

This image shows the differential voltage between both terminals of the piezoelectric actuator during a press event and feedback. On this scale it is impossible to see the details of the press event because it occurs at much lower voltages and over a longer period.

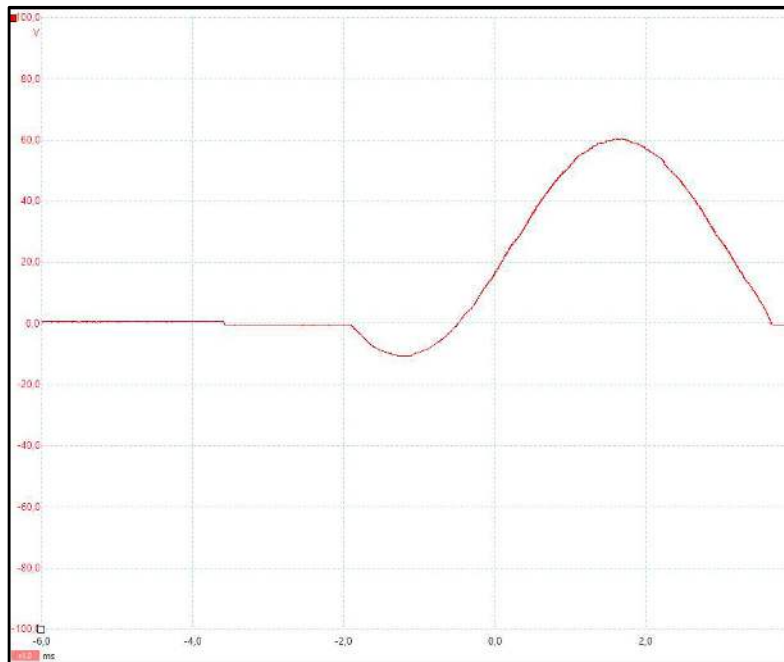

Figure 29: Sensing algorithm: differential voltage across the actuator

In the following capture, the voltage was scaled down to a few volts and the timescale increased so it is possible to see the increase in voltage caused by the force applied on the piezo actuator. We can see where the various parameters of the algorithm apply. Here is an example with 1.3 V threshold and 10 ms hold time:

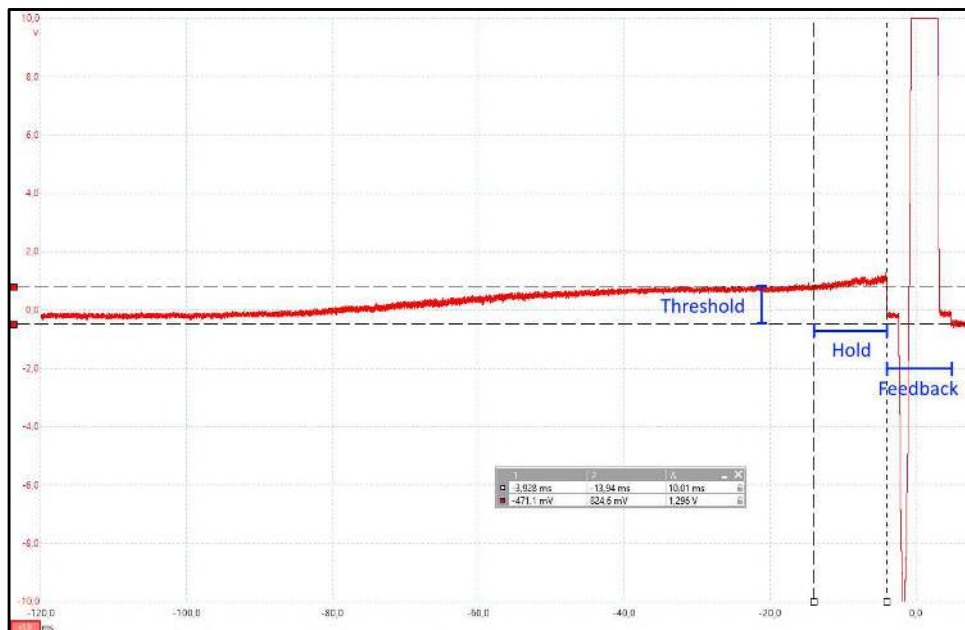

Figure 30: Sensing algorithm: threshold, hold time and feedback.

After the feedback, there is a stabilization phase. In constant stabilization, the output of the BOS1901 is maintained at a fixed voltage for a period of time. In sine stabilization, the output of the BOS1901 follows a sine shaped waveform of a certain amplitude for the stabilization time. Here are some examples:

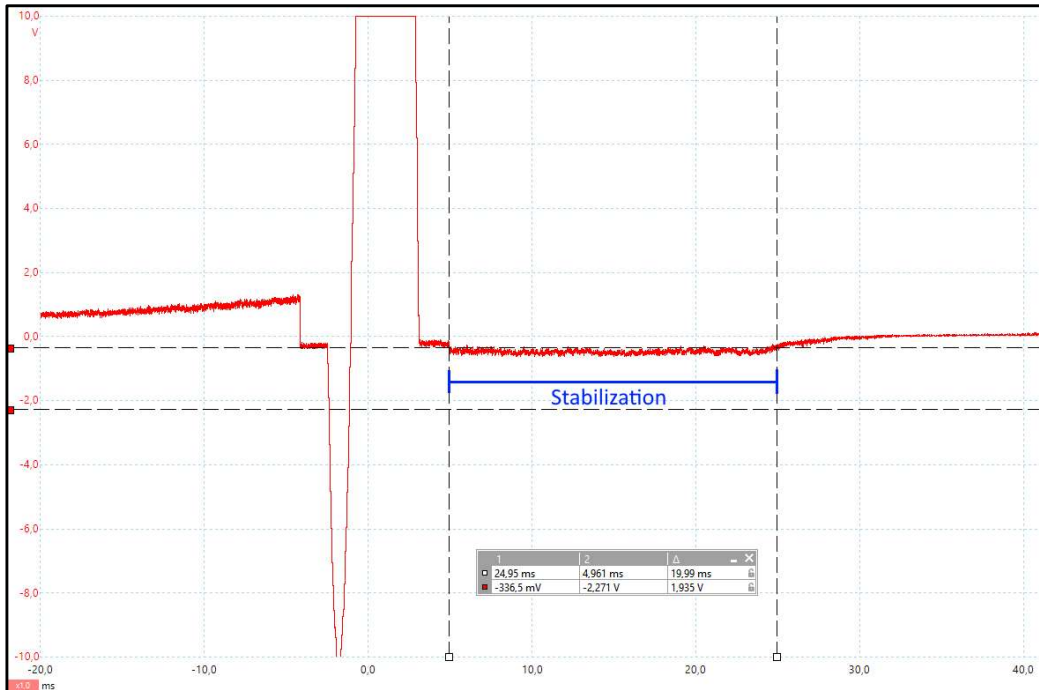

Figure 31: Sensing algorithm: constant stabilization (20 ms, -100 mV)

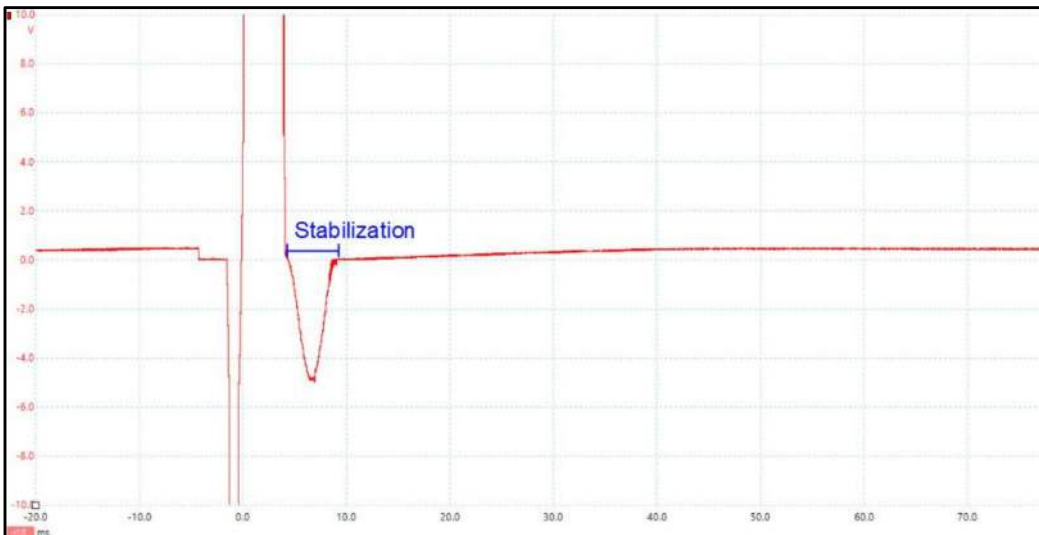

Figure 32: Sensing algorithm: sine stabilization (5 ms, -5 V)



## Appendix B. Firmware Upgrade using STM32CubeProgrammer

The BOS1901-KIT board supports a standard USB endpoint named "Device firmware upgrade" (DFU). This endpoint is used to transfer firmware to the development kit using the USB port and a DFU transfer software. To advertise the DFU endpoint on the USB port, the BOS1901-KIT board microcontroller needs to execute DFU application in the system memory. The boot selection switch allows to select the system memory.

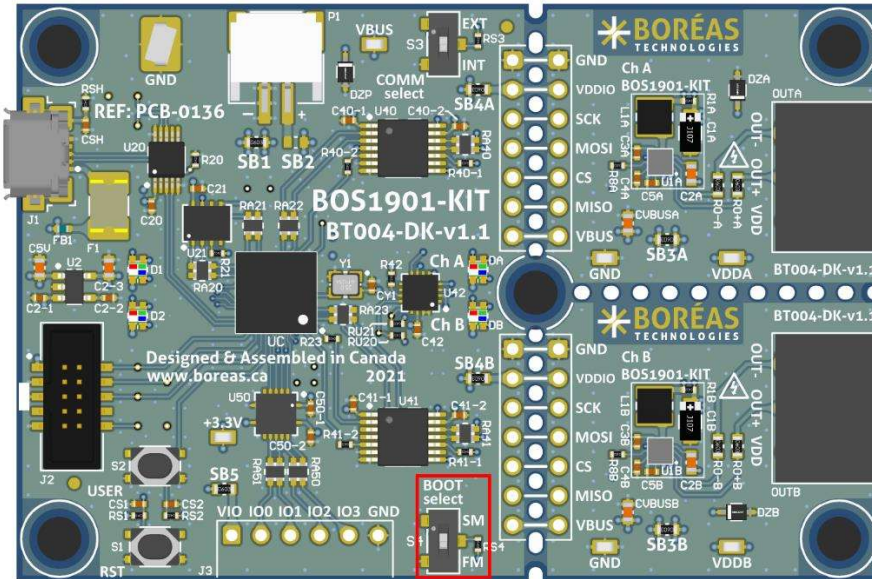

Figure 33 : Boot selection switch position

### Prerequisites

1. Download STM32CubeProgramme using this [link](#) and follow web page instruction.
2. Install STM32CubeProgrammer.
3. Move the Boot Select switch in System Memory (SM) position.
4. Connect the BOS1901-KIT board to a PC using a USB cable.
5. Start SMT32CubeProgrammer.
6. Reset the BOS1901-KIT board using the RST button.
7. Have the appropriate firmware binary file (.hex) handy. The firmware compatible with the Software are located in the installation directory (C:\Program Files (x86)\Boréas Development Kit\firmware). Older firmware revisions can be downloaded on the [Boréas website](#).

## Procedure

1. Select *USB* connection mode in the drop box.
2. Refresh the *Port* list using the button:
3. Select *USB1* port in the *Port* drop box. (Note: If more than one development kit are connected on the same PC the *Port* drop box will contains more than one entry. *USB1* may not be the right device.)
4. Click on *Connect* button.

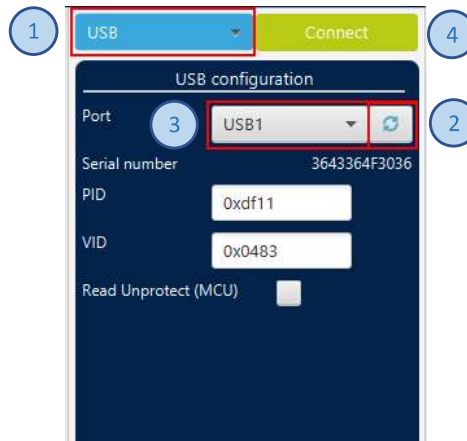

Figure 34: STM32CubeProgrammer connection setting

5. Click on this icon on the left side of the interface to open the *Erase & Programming* panel.
6. Enter the path to the firmware file (.hex) into the *File Path* text field.
7. Check the *Verify programming* checkbox.
8. Click on *Start Programming* button.

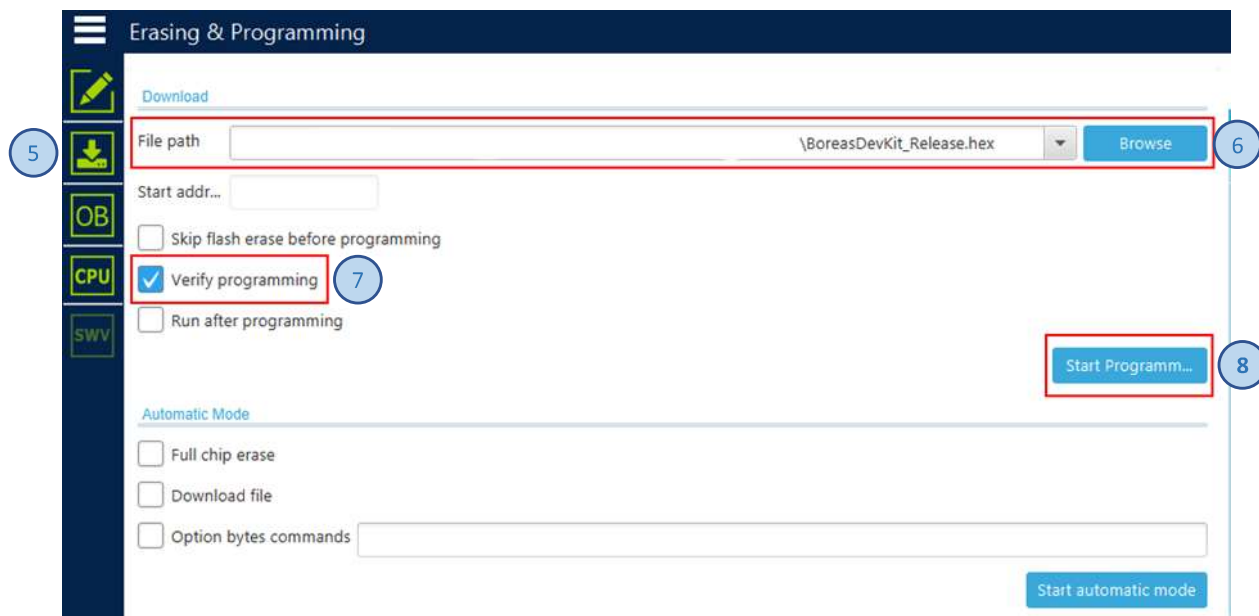
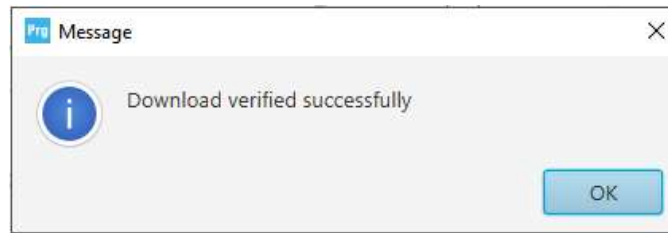

Figure 35: STM32CubeProgrammer programming setting

9. Wait the pop-up message indicating the upgrade completion.



*Figure 36: STM32CubeProgrammer upgrade completed dialog.*

- 10.** Move the Boot Select switch in Flash Memory (FM) position.
- 11.** Reset the development kit using the RST button.

## Appendix C. Audio Mode using Audacity® Software

This appendix explains how Audacity® software can be used to create and play waveforms on the BOS1901-KIT.

### c.1 Software Installation Procedure

Audacity is free of use and can be found at: [link](#)

Please follow the Audacity® installation procedure.

Refer to <https://www.audacityteam.org/about/license/> for the terms of GNU General Public License (GPL) for Audacity® use.

#### dc-offset Plugin Installation (optional)

This plugin will be useful to create waveforms for unipolar piezo actuators or for piezo actuators that have an asymmetrical voltage range (like the TDK piezo supplied with the kit).

1. Download the plugin: [link](#).
2. Install the plugin downloaded using the Nyquist Plug-in Installer.

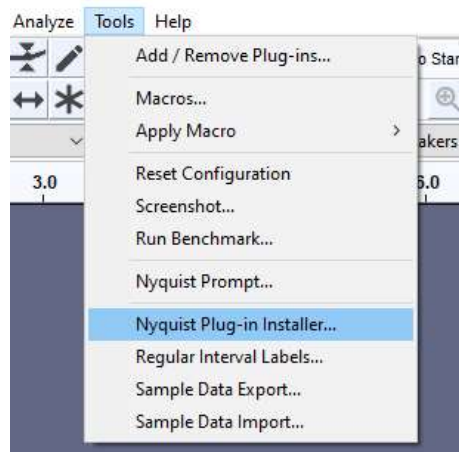

Figure 37: dc-offset plugin installation

3. Ensure the plugin is enabled.

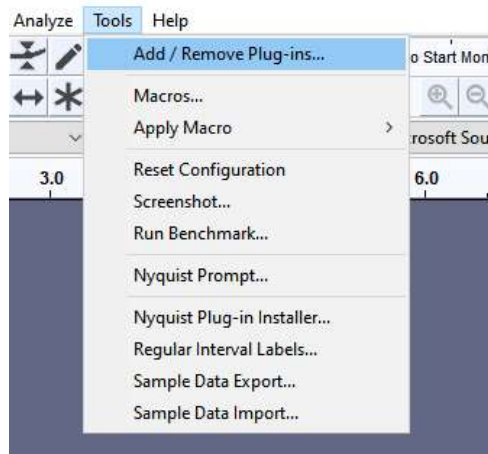

Figure 38: Access plugin management window

- 4. Select dc-offset in the plugin list and click on *Enable* button, then click on *OK*.

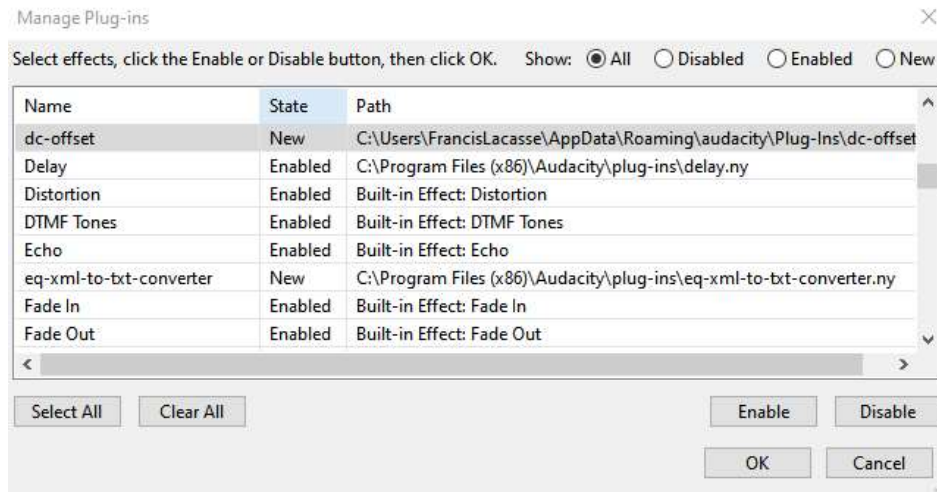

Figure 39: Plugin management window

## C.2 Use Audacity to Play WAV Files

### Description

Download waveform samples from Boréas website and use Audacity® to play them on the BOS1901-KIT.

### Prerequisites

- BOS1901-KIT board is in *Audio* mode. Refer to section 8.5.2 for more information regarding *Audio* mode.
- Using the BOS1901-KIT software, user has configured the audio limiting settings of the board (see details [here](#))
- Download the waveform examples from the Boréas web site ([link](#))

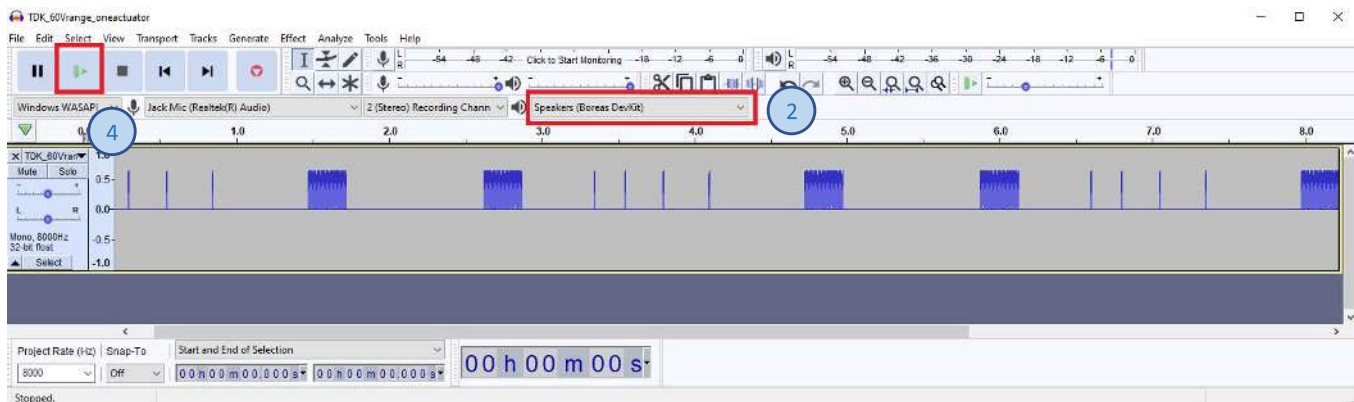

Figure 40: Use audacity to play a WAV file

### Steps

1. Start Audacity software.
2. Select the Speakers (Boreas DevKit) from the playback device selection menu.  
If the Boreas DevKit is not shown in the list, validate that the device kit is in audio mode and that it is connected to the PC. Then from the Audacity menu, click on *Transport / Rescan Audio Devices*.
3. Drag the desired WAV file (Ex: TDK\_60Vrange\_oneactuator.wav) into Audacity to add a new audio track.
4. Press the play button to start playing the waveform on the piezo actuator.

### C.3 Use Audacity and dc-offset Plugin to Create a New Waveform.

#### Description

In this example, we explain how Audacity can be used to create a new sinusoidal waveform in the range of the TDK piezo supplied with the kit (-10 V to 60 V).

In this example the waveform parameters are:

- Amplitude peak to peak = Piezo Vmax – Piezo Vmin = 60 – (-10) = 70 V
- Frequency = 125 Hz
- Duration = 10 sec

#### Prerequisites

- BOS1901-KIT board is in audio mode. Refer to section 8.5.2 for more information regarding *Audio* mode.
- The audio limiting settings of the board are properly configured (Details section 8.5.2.2)
- Audacity and the dc-offset plugin are installed.

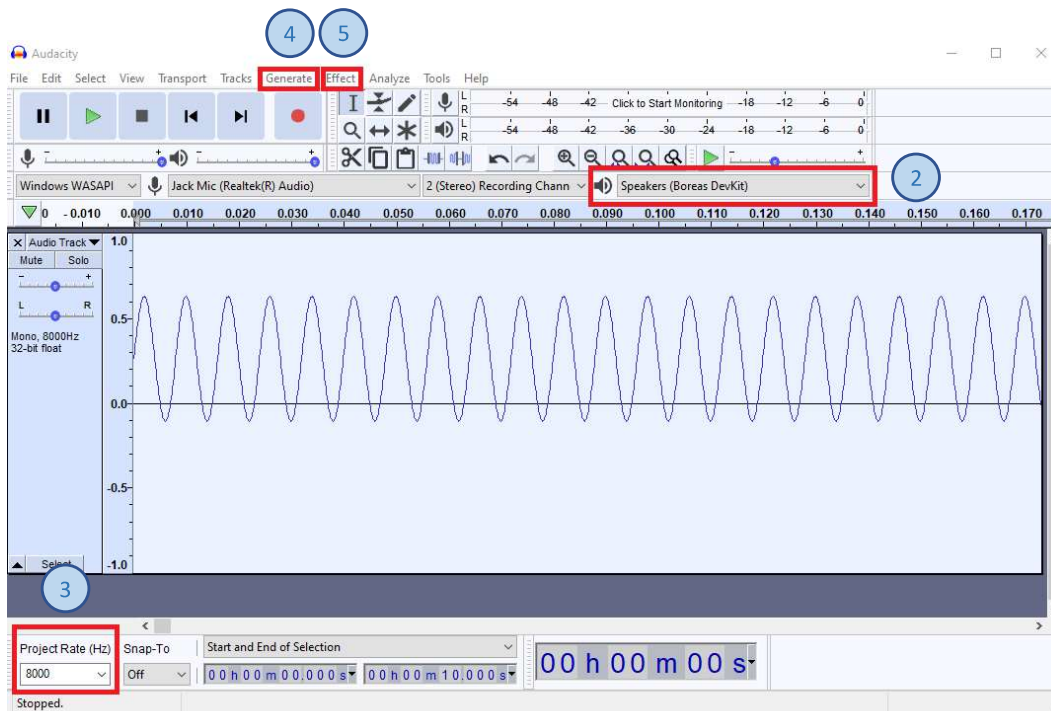

Figure 41: Audacity – simple waveform creation

#### Steps

1. Open Audacity.
2. Select the Speakers (Boreas DevKit) from the playback device selection menu.
3. In the bottom left corner of Audacity, set the project rate to 8000 Hz.
4. In the application menu, select the Option “Generate / Tone”.

To create the waveform with the parameters mentioned in the description, use the following tone values:

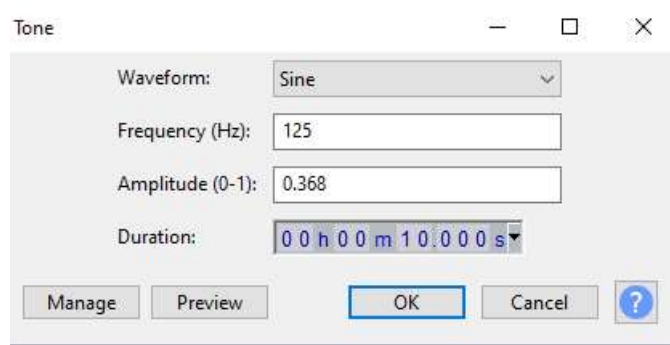

Figure 42: Tone parameters

The amplitude value is calculated with the following formula:

$$\text{Amplitude} = \frac{\text{Peak to Peak Amplitude}}{\text{Boreas IC amplitude max}} \Rightarrow \frac{(60\text{ V} - (-10\text{ V}))}{190\text{ V}} \Rightarrow 0.368$$

5. Use dc-offset plugin to offset the signal in the piezo range:

Offset computation:

$$\frac{\text{Piezo Vmax} + \text{Piezo Vmin}}{\text{Boreas IC amplitude max}} \Rightarrow \frac{60\text{ V} + (-10\text{ V})}{190\text{ V}} \Rightarrow 0.263$$

From the application menu, select *Effect / DC offset...* and enter the value calculated above.

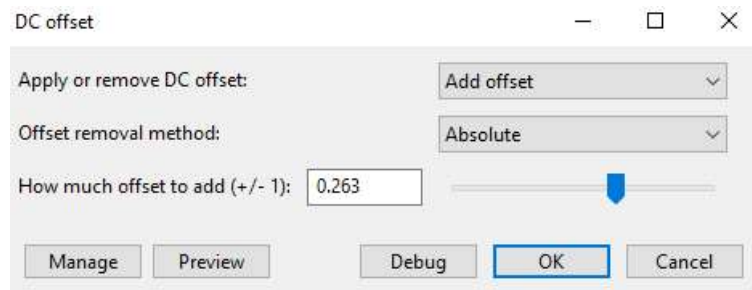

Figure 43: Add dc-offset

6. Play the wave using the play button.



Information relating to products and circuits furnished herein by Boréas Technologies Inc. is believed to be reliable. However, Boréas Technologies assumes no liability for errors that may appear in this document, or for liability otherwise arising from the application or use of any such information which may result from such application or use. The products, their specifications and the information appearing in the document are subject to change by Boréas Technologies without notice. Boréas Technologies products must not be used in life-critical medical equipment, where failure of such equipment would cause serious bodily injury or death, unless both parties have executed an agreement specifically governing such use. Trademarks and registered trademarks are the property of their respective owners.

Design Kits, or modules (Mockup), including software, and specifications are intended for developers in a research and development to evaluate standard Boréas products. Design Kits, or modules (Mockup) are not finished products and shall not be used for finished product. Design Kits, or modules (Mockup) may not be sold for commercial purposes by users, in whole or in part, or used in any finished product or production.

<https://www.boreas.ca/pages/general-terms-and-conditions>

<https://www.boreas.ca/pages/specific-terms-for-the-development-kit>