

0.3 V Ultra-low Output Voltage 100 mA Buck DC/DC Module

NO.EA-640-221031

OVERVIEW

The RM516L is a CMOS-based low-voltage step-down DC/DC module that achieves high efficiency by ultra-low quiescent current ($I_Q = 0.3 \mu\text{A}$) and VFM (maximum switching frequency of 1 MHz) control. Since the RM516L has a built-in inductor and the package is 3.0 (mm) x 2.4 (mm) x 0.8 (mm), QFN2430-8, it is suitable for high density mounting on board.

KEY BENEFITS

- A built-in thin inductor simplifies the board design and dedicates to miniaturize the system.
- An ultra-low quiescent current ($I_Q = 0.3 \mu\text{A}$) and high efficiency at all output current range.
- Low output voltage range (0.3 V to 1.2 V) contributes to low power drive of the system.
- Due to a built-in inductor, the number of external components can be reduced, and the purchasing risk such as EOL can be reduced.

KEY SPECIFICATIONS

- Output current: 100 mA
- Output Voltage Range: 0.1V increments from 0.3 V to 1.2 V
- Output Voltage Accuracy: $\pm 18 \text{ mV}$
- Built-in MOSFET On-resistance ($V_{IN} = 3.6 \text{ V}$): PMOS Typ. 0.19Ω , NMOS Typ. 0.19Ω
- Standby Current: $0.01 \mu\text{A}$

TYPICAL APPLICATIONS

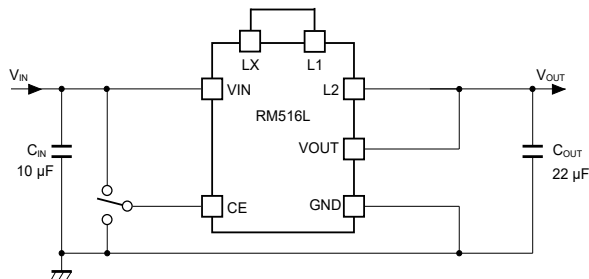

PACKAGE (unit: mm)

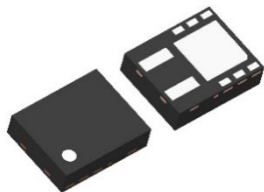

QFN2430-8
3.0 x 2.4 x 0.8

APPLICATIONS

- Wearable equipment such as Smart Watch, Smart Band and Health monitoring
- Li-ion battery-used equipment, Coin cell-used equipment
- Low power RF such as Bluetooth® Low Energy, Zigbee, Wi-SUN and ANT
- Low power CPU, Memory, Sensor device and Energy harvester

TYPICAL PERFORMANCE CHARACTERISTICS

RM516L051x, $T_a = 25^\circ\text{C}$

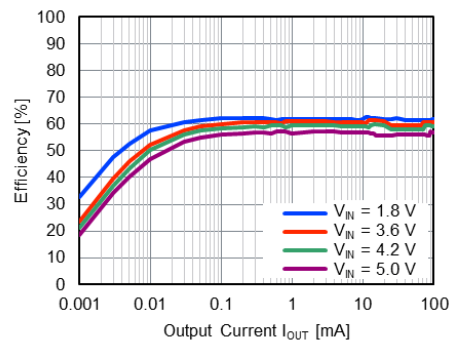

SELECTION GUIDE

Product Name	Package	Quantity per Reel
RM516Lxx1\$-E2	QFN2430-8	3,000 pcs

xx: The set output voltage (V_{SET})

Fixed Output Voltage Type: (0.1V increments from 0.3 V (03) to 1.2 V (12))

\$: The auto-discharge option

Version	Auto-discharge Function	V_{SET}
A	No	0.3 V to 1.2 V
B	Yes	

SELECTION GUIDE

The set output voltage, the auto-discharge function⁽¹⁾ and the packages are user-selectable options.

Selection Guide

Product Name	Package	Quantity per Reel	Pb Free	Halogen Free
RM516Lxx1\$-E2	QFN2430-8	3,000 pcs	Yes	Yes

xx: Specify the set output voltage (V_{SET})

Fixed Output Voltage Type ⁽²⁾: 0.1V increments from 0.3 V (03) to 1.2 V (12)

\$: Select the auto-discharge option

Version	Auto-discharge Function	V_{SET}
A	No	0.3 V to 1.2 V
B	Yes	

⁽¹⁾ Auto-discharge function quickly lowers the output voltage to near 0 V by discharging the charge stored in the output capacitor, when the chip enable signal is switched from the active mode to the standby mode.

⁽²⁾ The custom specification of 0.05 V step is available.

BLOCK DIAGRAMS

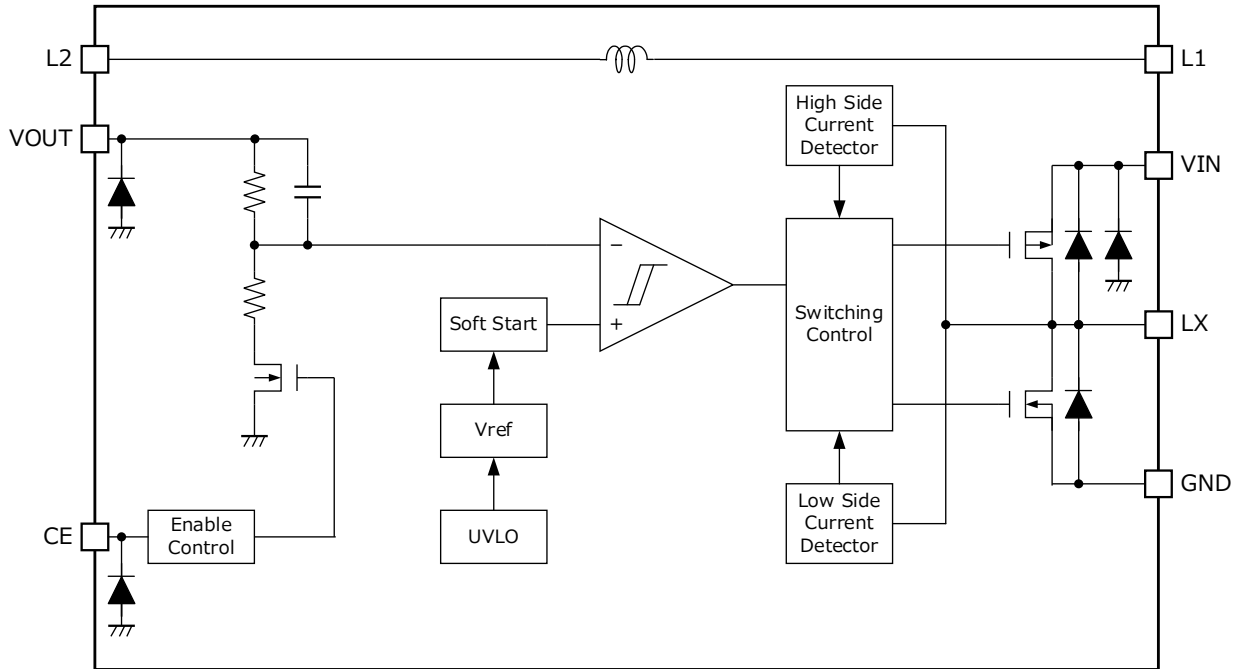

RM516Lxx1A Block Diagram

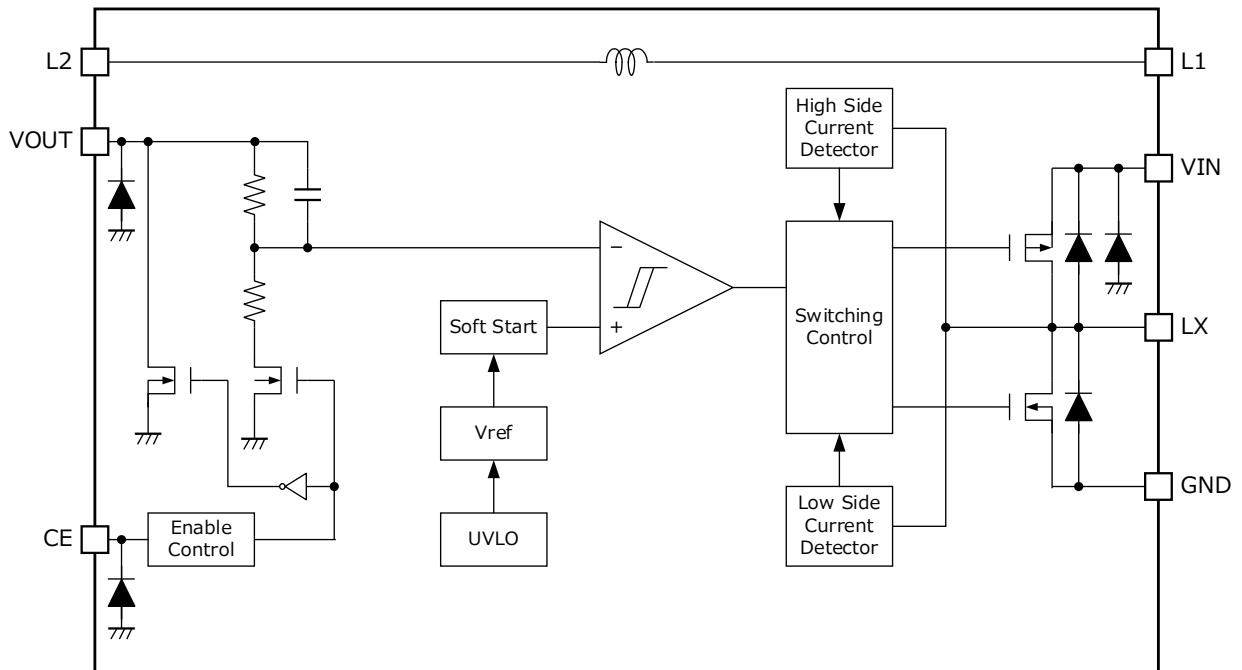

RM516Lxx1B Block Diagram

PIN DESCRIPTION

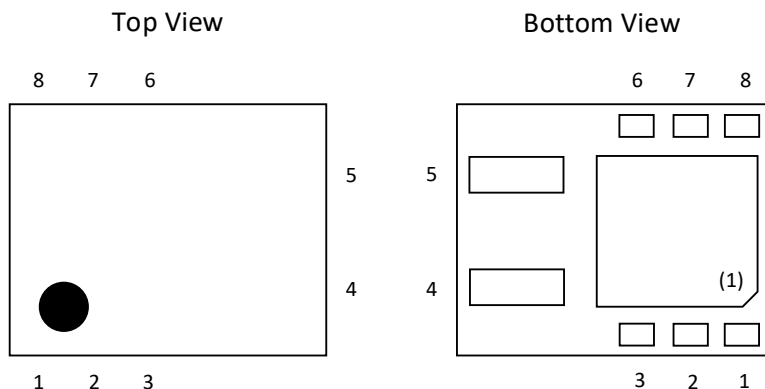

RM516L Pin Configuration

RM516L Pin Descriptions

Pin No.	Symbol	Description
1	GND	Ground Pin
2	GND	Ground Pin
3	LX	Switching Output Pin (Internal MOSFET Drain) Connect this pin the L1 pin on the board.
4	L1	Inductor Pin 1 (Input pin of inductor built-in.) Connect this pin to Lx pin.
5	L2	Inductor Pin 2 (This pin connects to built-in inductor) Connect a capacitor between this pin and GND.
6	VOUT	Output voltage feedback pin Connect this pin to L2 pin.
7	VIN	Power Supply Input Pin Connect the capacitor between this pin and GND.
8	CE	Chip Enable Pin (Active-high) Forcing this pin "High" enables the operation of RM516L Forcing this pin "Low" disables the operation of RM516L (standby state)

⁽¹⁾ The tab on the bottom of the package enhances thermal performance and is electrically connected to GND (substrate level). It is recommended that the tab be connected to the ground plane on the board.

ABSOLUTE MAXIMUM RATINGS

Absolute Maximum Ratings

(GND = 0 V)

Symbol	Parameter	Rating	Unit
V_{IN}	Input Pin Voltage	-0.3 to 6.5	V
$V_{LX}/V_{L1}/V_{L2}$	LX/L1/L2 Pin Voltage	-0.3 to $V_{IN} + 0.3$	V
V_{CE}	CE Pin Voltage	-0.3 to 6.5	V
V_{OUT}	VOUT Pin Voltage	-0.3 to 6.5	V
P_D	Power Dissipation ⁽¹⁾ QFN2430-8, JEDEC STD. 51	2000	mW
T_j	Junction Temperature Range	-40 to 125	°C
T_{stg}	Storage Temperature Range	-55 to 125	°C

ABSOLUTE MAXIMUM RATINGS

Electronic and mechanical stress momentarily exceeded absolute maximum ratings may cause permanent damage and may degrade the lifetime and safety for both device and system using the device in the field. The functional operation at or over these absolute maximum ratings is not assured.

RECOMMENDED OPERATING CONDITIONS

Recommended Operating Conditions

Symbol	Parameter	Rating	Unit
V_{IN}	Input Voltage	1.8 to 5.5	V
T_a	Operating Temperature Range	-40 to 85	°C

RECOMMENDED OPERATING CONDITIONS

All of electronic equipment should be designed that the mounted semiconductor devices operate within the recommended operating conditions. The semiconductor devices cannot operate normally over the recommended operating conditions, even if they are used over such conditions by momentary electronic noise or surge. And the semiconductor devices may receive serious damage when they continue to operate over the recommended operating conditions.

⁽¹⁾ Refer to *POWER DISSIPATION* for detailed information.

ELECTRICAL CHARACTERISTICS

The specifications surrounded by are guaranteed by design engineering at $-40^{\circ}\text{C} \leq T_a \leq 85^{\circ}\text{C}$.

RM516L Electrical Characteristics

($T_a = 25^{\circ}\text{C}$)

Symbol	Parameter	Parameter	Min.	Typ.	Max.	Unit
V_{OUT}	Output Voltage	$V_{\text{IN}} = V_{\text{CE}} = 3.6 \text{ V}$	-0.018		+0.018	V
I_{Q}	Operating Quiescent Current	$V_{\text{IN}} = V_{\text{CE}} = V_{\text{OUT}} = 5.5 \text{ V}$, No-switching time		0.3		μA
I_{STANDBY}	Standby Current	$V_{\text{IN}} = 5.5 \text{ V}$, $V_{\text{CE}} = 0 \text{ V}$		0.01	0.5	μA
I_{CEH}	CE Pin Input Current, high	$V_{\text{IN}} = V_{\text{CE}} = 5.5 \text{ V}$	-0.025	0	0.025	μA
I_{CEL}	CE Pin Input Current, low	$V_{\text{IN}} = 5.5 \text{ V}$, $V_{\text{CE}} = 0 \text{ V}$	-0.025	0	0.025	μA
I_{VOUTH}	VOUT pin input current, high	$V_{\text{IN}} = V_{\text{OUT}} = 5.5 \text{ V}$, $V_{\text{CE}} = 0 \text{ V}$	-0.025	0	0.025	μA
I_{VOUTL}	VOUT pin input current, low	$V_{\text{IN}} = 5.5 \text{ V}$, $V_{\text{CE}} = V_{\text{OUT}} = 0 \text{ V}$	-0.025	0	0.025	μA
R_{DISN}	Auto-discharge NMOSFET On-state Resistance ⁽¹⁾	$V_{\text{IN}} = 3.6 \text{ V}$, $V_{\text{CE}} = 0 \text{ V}$		60		Ω
V_{CEH}	CE Pin Input Voltage, high	$1.8 \text{ V} \leq V_{\text{IN}} \leq 5.5 \text{ V}$	1.0			V
V_{CEL}	CE Pin Input Voltage, low	$1.8 \text{ V} \leq V_{\text{IN}} \leq 5.5 \text{ V}$			0.4	V
R_{ONP}	PMOSFET on-resistance	$V_{\text{IN}} = 3.6 \text{ V}$, $I_{\text{LX}} = -100 \text{ mA}$		0.19		Ω
R_{ONN}	NMOSFET on-resistance	$V_{\text{IN}} = 3.6 \text{ V}$, $I_{\text{LX}} = -100 \text{ mA}$		0.19		Ω
t_{START}	Soft-start time	$V_{\text{IN}} = V_{\text{CE}} = 3.6 \text{ V}$		10		ms
I_{LXLIM}	LX current limit	$V_{\text{IN}} = V_{\text{CE}} = 3.6 \text{ V}$	210	430		mA
V_{UVLOF}	Undervoltage lockout (UVLO) threshold voltage	$V_{\text{IN}} = V_{\text{CE}}$, falling	1.40	1.50	1.65	V
V_{UVLOR}		$V_{\text{IN}} = V_{\text{CE}}$, rising	1.55	1.65	1.80	V

All test items listed under Electrical Characteristics are done under the pulse load condition ($T_j \approx T_a = 25^{\circ}\text{C}$). Test circuit is operated with "Open Loop Control" ($\text{GND} = 0 \text{ V}$), unless otherwise specified.

⁽¹⁾ RM516Lxx1B only

Product-specific Electrical Characteristics

Product name	V_{OUT} [V]		
	Min.	Typ.	Max.
RM516L031x	0.282	0.30	0.318
RM516L041x	0.382	0.40	0.418
RM516L051x	0.482	0.50	0.518
RM516L061x	0.582	0.60	0.618
RM516L071x	0.682	0.70	0.718
RM516L081x	0.782	0.80	0.818
RM516L091x	0.882	0.90	0.918
RM516L101x	0.982	1.00	1.018
RM516L111x	1.082	1.10	1.118
RM516L121x	1.182	1.20	1.218

TYPICAL APPLICATION CIRCUIT

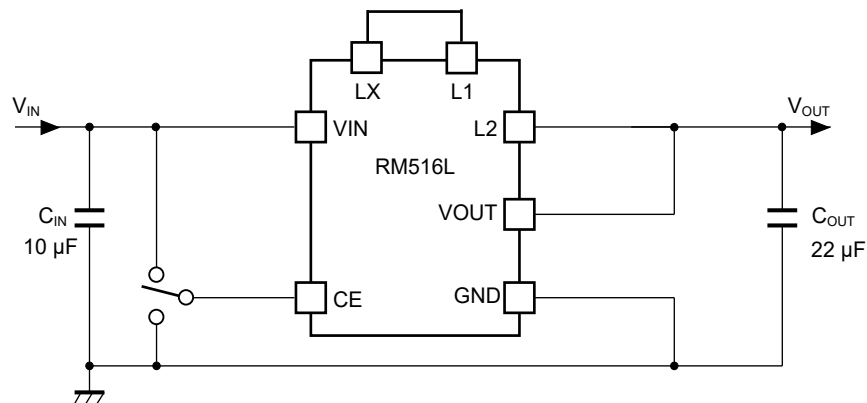

RM516L Typical Application Circuit

Precautions for Selecting External Components

- Choose a low ESR ceramic capacitor. The input capacitor (C_{IN}) between VIN and GND should be more than 10 μF , and the output capacitor (C_{OUT}) should be used of 22 μF . Also, choose the capacitor with consideration for bias characteristics and input/output voltages. Even when using a capacitor other than a ceramic capacitor such as aluminum electrolytic, connect a ceramic capacitor with shortest-distance wiring.

TECHNICAL NOTES

The performance of a power source circuit using this device is highly dependent on the peripheral circuit. A peripheral component or the device mounted on PCB should not exceed a rated voltage, a rated current or a rated power. When designing a peripheral circuit, please be fully aware of the following points.

- When an intermediate voltage other than V_{IN} and GND is input to the CE pin, a supply current may be increased by a through current of a logic circuit in the IC. The CE pin is neither pulled up nor pulled down, therefore the operation is not stable at open.
- Behavior below 1.8V (Minimum recommended operating voltage)
When operating below 1.8V (the minimum recommended operating voltage), the output voltage may become unstable and exceed the set output voltage. To avoid this behavior, when starting up the RM516L with tied VIN pin and CE pin, the ramp up slew rate of the input voltage should be 5 [V/ms] or more. If VIN pin's ramp up slew rate is 5 [V/ms] or less, CE pin should be active after the VIN power supply voltage exceeds 1.8V. To avoid the unstable behavior at power down, when turning off the RM516L with tied VIN pin and CE pin, the power down slew rate should be faster than -5 [V/ms]. If VIN pin's power down slew rate is slower than -5 [V/ms], the CE pin must be low before the power supply voltage drops below 1.65V.
- Output ripple voltage
Output ripple voltage may be large when V_{IN} voltage is high. In such a case, by using a ceramic capacitor, $C_{OUT} = 44 \mu\text{F}$ or more, output ripple voltage will be small. When using an electrolytic capacitor for the output line, place a ceramic capacitor with the closest point to the IC, and place the electrolytic capacitor at the second closest point.
- The tab on the bottom side of the package is recommended to be connected to GND or just solder to The board according to the recommended land pattern. If it is open, the heat dissipation and mounting strength will be worse.

THEORY OF OPERATION

Enable Function

Forcing above designated "High" voltage to CE pin, the RM516L becomes active. Forcing below designated "Low" voltage to CE pin shuts down the RM516L. In standby condition, all functions are disabled except auto discharge function. With auto discharge option, the MOSFET to discharge the output capacitor turns on and the output is pulled down to GND. Without auto discharge option, the output becomes "Hi-Z". CE pin can accept input range voltage regardless of the input of VIN pin.

Do not open the CE pin because it is not pulled up or down inside the IC.

If Enable function is not necessary, tie CE pin to VIN pin or other designated "High" voltage node at start-up.

Soft-start Time

Starting-up with CE Pin

The IC starts to operate when the CE pin voltage (V_{CE}) exceeds the threshold voltage. The threshold voltage is preset between CE "High" input voltage (V_{CEH}) and CE "Low" input voltage (V_{CEL}). After the start-up of the IC, soft-start circuit starts to operate. Then, after a certain period, the reference voltage (V_{REF}) in the IC gradually increases up to the specified value. Switching starts when V_{REF} reaches the preset voltage, and after that the output voltage rises as V_{REF} increases. Soft-start time (t_{START}) indicates the period from the time soft-start circuit gets activated to the time V_{REF} reaches the specified voltage. t_{START} is not always equal to the turn-on speed of the DC/DC converter. Note that the turn-on speed could be affected by the power supply capacity, the output current (I_{OUT}), the output capacitor value (C_{OUT}).

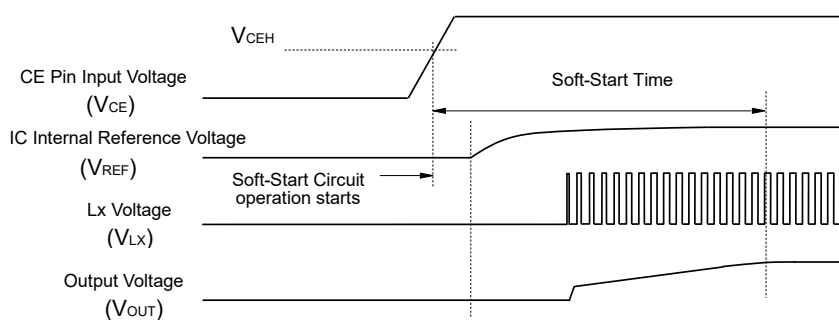

Timing Chart: Starting-up with CE Pin

Starting-up with Power Supply

Please note that the rise of the output voltage (V_{OUT}) at power supply startup is affected by the power supply to the IC and the input capacitor (C_{IN}), the rise speed of the input voltage (V_{IN}), the output capacitor (C_{OUT}), and the output current (I_{OUT}).

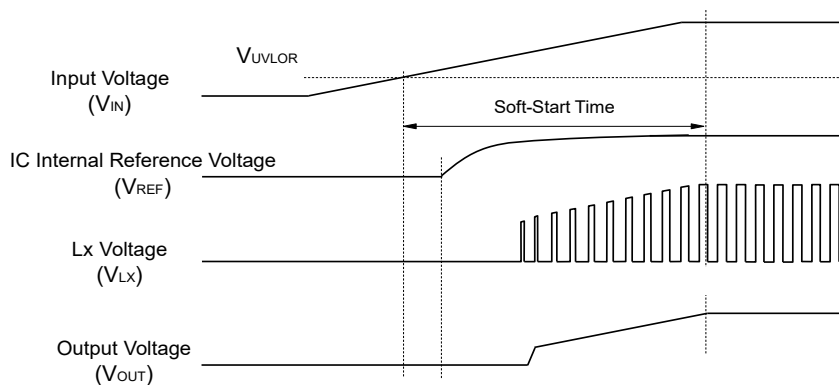

Timing Chart: Starting-up with Power Supply

Undervoltage Lockout (UVLO) Circuit

When the V_{IN} drops below the UVLO detector threshold (V_{UVLOF}), the UVLO operates, V_{REF} stops, and PMOSFET and NMOSFET turn “OFF”.

As a result, V_{OUT} drops according to the C_{OUT} capacitance value and I_{OUT} .As for RM516Lxx1B, the discharge MOSFET for C_{OUT} discharges after it turns on.

To restart the operation, V_{IN} needs to exceed V_{UVLOR} . The timing chart below shows the voltage shifts of V_{REF} , V_{LX} and V_{OUT} when V_{IN} value is varied.

Note: Falling edge (operating) and rising edge (releasing) waveforms of V_{OUT} could be affected by the initial voltage of C_{OUT} and the output current of V_{OUT} .

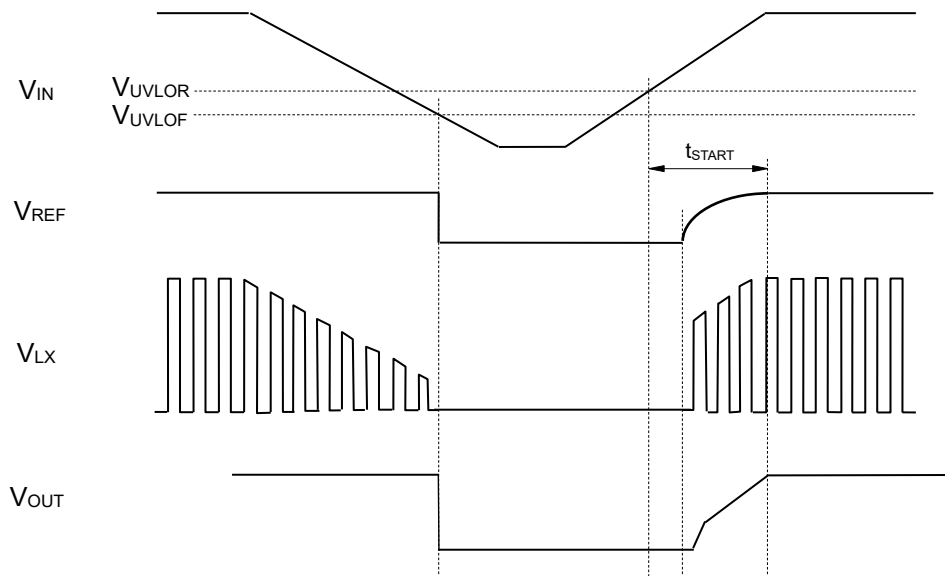

Timing Chart with Variations in Input Voltage (V_{IN})

Auto Discharge Function

When turned off, the V_{OUT} voltage drops rapidly to near 0V by discharging the charge stored in the output capacitor through the MOSFET connected between the VOUT pin and GND pin. The auto discharge function is enabled when the EN pin = "low" and UVLO detection. On-resistance of MOSFET is Typ.60 Ω .

Operation of Buck DC/DC Converter and Output Current

General operation of the buck DC/DC converter is shown in the following figures.

The buck DC/DC converter charges energy in the inductor while High Side MOSFET turns “ON”, and discharges the energy from the inductor when LX transistor turns “OFF”. This inductor reduces the energy loss to provide the lower output voltage (V_{OUT}) than the input voltage (V_{IN}). The operation of the buck DC/DC converter is shown in the following figures.

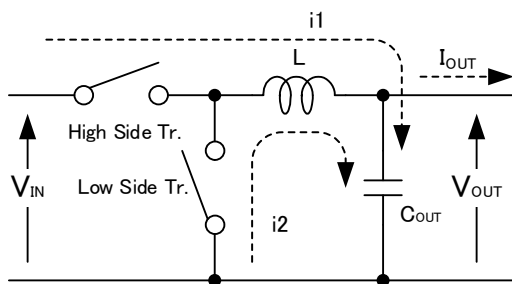

Basic Circuit

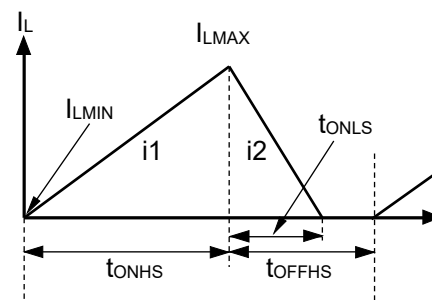

Inductor Current (I_L) flowing through Inductor (L)

- Step1.** When the High Side MOSFET turns “ON”, I_L ($i1$) flows through the inductor to charge C_{OUT} and provide I_{OUT} . At this moment, $i1$ increases from the minimum inductor current (I_{LMIN}) of 0 A to reach the maximum inductor current (I_{LMAX}) in proportion to the on-time period of High Side MOSFET (t_{ONHS}).
- Step2.** When High Side MOSFET turns “OFF”, the inductor turns Low Side MOSFET “ON” to maintain I_L at I_{LMAX} and I_L ($i2$) flows into L.
- Step3.** $I_L = i2$ decreases gradually and reaches I_{LMIN} after the open-time period of Low Side MOSFET and Low Side MOSFET (t_{ONLS}) turns “OFF”. This is called discontinuous current mode.
As to the continuous current mode, the output current (I_{OUT}) increases and the off-time period of High Side MOSFET (t_{OFFHS}) ends before I_L reaches I_{LMIN} . In the next cycle, High Side MOSFET turns “ON” and Low Side MOSFET turns “OFF”, then I_L increases from $I_L = I_{LMIN} > 0$.

When the buck DC/DC operation is constant, I_{LMIN} and I_{LMAX} during the open-time period of Low Side MOSFET (t_{ONHS}) would be same as during the off-time period of High Side MOSFET. The difference of the current between I_{LMAX} and I_{LMIN} represents ΔI as shown in the following equation 1.

$$\Delta I = I_{LMAX} - I_{LMIN} = V_{OUT} \times t_{ONLS} / L = (V_{IN} - V_{OUT}) \times t_{ONHS} / L \dots\dots\dots (1)$$

A switching frequency varies depending on values of input voltage (V_{IN}), output voltage (V_{OUT}), and output current (I_{OUT}). Check the actual characteristics to avoid the switching noise.

A switching starts when V_{OUT} drops below the lower-limit reference voltage (V_{REFL}). When V_{OUT} exceeds the upper-limit reference voltage (V_{REFH}), a constant voltage is output by a hysteresis control which stops the switching.

To operate within the rated characteristic of inductor and avoid the deteriorated band frequency of DC superimposed characteristics, when the inductor current (I_L) exceeds LX current limit (I_{LXLIM}), the operation shifts to off-cycle. And when I_L falls to 0A, the operation shift to on-cycle.

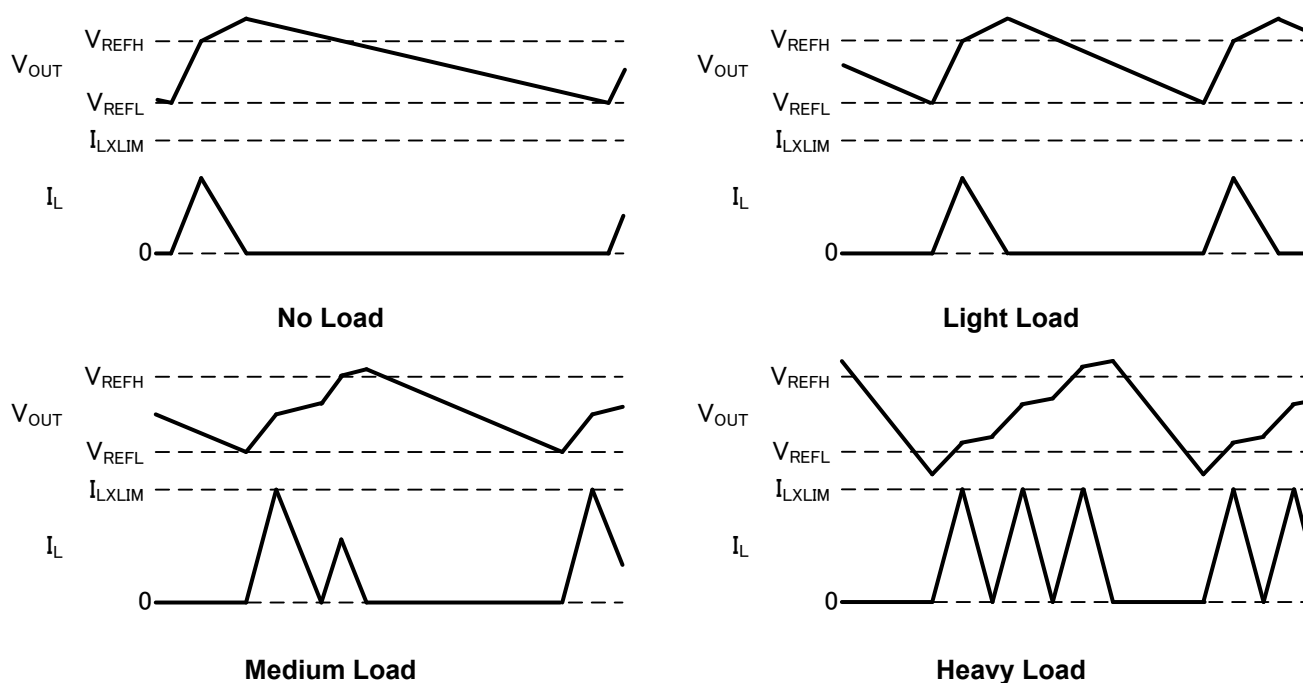

APPLICATION INFORMATION

PCB Layout

RM516Lxx1x (QFN2430-8)

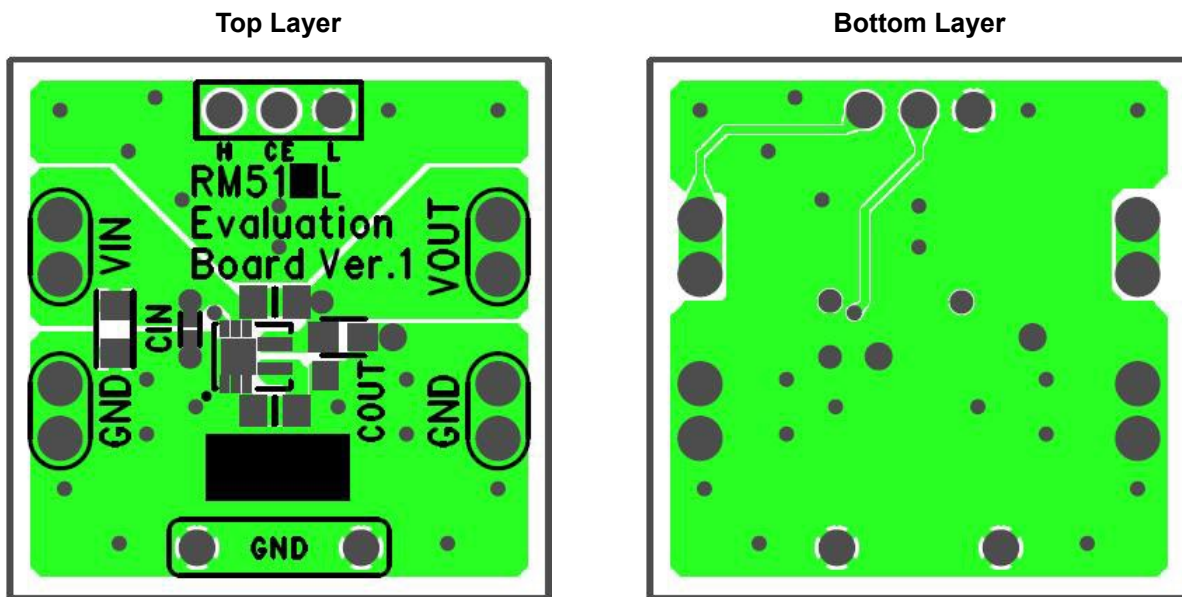

TYPICAL CHARACTERISTICS

Note: Typical Characteristics are intended to be used as reference data; they are not guaranteed.

1) Quiescent Current vs Temperature

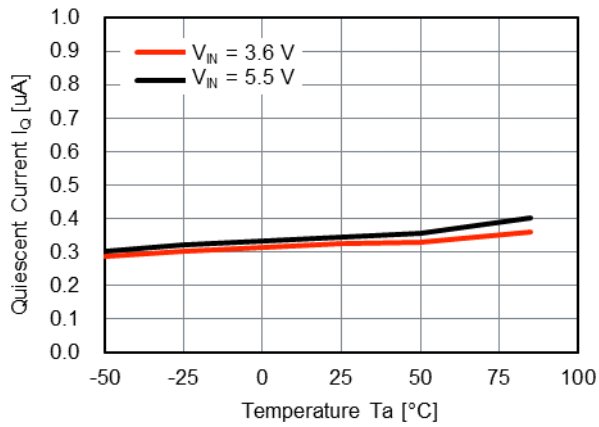

2) Standby Current vs Temperature

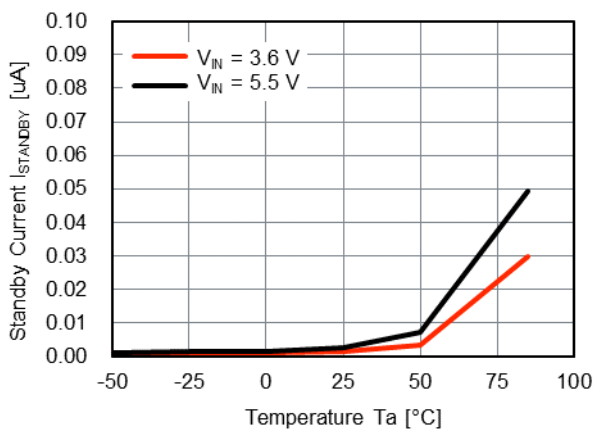

3) Output Voltage vs Temperature

RM516L051x, V_{IN}=3.6 V

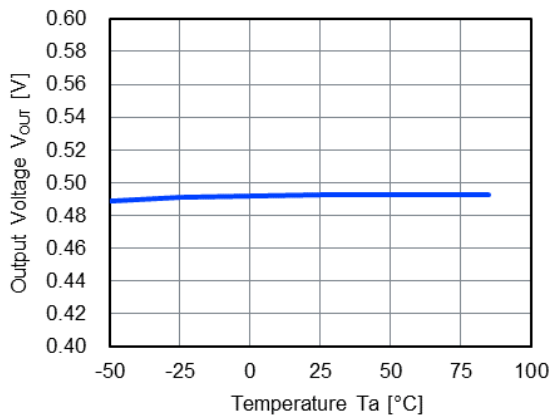

4) Efficiency vs Output Current

RM516L031x, Ta=25°C

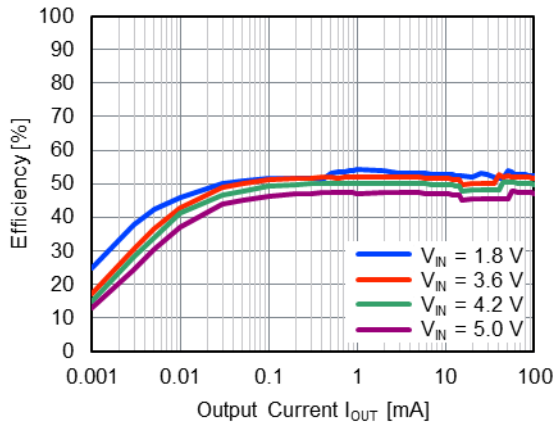

RM516L051x, Ta=25°C

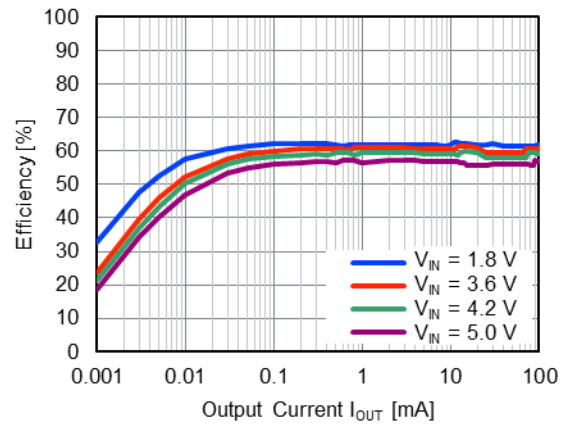

RM516L121x, Ta=25°C

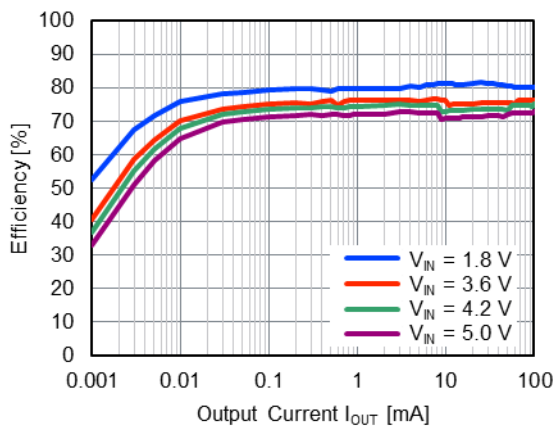

5) Output Voltage vs Output Current

RM516L031x, Ta=25°C

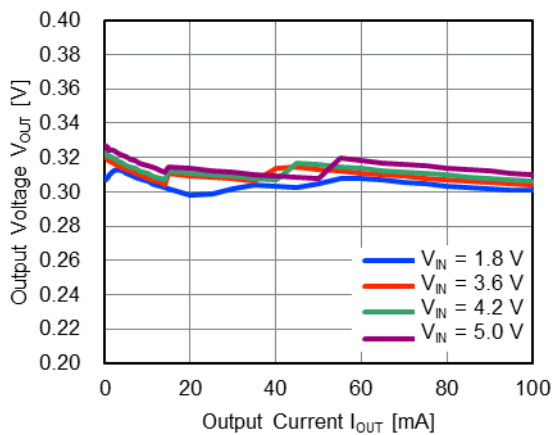

RM516L051x, Ta=25°C

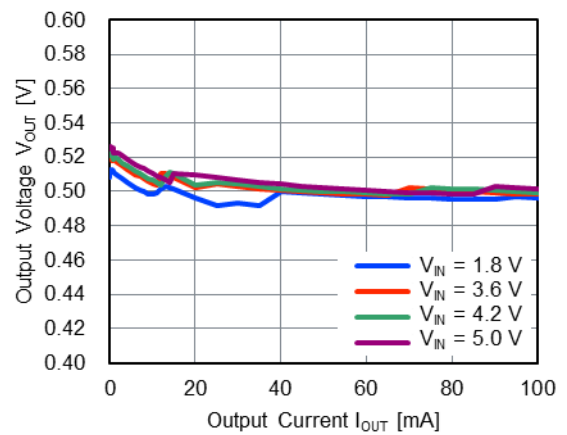

RM516L121x, Ta=25°C

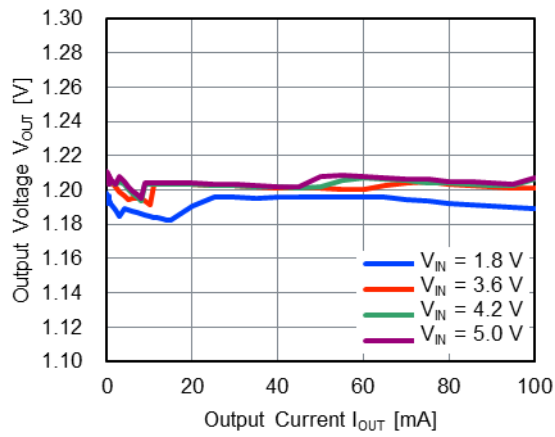

6) Ripple Voltage vs Output Current
RM516L031x, Ta=25°C

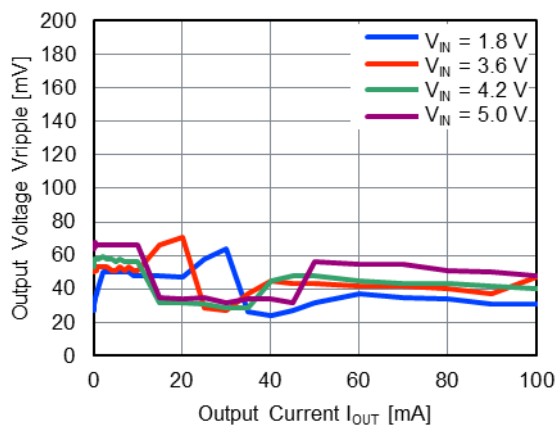

RM516L051x, Ta=25°C

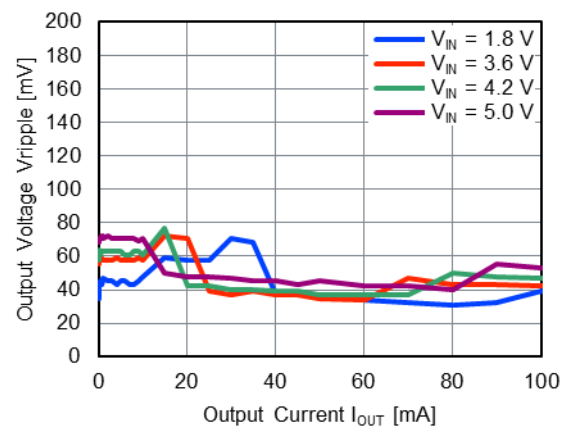

RM516L121x, Ta=25°C

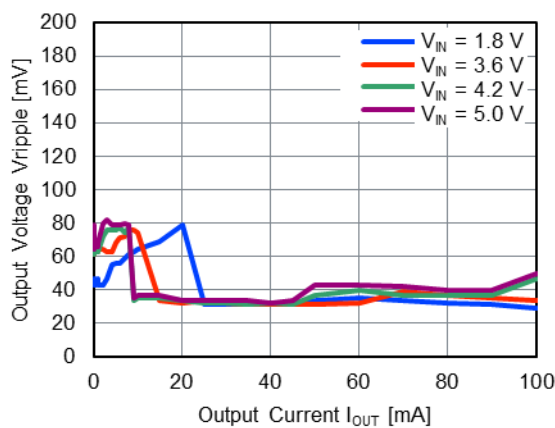

7) Switching Frequency vs Output Current

RM516L031x, Ta=25°C

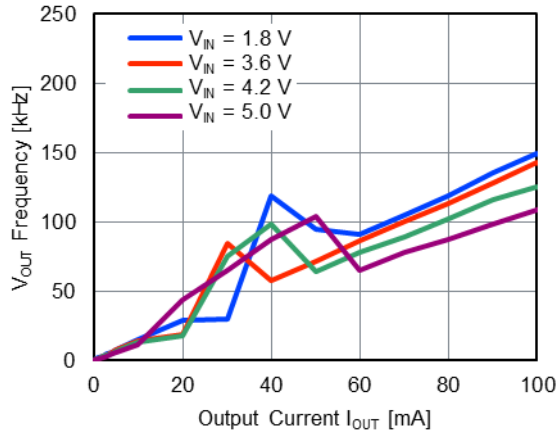

RM516L051x, Ta=25°C

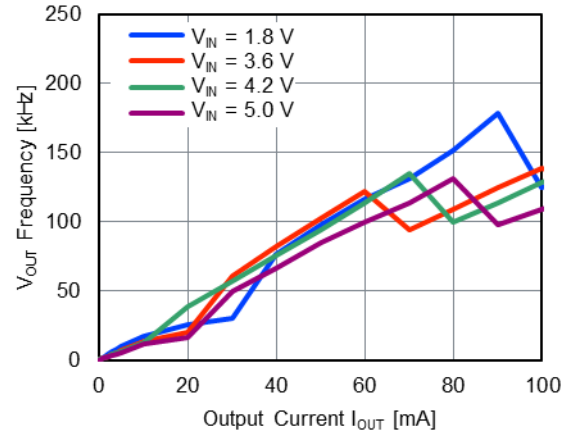

RM516L121x, Ta=25°C

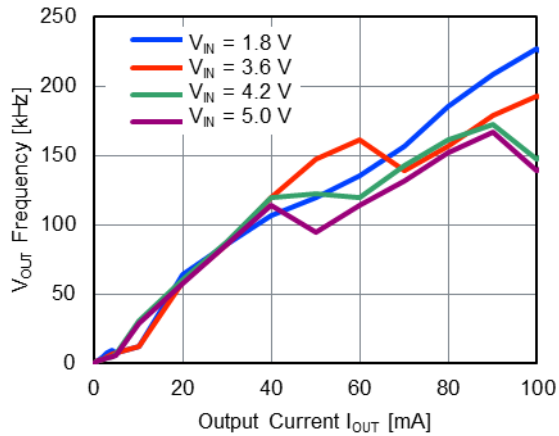

8) Load Transient Response

RM516L051x, VIN=3.6V, Ta=25°C

IOUT= 0.01mA -> 50mA

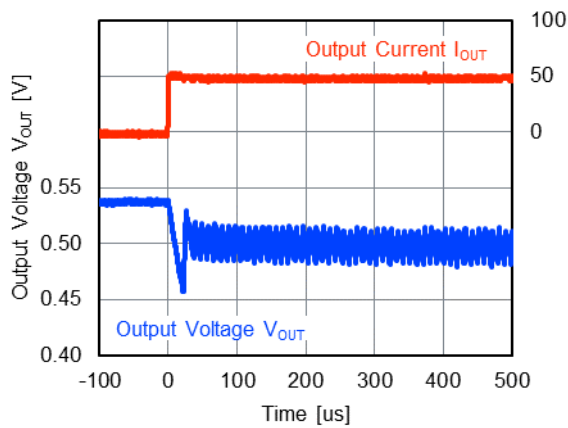

IOUT= 50mA -> 0.01mA

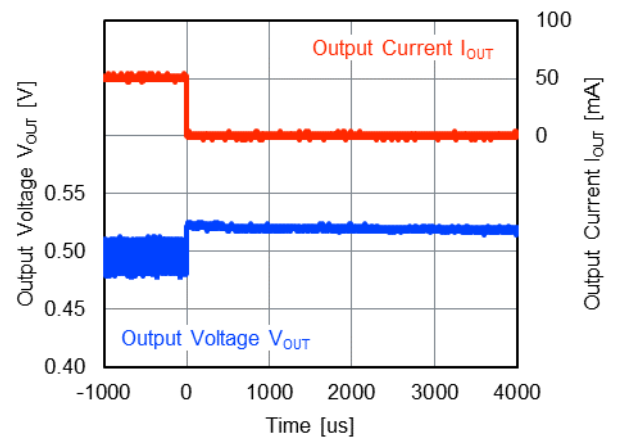

9) Soft Start Time

RM516L051x, $V_{IN}=3.6V$, $V_{CE}=0V \rightarrow 3.6V$, $\Delta t=10\mu s$, $T_a=25^\circ C$

$I_{OUT}=100mA$

$I_{OUT}=0mA$

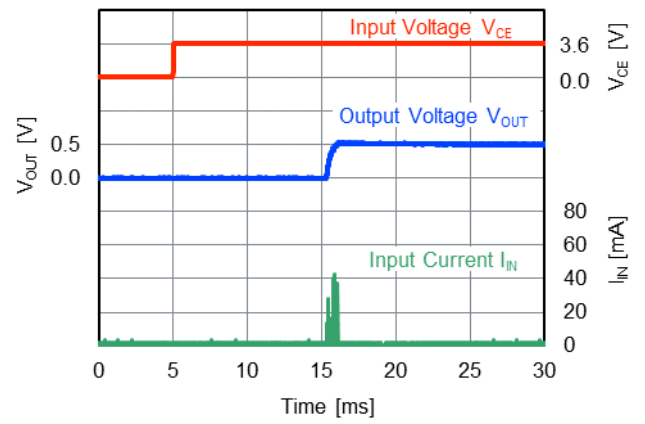
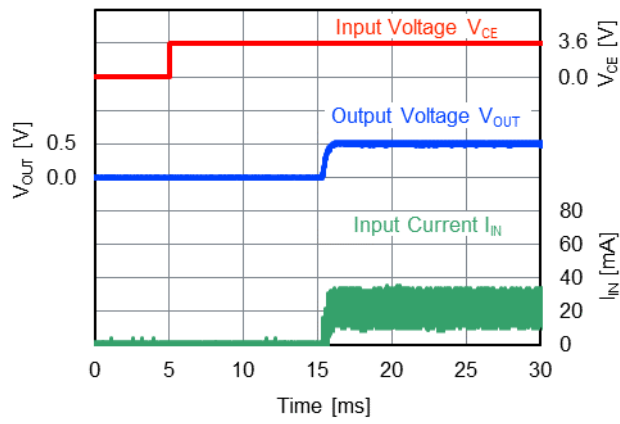

Test Circuit

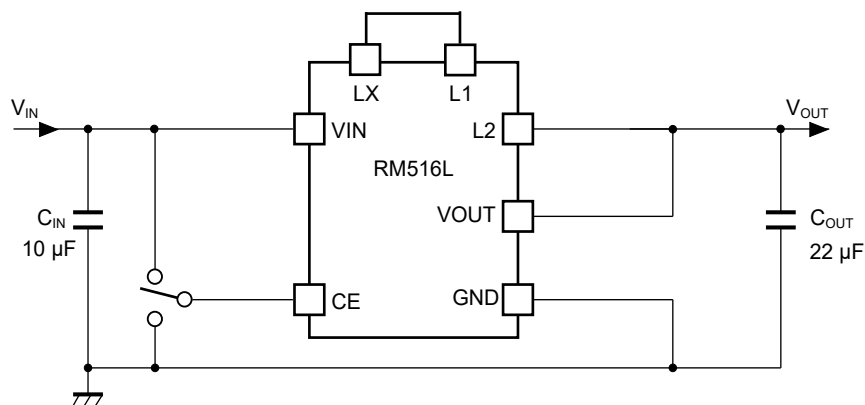

Test Circuit of Typical Characteristics

Measurement Components of Typical Characteristics

Symbol	Capacitance	Manufacture	Parts number
C _{IN}	10μF	Murata	GRM155R60J106ME0
C _{OUT}	22μF	TAIYO YUDEN	JMK107BBJ226MA-T

The power dissipation of the package is dependent on PCB material, layout, and environmental conditions. The following measurement conditions are based on JEDEC STD. 51.

Measurement Conditions

Item	Measurement Conditions
Environment	Mounting on Board (Wind Velocity = 0 m/s)
Board Material	Glass Cloth Epoxy Plastic (Four-Layer Board)
Board Dimensions	76.2 mm × 114.3 mm × 1.6 mm
Copper Ratio	Outer Layer (First and Fourth Layer): More than 95% of 50 mm Square Inner Layers (Second and Third Layers): Approx. 100% of 50 mm Square
Through-holes	φ 0.3 mm × 12 pcs

Measurement Result

(Ta = 25°C, Tjmax = 125°C)

Item	Measurement Result
Power Dissipation	2000 mW
Thermal Resistance (θja)	θja = 50°C/W
Thermal Characterization Parameter (ψjt)	ψjt = 14°C/W

θja: Junction-to-Ambient Thermal Resistance

ψjt: Junction-to-Top Thermal Characterization Parameter

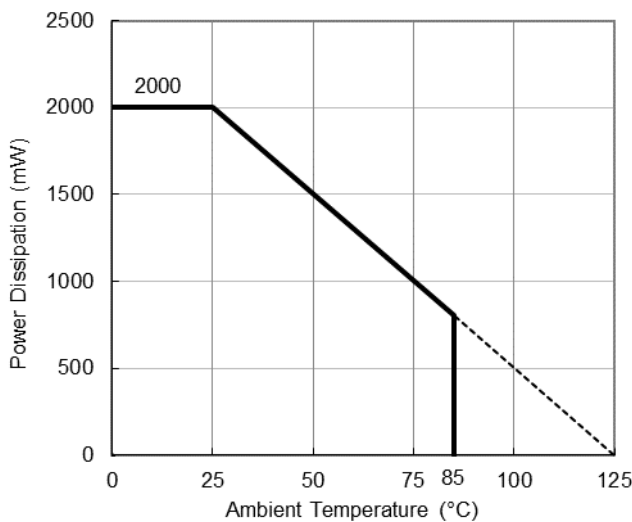

Power Dissipation vs. Ambient Temperature

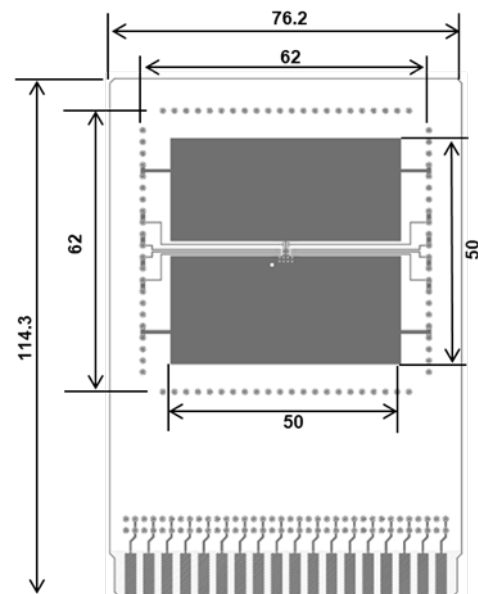

Measurement Board Pattern

PACKAGE DIMENSIONS

QFN2430-8

DM-QFN2430-8-JE-A

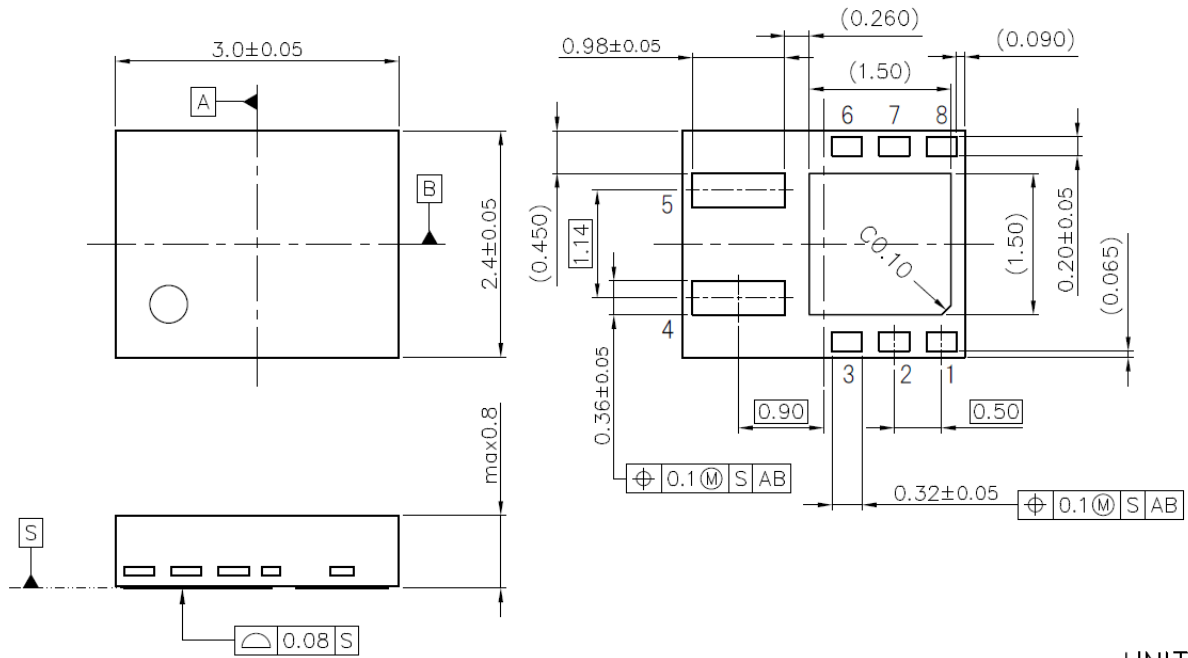

UNIT: mm

QFN2430-8 Package Dimensions

①②③④: Product Code ... Refer to *Part Marking List*

⑤⑥: Lot Number ... Alphanumeric Serial Number

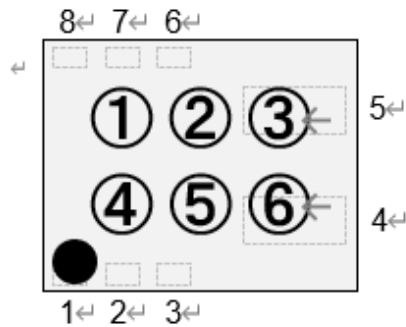

QFN2430-8 Part Markings

NOTICE

There can be variation in the marking when different AOI (Automated Optical Inspection) equipment is used. In the case of recognizing the marking characteristic with AOI, please contact our sales or distributor before attempting to use AOI.

RM516L Part Marking List

Product Name	①	②	③	④	Product Name	①	②	③	④
RM516L031A	A	0	0	A	RM516L031B	B	0	0	A
RM516L041A	A	0	1	A	RM516L041B	B	0	1	A
RM516L051A	A	0	2	A	RM516L051B	B	0	2	A
RM516L061A	A	0	3	A	RM516L061B	B	0	3	A
RM516L071A	A	0	4	A	RM516L071B	B	0	4	A
RM516L081A	A	0	5	A	RM516L081B	B	0	5	A
RM516L091A	A	0	6	A	RM516L091B	B	0	6	A
RM516L101A	A	0	7	A	RM516L101B	B	0	7	A
RM516L111A	A	0	8	A	RM516L111B	B	0	8	A
RM516L121A	A	0	9	A	RM516L121B	B	0	9	A

1. The products and the product specifications described in this document are subject to change or discontinuation of production without notice for reasons such as improvement. Therefore, before deciding to use the products, please refer to our sales representatives for the latest information thereon.
2. The materials in this document may not be copied or otherwise reproduced in whole or in part without the prior written consent of us.
3. This product and any technical information relating thereto are subject to complementary export controls (so-called KNOW controls) under the Foreign Exchange and Foreign Trade Law, and related politics ministerial ordinance of the law. (Note that the complementary export controls are inapplicable to any application-specific products, except rockets and pilotless aircraft, that are insusceptible to design or program changes.) Accordingly, when exporting or carrying abroad this product, follow the Foreign Exchange and Foreign Trade Control Law and its related regulations with respect to the complementary export controls.
4. The technical information described in this document shows typical characteristics and example application circuits for the products. The release of such information is not to be construed as a warranty of or a grant of license under our or any third party's intellectual property rights or any other rights.
5. The products listed in this document are intended and designed for use as general electronic components in standard applications (office equipment, telecommunication equipment, measuring instruments, consumer electronic products, amusement equipment etc.). Those customers intending to use a product in an application requiring extreme quality and reliability, for example, in a highly specific application where the failure or misoperation of the product could result in human injury or death should first contact us.
 - Aerospace Equipment
 - Equipment Used in the Deep Sea
 - Power Generator Control Equipment (nuclear, steam, hydraulic, etc.)
 - Life Maintenance Medical Equipment
 - Fire Alarms / Intruder Detectors
 - Vehicle Control Equipment (automotive, airplane, railroad, ship, etc.)
 - Various Safety Devices
 - Traffic control system
 - Combustion equipment

In case your company desires to use this product for any applications other than general electronic equipment mentioned above, make sure to contact our company in advance. Note that the important requirements mentioned in this section are not applicable to cases where operation requirements such as application conditions are confirmed by our company in writing after consultation with your company.

6. We are making our continuous effort to improve the quality and reliability of our products, but semiconductor products are likely to fail with certain probability. In order to prevent any injury to persons or damages to property resulting from such failure, customers should be careful enough to incorporate safety measures in their design, such as redundancy feature, fire containment feature and fail-safe feature. We do not assume any liability or responsibility for any loss or damage arising from misuse or inappropriate use of the products.
7. The products have been designed and tested to function within controlled environmental conditions. Do not use products under conditions that deviate from methods or applications specified in this datasheet. Failure to employ the products in the proper applications can lead to deterioration, destruction or failure of the products. We shall not be responsible for any bodily injury, fires or accident, property damage or any consequential damages resulting from misuse or misapplication of the products.
8. **Quality Warranty**
 - 8-1. **Quality Warranty Period**

In the case of a product purchased through an authorized distributor or directly from us, the warranty period for this product shall be one (1) year after delivery to your company. For defective products that occurred during this period, we will take the quality warranty measures described in section 8-2. However, if there is an agreement on the warranty period in the basic transaction agreement, quality assurance agreement, delivery specifications, etc., it shall be followed.
 - 8-2. **Quality Warranty Remedies**

When it has been proved defective due to manufacturing factors as a result of defect analysis by us, we will either deliver a substitute for the defective product or refund the purchase price of the defective product.

Note that such delivery or refund is sole and exclusive remedies to your company for the defective product.
 - 8-3. **Remedies after Quality Warranty Period**

With respect to any defect of this product found after the quality warranty period, the defect will be analyzed by us. On the basis of the defect analysis results, the scope and amounts of damage shall be determined by mutual agreement of both parties. Then we will deal with upper limit in Section 8-2. This provision is not intended to limit any legal rights of your company.
9. Anti-radiation design is not implemented in the products described in this document.
10. The X-ray exposure can influence functions and characteristics of the products. Confirm the product functions and characteristics in the evaluation stage.
11. WLCSP products should be used in light shielded environments. The light exposure can influence functions and characteristics of the products under operation or storage.
12. Warning for handling Gallium and Arsenic (GaAs) products (Applying to GaAs MMIC, Photo Reflector). These products use Gallium (Ga) and Arsenic (As) which are specified as poisonous chemicals by law. For the prevention of a hazard, do not burn, destroy, or process chemically to make them as gas or power. When the product is disposed of, please follow the related regulation and do not mix this with general industrial waste or household waste.
13. Please contact our sales representatives should you have any questions or comments concerning the products or the technical information.



Nisshinbo Micro Devices Inc.

Official website

<https://www.nisshinbo-microdevices.co.jp/en/>

Purchase information

<https://www.nisshinbo-microdevices.co.jp/en/buy/>