

## XHP™3 module with Trench/Fieldstop IGBT3 and emitter controlled 3 diode

### Features

- Electrical features
  - $V_{CES} = 3300\text{ V}$
  - $I_{C\text{nom}} = 450\text{ A} / I_{CRM} = 900\text{ A}$
  - High DC stability
  - High short-circuit capability
  - Low switching losses
  - Low  $V_{CE,sat}$
  - $T_{vj,op} = 150^{\circ}\text{C}$
  - Unbeatable robustness
- Mechanical features
  - ALSiC base plate for increased thermal cycling capability
  - Isolated base plate
  - Package with CTI > 600
  - Package with enhanced insulation of 10.4 kV AC 60 s



### Potential applications

- Traction drives
- Medium-voltage converters
- Motor drives

### Product validation

- Qualified for industrial applications according to the relevant tests of IEC 60747, 60749 and 60068

### Description

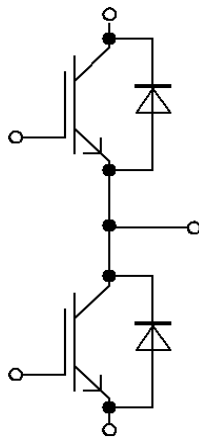

## Table of contents

	<b>Description</b> .....	1
	<b>Features</b> .....	1
	<b>Potential applications</b> .....	1
	<b>Product validation</b> .....	1
	<b>Table of contents</b> .....	2
<b>1</b>	<b>Package</b> .....	3
<b>2</b>	<b>IGBT, Inverter</b> .....	3
<b>3</b>	<b>Diode, Inverter</b> .....	5
<b>4</b>	<b>Characteristics diagrams</b> .....	7
<b>5</b>	<b>Circuit diagram</b> .....	11
<b>6</b>	<b>Package outlines</b> .....	12
<b>7</b>	<b>Module label code</b> .....	13
	<b>Revision history</b> .....	14
	<b>Disclaimer</b> .....	15

## 1 Package

**Table 1** Insulation coordination

Parameter	Symbol	Note or test condition	Values	Unit
Isolation test voltage	$V_{ISOL}$	RMS, $f = 50$ Hz, $t = 60$ s	10.4	kV
Partial discharge extinction voltage	$V_{isol}$	RMS, $f = 50$ Hz, $Q_{PD}$ typ. 10 pC	5.1	kV
Material of module baseplate			AlSiC	
Creepage distance	$d_{Creep}$	terminal to heatsink	53.0	mm
Creepage distance	$d_{Creep}$	terminal to terminal	53.0	mm
Clearance	$d_{Clear}$	terminal to heatsink	36.0	mm
Clearance	$d_{Clear}$	terminal to terminal	26.0	mm
Comparative tracking index	$CTI$		> 600	

**Table 2** Characteristic values

Parameter	Symbol	Note or test condition	Values			Unit	
			Min.	Typ.	Max.		
Stray inductance module	$L_{sCE}$			25		nH	
Module lead resistance, terminals - chip	$R_{AA'+CC'}$	$T_C=25^\circ\text{C}$ , per switch		0.31		mΩ	
Module lead resistance, terminals - chip	$R_{CC'+EE'}$	$T_C=25^\circ\text{C}$ , per switch		0.41		mΩ	
Storage temperature	$T_{stg}$		-40		150	°C	
Mounting torque for module mounting	$M$	- Mounting according to valid application note	M6, Screw	4.25		5.75	Nm
Terminal connection torque	$M$	- Mounting according to valid application note	M3, Screw	0.9		1.1	Nm
			M8, Screw	8		10	
Weight	$G$			700		g	

## 2 IGBT, Inverter

**Table 3** Maximum rated values

Parameter	Symbol	Note or test condition	Values	Unit	
Collector-emitter voltage	$V_{CES}$		$T_{vj} = -40^\circ\text{C}$	3300	V
			$T_{vj} = 150^\circ\text{C}$	3300	
Continuous DC collector current	$I_{CDC}$	$T_{vj\ max} = 150^\circ\text{C}$	$T_C = 100^\circ\text{C}$	450	A

(table continues...)

**Table 3 (continued) Maximum rated values**

Parameter	Symbol	Note or test condition	Values	Unit
Repetitive peak collector current	$I_{CRM}$	$t_p$ limited by $T_{vj\ op}$	900	A
Gate-emitter peak voltage	$V_{GES}$		±20	V

**Table 4 Characteristic values**

Parameter	Symbol	Note or test condition	Values			Unit
			Min.	Typ.	Max.	
Collector-emitter saturation voltage	$V_{CE\ sat}$	$I_C = 450\ A, V_{GE} = 15\ V$	$T_{vj} = 25\ ^\circ C$	2.50	2.75	V
			$T_{vj} = 125\ ^\circ C$	2.90		
			$T_{vj} = 150\ ^\circ C$	3.00	3.30	
Gate threshold voltage	$V_{GEth}$	$I_C = 12\ mA, V_{CE} = V_{GE}, T_{vj} = 25\ ^\circ C$	5.20	5.80	6.40	V
Gate charge	$Q_G$	$V_{GE} = \pm 15\ V, V_{CE} = 1800\ V$		12.5		μC
Internal gate resistor	$R_{Gint}$	$T_{vj} = 25\ ^\circ C$		1.3		Ω
Input capacitance	$C_{ies}$	$f = 1000\ kHz, T_{vj} = 25\ ^\circ C, V_{CE} = 25\ V, V_{GE} = 0\ V$		84		nF
Reverse transfer capacitance	$C_{res}$	$f = 1000\ kHz, T_{vj} = 25\ ^\circ C, V_{CE} = 25\ V, V_{GE} = 0\ V$		2		nF
Collector-emitter cut-off current	$I_{CES}$	$V_{CE} = 3300\ V, V_{GE} = 0\ V$	$T_{vj} = 25\ ^\circ C$		5	mA
Gate-emitter leakage current	$I_{GES}$	$V_{CE} = 0\ V, V_{GE} = 20\ V, T_{vj} = 25\ ^\circ C$			400	nA
Turn-on delay time (inductive load)	$t_{don}$	$I_C = 450\ A, V_{CE} = 1800\ V, V_{GE} = \pm 15\ V, R_{Gon} = 0.7\ \Omega$	$T_{vj} = 25\ ^\circ C$	0.530		μs
			$T_{vj} = 125\ ^\circ C$	0.570		
			$T_{vj} = 150\ ^\circ C$	0.580		
Rise time (inductive load)	$t_r$	$I_C = 450\ A, V_{CE} = 1800\ V, V_{GE} = \pm 15\ V, R_{Gon} = 0.7\ \Omega$	$T_{vj} = 25\ ^\circ C$	0.100		μs
			$T_{vj} = 125\ ^\circ C$	0.130		
			$T_{vj} = 150\ ^\circ C$	0.130		
Turn-off delay time (inductive load)	$t_{doff}$	$I_C = 450\ A, V_{CE} = 1800\ V, V_{GE} = \pm 15\ V, R_{Goff} = 3.3\ \Omega$	$T_{vj} = 25\ ^\circ C$	1.710		μs
			$T_{vj} = 125\ ^\circ C$	1.860		
			$T_{vj} = 150\ ^\circ C$	1.920		
Fall time (inductive load)	$t_f$	$I_C = 450\ A, V_{CE} = 1800\ V, V_{GE} = \pm 15\ V, R_{Goff} = 3.3\ \Omega$	$T_{vj} = 25\ ^\circ C$	0.130		μs
			$T_{vj} = 125\ ^\circ C$	0.240		
			$T_{vj} = 150\ ^\circ C$	0.270		
Turn-on time (resistive load)	$t_{on\_R}$	$I_C = 500\ A, V_{CE} = 2000\ V, V_{GE} = \pm 15\ V, R_{Gon} = 0.7\ \Omega$	$T_{vj} = 25\ ^\circ C$	1.15		μs

(table continues...)

**Table 4 (continued) Characteristic values**

Parameter	Symbol	Note or test condition	Values			Unit
			Min.	Typ.	Max.	
Turn-on energy loss per pulse	$E_{on}$	$I_C = 450\text{ A}$ , $V_{CE} = 1800\text{ V}$ , $L_\sigma = 85\text{ nH}$ , $V_{GE} = \pm 15\text{ V}$ , $R_{Gon} = 0.7\ \Omega$ , $di/dt = 3650\text{ A}/\mu\text{s}$ ( $T_{vj} = 150\text{ }^\circ\text{C}$ )	$T_{vj} = 25\text{ }^\circ\text{C}$	500		mJ
			$T_{vj} = 125\text{ }^\circ\text{C}$	765		
			$T_{vj} = 150\text{ }^\circ\text{C}$	845		
Turn-off energy loss per pulse	$E_{off}$	$I_C = 450\text{ A}$ , $V_{CE} = 1800\text{ V}$ , $L_\sigma = 85\text{ nH}$ , $V_{GE} = \pm 15\text{ V}$ , $R_{Goff} = 3.3\ \Omega$ , $dv/dt = 2850\text{ V}/\mu\text{s}$ ( $T_{vj} = 150\text{ }^\circ\text{C}$ )	$T_{vj} = 25\text{ }^\circ\text{C}$	415		mJ
			$T_{vj} = 125\text{ }^\circ\text{C}$	610		
			$T_{vj} = 150\text{ }^\circ\text{C}$	670		
SC data	$I_{SC}$	$V_{GE} \leq 15\text{ V}$ , $V_{CC} = 2500\text{ V}$ , $V_{CEmax} = V_{CES} - L_{sCE} \cdot di/dt$	$t_p \leq 10\ \mu\text{s}$ , $T_{vj} \leq 150\text{ }^\circ\text{C}$	1800		A
Thermal resistance, junction to case	$R_{thJC}$	per IGBT			28.4	K/kW
Thermal resistance, case to heat sink	$R_{thCH}$	per IGBT, $\lambda_{grease} = 1\text{ W}/(\text{m} \cdot \text{K})$		17.4		K/kW
Temperature under switching conditions	$T_{vjop}$		-40		150	$^\circ\text{C}$

### 3 Diode, Inverter

**Table 5 Maximum rated values**

Parameter	Symbol	Note or test condition	Values	Unit	
Repetitive peak reverse voltage	$V_{RRM}$		$T_{vj} = -40\text{ }^\circ\text{C}$	3300	V
			$T_{vj} = 150\text{ }^\circ\text{C}$	3300	
Continuous DC forward current	$I_F$		450	A	
Repetitive peak forward current	$I_{FRM}$	$t_p = 1\text{ ms}$	900	A	
$I^2t$ - value	$I^2t$	$t_p = 10\text{ ms}$ , $V_R = 0\text{ V}$	$T_{vj} = 125\text{ }^\circ\text{C}$	82.9	kA <sup>2</sup> s
			$T_{vj} = 150\text{ }^\circ\text{C}$	68	
Maximum power dissipation	$P_{RQM}$		$T_{vj} = 150\text{ }^\circ\text{C}$	1000	kW
Minimum turn-on time	$t_{onmin}$			10	$\mu\text{s}$

**Table 6** Characteristic values

Parameter	Symbol	Note or test condition	Values			Unit	
			Min.	Typ.	Max.		
Forward voltage	$V_F$	$I_F = 450 \text{ A}, V_{GE} = 0 \text{ V}$	$T_{vj} = 25 \text{ °C}$		3.10	3.50	V
			$T_{vj} = 125 \text{ °C}$		2.75		
			$T_{vj} = 150 \text{ °C}$		2.65	2.95	
Peak reverse recovery current	$I_{RM}$	$V_R = 1800 \text{ V}, I_F = 450 \text{ A}, V_{GE} = -15 \text{ V}, -di_F/dt = 3650 \text{ A}/\mu\text{s} (T_{vj} = 150 \text{ °C})$	$T_{vj} = 25 \text{ °C}$		680		A
			$T_{vj} = 125 \text{ °C}$		680		
			$T_{vj} = 150 \text{ °C}$		680		
Recovered charge	$Q_r$	$V_R = 1800 \text{ V}, I_F = 450 \text{ A}, V_{GE} = -15 \text{ V}, -di_F/dt = 3650 \text{ A}/\mu\text{s} (T_{vj} = 150 \text{ °C})$	$T_{vj} = 25 \text{ °C}$		230		$\mu\text{C}$
			$T_{vj} = 125 \text{ °C}$		445		
			$T_{vj} = 150 \text{ °C}$		525		
Reverse recovery energy	$E_{rec}$	$V_R = 1800 \text{ V}, I_F = 450 \text{ A}, V_{GE} = -15 \text{ V}, -di_F/dt = 3650 \text{ A}/\mu\text{s} (T_{vj} = 150 \text{ °C})$	$T_{vj} = 25 \text{ °C}$		220		mJ
			$T_{vj} = 125 \text{ °C}$		490		
			$T_{vj} = 150 \text{ °C}$		595		
Thermal resistance, junction to case	$R_{thJC}$	per diode			45.5	K/kW	
Thermal resistance, case to heat sink	$R_{thCH}$	per diode, $\lambda_{grease} = 1 \text{ W}/(\text{m}^*\text{K})$			19.3	K/kW	
Temperature under switching conditions	$T_{vj op}$		-40		150	°C	

## 4 Characteristics diagrams

**Output characteristic (typical), IGBT, Inverter**

$I_C = f(V_{CE})$   
 $V_{GE} = 15 \text{ V}$

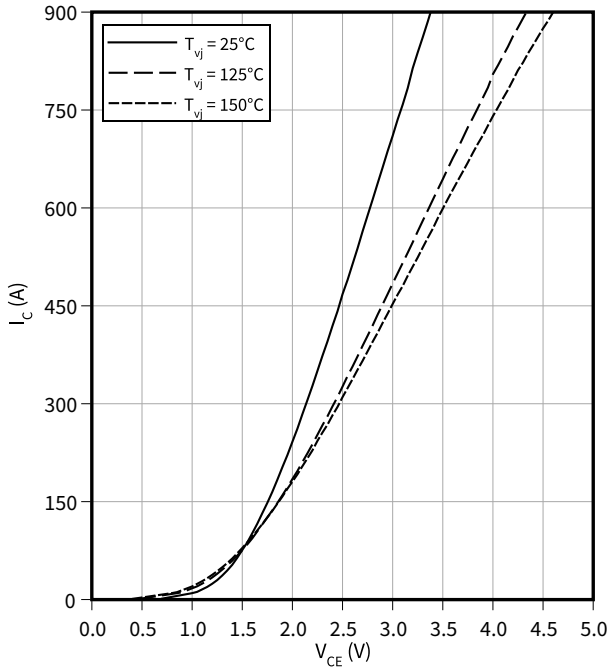

**Output characteristic field (typical), IGBT, Inverter**

$I_C = f(V_{CE})$   
 $T_{vj} = 150 \text{ °C}$

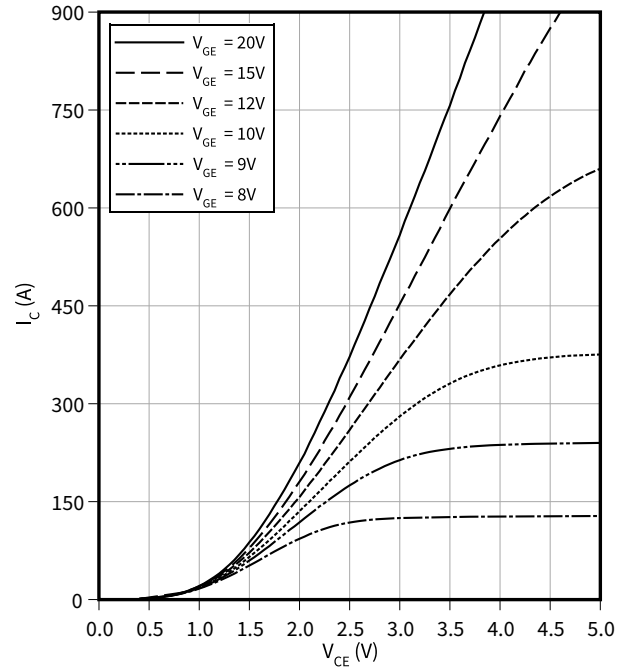

**Transfer characteristic (typical), IGBT, Inverter**

$I_C = f(V_{GE})$   
 $V_{CE} = 20 \text{ V}$

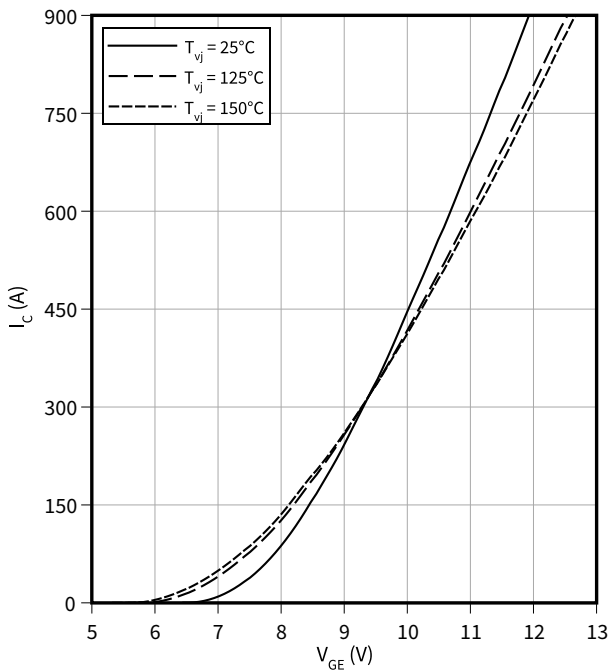

**Switching losses (typical), IGBT, Inverter**

$E = f(I_C)$   
 $R_{Goff} = 3.3 \text{ } \Omega$ ,  $R_{Gon} = 0.7 \text{ } \Omega$ ,  $V_{CE} = 1800 \text{ V}$ ,  $V_{GE} = \pm 15 \text{ V}$

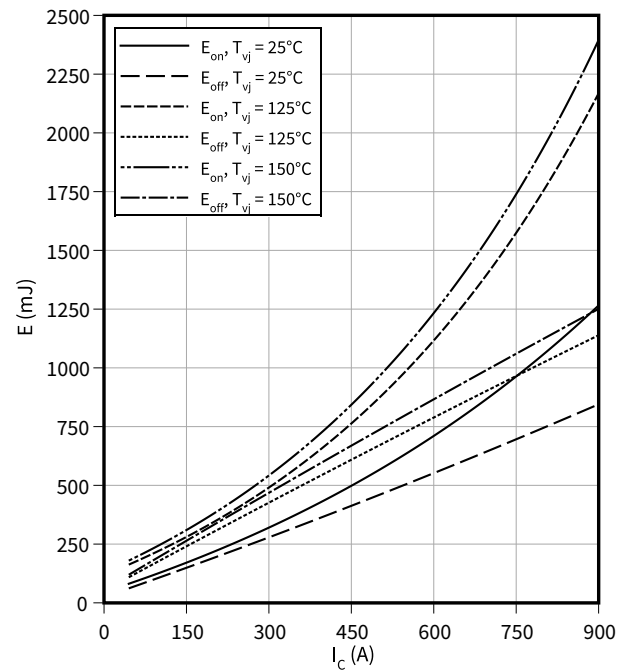

**4 Characteristics diagrams**

**Switching losses (typical), IGBT, Inverter**

$E = f(R_G)$

$I_C = 450 \text{ A}, V_{CE} = 1800 \text{ V}, V_{GE} = \pm 15 \text{ V}$

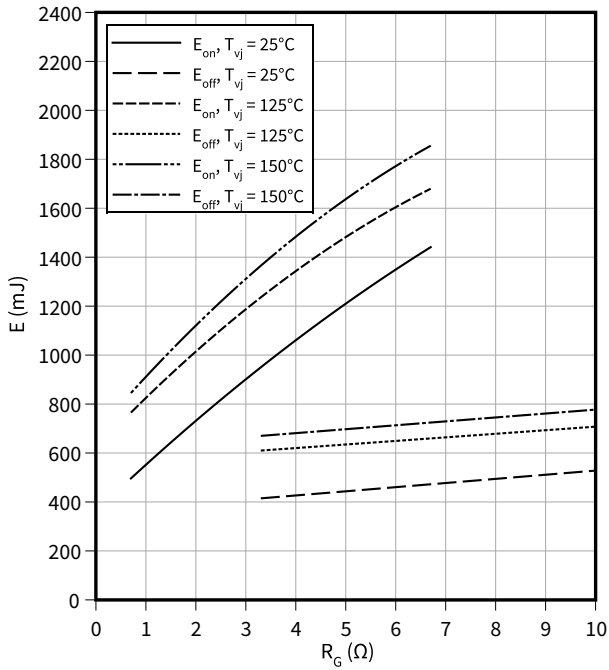

**Switching times (typical), IGBT, Inverter**

$t = f(I_C)$

$R_{Goff} = 3.3 \text{ } \Omega, R_{Gon} = 0.7 \text{ } \Omega, V_{CE} = 1800 \text{ V}, V_{GE} = \pm 15 \text{ V}, T_{vj} = 150 \text{ } ^\circ\text{C}$

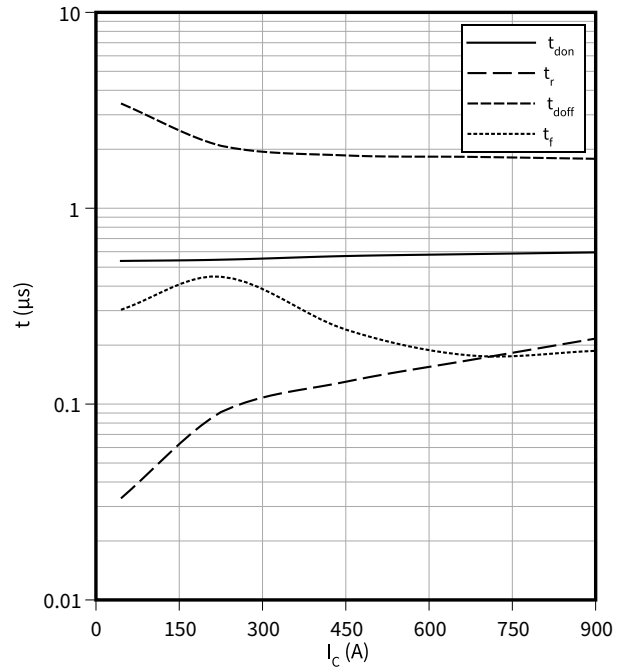

**Switching times (typical), IGBT, Inverter**

$t = f(R_G)$

$I_C = 450 \text{ A}, V_{CE} = 1800 \text{ V}, V_{GE} = \pm 15 \text{ V}, T_{vj} = 150 \text{ } ^\circ\text{C}$

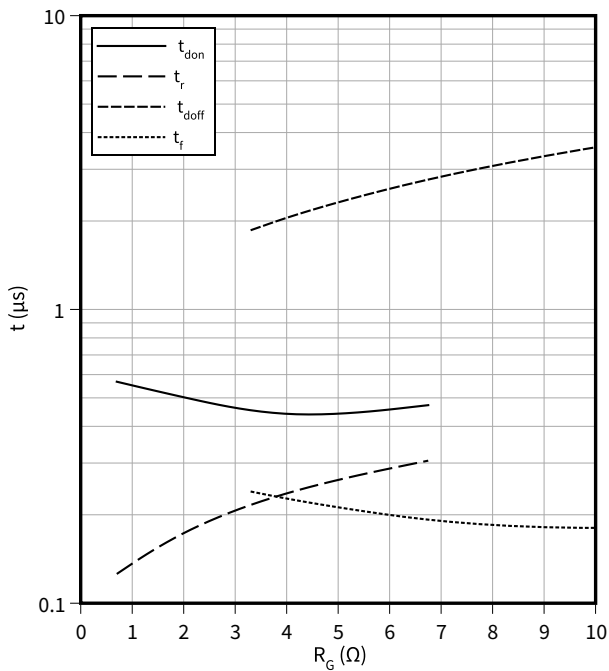

**Transient thermal impedance, IGBT, Inverter**

$Z_{th} = f(t)$

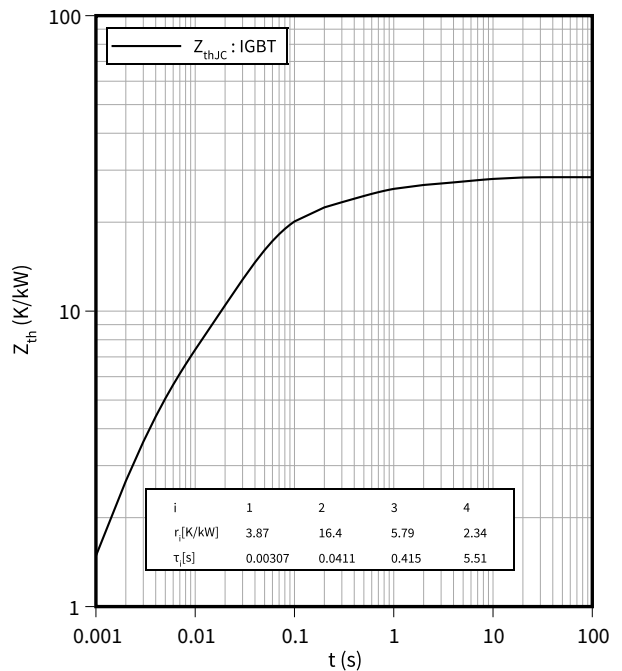



4 Characteristics diagrams

**Reverse bias safe operating area (RBSOA), IGBT, Inverter**

$I_C = f(V_{CE})$

$R_{Goff} = 3.3 \Omega$ ,  $V_{GE} = \pm 15 \text{ V}$ ,  $T_{vj} = 150 \text{ }^\circ\text{C}$

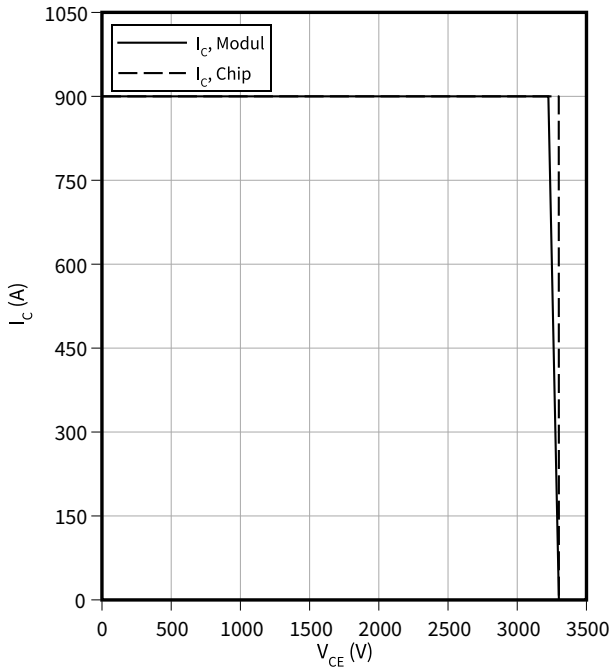

**Capacity characteristic (typical), IGBT, Inverter**

$C = f(V_{CE})$

$f = 1000 \text{ kHz}$ ,  $V_{GE} = 0 \text{ V}$ ,  $T_{vj} = 25 \text{ }^\circ\text{C}$

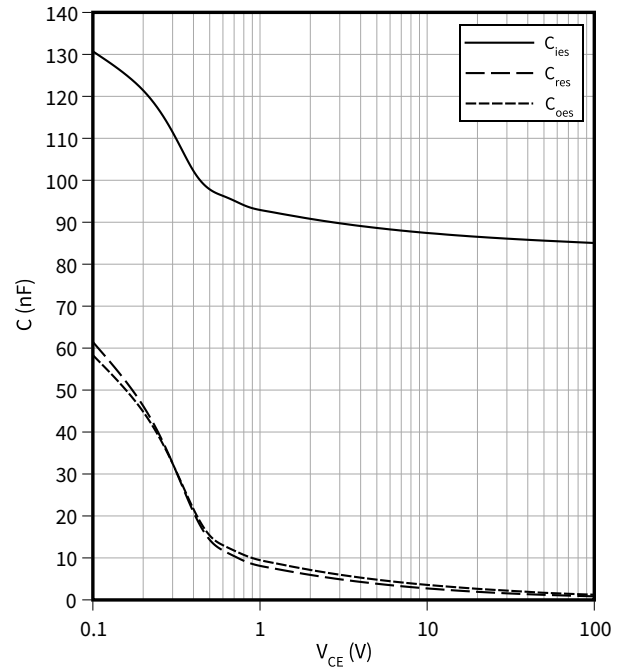

**Gate charge characteristic (typical), IGBT, Inverter**

$V_{GE} = f(Q_G)$

$I_C = 450 \text{ A}$ ,  $T_{vj} = 25 \text{ }^\circ\text{C}$

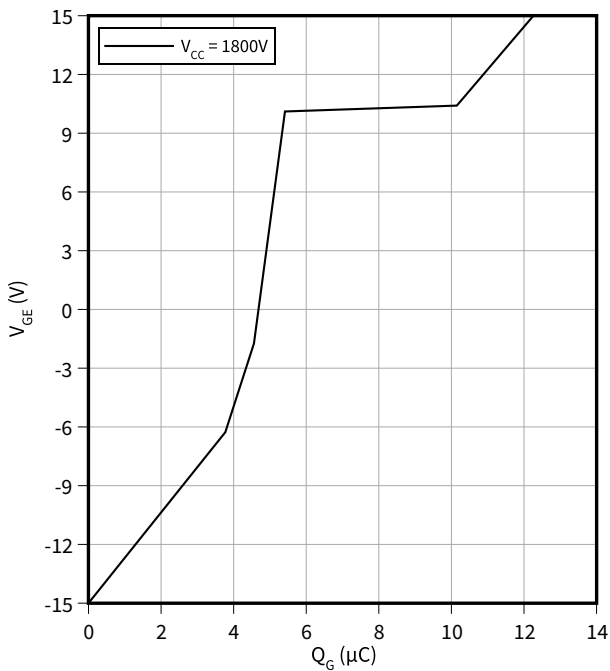

**Forward characteristic (typical), Diode, Inverter**

$I_F = f(V_F)$

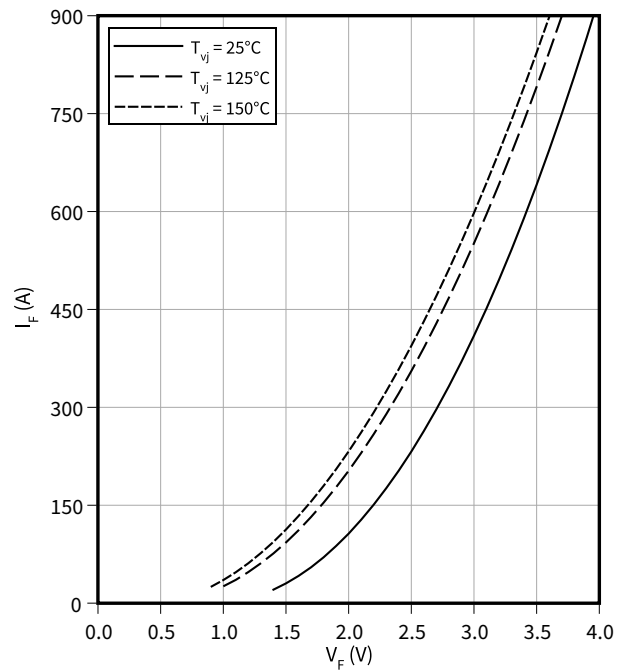

4 Characteristics diagrams

**Switching losses (typical), Diode, Inverter**

$E_{rec} = f(I_F)$

$V_{CE} = 1800\text{ V}$ ,  $R_{Gon} = R_{Gon}(IGBT)$

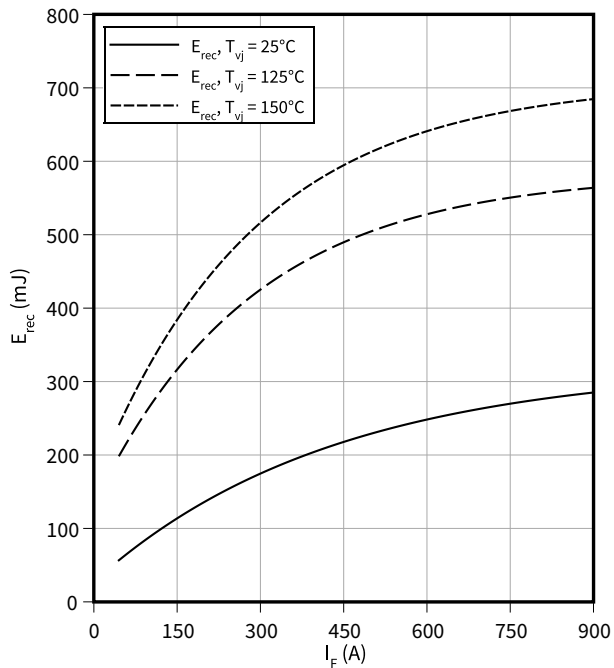

**Switching losses (typical), Diode, Inverter**

$E_{rec} = f(R_G)$

$V_{CE} = 1800\text{ V}$ ,  $I_F = 450\text{ A}$

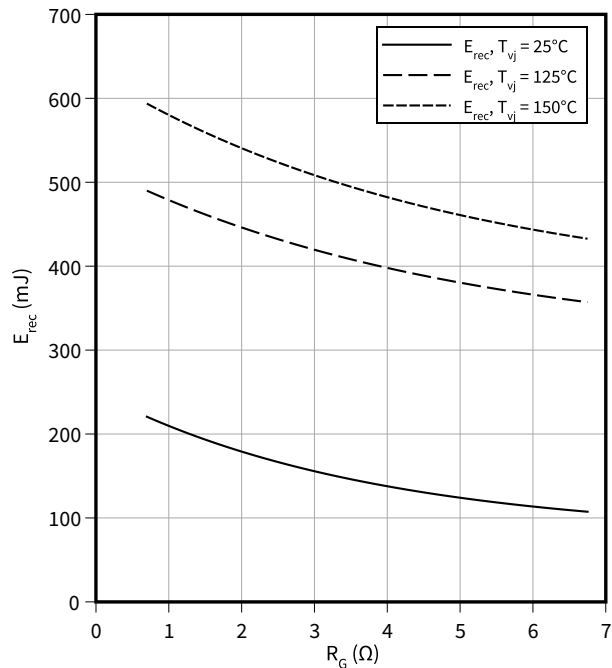

**Transient thermal impedance, Diode, Inverter**

$Z_{th} = f(t)$

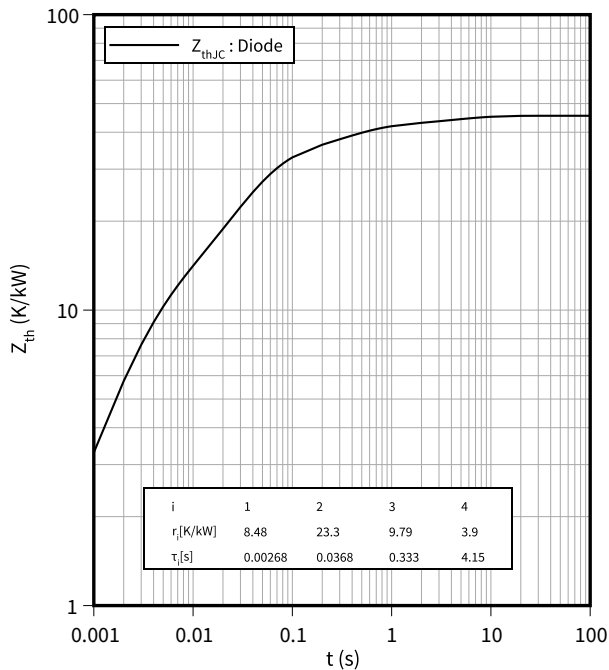

**Safe operating area (SOA), Diode, Inverter**

$I_R = f(V_R)$

$T_{vj} = 150\text{ °C}$

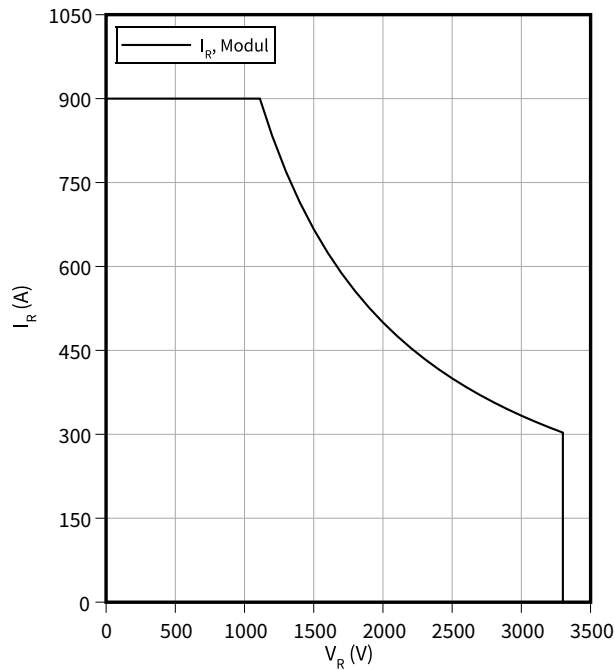

## 5 Circuit diagram

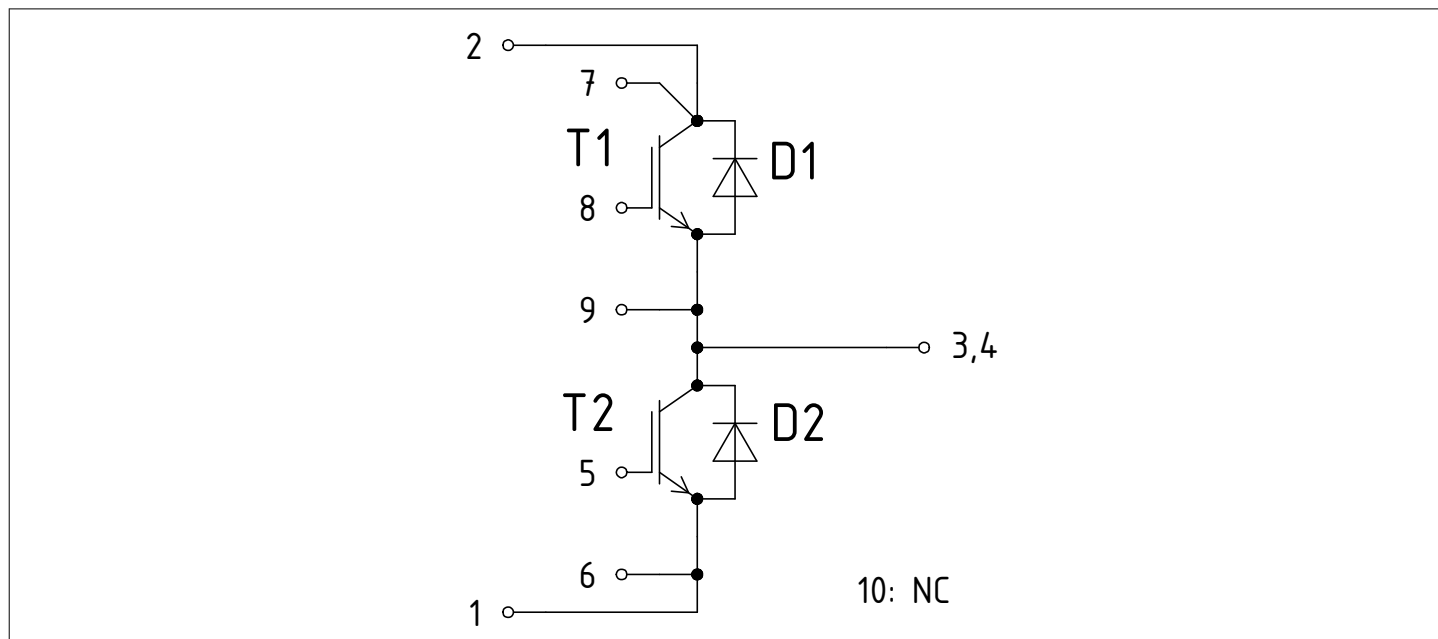

Figure 1

## 6 Package outlines

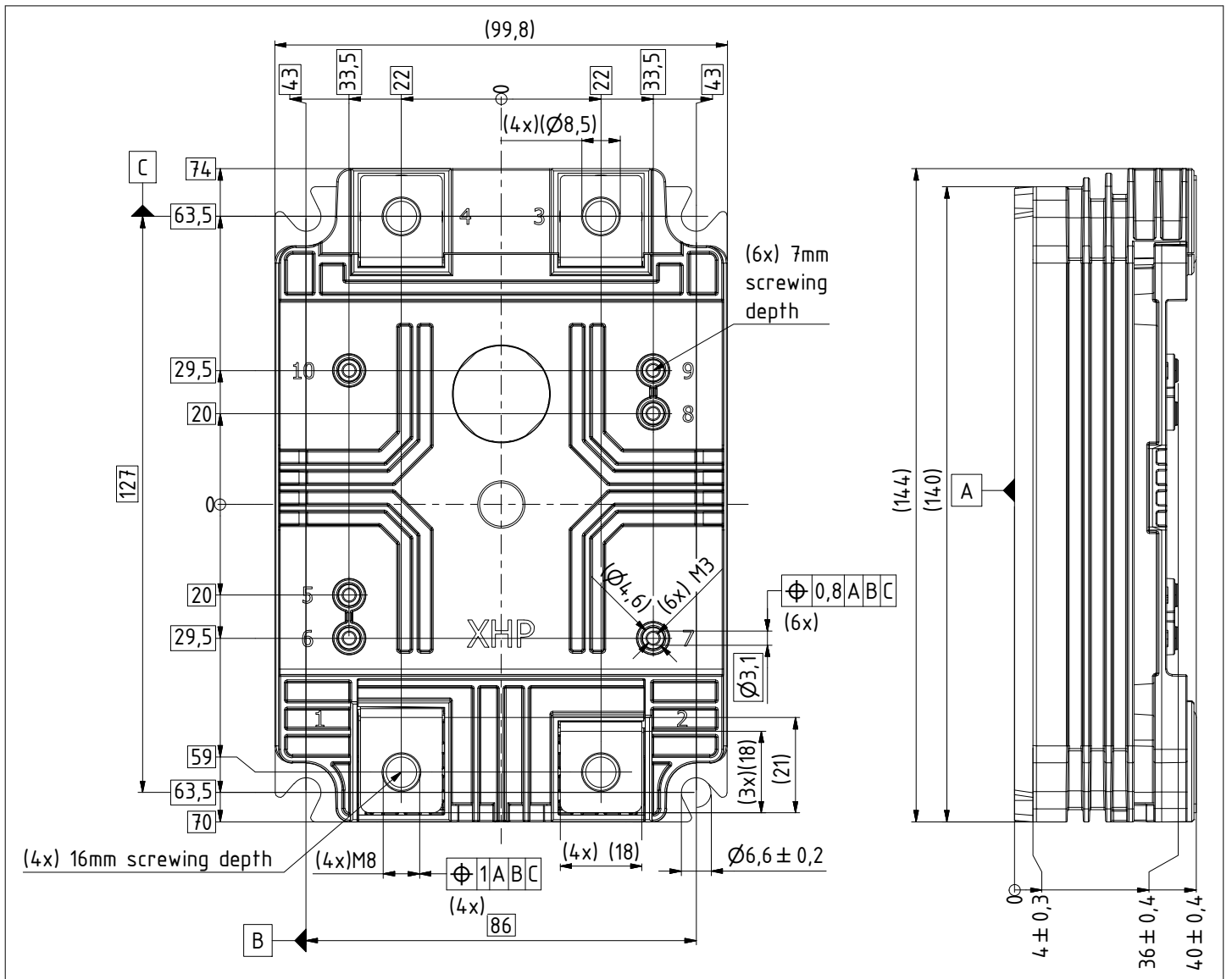

Figure 2

## 7 Module label code

Module label code			
Code format	Data Matrix	Barcode Code128	
Encoding	ASCII text	Code Set A	
Symbol size	16x16	23 digits	
Standard	IEC24720 and IEC16022	IEC8859-1	
Code content	Content	Digit	Example
	Module serial number	1 - 5	71549
	Module material number	6 - 11	142846
	Production order number	12 - 19	55054991
	Date code (production year)	20 - 21	15
	Date code (production week)	22 - 23	30
Example	 		
	71549142846550549911530		71549142846550549911530

Figure 3

## Revision history

Document revision	Date of release	Description of changes
V2.0	2018-10-08	Preliminary datasheet
V3.0	2019-01-28	Final datasheet
V3.1	2020-01-27	Final datasheet
n/a	2020-09-01	Datasheet migrated to a new system with a new layout and new revision number schema: target or preliminary datasheet = 0.xy; final datasheet = 1.xy
1.10	2021-11-04	Final datasheet
1.20	2022-04-06	Final datasheet

## Trademarks

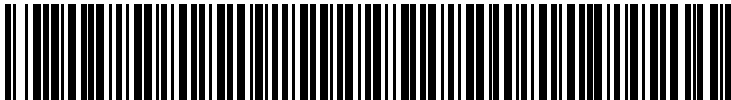
All referenced product or service names and trademarks are the property of their respective owners.

**Edition 2022-04-06**

**Published by**

**Infineon Technologies AG**

**81726 Munich, Germany**

**© 2022 Infineon Technologies AG**

**All Rights Reserved.**

**Do you have a question about any aspect of this document?**

**Email: [erratum@infineon.com](mailto:erratum@infineon.com)**

**Document reference**

**IFX-AAY096-005**

## IMPORTANT NOTICE

The information given in this document shall in no event be regarded as a guarantee of conditions or characteristics ("Beschaffheitsgarantie").

With respect to any examples, hints or any typical values stated herein and/or any information regarding the application of the product, Infineon Technologies hereby disclaims any and all warranties and liabilities of any kind, including without limitation warranties of non-infringement of intellectual property rights of any third party.

In addition, any information given in this document is subject to customer's compliance with its obligations stated in this document and any applicable legal requirements, norms and standards concerning customer's products and any use of the product of Infineon Technologies in customer's applications.

The data contained in this document is exclusively intended for technically trained staff. It is the responsibility of customer's technical departments to evaluate the suitability of the product for the intended application and the completeness of the product information given in this document with respect to such application.

## WARNINGS

Due to technical requirements products may contain dangerous substances. For information on the types in question please contact your nearest Infineon Technologies office.

Except as otherwise explicitly approved by Infineon Technologies in a written document signed by authorized representatives of Infineon Technologies, Infineon Technologies' products may not be used in any applications where a failure of the product or any consequences of the use thereof can reasonably be expected to result in personal injury.