

## MJD117-HF (PNP)

RoHS Device  
Halogen Free

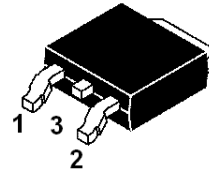

### Features

- High DC current gain.
- Built-in a damper diode at E-C.
- Lead formed for surface mount applications.
- Straight lead.

### Mechanical data

- Case: TO-252, molded plastic.
- Mounting position: Any.

### Circuit Diagram

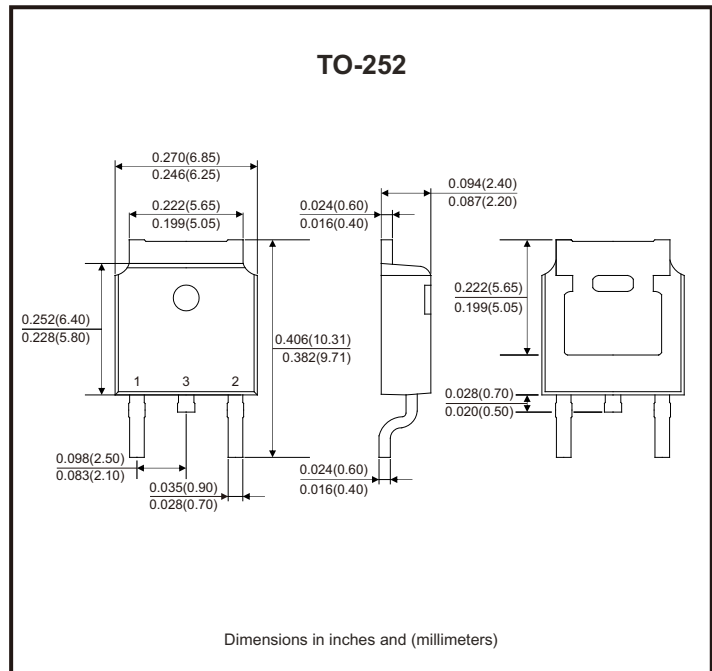
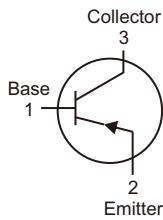

### Maximum Ratings (Operating temperature range applies unless otherwise specified)

Parameter	Symbol	Value	Units
Collector-base voltage	$V_{CBO}$	-100	V
Collector-emitter voltage	$V_{CEO}$	-100	V
Emitter-base voltage	$V_{EBO}$	-5	V
Collector current	$I_C$	-2	A
Peak collector current	$I_{CM}$	-4	A
Base current	$I_B$	-50	mA
Collector power dissipation	$P_C$	1.5	W
Junction and storage temperature range	$T_J, T_{STG}$	-65 to +150	°C

## Electrical Characteristics (at Ta=25°C unless otherwise noted)

Parameter	Conditions	Symbol	Min	Typ	Max	Units
Collector-emitter sustaining voltage	$I_C = -30\text{mA}$ , $I_B = 0$	$V_{CEO(sus)}$	-100			V
Collector cut-off current	$V_{CE} = -50\text{V}$ , $I_B = 0$	$I_{CEO}$			-20	$\mu\text{A}$
Collector cut-off current	$V_{CB} = -100\text{V}$ , $I_E = 0$	$I_{CBO}$			-20	$\mu\text{A}$
Emitter cut-off current	$V_{EB} = -5\text{V}$ , $I_C = 0$	$I_{EBO}$			-2	mA
DC current gain	$V_{CE} = -3\text{V}$ , $I_C = -0.5\text{mA}$ $V_{CE} = -3\text{V}$ , $I_C = -2\text{mA}$ $V_{CE} = -3\text{V}$ , $I_C = -4\text{mA}$	$h_{FE}$	500 1000 200		12000	
Collector-emitter saturation voltage	$I_C = -2\text{A}$ , $I_B = -8\text{mA}$ $I_C = -4\text{A}$ , $I_B = -40\text{mA}$	$V_{CE(sat)}$			-2 -3	V
Base-emitter saturation voltage	$I_C = -4\text{A}$ , $I_B = -40\text{mA}$	$V_{BE(sat)}$			-4	V
Base-emitter on voltage	$V_{CE} = -3\text{V}$ , $I_C = -2\text{A}$	$V_{BE(on)}$			-2.8	V
Transition frequency	$V_{CE} = -10\text{V}$ , $I_C = -0.75\text{A}$	$f_T$	25			MHz
Output capacity	$V_{CB} = -10\text{V}$ , $I_E = 0$ , $f = 0.1\text{MHz}$	$C_{ob}$			200	pF

## Rating and Characteristic Curves (MJD117-HF)

Fig.1 - DC Current Gain

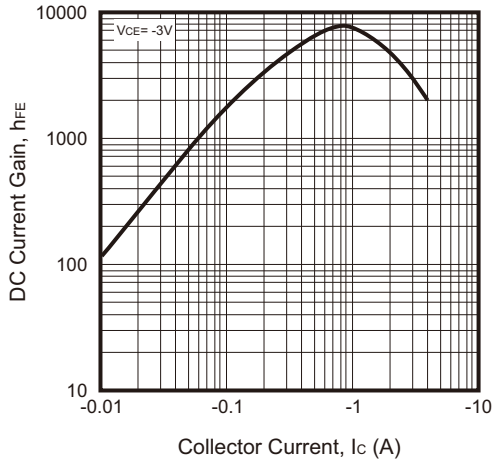

Fig.2 - Base-Emitter Saturation Voltage  
Collector-Emitter Saturation Voltage

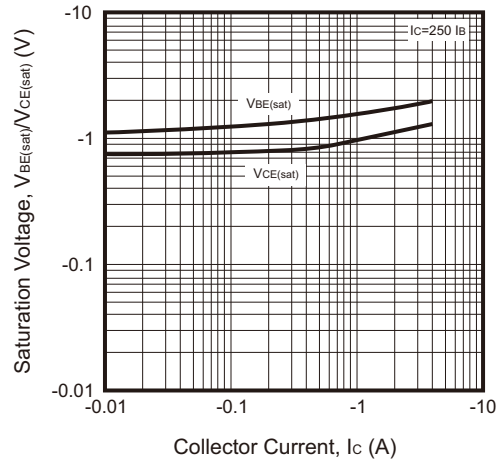

Fig.3 - Collector Output Capacitance

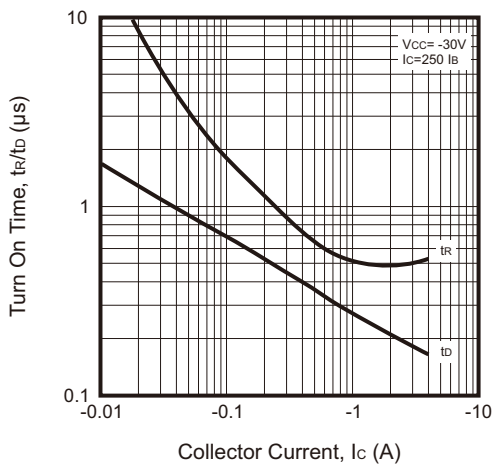

Fig.4 - Turn On Time

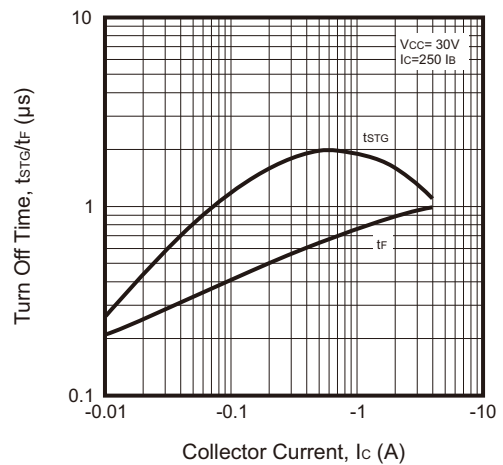

Fig.5 - Turn Off Time

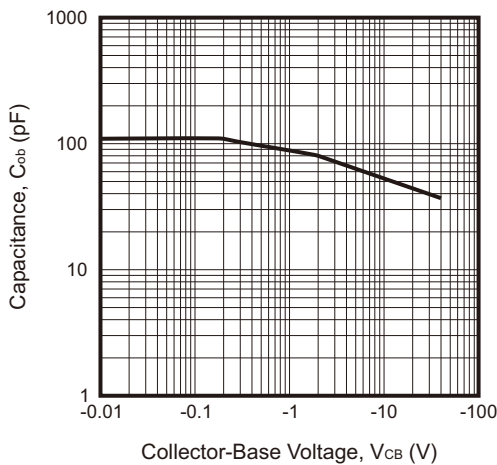
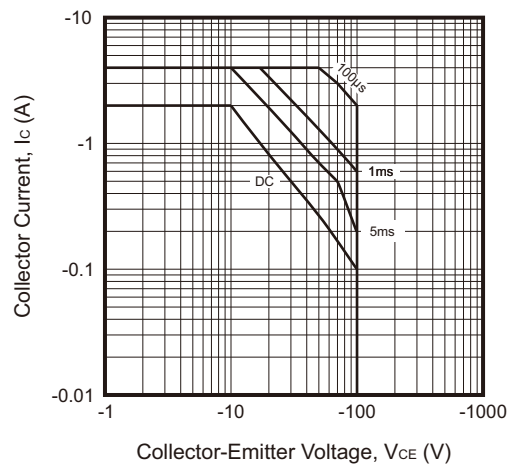
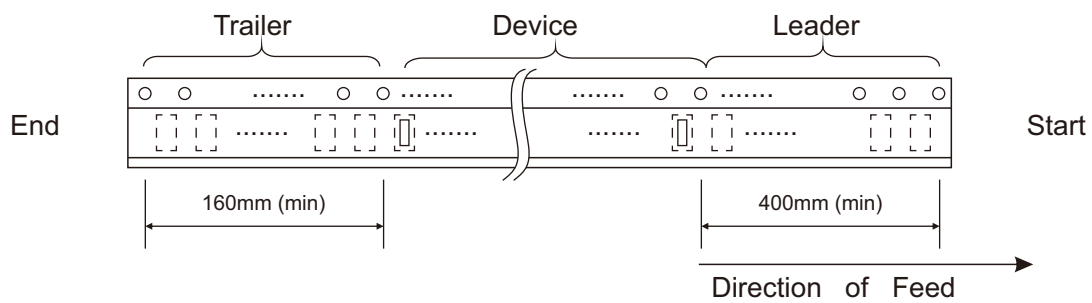
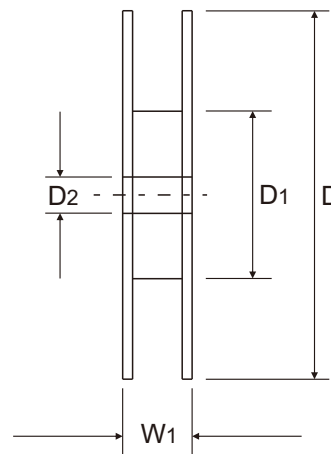
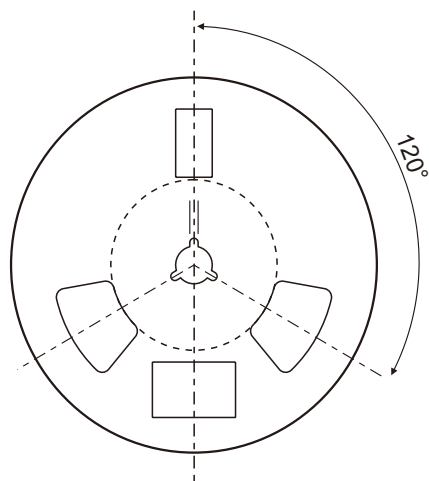
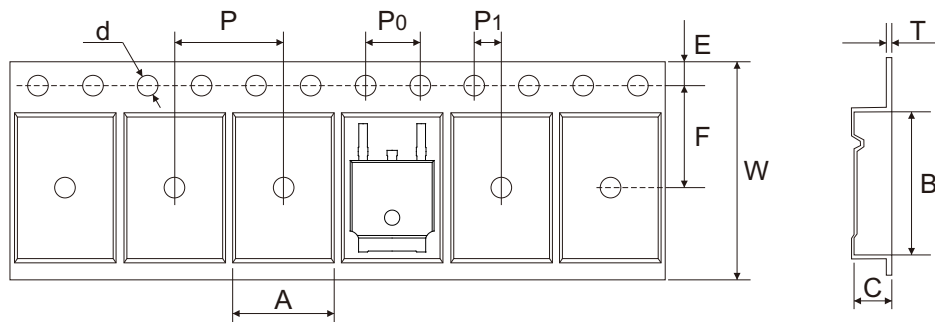

Fig.6 - Safe Operating Area



## Reel Taping Specification



TO-252	SYMBOL	A	B	C	d	D	D1	D2
	(mm)	6.90 ± 0.10	10.50 ± 0.10	2.70 ± 0.10	1.50 + 0.25	330 ± 1.00	100 ± 1.00	13.00 ± 0.20
	(inch)	0.272 ± 0.004	0.413 ± 0.004	0.106 ± 0.004	0.059 + 0.010	12.992 ± 0.039	3.937 ± 0.039	0.512 ± 0.008

TO-252	SYMBOL	E	F	P	P0	P1	T	W	W1
	(mm)	1.75 ± 0.10	7.50 ± 0.10	8.00 ± 0.10	4.00 ± 0.10	2.00 ± 0.10	0.30 ± 0.10	16.00 + 0.30 - 0.20	21.00 ± 0.30
	(inch)	0.069 ± 0.004	0.295 ± 0.004	0.315 ± 0.004	0.157 ± 0.004	0.079 ± 0.004	0.012 ± 0.004	0.630 + 0.012 - 0.008	0.827 ± 0.012

## Marking Code

Part Number	Marking Code
MJD117-HF	MJD117

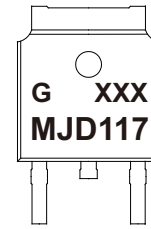

G / XXX = Control code

## Suggested P.C.B. PAD Layout

SIZE	TO-252	
	(mm)	(inch)
A	1.80	0.071
B	2.70	0.106
C	1.50	0.059
D	2.30	0.091
E	6.40	0.252
F	6.80	0.268

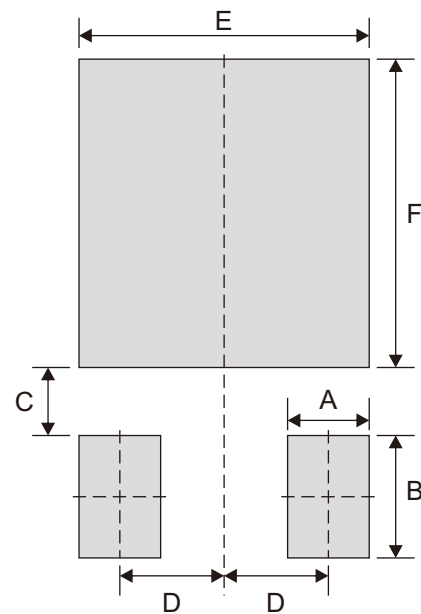

## Standard Packaging

Case Type	REEL PACK	
	REEL (pcs)	Reel Size (inch)
TO-252	2,500	13