

- 1536 × 1 Sensor-Element Organization
- 400 Dot-Per-Inch (DPI) Sensor Pitch
- High Linearity and Uniformity
- Wide Dynamic Range . . . 4000:1 (72 dB)
- Output Referenced to Ground
- Low Image Lag . . . 0.5% Typ
- Operation to 8 MHz
- Single 3-V to 5-V Supply
- Rail-to-Rail Output Swing (AO)
- No External Load Resistor Required

(TOP VIEW)

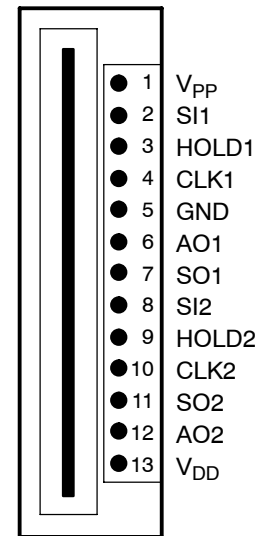

Description

The TSL1412S linear sensor array consists of 2 sections of 768 photodiodes, each with associated charge amplifier circuitry, aligned to form a contiguous 1536 × 1 pixel array. The device incorporates a pixel data-hold function that provides simultaneous-integration start and stop times for all pixels. The pixels measure 63.5 μm by 55.5 μm with 63.5-μm center-to-center spacing and 8-μm spacing between pixels. Operation is simplified by internal logic that requires only a serial-input (SI) pulse and a clock.

The device is intended for use in a wide variety of applications including mark and code reading, OCR and contact imaging, edge detection and positioning, and optical encoding.

Functional Block Diagram (each section)

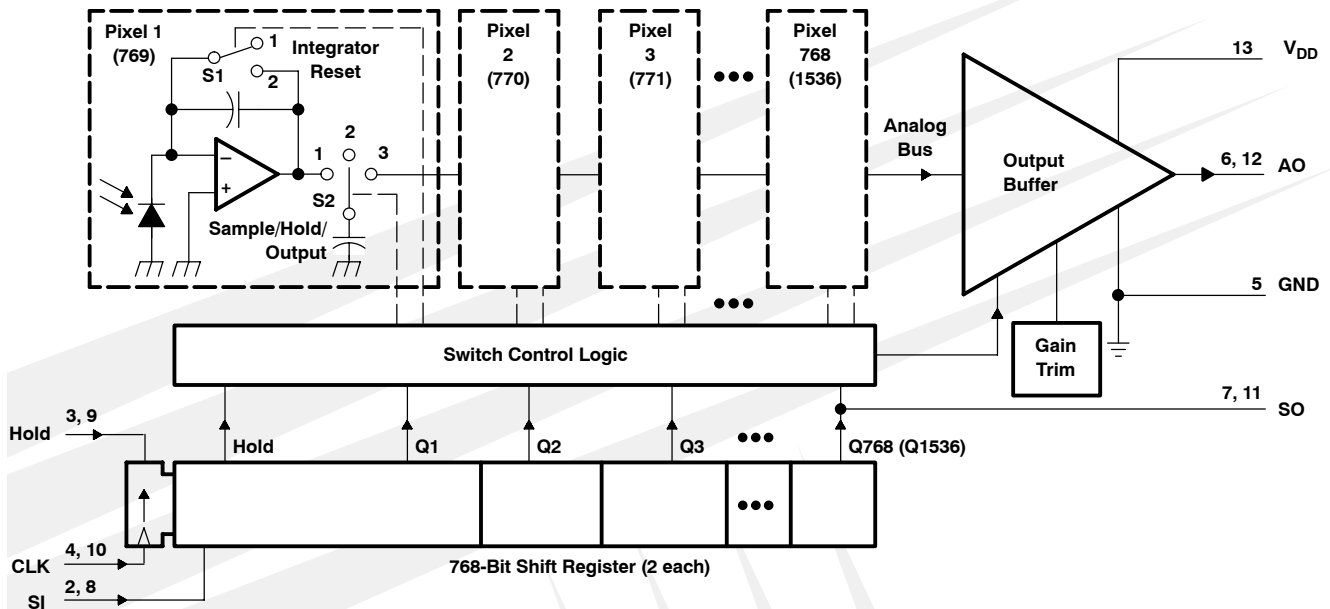

TSL1412S

1536 × 1 LINEAR SENSOR ARRAY WITH HOLD

TAOS045F – APRIL 2007

Terminal Functions

TERMINAL NAME	NO.	I/O	DESCRIPTION
AO1	6	O	Analog output, section 1.
AO2	12	O	Analog output, section 2.
CLK1	4	I	Clock, section 1. CLK1 controls charge transfer, pixel output, and reset.
CLK2	10	I	Clock, section 2. CLK2 controls charge transfer, pixel output, and reset.
GND	5		Ground (substrate). All voltages are referenced to GND.
HOLD1	3	I	Hold signal. HOLD1 shifts pixel data to parallel buffer. HOLD1 is normally connected to SI1 and HOLD2 in serial mode and to SI1 in parallel mode.
HOLD2	9	I	Hold signal. HOLD2 shifts pixel data to parallel buffer. HOLD2 is normally connected to SI2 in parallel mode.
SI1	2	I	Serial input (section 1). SI1 defines the start of the data-out sequence.
SI2	8	I	Serial input (section 2). SI2 defines the start of the data-out sequence.
SO1	7	O	Serial output (section 1). SO1 provides a signal to drive the SI2 input in serial mode.
SO2	11	O	Serial output (section 2). SO2 provides a signal to drive the SI input of another device for cascading or as an end-of-data indication.
V _{DD}	13		Supply voltage for both analog and digital circuitry.
V _{PP}	1		Normally grounded.

Detailed Description

The sensor consists of 1536 photodiodes, called pixels, arranged in a linear array. Light energy impinging on a pixel generates photocurrent that is then integrated by the active integration circuitry associated with that pixel.

During the integration period, a sampling capacitor connects to the output of the integrator through an analog switch. The amount of charge accumulated at each pixel is directly proportional to the light intensity on that pixel and the integration time.

The output and reset of the integrators are controlled by a 768-bit shift register and reset logic. An output cycle is initiated by clocking in a logic 1 on SI. Another signal, called HOLD, is generated from the rising edge of SI1 when SI1 and HOLD1 are connected together. This causes all 768 sampling capacitors to be disconnected from their respective integrators and starts an integrator reset period. As the SI pulse is clocked through the shift register, the charge stored on the sampling capacitors is sequentially connected to a charge-coupled output amplifier that generates a voltage on analog output AO. The integrator reset period ends 18 clock cycles after the SI pulse is clocked in. Then the next integration period begins. On the 768th clock rising edge, the SI pulse is clocked out on the SO1 pin (section 1) and becomes the SI pulse for section 2 (when SO1 is connected to SI2). The rising edge of the 769th clock cycle terminates the SO1 pulse, and returns the analog output AO of section 1 to high-impedance state. Similarly, SO2 is clocked out on the 1536th clock pulse. Note that a 1537th clock pulse is needed to terminate the SO2 pulse and return AO of Section 2 to the high-impedance state. If a minimum integration time is desired, the next SI pulse may be presented after a minimum delay of t_{qt} (pixel charge transfer time) after the 1537th clock pulse. Sections may be operated in parallel or in serial fashion.

AO is an op amp-type output that does not require an external pull-down resistor. This design allows a rail-to-rail output voltage swing. With $V_{DD} = 5\text{ V}$, the output is nominally 0 V for no light input, 2 V for normal white level, and 4.8 V for saturation light level. When the device is not in the output phase, AO is in a high-impedance state.

The voltage developed at analog output (AO) is given by:

$$V_{out} = V_{drk} + (R_e)(E_e)(t_{int})$$

where:

- V_{out} is the analog output voltage for white condition
- V_{drk} is the analog output voltage for dark condition
- R_e is the device responsivity for a given wavelength of light given in $V/(\mu\text{J}/\text{cm}^2)$
- E_e is the incident irradiance in $\mu\text{W}/\text{cm}^2$
- t_{int} is integration time in seconds

A 0.1 μF bypass capacitor should be connected between V_{DD} and ground as close as possible to the device.

Absolute Maximum Ratings over operating free-air temperature range (unless otherwise noted)†

Supply voltage range, V_{DD}	-0.3 V to 6 V
Input voltage range, V_I	-0.3 V to $V_{DD} + 0.3V$
Input clamp current, I_{IK} ($V_I < 0$) or ($V_I > V_{DD}$)	-20 mA to 20 mA
Output clamp current, I_{OK} ($V_O < 0$ or $V_O > V_{DD}$)	-25 mA to 25 mA
Voltage range applied to any output in the high impedance or power-off state, V_O ...	-0.3 V to $V_{DD} + 0.3 V$
Continuous output current, I_O ($V_O = 0$ to V_{DD})	-25 mA to 25 mA
Continuous current through V_{DD} or GND	-40 mA to 40 mA
Analog output current range, I_O	-25 mA to 25 mA
Maximum light exposure at 638 nm	5 mJ/cm ²
Operating free-air temperature range, T_A	-25°C to 85°C
Storage temperature range, T_{stg}	-25°C to 85°C
Lead temperature 1,6 mm (1/16 inch) from case for 10 seconds	260°C

† Stresses beyond those listed under “Absolute Maximum Ratings” may cause permanent damage to the device. These are stress ratings only, and functional operation of the device at these or any other conditions beyond those indicated under “Recommended Operating Conditions” is not implied. Exposure to absolute-maximum-rated conditions for extended periods may affect device reliability.

Recommended Operating Conditions

	MIN	NOM	MAX	UNIT
Supply voltage, V_{DD}	3	5	5.5	V
Input voltage, V_I	0		V_{DD}	V
High-level input voltage, V_{IH}	$V_{DD} \times 0.7$		V_{DD}	V
Low-level input voltage, V_{IL}	0		$V_{DD} \times 0.3$	V
Wavelength of light source, λ	400		1100	nm
Clock frequency, f_{clock}	5		8000	kHz
Sensor integration time, Serial, t_{int} (see Note 1)	0.20975		100	ms
Sensor integration time, Parallel, t_{int} (see Note 1)	0.11375		100	ms
Setup time, serial input, $t_{su(SI)}$	20			ns
Hold time, serial input, $t_h(SI)$ (see Note 2)	0			ns
Operating free-air temperature, T_A	0		70	°C
Load capacitance, C_L			330	pF
Load resistance, R_L	300			Ω

NOTES: 1. Integration time is calculated as follows:

$$t_{int(min)} = (1536 - 18) \times \text{clock period} + 20 \mu\text{s}$$

where 1536 is the number of pixels in series, 18 is the required logic setup clocks, and 20 μs is the pixel charge transfer time (t_{qt})

2. SI must go low before the rising edge of the next clock pulse.

TSL1412S

1536 × 1 LINEAR SENSOR ARRAY WITH HOLD

TAOS045F – APRIL 2007

Electrical Characteristics at $f_{\text{clock}} = 1 \text{ MHz}$, $V_{\text{DD}} = 5 \text{ V}$, $T_{\text{A}} = 25^{\circ}\text{C}$, $\lambda_{\text{p}} = 640 \text{ nm}$, $t_{\text{int}} = 5 \text{ ms}$, $R_{\text{L}} = 330 \Omega$, $E_{\text{e}} = 12.5 \mu\text{W}/\text{cm}^2$ (unless otherwise noted) (see Note 3)

PARAMETER		TEST CONDITIONS	MIN	TYP	MAX	UNIT
V_{out}	Analog output voltage (white, average over 1280 pixels)	See Note 4	1.6	2	2.4	V
V_{drk}	Analog output voltage (dark, average over 1280 pixels)	$E_{\text{e}} = 0$	0	0.1	0.3	V
PRNU	Pixel response nonuniformity	See Note 5			±20%	
	Nonlinearity of analog output voltage	See Note 6		±0.4%		
	Output noise voltage	See Note 7		1		mVrms
R_{e}	Responsivity	See Note 8	20	30	38	V/ ($\mu\text{J}/\text{cm}^2$)
V_{sat}	Analog output saturation voltage	$V_{\text{DD}} = 5 \text{ V}$, $R_{\text{L}} = 330 \Omega$	4.5	4.8		V
		$V_{\text{DD}} = 3 \text{ V}$, $R_{\text{L}} = 330 \Omega$	2.5	2.8		
SE	Saturation exposure	$V_{\text{DD}} = 5 \text{ V}$, See Note 9		155		nJ/cm ²
		$V_{\text{DD}} = 3 \text{ V}$, See Note 9		90		
DSNU	Dark signal nonuniformity	All pixels, $E_{\text{e}} = 0$, See Note 10		0.05	0.15	V
IL	Image lag	See Note 11		0.5%		
I_{DD}	Supply current	$V_{\text{DD}} = 5 \text{ V}$, $E_{\text{e}} = 0$		40	55	mA
		$V_{\text{DD}} = 3 \text{ V}$, $E_{\text{e}} = 0$		30	45	
V_{IH}	High-level input voltage		2			V
V_{IL}	Low-level input voltage				0.8	V
I_{IH}	High-level input current	$V_{\text{I}} = V_{\text{DD}}$			10	μA
I_{IL}	Low-level input current	$V_{\text{I}} = 0$			10	μA
C_{i}	Input capacitance, SI			25		pF
C_{i}	Input capacitance, CLK			25		pF

- NOTES: 3. All measurements made with a 0.1 μF capacitor connected between V_{DD} and ground.
4. The array is uniformly illuminated with a diffused LED source having a peak wavelength of 640 nm.
5. PRNU is the maximum difference between the voltage from any single pixel and the average output voltage from all pixels of the device under test when the array is uniformly illuminated at the white irradiance level. PRNU includes DSNU.
6. Nonlinearity is defined as the maximum deviation from a best-fit straight line over the dark-to-white irradiance levels, as a percent of analog output voltage (white).
7. RMS noise is the standard deviation of a single-pixel output under constant illumination as observed over a 5-second period.
8. $R_{\text{e}(\text{min})} = [V_{\text{out}(\text{min})} - V_{\text{drk}(\text{max})}] \div (E_{\text{e}} \times t_{\text{int}})$
9. $\text{SE}(\text{min}) = [V_{\text{sat}(\text{min})} - V_{\text{drk}(\text{min})}] \times (E_{\text{e}} \times t_{\text{int}}) \div [V_{\text{out}(\text{max})} - V_{\text{drk}(\text{min})}]$
10. DSNU is the difference between the maximum and minimum output voltage for all pixels in the absence of illumination.
11. Image lag is a residual signal left in a pixel from a previous exposure. It is defined as a percent of white-level signal remaining after a pixel is exposed to a white condition followed by a dark condition:

$$\text{IL} = \frac{V_{\text{out(IL)}} - V_{\text{drk}}}{V_{\text{out(white)}} - V_{\text{drk}}} \times 100$$

Timing Requirements (see Figure 1 and Figure 2)

		MIN	NOM	MAX	UNIT
$t_{\text{su(SI)}}$	Setup time, serial input (see Note 12)	20			ns
$t_{\text{h(SI)}}$	Hold time, serial input (see Note 12 and Note 13)	0			ns
$t_{\text{pd(SO)}}$	Propagation delay time, SO		50		ns
t_{w}	Pulse duration, clock high or low	50			ns
t_{r} , t_{f}	Input transition (rise and fall) time	0		500	ns
t_{qt}	Pixel charge transfer time	20			μs

- NOTES: 12. Input pulses have the following characteristics: $t_{\text{r}} = 6 \text{ ns}$, $t_{\text{f}} = 6 \text{ ns}$.
13. SI must go low before the rising edge of the next clock pulse.

Dynamic Characteristics over recommended ranges of supply voltage and operating free-air temperature (see Figures 7 and 8)

PARAMETER	TEST CONDITIONS	MIN	TYP	MAX	UNIT
t_s Analog output settling time to $\pm 1\%$	$R_L = 330 \Omega, C_L = 50 \text{ pF}$		120		ns
$t_{pd(SO)}$ Propagation delay time, SO1, SO2			50		ns

TYPICAL CHARACTERISTICS

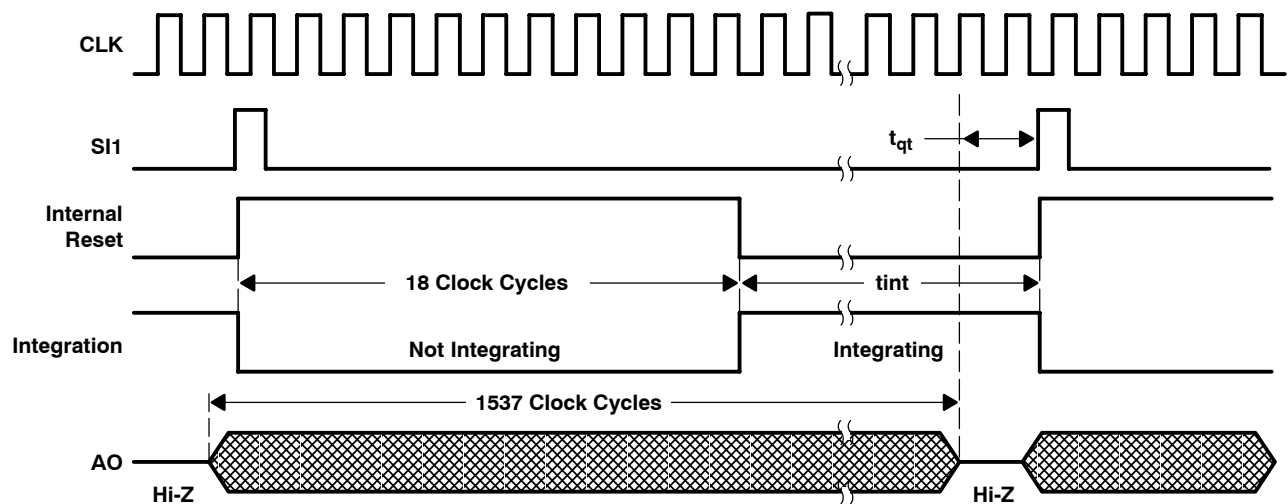

Figure 1. Timing Waveforms (serial connection)

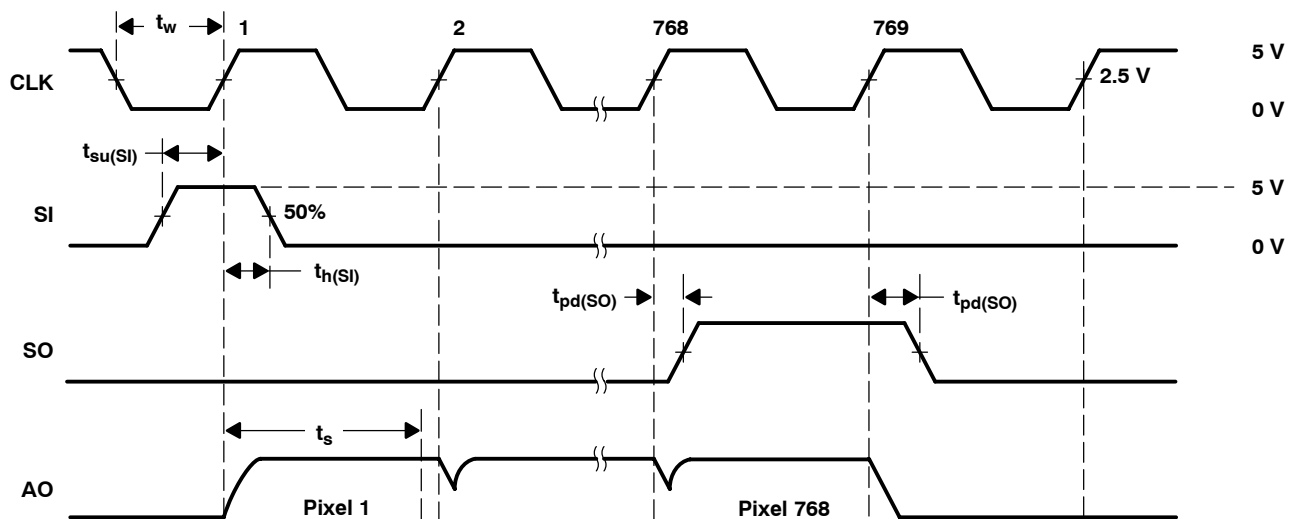

Figure 2. Operational Waveforms (Each Section)

TSL1412S

1536 × 1 LINEAR SENSOR ARRAY WITH HOLD

TAOS045F – APRIL 2007

TYPICAL CHARACTERISTICS

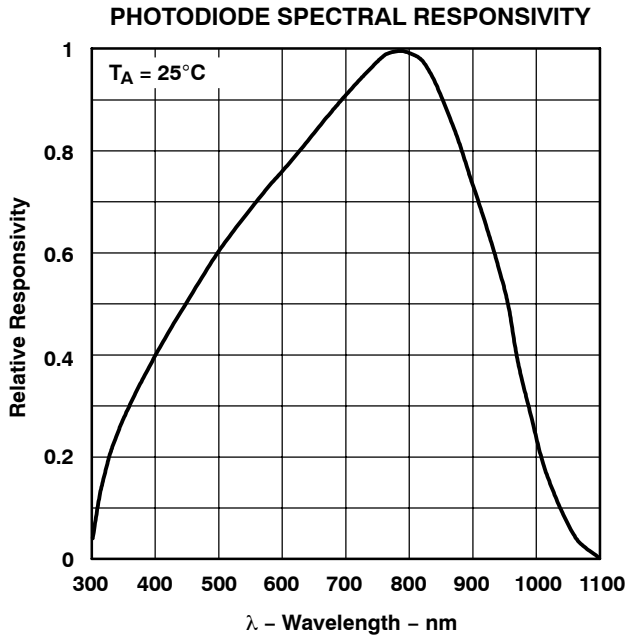

Figure 3

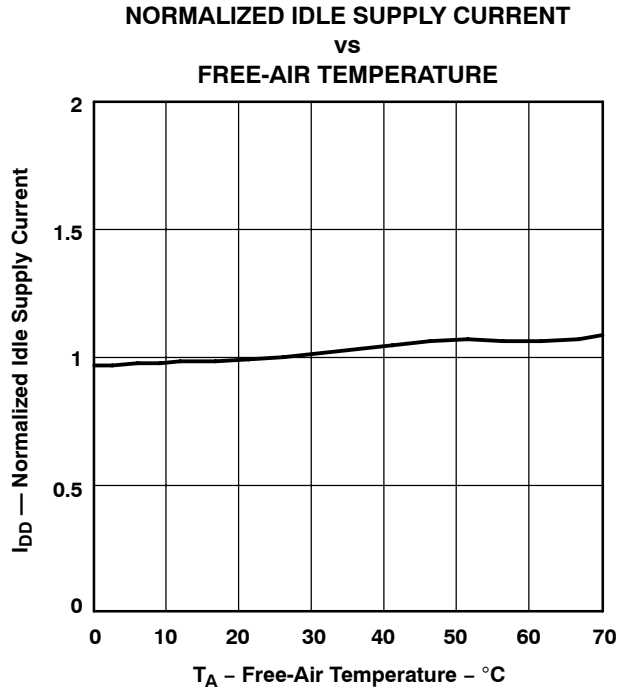

Figure 4

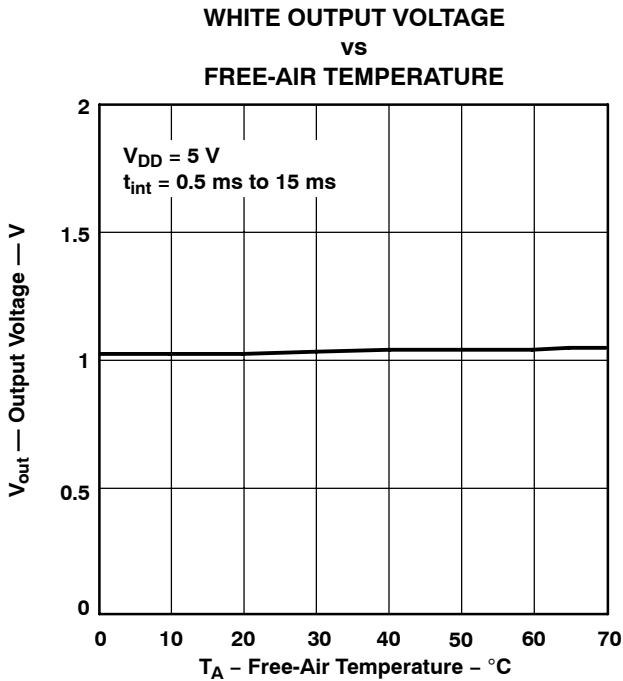

Figure 5

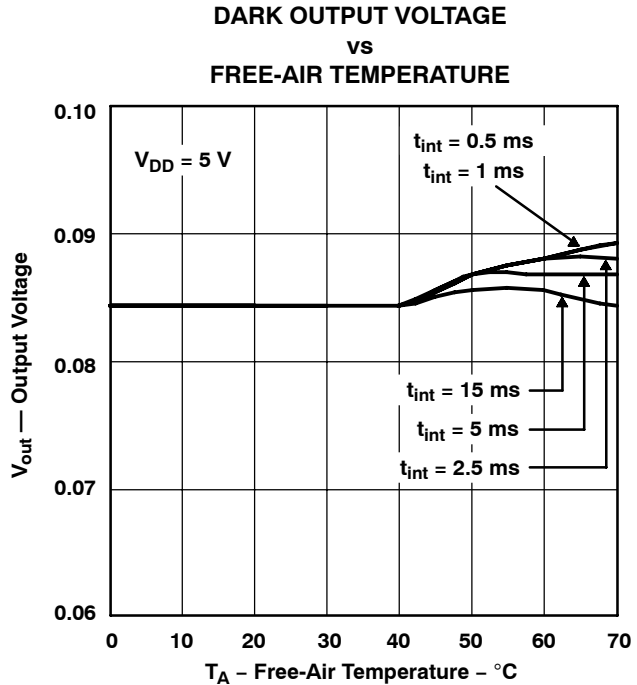

Figure 6

TYPICAL CHARACTERISTICS

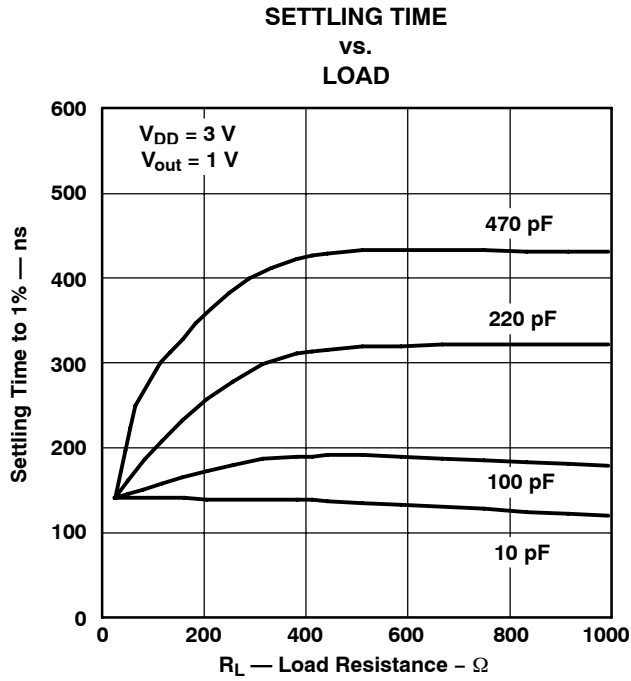

Figure 7

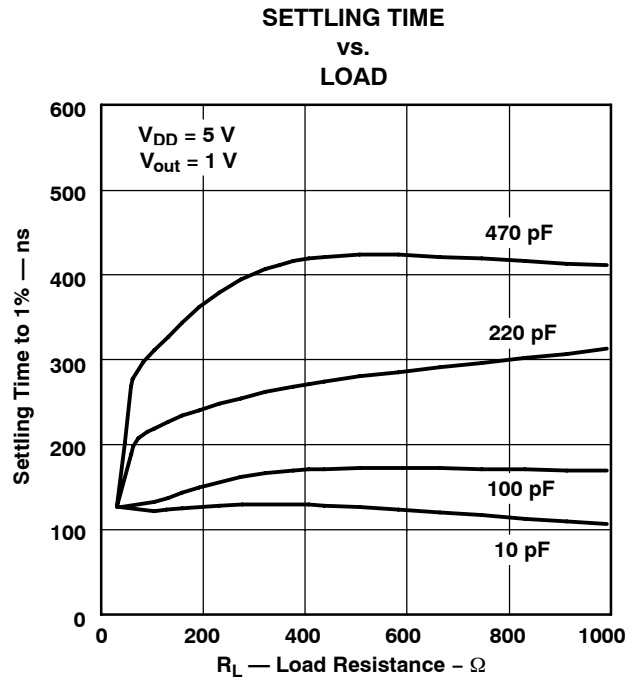

Figure 8

APPLICATION INFORMATION

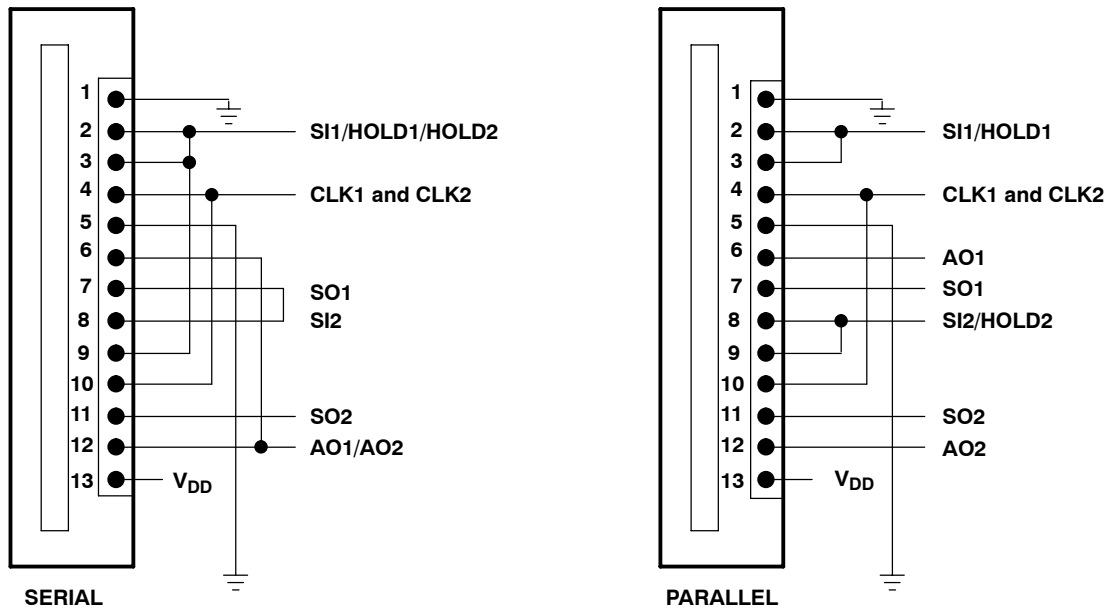

Figure 9. Operational Connections

TSL1412S

1536 × 1 LINEAR SENSOR ARRAY WITH HOLD

TAOS045F – APRIL 2007

APPLICATION INFORMATION

Integration Time

The integration time of the linear array is the period during which light is sampled and charge accumulates on each pixel's integrating capacitor. The flexibility to adjust the integration period is a powerful and useful feature of the TAOS TSL14xx linear array family. By changing the integration time, a desired output voltage can be obtained on the output pin while avoiding saturation for a wide range of light levels.

The integration time is the time between the SI (Start Integration) positive pulse and the HOLD positive pulse minus the 18 setup clocks. The TSL14xx linear array is normally configured with the SI and HOLD pins tied together. This configuration will be assumed unless otherwise noted. Sending a high pulse to SI (observing timing rules for setup and hold to clock edge) starts a new cycle of pixel output and integration setup. However, a minimum of $(n+1)$ clocks, where n is the number of pixels, must occur before the next high pulse is applied to SI. It is not necessary to send SI immediately on/after the $(n+1)$ clocks. A wait time adding up to a maximum total of 100 ms between SI pulses can be added to increase the integration time creating a higher output voltage in low light applications.

Each pixel of the linear array consists of a light-sensitive photodiode. The photodiode converts light intensity to a voltage. The voltage is sampled on the Sampling Capacitor by closing switch S2 (position 1) (see the Functional Block Diagram on page 1). Logic controls the resetting of the Integrating Capacitor to zero by closing switch S1 (position 2).

At SI input, all of the pixel voltages are simultaneously scanned and held by moving S2 to position 2 for all pixels. During this event, S2 for pixel 1 is in position 3. This makes the voltage of pixel 1 available on the analog output. On the next clock, S2 for pixel 1 is put into position 2 and S2 for pixel 2 is put into position 3 so that the voltage of pixel 2 is available on the output.

Following the SI pulse and the next 17 clocks after the SI pulse is applied, the S1 switch for all pixels remains in position 2 to reset (zero out) the integrating capacitor so that it is ready to begin the next integration cycle. On the rising edge of the 19th clock, the S1 switch for all the pixels is put into position 1 and all of the pixels begin a new integration cycle.

The first 18 pixel voltages are output during the time the integrating capacitor is being reset. On the 19th clock following an SI pulse, pixels 1 through 18 have switch S2 in position 1 so that the sampling capacitor can begin storing charge. For the period from the 19th clock through the n^{th} clock, S2 is put into position 3 to read the output voltage during the n^{th} clock. On the next clock the previous pixel S2 switch is put into position 1 to start sampling the integrating capacitor voltage. For example, S2 for pixel 19 moves to position 1 on the 20th clock. On the $n+1$ clock, the S2 switch for the last (n^{th}) pixel is put into position 1 and the output goes to a high-impedance state.

If a SI was initiated on the $n+1$ clock, there would be no time for the sampling capacitor of pixel n to charge to the voltage level of the integrating capacitor. The minimum time needed to guarantee the sampling capacitor for pixel n will charge to the voltage level of the integrating capacitor is the charge transfer time of 20 μs . Therefore, after $n+1$ clocks, an extra 20 μs wait must occur before the next SI pulse to start a new integration and output cycle.

The minimum integration time for any given array is determined by time required to clock out all the pixels in the array and the time to discharge the pixels. The time required to discharge the pixels is a constant. Therefore, the minimum integration period is simply a function of the clock frequency and the number of pixels in the array. A slower clock speed increases the minimum integration time and reduces the maximum light level for saturation on the output. The minimum integration time shown in this data sheet is based on the maximum clock frequency of 8 MHz.

APPLICATION INFORMATION

The minimum integration time can be calculated from the equation:

$$T_{int(min)} = \left(\frac{1}{\text{maximum clock frequency}} \right) \times (n - 18) \text{ pixels} + 20\mu\text{s}$$

where:

n is the number of pixels

In the case of the TSL1412S with the maximum clock frequency of 8 MHz, the minimum integration time would be:

$$T_{int(min)} = 0.125\mu\text{s} \times (768 - 18) + 20\mu\text{s} = 113.75\mu\text{s}$$

It is good practice on initial power up to run the clock ($n+1$) times after the first SI pulse to clock out indeterminate data from power up. After that, the SI pulse is valid from the time following ($n+1$) clocks. The output will go into a high-impedance state after the $n+1$ high clock edge. It is good practice to leave the clock in a low state when inactive because the SI pulse required to start a new cycle is a low-to-high transition.

The integration time chosen is valid as long as it falls in the range between the minimum and maximum limits for integration time. If the amount of light incident on the array during a given integration period produces a saturated output (Max Voltage output), then the data is not accurate. If this occurs, the integration period should be reduced until the analog output voltage for each pixel falls below the saturation level. The goal of reducing the period of time the light sampling window is active is to lower the output voltage level to prevent saturation. However, the integration time must still be greater than or equal to the minimum integration period.

If the light intensity produces an output below desired signal levels, the output voltage level can be increased by increasing the integration period provided that the maximum integration time is not exceeded. The maximum integration time is limited by the length of time the integrating capacitors on the pixels can hold their accumulated charge. The maximum integration time should not exceed 100 ms for accurate measurements.

It should be noted that the data from the light sampled during one integration period is made available on the analog output during the next integration period and is clocked out sequentially at a rate of one pixel per clock period. In other words, at any given time, two groups of data are being handled by the linear array: the previous measured light data is clocked out as the next light sample is being integrated.

Although the linear array is capable of running over a wide range of operating frequencies up to a maximum of 8 MHz, the speed of the A/D converter used in the application is likely to be the limiter for the maximum clock frequency. The voltage output is available for the whole period of the clock, so the setup and hold times required for the analog-to-digital conversion must be less than the clock period.

TSL1412S

1536 × 1 LINEAR SENSOR ARRAY WITH HOLD

TAOS045F – APRIL 2007

MECHANICAL INFORMATION

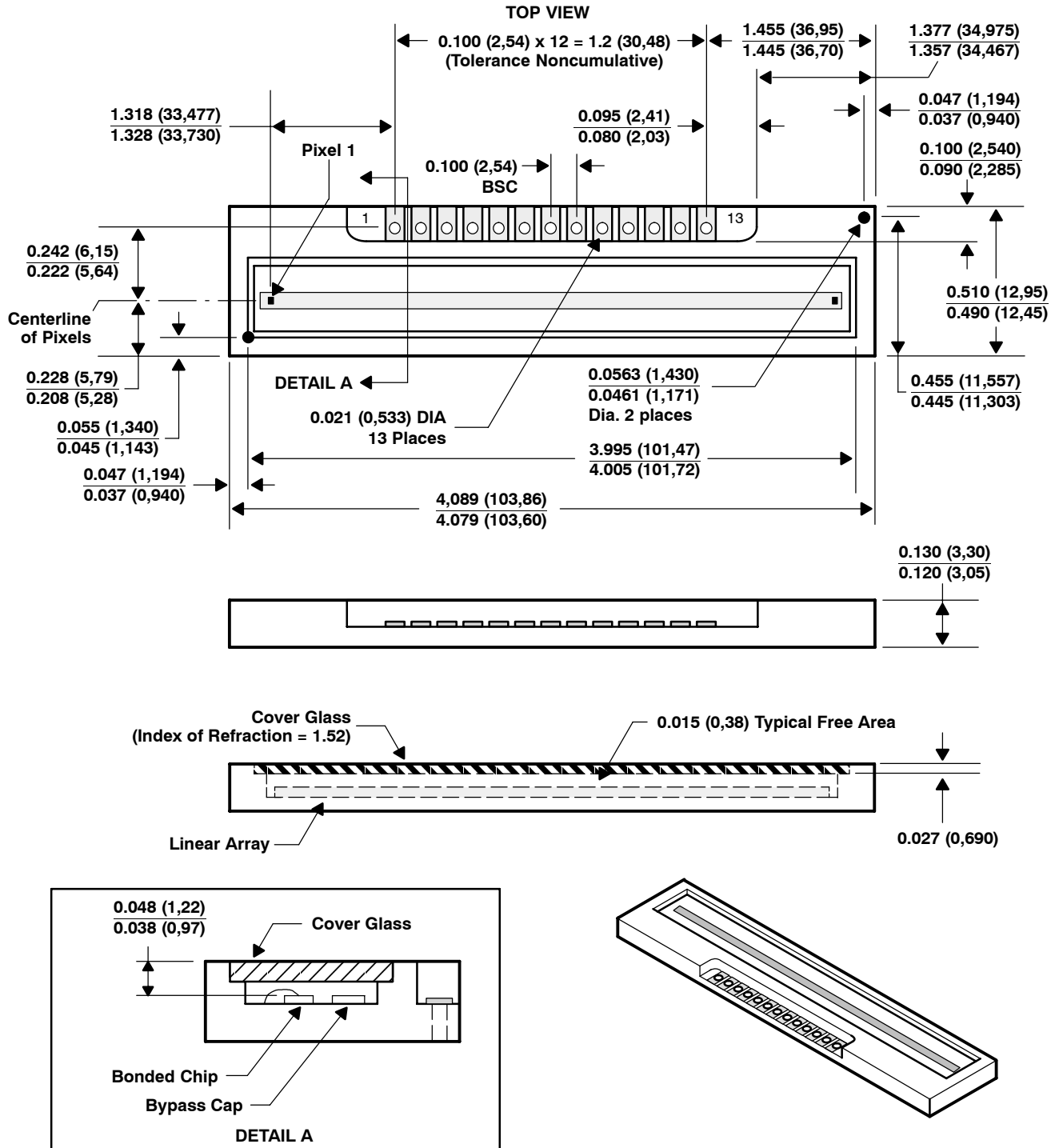

- NOTES: A. All linear dimensions are in inches (millimeters).
 B. Cover glass index of refraction is 1.52.
 C. The gap between the individual sensor dies in the array is 57 μm typical (51 μm minimum and 75 μm maximum).
 D. This drawing is subject to change without notice.

Figure 10. TSL1412S Mechanical Specifications

MECHANICAL INFORMATION

THEORETICAL PIXEL LAYOUT FOR IDEAL CONTINUOUS DIE

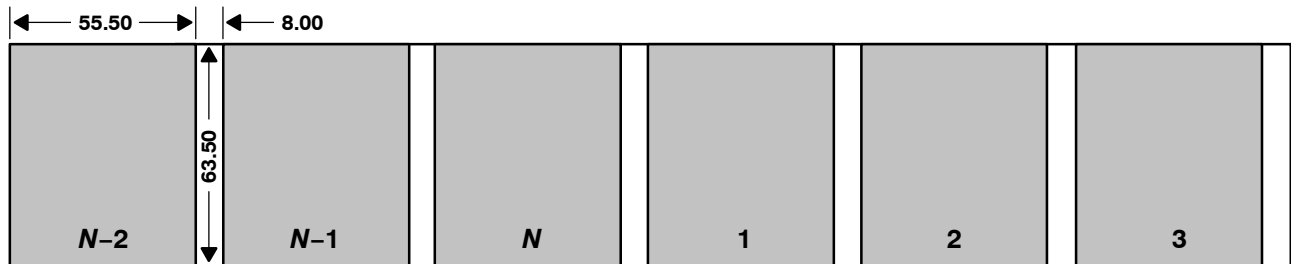

ACTUAL MULTI-DIE PIXEL LAYOUT FOR DIE-TO-DIE EDGE JOINING

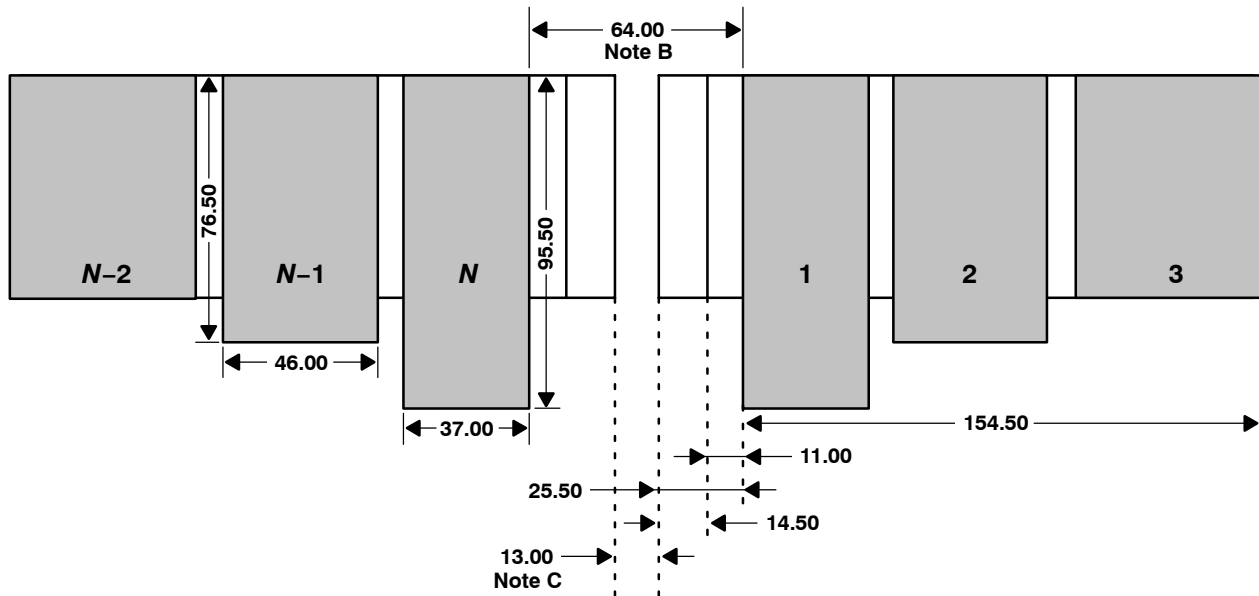

- NOTES: A. All linear dimensions are in micrometers.
 B. Spacing between outside pixels of adjacent die is typical.
 C. Die-to-die spacing.
 D. This drawing is subject to change without notice.

Figure 11. Edge Pixel Layout Dimensions

TSL1412S

1536 × 1 LINEAR SENSOR ARRAY WITH HOLD

TAOS045F – APRIL 2007

PRODUCTION DATA — information in this document is current at publication date. Products conform to specifications in accordance with the terms of Texas Advanced Optoelectronic Solutions, Inc. standard warranty. Production processing does not necessarily include testing of all parameters.

NOTICE

Texas Advanced Optoelectronic Solutions, Inc. (TAOS) reserves the right to make changes to the products contained in this document to improve performance or for any other purpose, or to discontinue them without notice. Customers are advised to contact TAOS to obtain the latest product information before placing orders or designing TAOS products into systems.

TAOS assumes no responsibility for the use of any products or circuits described in this document or customer product design, conveys no license, either expressed or implied, under any patent or other right, and makes no representation that the circuits are free of patent infringement. TAOS further makes no claim as to the suitability of its products for any particular purpose, nor does TAOS assume any liability arising out of the use of any product or circuit, and specifically disclaims any and all liability, including without limitation consequential or incidental damages.

TEXAS ADVANCED OPTOELECTRONIC SOLUTIONS, INC. PRODUCTS ARE NOT DESIGNED OR INTENDED FOR USE IN CRITICAL APPLICATIONS IN WHICH THE FAILURE OR MALFUNCTION OF THE TAOS PRODUCT MAY RESULT IN PERSONAL INJURY OR DEATH. USE OF TAOS PRODUCTS IN LIFE SUPPORT SYSTEMS IS EXPRESSLY UNAUTHORIZED AND ANY SUCH USE BY A CUSTOMER IS COMPLETELY AT THE CUSTOMER'S RISK.

LUMENOLOGY, TAOS, the TAOS logo, and Texas Advanced Optoelectronic Solutions are registered trademarks of Texas Advanced Optoelectronic Solutions Incorporated.