

PAGE 1/2

ISSUE 16-04-20

SERIE : SPnT

PART NUMBER : R574803610

RF CHARACTERISTICS

Number of ways : **6**
 Frequency range : **0 - 40 GHz**
 Impedance : **50 Ohms**

Frequency (GHz)	DC - 6	6 - 12.4	12.4 - 18	18 - 26.5	26.5 - 40
VSWR max	1.30	1.40	1.50	1.70	2.20
Insertion loss max	0.20 dB	0.40 dB	0.50 dB	0.70 dB	1.10 dB
Isolation min	70 dB	60 dB	60 dB	55 dB	50 dB
Average power (*)	40 W	30 W	25 W	15 W	5 W

TERMINATION IMPEDANCE : **50 Ohms**
 TERM. AVG. POWER AT 25° C : **1 W per termination / 3 W total power**

ELECTRICAL CHARACTERISTICS

Actuator : **NORMALLY OPEN**
 Nominal current ** : **102 mA**
 Actuator voltage (Vcc) : **28V (24 to 30V) / POSITIVE COMMON**
 Terminals : **solder pins (250°C max. / 30 sec.)**

MECHANICAL CHARACTERISTICS

Connectors : **SMA 2.9 female per MIL-C 39012**
 Life : **2 million cycles per position**
 Switching Time*** : **< 15 ms**
 Construction : **Splashproof**
 Weight : **< 250 g**

ENVIRONMENTAL CHARACTERISTICS

Operating temperature range : **-40°C to +85°C**
 Storage temperature range : **-55°C to +85°C**

(* Average power at 25°C per RF Path)

(** At 25° C ±10%)

(*** Nominal voltage ; 25° C)



PAGE 2/2

ISSUE 16-04-20

SERIE : SPnT

PART NUMBER : R574803610

DRAWING

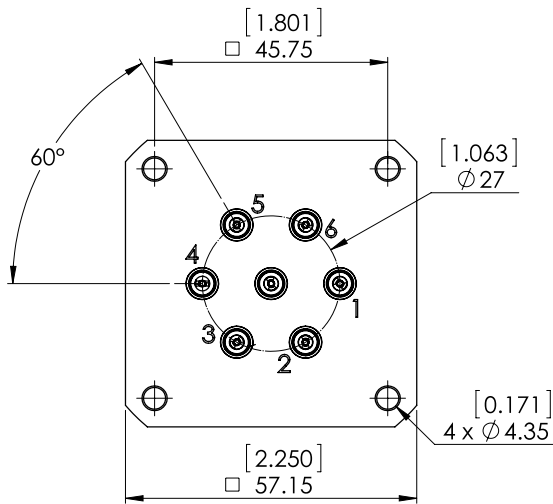

Voltage	RF Continuity
+C -1	IN ↔ 1
+C -2	IN ↔ 2
+C -3	IN ↔ 3
+C -4	IN ↔ 4
+C -5	IN ↔ 5
+C -6	IN ↔ 6

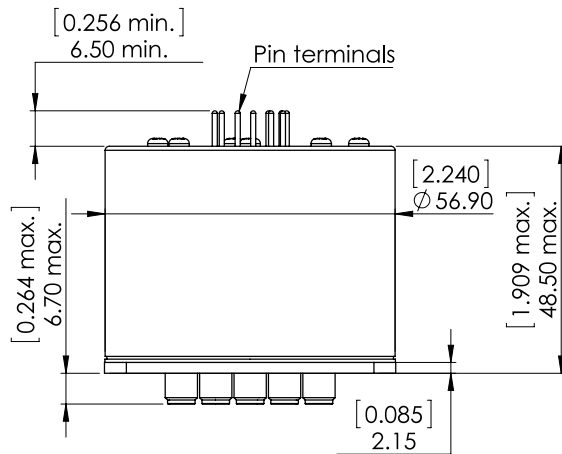

General tolerances : ±0,5 mm [0,02 in]

LABEL

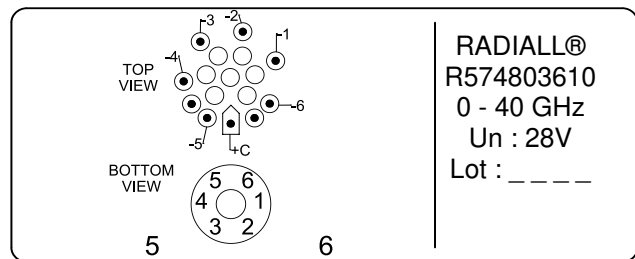

SCHEMATIC DIAGRAM

