



SPECIFICATION SHEET

SPECIFICATION SHEET NO.	Q0201- XV24M00000S409
DATE	Feb. 01, 2023
REVISION	A0
DESCRIPTION	MHz SMD Crystal, Seam Seal, L2.0*W1.6*H0.5mm, 4 pads, CM21 series 24.0000MHz, Tolerance +/-10ppm, Load Capacitor 9pF, Frequency stability +/-30ppm @Operating Temp. Range -40°C ~+85°C, ESR 100 ohm Max, Reflow Profile Condition 260 °C Max. Tape/Reel, 3000pcs/Reel RoHS/RoHS III compliant
CUSTOMER	
CUSTOMER PART NUMBER	
CROSS REF. PART NUMBER	
ORIGINAL PART NUMBER	TGS CM21-24M0A10-9-30-40-100TLF
PART CODE	XV24M00000S409

VENDOR APPROVE			
Issued/Checked/Approved			
DATE: Feb. 01, 2023			

CUSTOMER APPROVE	
DATE:	

2/1/2023

SMD CRYSTAL 2016 TYPE 4 PADS

MAIN FEATURE

- SMD Crystal, Seam Seal, L2.0*W1.6*H0.5mm, 4 pads
- Low cost, High precision, High frequency stability
- Reflow Profile Condition 260 °C Max.
- Cross more competitors part
- RoHS/RoHS III compliant



APPLICATION

- Bluetooth, wireless communication set
- Communication Electronics

PART CODE GUIDE

RFQ
Request For Quotation

XV	24M00000	S	409
1	2	3	4

- 1) XV: Part family Code for SMD Crystal, Seam Seal, L2.0*W1.6*H0.5mm, 4 pads (CM21 Series)
- 2) 24M00000: Frequency range code for 24.0000MHz
- 3) S: SMD type, Package Tape/Reel, 3000pcs/Reel
- 4) 409: Specification code for original part No.: **TGS CM21-24M0A10-9-30-40-100TLF**

DIMENSION (Unit: mm, Tol. +/-0.15mm)

Image for reference

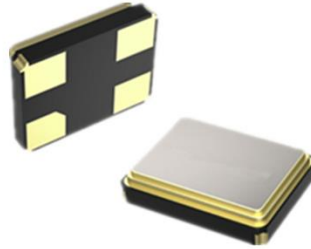

CM21

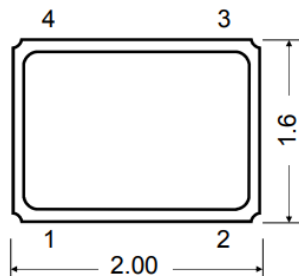

Marking
Standard

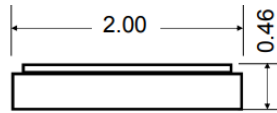

Connection
#1 Crystal
#2 Ground
#3 Crystal
#4 Ground

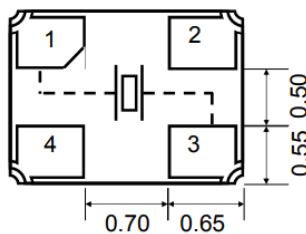

Recommend Pad Layout

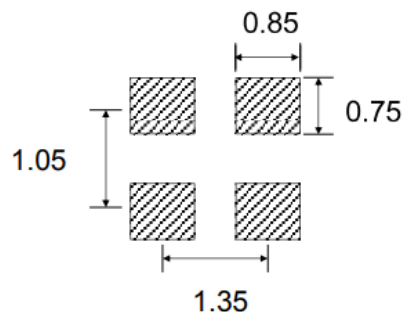

SMD CRYSTAL 2016 TYPE 4 PADS
ELECTRICAL PARAMETERS

Parameter	Part No. Symbol	Units	Value			Condition
			Min.	Typical	Max.	
Original Manufacturer	TGS	TGS Crystals				
Holder Type	CM21	SMD Crystal, Seam Seal, L2.0*W1.6*H0.5mm, 4 pads				
Frequency Range	24M0	MHz	24.000			
Mode of Oscillation	A	Fundamental				
Frequency Tolerance	10	ppm	-10		+10	@25°C
Load Capacitance	-9	pF	9			
Stability over Operation Temperature	-30	ppm	-30		+30	
Operation Temperature	-40	°C	-40		+85	
Storage Temperature		°C	-55		+125	
Equivalent Series Resistance (ESR)	-100	Ω			100	
Drive Level		μW			100	
Shunt Capacitance (C0)		pF	0		7.0	
Motional Capacitance (C1)		fF	N/A			
DLD2		Ω	N/A			
FLD2		ppm	N/A			
RDL2		Ω	N/A			
SPDB		dB	N/A			
Aging		ppm/year			±3	@1 st year
Insulation Resistance		MΩ	500			@100Vdc ± 15Vdc
Others	Package	T	Tape/Reel			
	RoHS Status	LF	RoHS III compliant			
	Add Value		N/A			
	Internal Control Code *		N/A			

Note: 1) Original Part Number: TGS CM21-24M0A10-9-30-40-100TLF

2) * Internal Control Code- 2 letter or digits; Blank: N/A

2/1/2023

SMD CRYSTAL 2016 TYPE 4 PADS

RELIABILITY

Test Items	Test Method And Conditions	Reference Documents
High Temperature High Humidity Storage	Temperature: 85°C±3°C Relative Humidity:85%RH Time: 96 Hours	JIS C5023
High Temperature Storage	Temperature: 125°C±3°C Time: 96 Hours.	MIL-STD-883E Method 1005.8
Low Temperature Storage	Temperature: -40°C±3°C Time: 96 Hours.	MIL-STD-883E Method 1013
Thermal Shock	Temperature 1: -55°C±5°C Temperature 2: 85°C±5 °C Temperature change between T1 and T2 5 min 10cycles maintain T1 and T2 for 30 minutes each cycle	MIL-STD-202F Method 107 Condition A
Resistance to Solder Heat	Solder Temperature: 260°C±5°C Time: 10±1 Seconds	MIL-STD-202F Method 210E
Solderability	The solder pot temperature is 245±5°C , dwell time 5±0.5sec	J-STD-002B
Drop Test	3 Times Free Fall from 50cm height table to 3cm thickness hard wood board	J-STD-002B
Mechanical Shock	Half sine wave,1000 G 3 Times for all 3 directions(X,Y Z)	MIL STD 202F Method 213B
Vibration	Frequency Range: 10Hz ~ 55Hz Amplitude: 0.75mm 2 Hours in each direction, total 6 Hours	MIL-STD-883E Method 2007.3
Leakage Test	Take measurements with a helium Leakage detector Leakage Rates≤1×10 ⁻³ Pa cm ³ /s	MIL-STD-883E

SUGGESTED REFLOW PROFILE (For Reference Only)



Profile Feature		Pb-Free Assembly
Average Ramp-up Rate (Ts Max to Tp)		3°C/second Max
Preheat	Temperature Min (Ts Min.)	125°C
	Temperature Max (Ts Max.)	200°C
	Time (ts Min. to ts Max.)	60 ~ 180 seconds
Time maintained above	Temperature (T_L)	217°C
	Time (t_L)	60 ~ 150 seconds
Peak/Classification Temperature (T_p)		260 °C
Time within 5°C of actual Peak Temperature (t_p)		20 ~ 40 seconds
Ramp-down rate		6 °C /Second Max.
Time 25 °C to Peak Temperature		8 minutes Max.
Suggest reflow times		3 Times Max.

TAPE/REEL (Unit: mm)

All Devices are packed in accordance with EIA standard RS-481-2 and specifications., 3000pcs/Reel

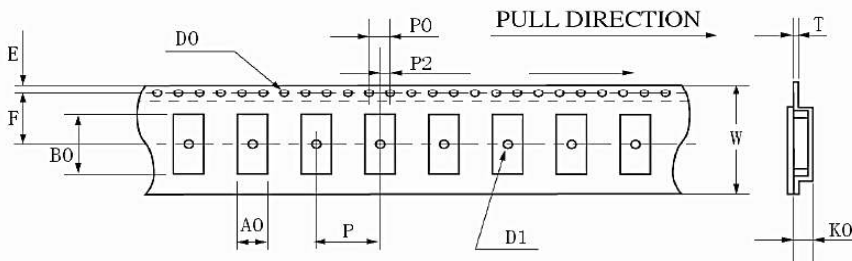

W	8.00+/-0.2
E	1.75+/-0.1
F	3.5+/-0.05
T	0.25+/-0.05
P	4.0+/-0.1
P0	4.0+/-0.1
P2	2.0+/-0.1
D0	Ø1.55+0.05
D1	Ø1.1+0.05
A0	1.2+/-0.1
K0	0.65+/-0.1
B0	2.2+/-0.1

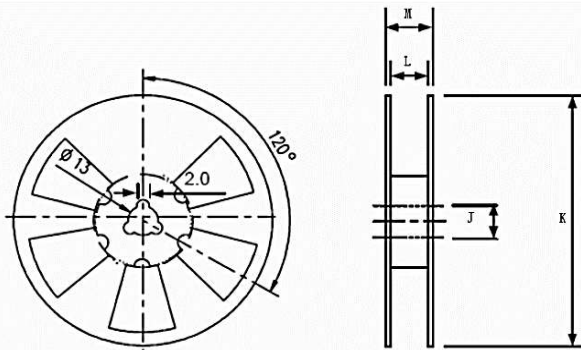

DIMENSIONS	J	K	L	M	pcs/Reel(unit:mm)
	13	178	8	11.5	Standard Reel Quality is 3,000pcs per reel

DISCLAIMER

NextGen Components, Inc. reserves the right to make changes to the product(s) and or information contained herein without notice. No liability is assumed as a result of their use or application. No rights under any patent accompany the sale of any such product(s) or information

2/1/2023