



Safety

Please read this manual carefully and follow its instructions. Improper use or failure to follow these instructions could result in serious injury, death or property damage. Operators should be instructed in the safe and proper use and maintenance of this product. Keep this manual for future reference.

The following safety precautions call attention to potentially dangerous conditions.

- | | |
|--|---|
| | WARNING: Warnings are used when hazards exist which could result in serious injury, death, or property damage, if proper precautions are not taken. |
| | CAUTION: Cautions are used as reminders of safety hazards, which could result in personal injury or property damage if proper precautions are not taken. |

Installation

- | | |
|--|--|
| | CAUTION: Instruct operators in the safe, proper use and maintenance. Keep this manual for future reference. |
| | WARNING: Failure to read, understand, and follow these instructions may result in personal injury or death. |

Mounting surface. (Provided by customer.) The system hanger brackets must be mounted in line on a continuous surface or series of supports that are on the same horizontal plane. The mounting surface must be structurally sound and designed in accordance with good engineering practices for the intended use.

Hanger brackets. Two or more hanger brackets should be used per 12 feet track section. The hanger brackets should be approximately 60 inches apart for 5200 series, 80 inches apart for 5400 series and located approximately 2-1/2 feet from the end of the track section. If more than two hanger brackets are used per track section, they may be spaced as desired. Do not tighten hanger brackets on the track until all track and joint brackets are in place. When the track sections and joint brackets are in place, tighten the compression screws on the hanger brackets. The screws should be tightened firmly against the track.

- | | |
|--|---|
| | CAUTION: Do not over tighten the compression screws. Make sure the track is not distorted. |
|--|---|

Track and joint brackets. Assemble all track sections into hanger brackets. Make sure that track ends are firmly together and joint brackets are centered over joints before tightening. Do not over tighten.

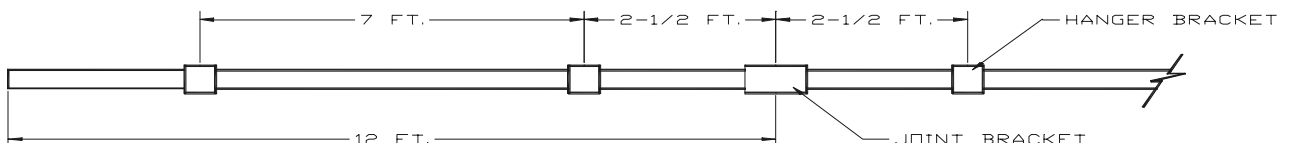

Pass a trolley back and forth through the joint to insure that the track ends have not been distorted and the trolley passes through smoothly. Tighten hanger brackets as described in paragraph 2 (hanger brackets).

Trolleys and end clamps. Tow--lead--trolley, intermediate trolleys and end clamp can now be assembled into the track. Secure the end clamp to the track by tightening the two bolts provided. The

clamp must be assembled with the trolley stop pointed toward the intermediate trolleys. An end stop should be located at the other end of the track to prevent any trolleys from falling out of the system.

Tow bar (provided by customer). The festoon system is moved along the track by means of a connection between the tow trolley and the moving hoist, or crane. This connection is made by extending a tow bar made of round bar or tube--not to exceed 1-1/8 inch diameter--from the moving equipment through the opening provided in the tow trolley. The tow bar should be positioned in the center of the opening and must be long enough to fully engage the trolley under all conditions. Excessive up and down movement--3/4 inch--of the tow bar should be avoided to prevent possible damage to the system.

NOTE: The tow bar should not be fastened in any way to the tow trolley.

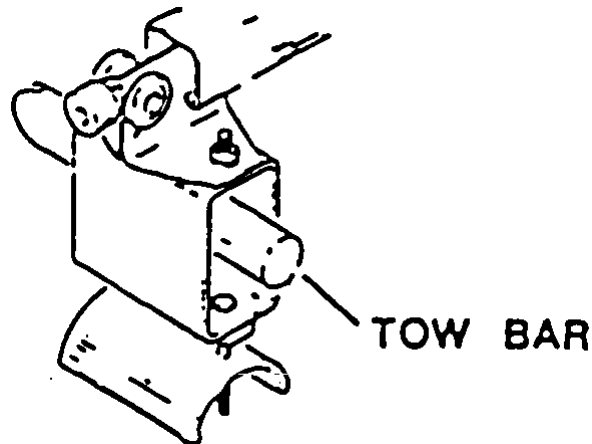

Cable installation

- a. The cable length provided consists of the working cable and that which is required for hook up--specified by customer--at each end.
- b. Measure the length required for hook up at the fixed end of the system and mark the cable using chalk or some other suitable method. To determine this length, you must find the working length and loop mark using a loop depth. To do this, **take the stroage added to the working travel and multiply it by 1.1, then divide that by the number of loops**. This gives you your loop mark. From this mark, measure the total working cable and make another mark. Divide the working distance into equal spaces numbering the same as the total number of trolleys, including the lead trolley, and make a mark at each space.
- c. Feed the cable through the clamps and secure it at the first mark to the fixed clamp, then at each consecutive clamp until it is clamped in the tow trolley at the last mark, with the remaining cable extending beyond for hook up. When clamping the cables at the trolleys, the cable marks should be located in the center of the cable saddle. The cable should be square with the saddle and the nuts tightened just enough to hold the cable firmly.
- d. When clamping multiple cables of different sizes, the wider cables should be placed on the bottom next to the saddle with the smaller cables on top.
- e. With multiple cables, it is desirable to use loop clamps (LO-58 or LO-90) to retain the cables in a neat, controlled package. For loops up to four feet, one clamp can be used at the bottom of the loop. For longer loops, use two clamps with one placed approximately half way down each side of the loop.
- f. Stagger the position of these clamps slightly so they do not bump each other when the loops come together.
- g. For best performance, you should follow the natural coil of the cable or hose when looping and clamping to the trolleys. Otherwise the cable or hose could bind and kink up.

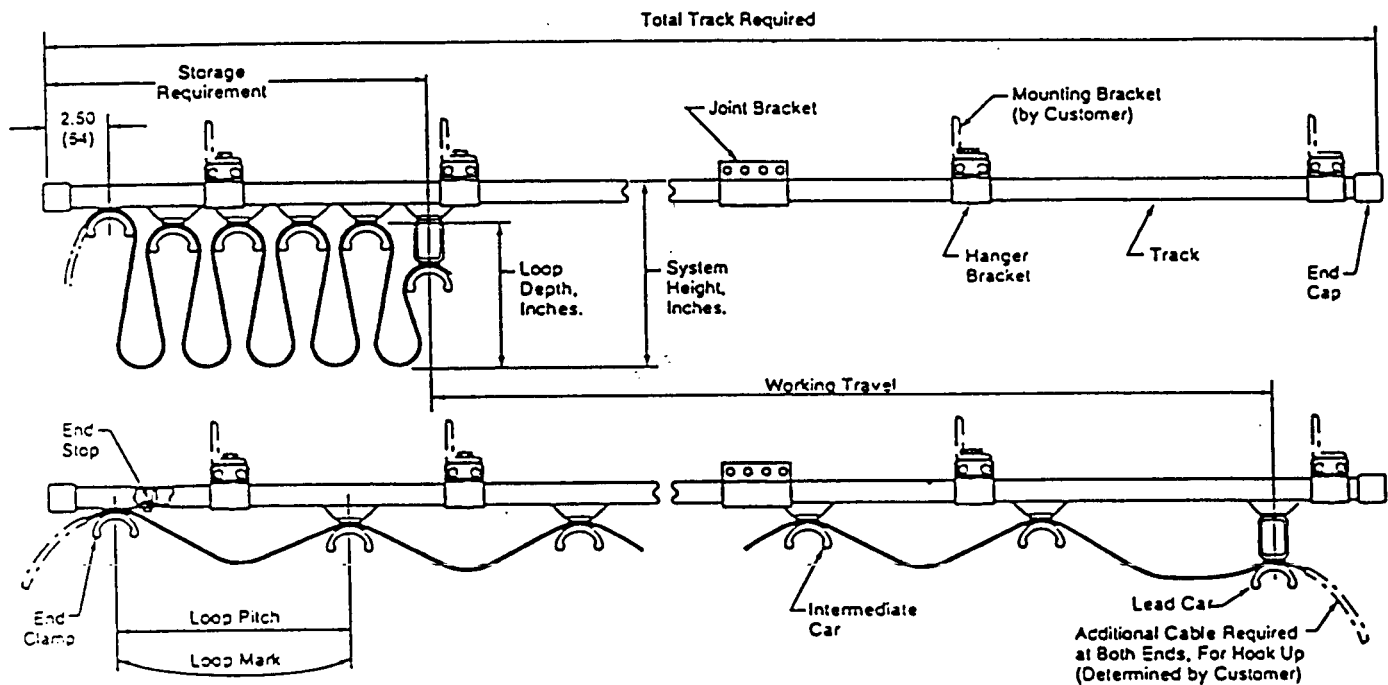

Intermediate Cars – 5200 Series Flat Cable

* "S" prefix indicates steel wheels and body nylon are standard

Model 5242-1
mfg 58862

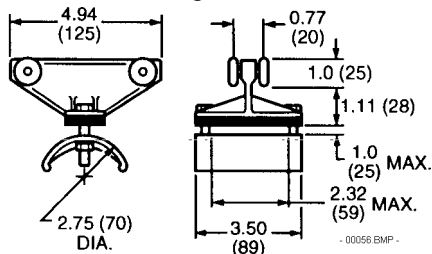

Model S5242-1*
mfg 59966

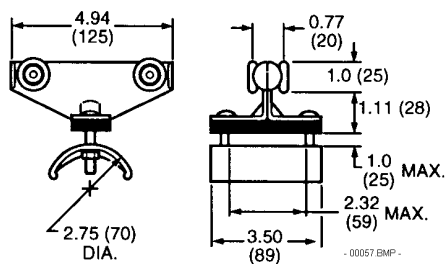

Model 5245-1
mfg 59931

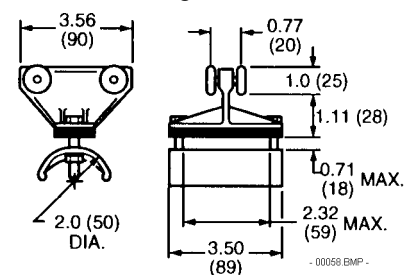

Lead Cars and End Clamps 5200 Series Flat

Model 5242-3
mfg 58872

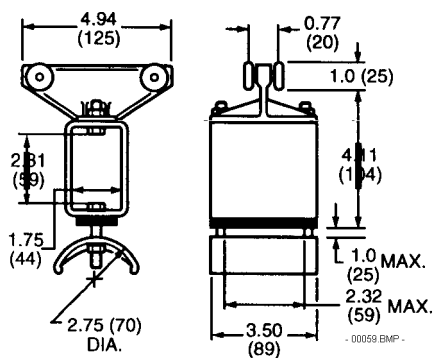

Model S5242-3
mfg 59927

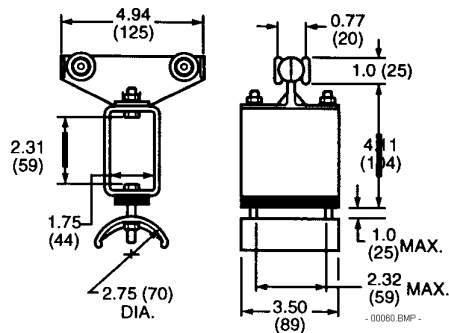

End Clamp
Model 5242-2
mfg 58852

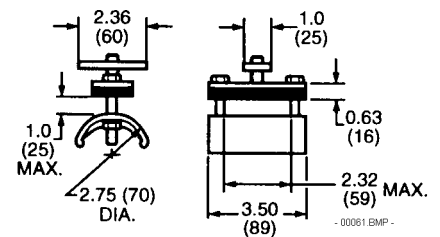

Other Parts

Track
 Model 5200-6 (6') mfg 58802
 Model 5200-12(12') mfg 58800

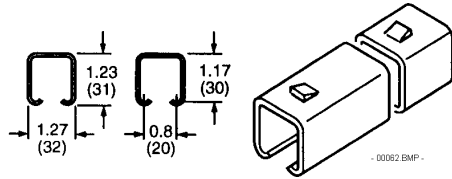

Hanger bracket
 Model 5200-HB
 mfg 58810

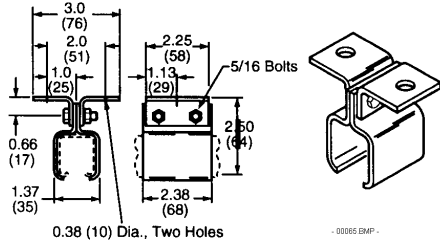

End stop
 Model 5200-ES
 mfg 59050

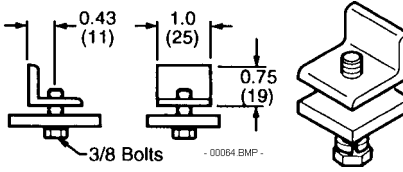

Joint bracket
 Model 5200-JB
 mfg 58828

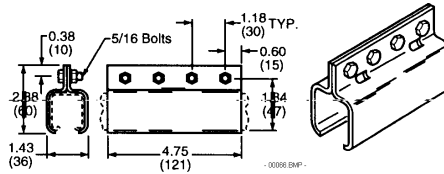

Intermediate Cars, End Clamps, & Lead Cars 5400 Series Round

Intermediate cars
 Model S5421-1, mfg 59948

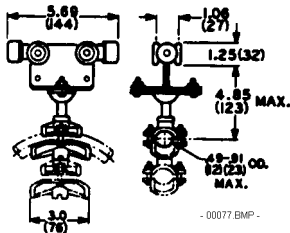

Model S5431-1, mfg 59949

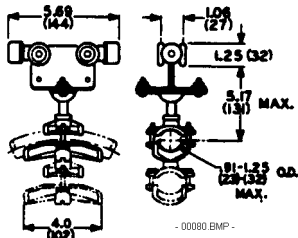

End clamp
 Model 5421-2, mfg 61028

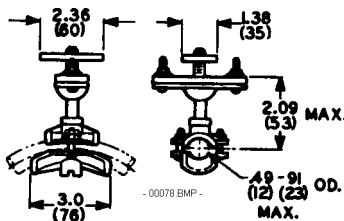

Model 5431-2, mfg 61029

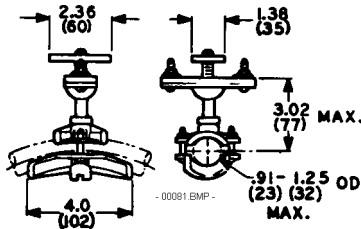

Lead cars
 Model S5421-3, mfg 59950

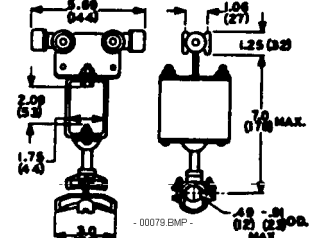

Model S5431-3, mfg 59951

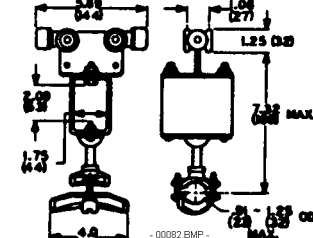

Extra Saddles
 Model 5122, mfg 58993
 for round cable or hose 0.49" - 0.91" OD

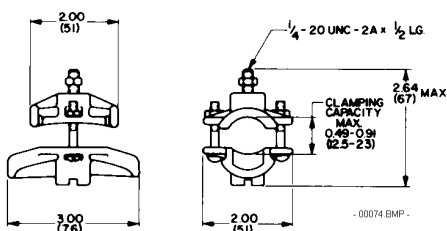

Extra Saddles
 Model 5132, mfg 58994
 for round cable or hose 0.91" - 1.25" OD

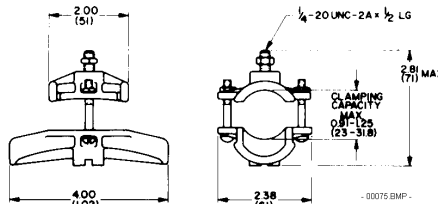

Track
 Model 5400-6(6'), mfg 58806
 Model 5400-12(12'), mfg 58804

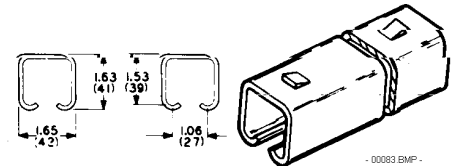

Joint bracket
Model 5400-JB, mfg 58829

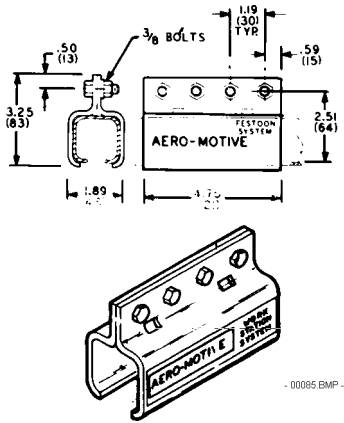

End stop
Model 5400-ES, mfg 59051

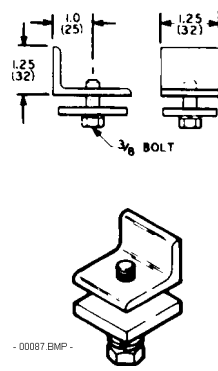

Hanger bracket
Model 5400-HB, mfg 58812

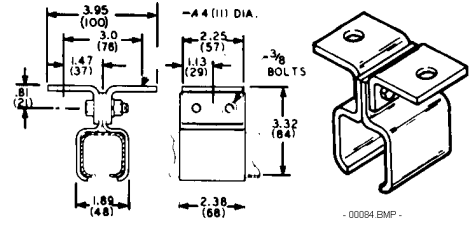

5400 Series Flat Cable Cars, End Clamps, & Lead Cars

Intermediate cars
Model 5410-1, mfg 59968

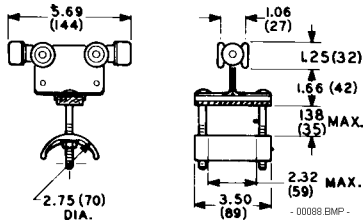

Model 5412-1, mfg 59969

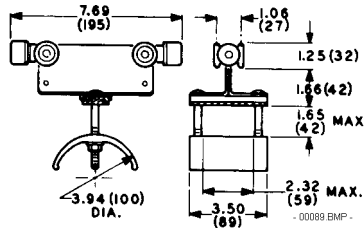

Model 5414-1, mfg 59970

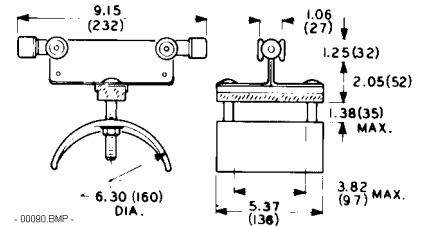

End clamps
Model 5410-2, mfg 58853

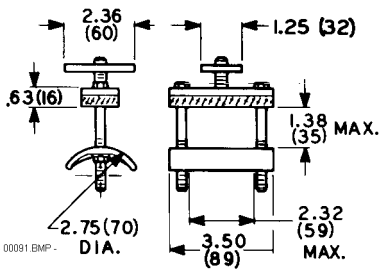

Model 5412-2, mfg 58854

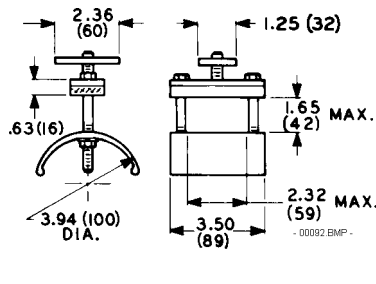

Model 5414-2, mfg 58855

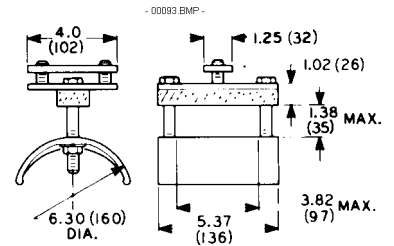

Lead cars
Model 5410-3, mfg 59978

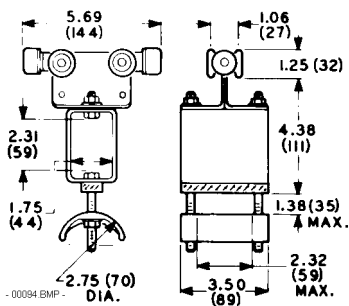

Model 5412-3, mfg 59979

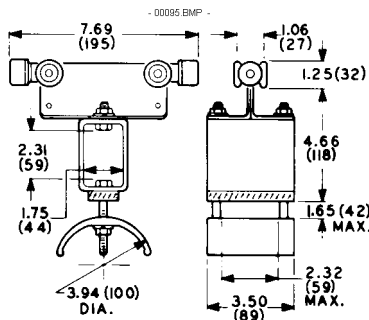

Model 5414-3, mfg 59980

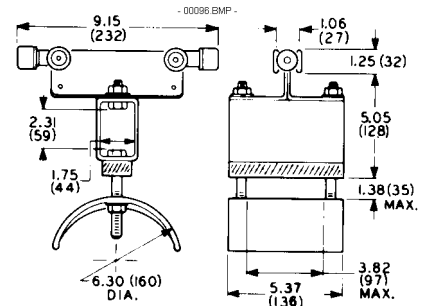

Hanger bracket
Model 5400-HB, mfg 58812

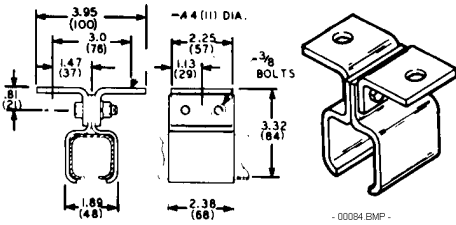

End stop
Model 5400-ES, mfg 59051

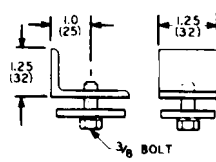

End cap
Model 5400-EC, mfg 58831

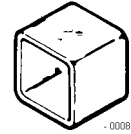
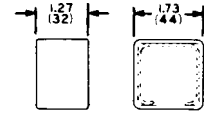

Intermediate Cars, Lead clamps, & End Cars 5200 Series Round Cable

Intermediate cars
Model 5221-1
mfg 61022

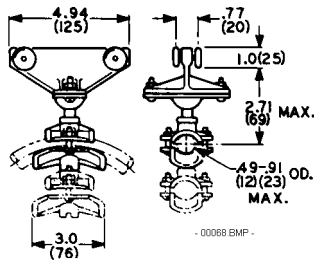

End clamps
Model 5221-2
mfg 61018

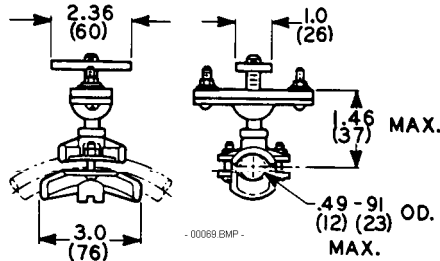

Lead cars
Model 5221-3
mfg 61024

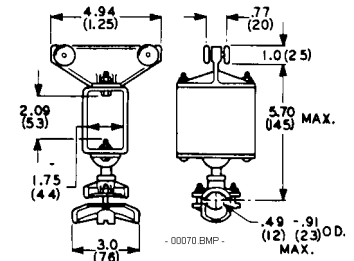

Model 5231-1
mfg 61023

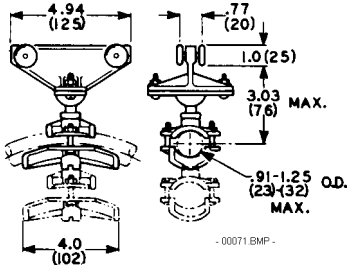

Model 5231-2
mfg 61019

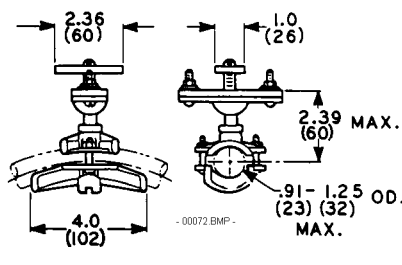

Model 5231-3
mfg 61025

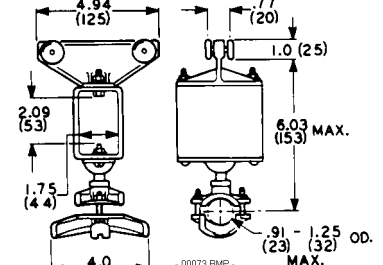

Extra saddles
Model 5122, mfg 58993
for round cable or hose 0.49"-0.91" OD

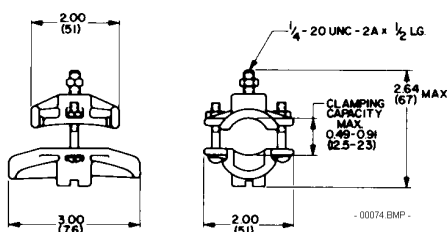

Extra saddles
Model 5132, mfg 58994
for round cable or hose 0.91"-1.25" OD

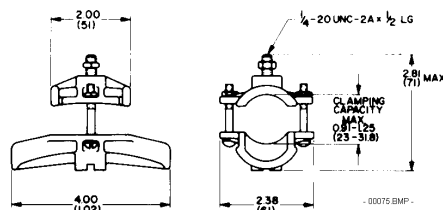

Track
Model 5200-6(6'), mfg 58802
Model 5200-12(12'), mfg 58800

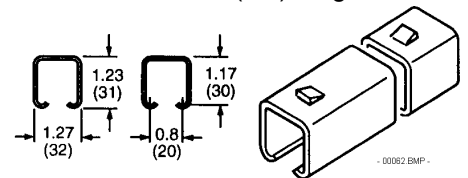

Hanger bracket
Model 5200-HB, mfg 58810

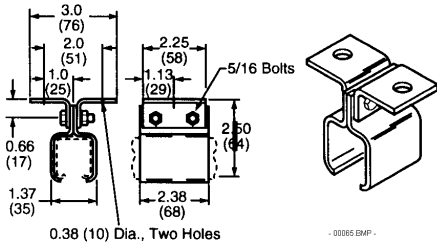

Joint bracket
Model 5200-JB, mfg 58828

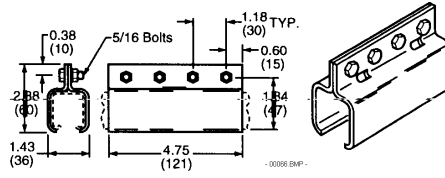

End cap
Model 5200-EC, mfg 58830

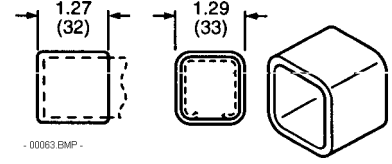

End stop
Model 5400-ES, mfg 59051

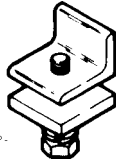
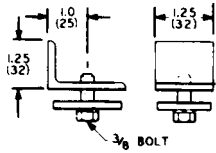

5400 Series Flat Cable Cars, End Clamps, & Lead Cars

Intermediate cars
Model 5410-1, mfg 59968

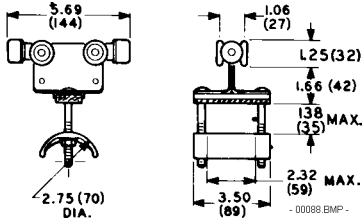

Model 5412-1, mfg 59969

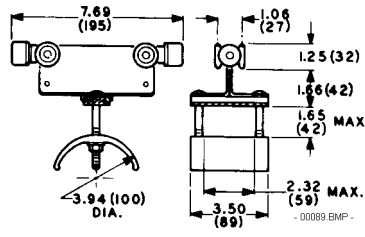

Model 5414-1, mfg 59970

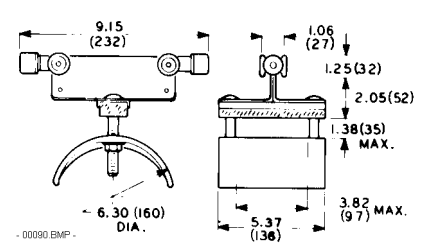

Aero-Motive Company

W A Woodhead Industries Inc. Subsidiary
5688 ML Avenue East
PO Box 2678
Kalamazoo, MI 49003-2678
(800)-999-8559
(800) 333-6119 FAX

Aero-Motive (UK) Limited

W A Woodhead Industries Inc. Subsidiary
9 Rassau Industrial Estate
EBBW Vale Gwent NP3 5SD
United Kingdom
(0495) 350436
(0495) 350877 FAX

Woodhead Asia PTE LTD

W A Woodhead Industries Inc. Subsidiary
8 Chia Ping Road #05-09/10
JTC Flatted Factory
Singapore 619973
(65) 261-6533
(65) 261-3588 FAX

Woodhead Canada LTD.

W A Woodhead Industries Inc. Subsidiary
1090 Brevik Place
Mississauga Ontario
L4W 3Y5 Canada
(905) 624-6518
(905) 624-9151 FAX