



Automotive NJM2904B/NJM2902B

High EMC Performance, Single Supply, Operational Amplifier

FEATURES

- NJM2904B ; AEC-Q100 grade 1 compliant
 - NJM2902B ; AEC-Q100 grade 1 in progress
 - Internal EMI filter
 - Operating voltage range +3V to +36V
 - Input offset voltage 0.5mV typ.
 - Consumption current NJM2904B: 0.7mA typ.
 - NJM2902B: 1.2mA typ.
 - Slew rate 0.4V/ μ s typ.
 - Unity-gain stability
 - Bipolar process
 - Package
- NJM2904BR-T1: MSOP8 (VSP8)
 NJM2902BVB4-T1: SSOP14-B4

GENERAL DESCRIPTION

The NJM2904B and NJM2902B are versatile operational amplifiers for automotive use.

The features took over from original NJM2904 and NJM2902 such as wide operating voltage range, common-mode input range to ground level or unity-gain stability, also improved EMC performance, ESD breakdown voltage and electric characteristics minimize the risks in parts replacement.

These basic products provide wide solutions for various automotive applications.



NJM2904BR-T1
MSOP8 (VSP8)
2.9 × 4.0 × 1.1 (mm)

NJM2902BVB4-T1
SSOP14-B4
5.0 × 6.4 × 1.45 (mm)

APPLICATIONS

- General use for automotive

Typical characteristics of EMC performance (Immunity)

The NJM2904B and NJM2902B achieved high immunity with IEC 62132-4 (DPI method) and ED-5008 benchmark with not only input terminals but also voltage supply terminals.

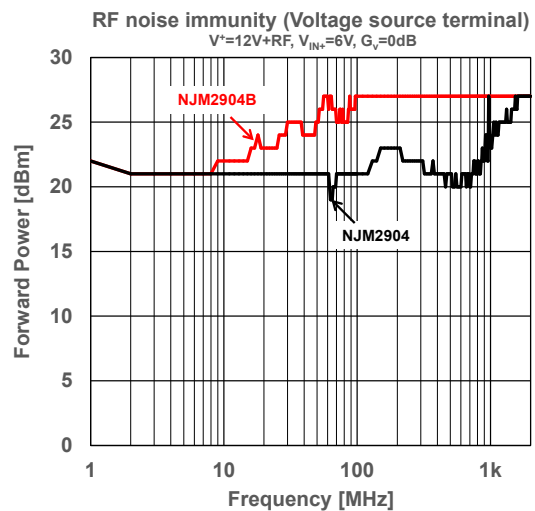
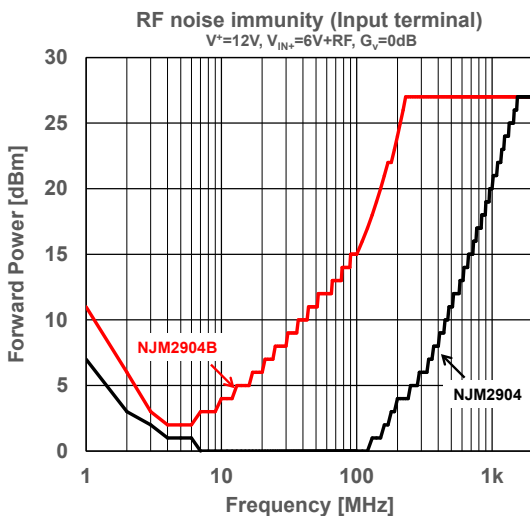

■ PRODUCT NAME INFORMATION

NJM290a B bbb - cc (ddd)

Description of configuration

Suffix	Parameter	Description
a	Channel	4: dual circuit 2: quad circuit
bbb	Package code	R; MSOP8(VSP8) VB4; SSOP14-B4 Indicates the package. Refer to the order information.
cc	Grade	T1; Automotive Indicates the quality grade.
ddd	Packing	TE1; Taping direction Refer to the packing specifications.

Grade

CC	Applications	Operating Temperature Range	Test Temperature
T1	Chassis, Body control and In-vehicle cockpit	-40°C to 125°C	-40, 25°C, 125°C

■ ORDER INFORMATION

PRODUCT NAME	PACKAGE	RoHS	HALOGEN-FREE	PLATING COMPOSITION	MARKING	WEIGHT (mg)	Quantity per Reel (pcs)
NJM2904BR-T1 (TE1)	MSOP8 (VSP8)	yes	yes	Sn-2Bi	2904BT1	21	2000
NJM2902BVB4-T1 (TE1)	SSOP14-B4	yes	yes	Sn-2Bi	02BT1	69	2000

■ PIN DESCRIPTIONS

PRODUCT	NJM2904BR-T1	NJM2902BVB4-T1
PACKAGE	MSOP8 (VSP8)	SSOP14-B4
Pin descriptions	<p>(Top View)</p>	<p>(Top View)</p>

NJM2904BR-T1 (Dual circuit)

PIN NO.	PIN NAME	DESCRIPTION
1	A OUTPUT	Channel A output
2	A -INPUT	Channel A negative input
3	A +INPUT	Channel A positive input
4	V ⁻	Negative supply
5	B +INPUT	Channel B positive input
6	B -INPUT	Channel B negative input
7	B OUTPUT	Channel B output
8	V ⁺	Positive supply

NJM2902BVB4-T1 (Quad circuit)

PIN NO.	PIN NAME	DESCRIPTION
1	A OUTPUT	Channel A output
2	A -INPUT	Channel A negative input
3	A +INPUT	Channel A positive input
4	V ⁺	Positive supply
5	B +INPUT	Channel B positive input
6	B -INPUT	Channel B negative input
7	B OUTPUT	Channel B output
8	C OUTPUT	Channel C output
9	C -INPUT	Channel C negative input
10	C +INPUT	Channel C positive input
11	V ⁻	Negative supply
12	D +INPUT	Channel D positive input
13	D -INPUT	Channel D negative input
14	D OUTPUT	Channel D output

■ Block Diagram (Single circuit)

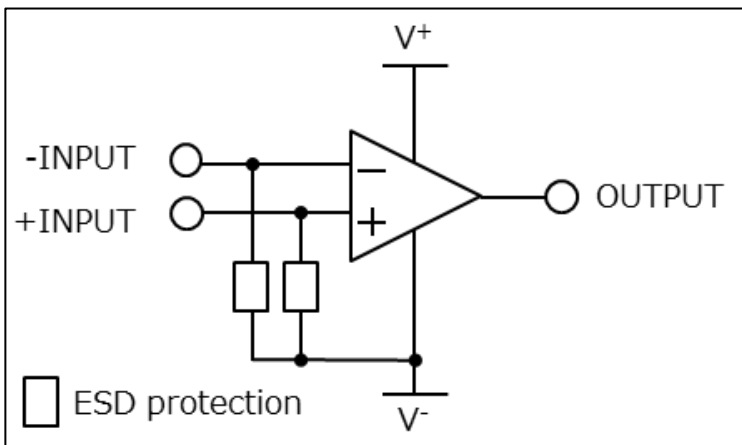

■ ABSOLUTE MAXIMUM RATINGS

Parameter	Symbol	Ratings	Unit
Supply Voltage	$V^+ - V^-$	36	V
Input Voltage ^{*1}	V_{IN}	$V^- -0.3$ to $V^+ +36$	V
Input Current ^{*1}	I_{IN}	-10	mA
Differential Input Voltage ^{*2}	V_{ID}	± 36	V
Applicable Voltage to Output terminals ^{*3}	V_O	$V^- -0.3$ to $V^+ +0.3$	V
Output Short-Circuit Duration ^{*4}		Continuous	
Package Dissipation ($T_a=25^\circ\text{C}$)	P_D	2-Layer / 4-Layer ^{*6}	
MSOP8 (VSP8)		570 / 770	mW
SSOP14-B4		890 / 1300	
Junction Temperature ^{*5}	T_j	150	$^\circ\text{C}$
Storage Temperature	T_{stg}	-50 to 150	$^\circ\text{C}$

^{*1} "Input Voltage" is independent of supply voltage. Normal operating range as operational amplifier is shown in "Common-Mode Input Voltage Range" of "ELECTRICAL CHARACTERISTICS".

Limit input current under 10mA by using limit resistor if input voltage is below $V^- -0.3\text{V}$.

Plus value of "Input Current" means sink direction, and minus value means source direction.

^{*2} "Differential Input Voltage" means potential difference between "+INPUT" and "-INPUT" terminals.

^{*3} Applicable voltage range to output pins from the outside without characteristic degradation or destruction.

^{*4} Short circuit from outputs to ground is allowed only when supply voltage is under 15V.

^{*5} Calculate the power consumption of the IC from the operating conditions, and calculate the junction temperature with the thermal resistance.

Please refer to "Thermal characteristics" for the thermal resistance under our measurement board conditions.

ABSOLUTE MAXIMUM RATINGS

Electronic and mechanical stress momentarily exceeded absolute maximum ratings may cause permanent damage and may degrade the lifetime and safety for both device and system using the device in the field. The functional operation at or over these absolute maximum ratings is not assured.

■ THERMAL CHARACTERISTICS

Parameter	Symbol	Measurement Result	Unit
Junction-to-Ambient Thermal Resistance	θ_{ja}	2-Layer / 4-Layer ^{*6}	
MSOP8 (VSP8)		220 / 163	$^\circ\text{C} / \text{W}$
SSOP14-B4		140 / 98	
Junction-to-Top Thermal Characterization Parameter	ψ_{jt}	2-Layer / 4-Layer ^{*6}	
MSOP8 (VSP8)		41 / 32	$^\circ\text{C} / \text{W}$
SSOP14-B4		15 / 14	

θ_{ja} : Junction-to-Ambient Thermal Resistance

ψ_{jt} : Junction-to-Top Thermal Characterization Parameter

^{*6} 2-Layer: Mounted on glass epoxy board (76.2 x 114.3 x 1.6mm, based on EIA/JEDEC standard, 2-layer FR-4)

4-Layer: Mounted on glass epoxy board (76.2 x 114.3 x 1.6mm, based on EIA/JEDEC standard, 4-layer FR-4, internal Cu area:74.2x74.2mm)

■ ELECTROSTATIC DISCHARGE RATINGS

Parameter	Conditions	Protection Voltage
HBM	C = 100 pF, R = 1.5 kΩ	±2000 V
CDM	Direct CDM	±1000 V

ELECTROSTATIC DISCHARGE RATINGS

The electrostatic discharge test is done based on JEITA ED-4701.
 In the HBM method, ESD is applied using the power supply pin and GND pin as reference pins.

■ RECOMMENDED OPERATING CONDITIONS

Parameter	Symbol	Ratings	Unit
Supply Voltage	V ⁺ - V ⁻	3 to 36	V
Operating Temperature	T _a	-40 to 125	°C

RECOMMENDED OPERATING CONDITIONS

All of electronic equipment should be designed that the mounted semiconductor devices operate within the recommended operating conditions. The semiconductor devices cannot operate normally over the recommended operating conditions, even if when they are used over such conditions by momentary electronic noise or surge. And the semiconductor devices may receive serious damage when they continue to operate over the recommended operating conditions.

■ ELECTRICAL CHARACTERISTICS

V⁺ = 5V, V⁻ = 0V, unless otherwise specified.

For parameter that do not describe the temperature condition, the MIN / MAX value under the condition of -40 °C ≤ T_a ≤ 125 °C is described.

NJM2904BR-T1 / NJM2902BVB4-T1

Parameter	Symbol	Test Conditions	Min	Typ	Max	Unit
Input Offset Voltage *1	V _{IO}	R _S = 50Ω, T _a = 25°C	-	0.5	2.5	mV
		R _S = 50Ω	-	-	3.0	
Input Offset Voltage Drift *1	ΔV _{IO} /ΔT	R _S = 50Ω	-	3	-	μV/°C
Input Offset Current *1	I _{IO}	T _a = 25°C	-	1	20	nA
			-	-	20	
Input Bias Current *1	I _B	T _a = 25°C	-	10	30	nA
			-	-	30	
Open-Loop Voltage Gain	A _V	R _L ≥ 2kΩ to V ⁺ / 2, T _a = 25°C	80	100	-	dB
		R _L ≥ 2kΩ to V ⁺ / 2	80	-	-	
		V ⁺ = 15V, R _L ≥ 2kΩ to V ⁺ / 2, T _a = 25°C	96	106	-	
		V ⁺ = 15V, R _L ≥ 2kΩ to V ⁺ / 2	90	-	-	
High-level Output Voltage	V _{OH}	R _L ≥ 2kΩ to 0V, T _a = 25°C	3.5	-	-	V
		R _L ≥ 2kΩ to 0V	3.2	-	-	
		V ⁺ = 30V, V ⁻ = 0V, R _L ≥ 10kΩ to 0V, T _a = 25°C	27.5	-	-	
		V ⁺ = 30V, V ⁻ = 0V, R _L ≥ 10kΩ to 0V	27.0	-	-	
Low-level Output Voltage	V _{OL}	R _L ≥ 2kΩ to 0V, T _a = 25°C	-	-	0.02	V
		R _L ≥ 2kΩ to 0V	-	-	0.02	
		V ⁺ = 30V, V ⁻ = 0V, R _L ≥ 10kΩ to 0V, T _a = 25°C	-	-	0.02	
		V ⁺ = 30V, V ⁻ = 0V, R _L ≥ 10kΩ to 0V	-	-	0.02	
Common-Mode Input Voltage Range	V _{ICM}	CMR ≥ 74dB, T _a = 25°C	0	-	V ⁺ -1.5	V
		CMR ≥ 66dB	0	-	V ⁺ -2.0	
Common-Mode Rejection Ratio	CMR	V _{ICM} = 0V to 3.5V, T _a = 25°C	74	90	-	dB
		V _{ICM} = 0V to 3.0V	66	-	-	
Supply Voltage Rejection Ratio	SVR	V ⁺ = 3.0V to 32V, T _a = 25°C	88	112	-	dB
		V ⁺ = 3.0V to 32V	76	-	-	
Output source current	I _{SOURCE}	V _{IN+} = 1V, V _{IN-} = 0V, T _a = 25°C	20	40	-	mA
		V _{IN+} = 1V, V _{IN-} = 0V	10	-	-	
Output sink current	I _{SINK}	V _{IN+} = 0V, V _{IN-} = 1V, T _a = 25°C	10	20	-	mA
		V _{IN+} = 0V, V _{IN-} = 1V	5	-	-	
Supply current (2 circuits)	I _{SUPPLY}	No signal, T _a = 25°C	-	0.7	1.2	mA
		No signal	-	-	1.2	
Supply current (4 circuits)	I _{SUPPLY}	No signal, T _a = 25°C	-	1.2	1.7	mA
		No signal	-	-	1.7	
Channel Separation	CS	f = 1kHz to 20kHz, as input value, T _a = 25°C	-	120	-	dB
Slew Rate	SR	V ⁺ / V ⁻ = ±15V, T _a = 25°C	-	0.4	-	V/μs
Gain Bandwidth Product	GBW	V ⁺ / V ⁻ = ±15V, T _a = 25°C	-	0.9	-	MHz
Total Harmonic Distortion + Noise	THD+N	f = 1kHz, Gain = 20dB, V _O = 2V _{PP} , R _L = 2kΩ to V ⁻ , C _L = 100pF, T _a = 25°C	-	0.02	-	%
Equivalent Input Noise Voltage	e _n	V ⁺ = 30V, f = 1kHz, R _S = 100Ω, T _a = 25°C	-	30	-	nV/√Hz

*1 Either plus or minus value is expressed in absolute value in electrical characteristics table.

■ TYPICAL APPLICATION NOTE

Improvement of Cross-over Distortion

Equivalent circuit at the output stage

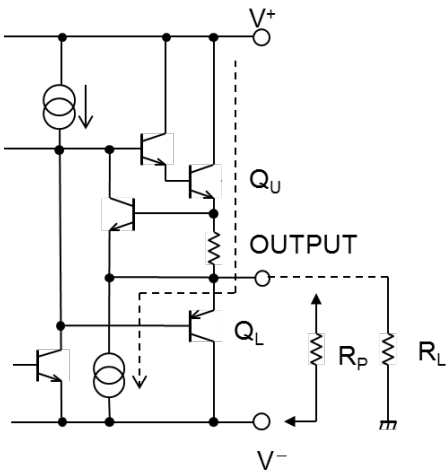

NJM2904B, in its static state (No in and output condition) when design, Q_U being biased by constant current (break down beam) yet, Q_L stays OFF.

While using with both power source mode, the cross-over distortion might occur instantly when Q_L ON.

There might be cases when application for amplifier of audio signals, not only distortion but also the apparent frequency bandwidth being narrowed remarkably.

It is adjustable especially when using both power source mode, constantly to use with higher current on Q_U than the load current (including feedback current), and then connect the pull-down resistor R_P at the part between output and V^- pins.

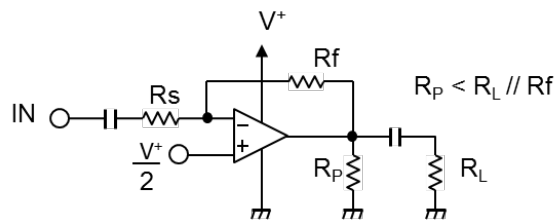
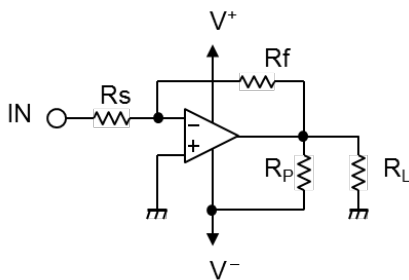

■ TYPICAL CHARACTERISTICS

Note: Following typical characteristics are reference, and not guaranteed.

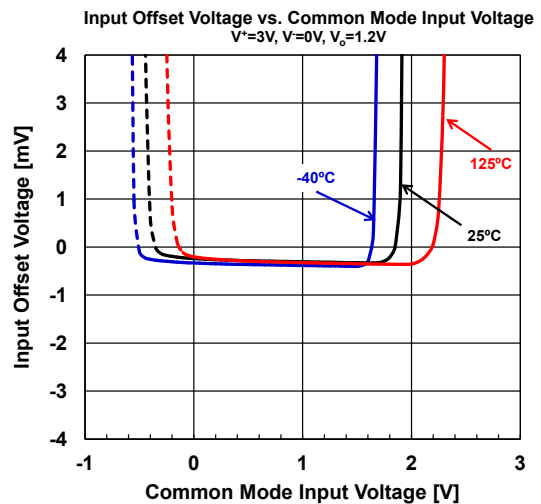
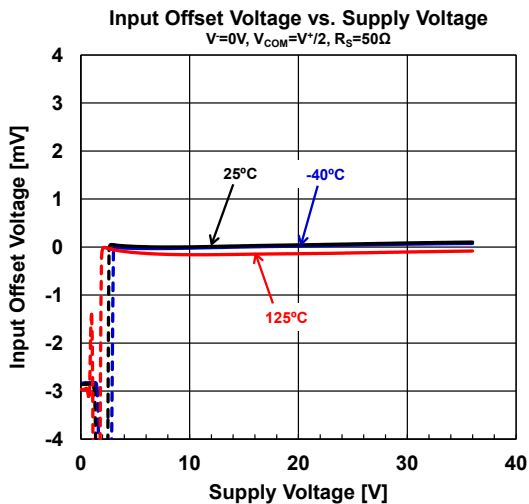
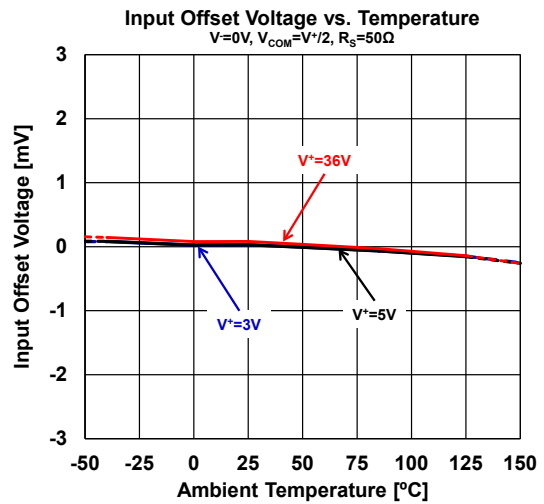
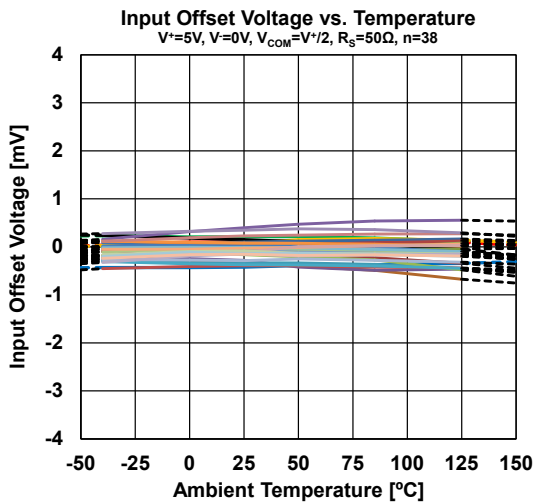
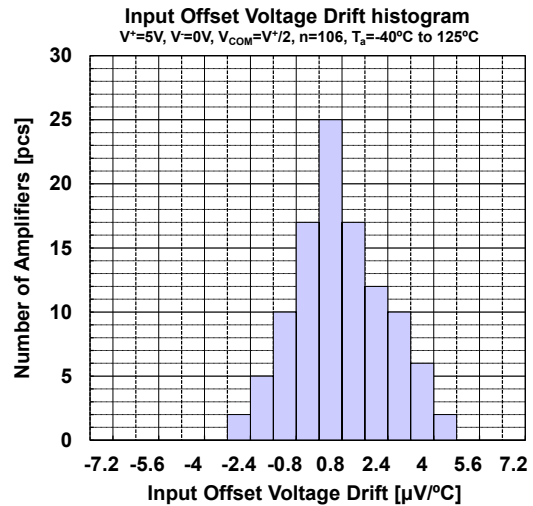
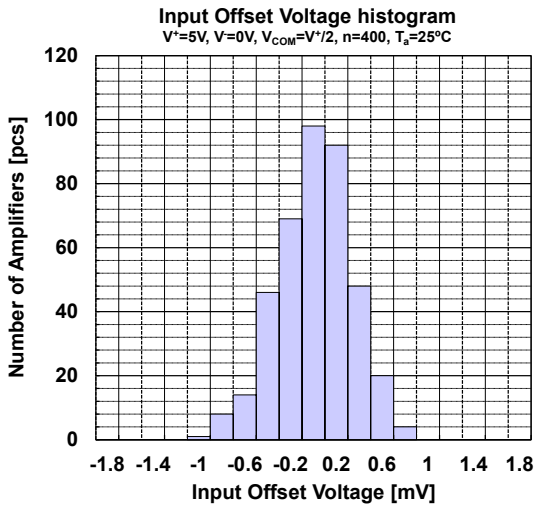

■ TYPICAL CHARACTERISTICS

Note: Following typical characteristics are reference, and not guaranteed.

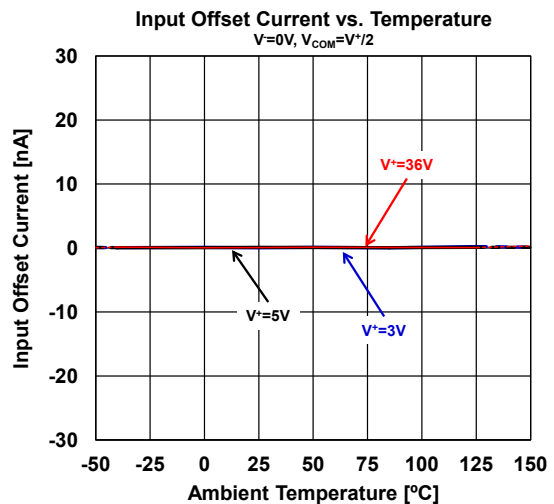
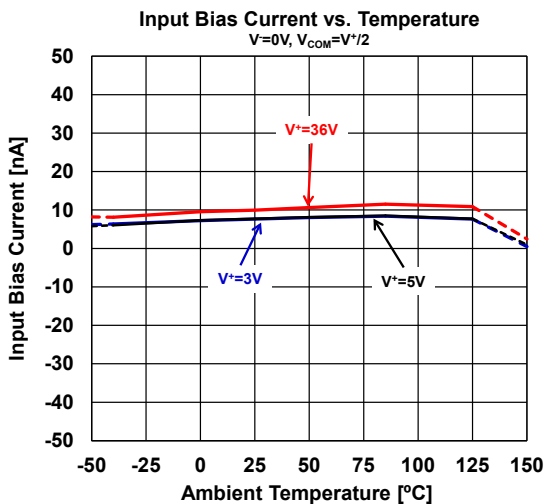
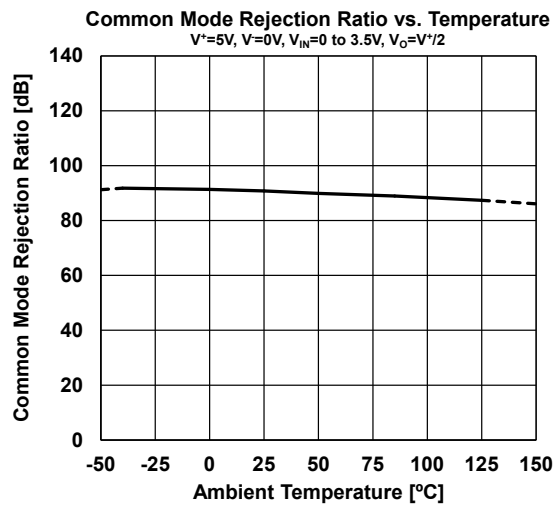
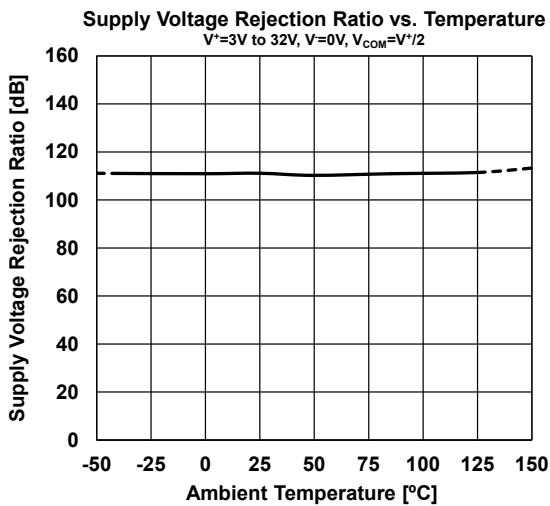
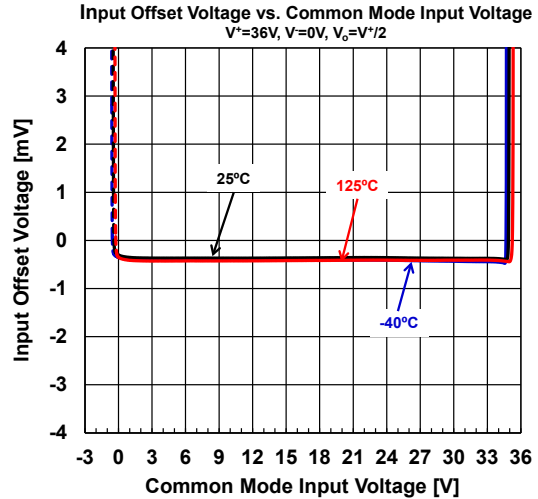
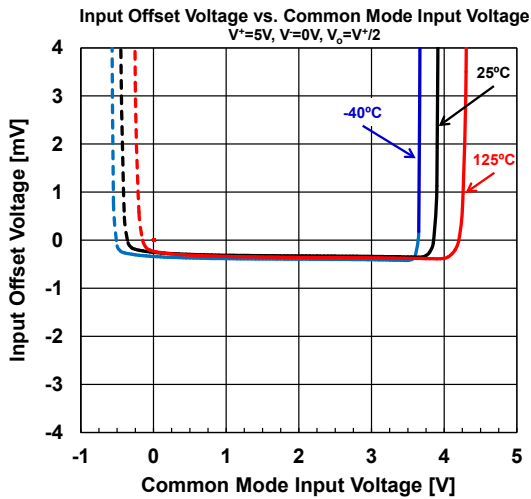

■ TYPICAL CHARACTERISTICS

Note: Following typical characteristics are reference, and not guaranteed.

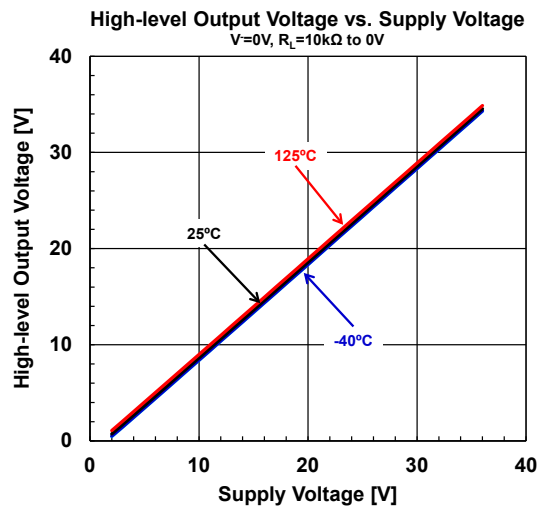
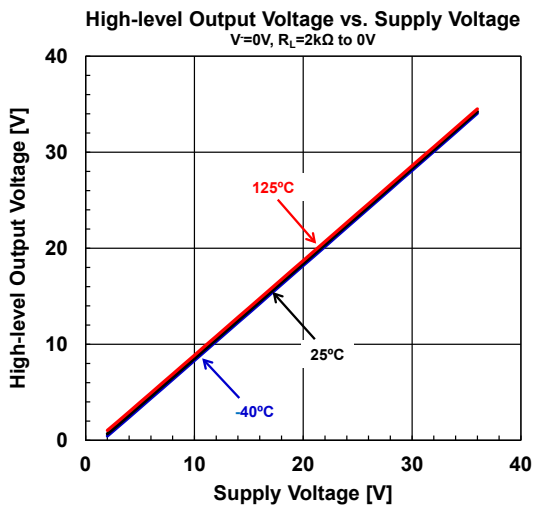
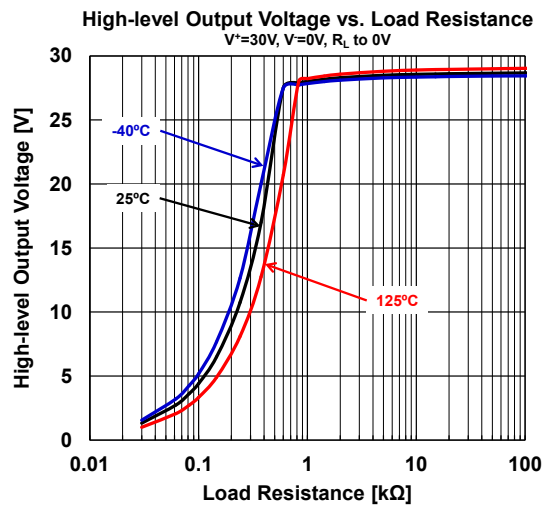
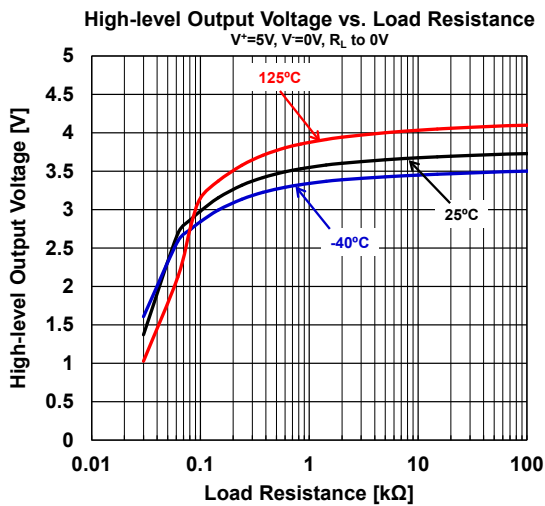
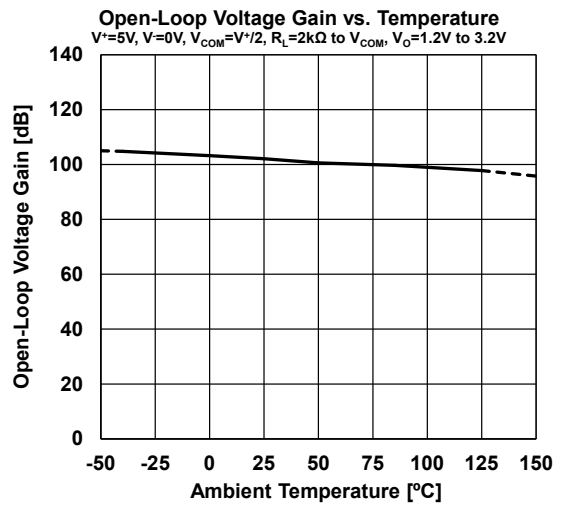
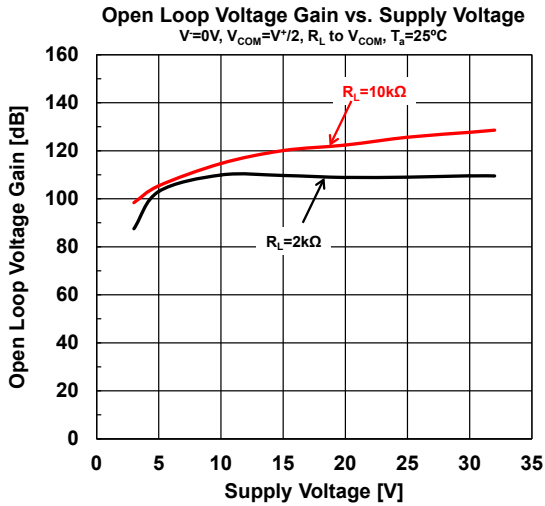

■ TYPICAL CHARACTERISTICS

Note: Following typical characteristics are reference, and not guaranteed.

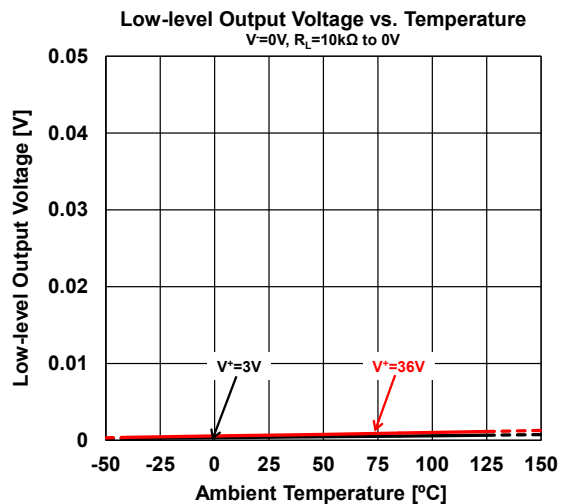
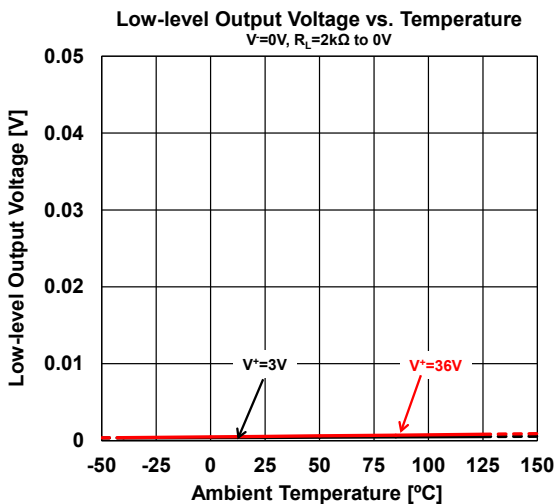
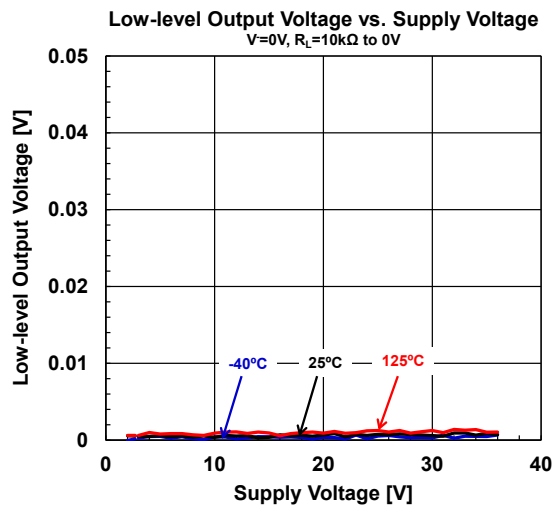
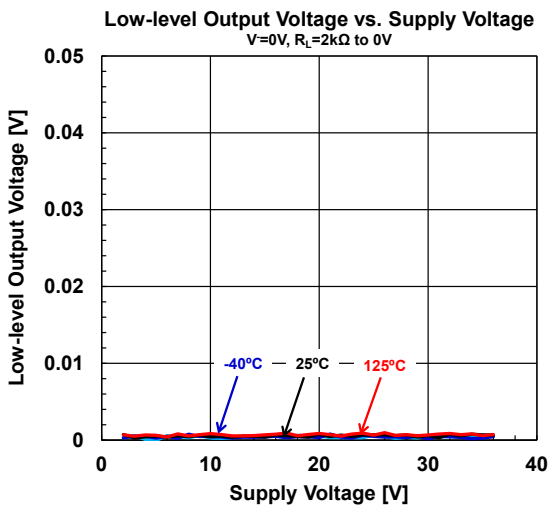
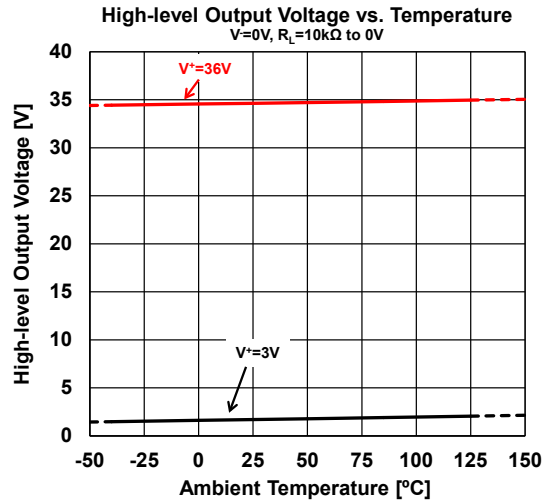
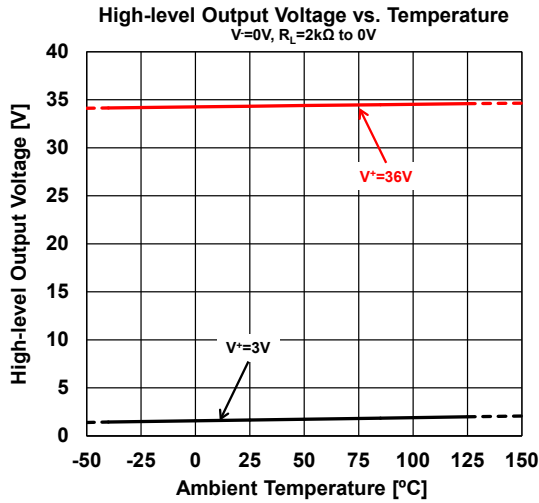

■ TYPICAL CHARACTERISTICS

Note: Following typical characteristics are reference, and not guaranteed.

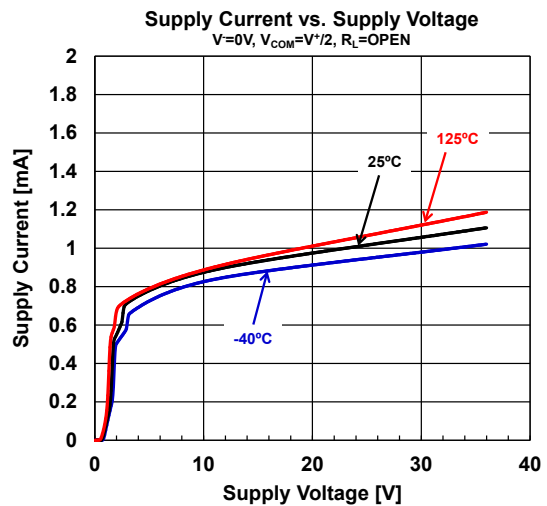
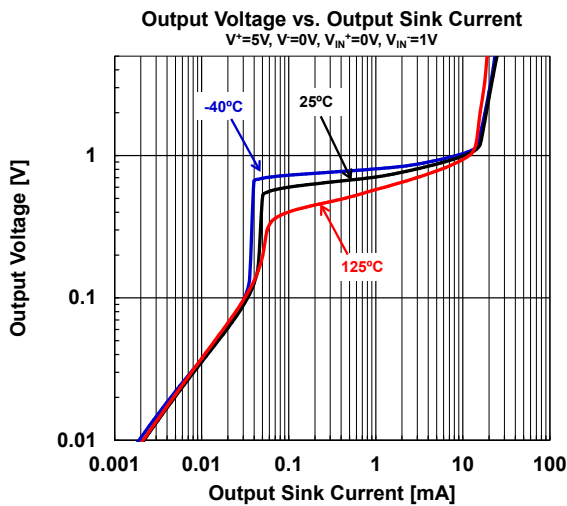
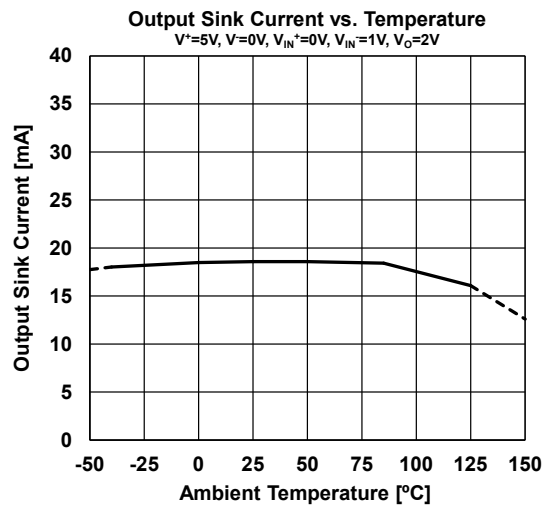
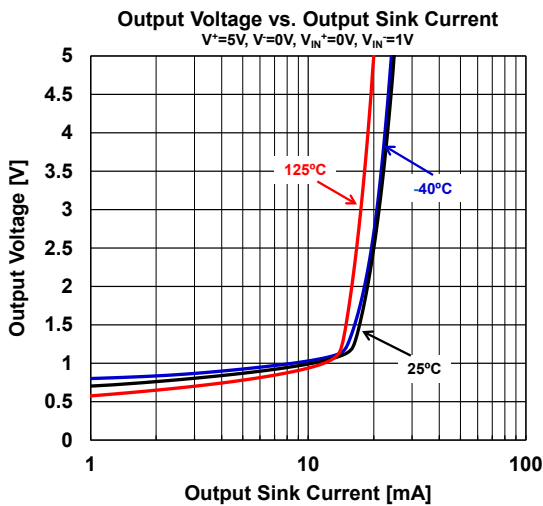
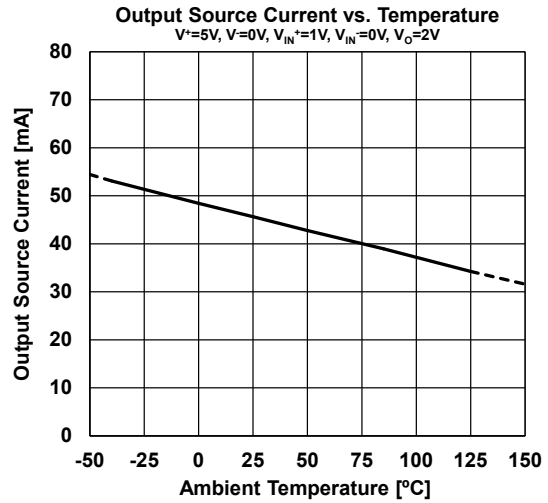
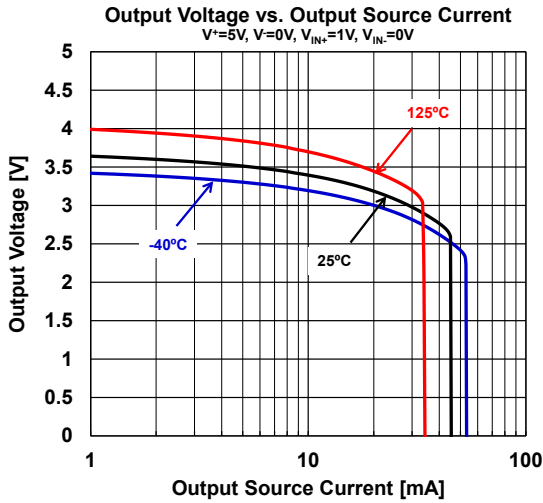

■ TYPICAL CHARACTERISTICS

Note: Following typical characteristics are reference, and not guaranteed.

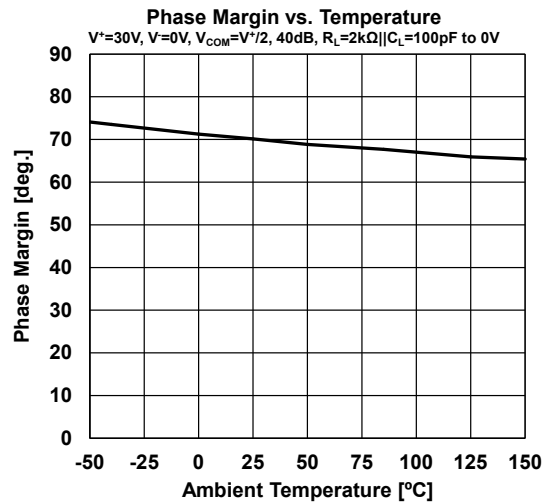
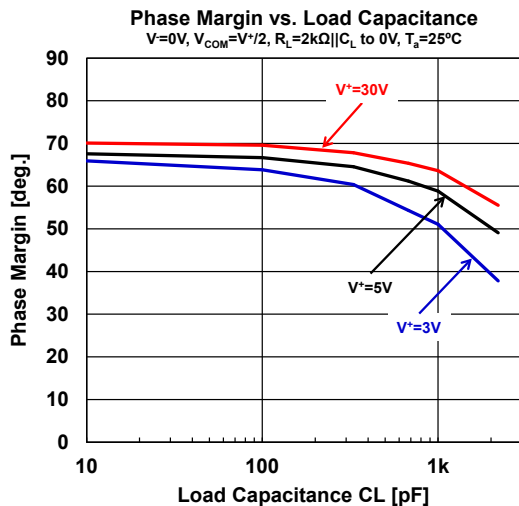
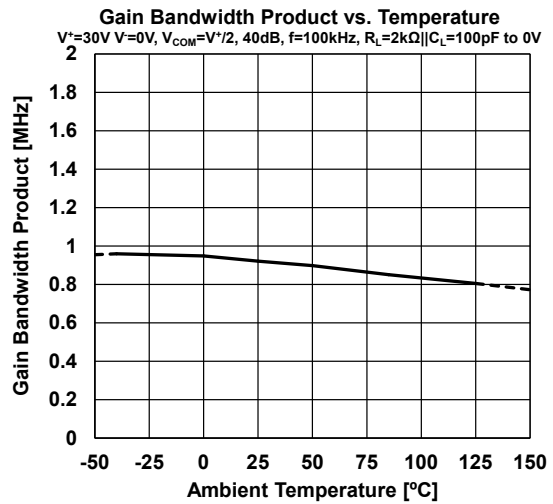
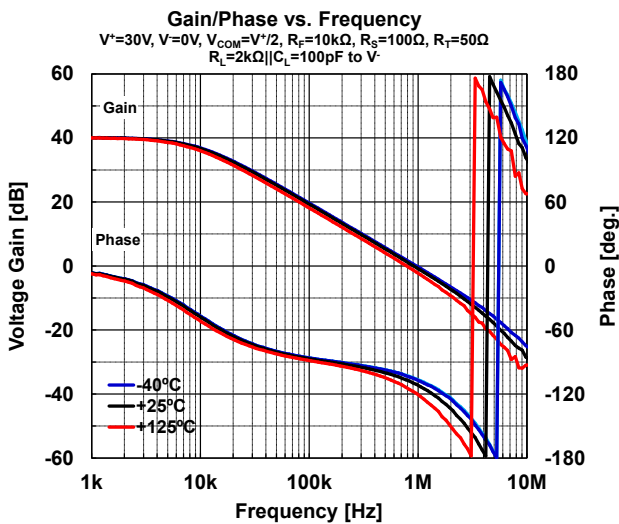
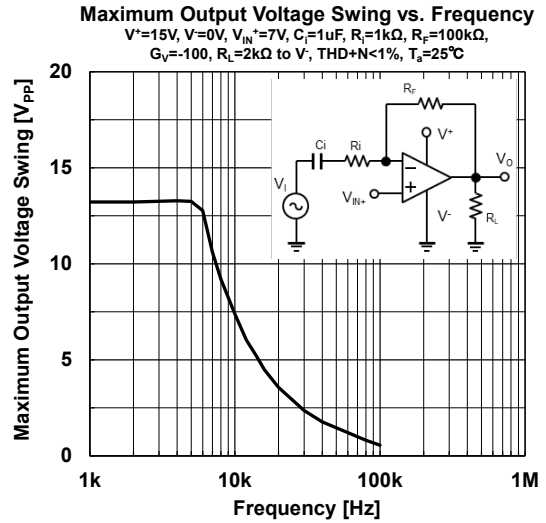
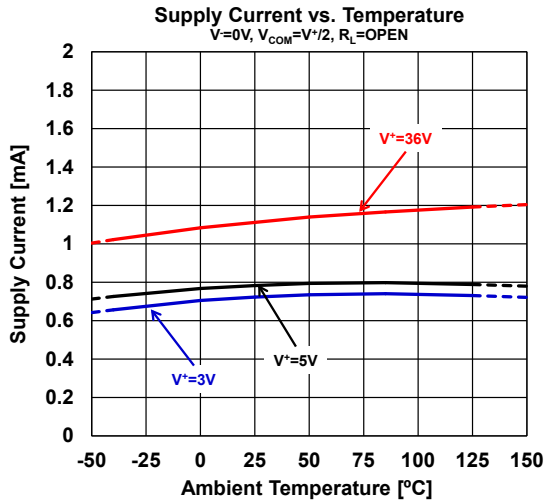

■ TYPICAL CHARACTERISTICS

Note: Following typical characteristics are reference, and not guaranteed.

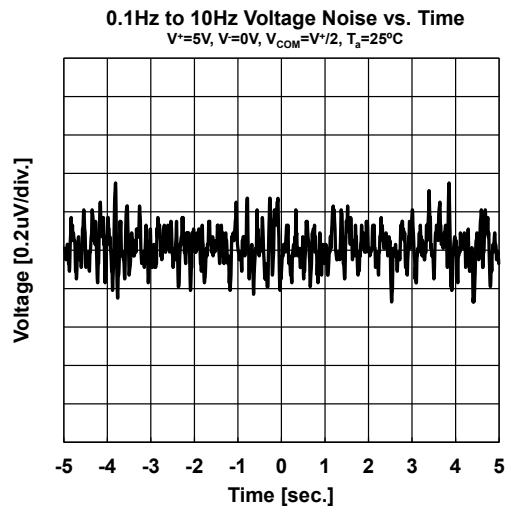
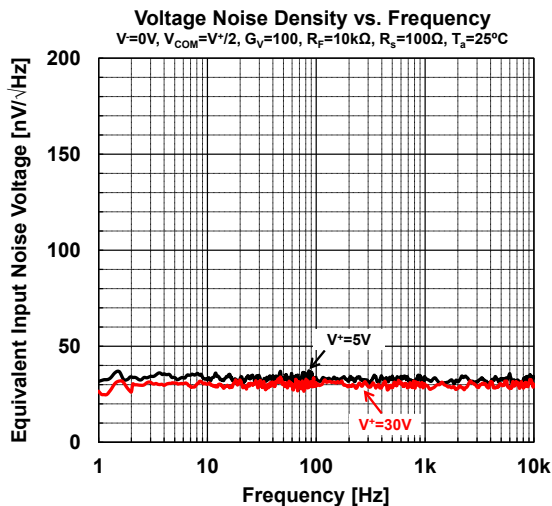
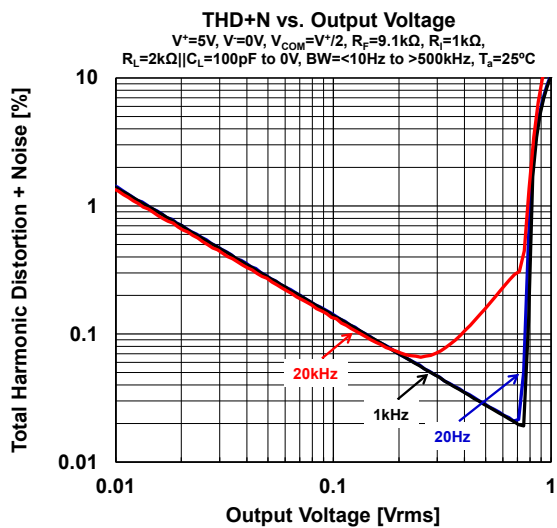
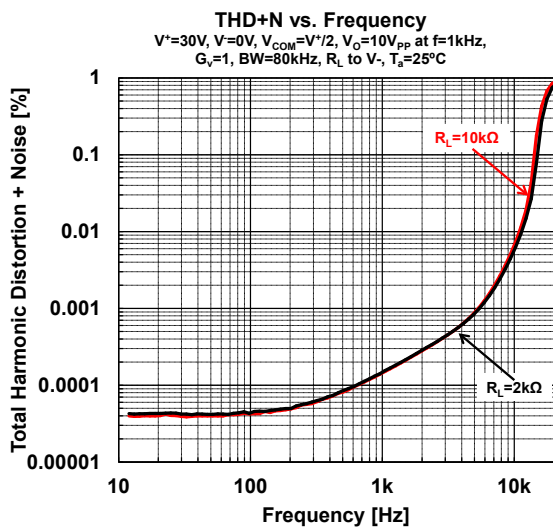
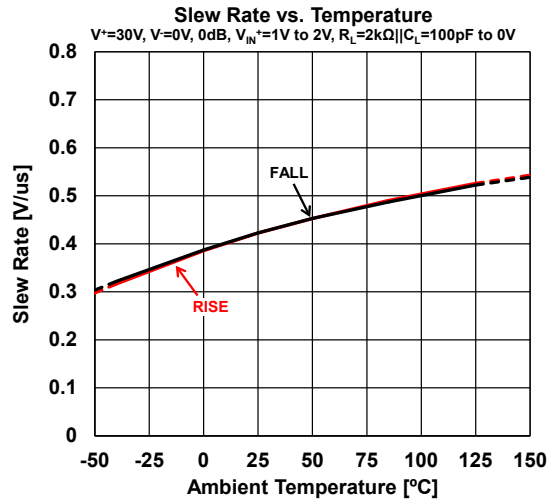
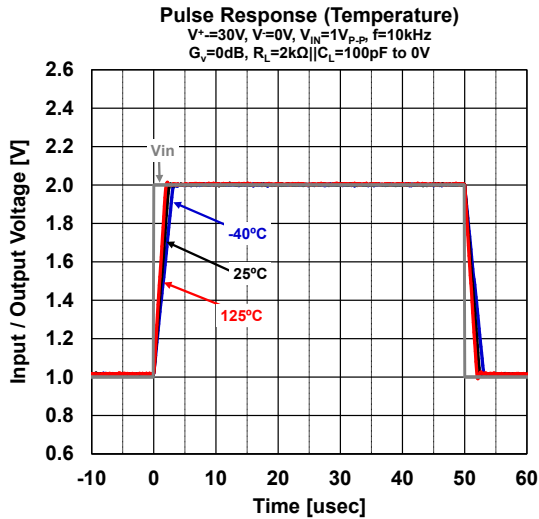

■ TYPICAL CHARACTERISTICS

Note: Following typical characteristics are reference, and not guaranteed.

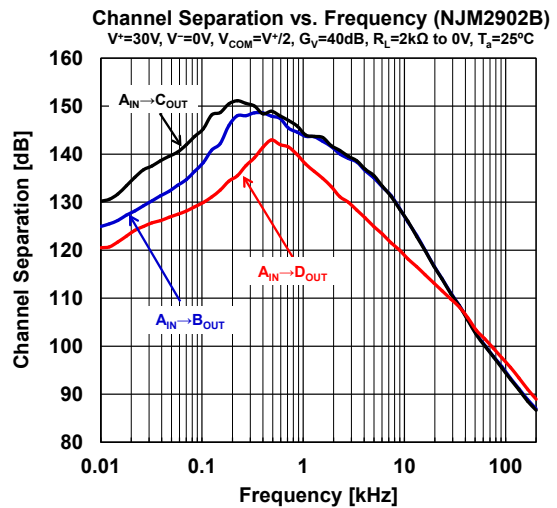
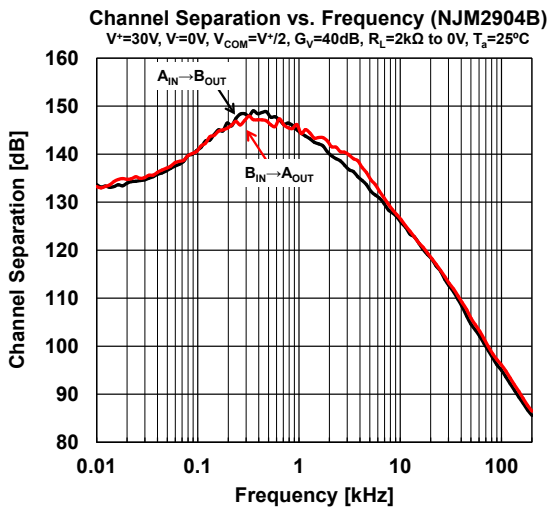
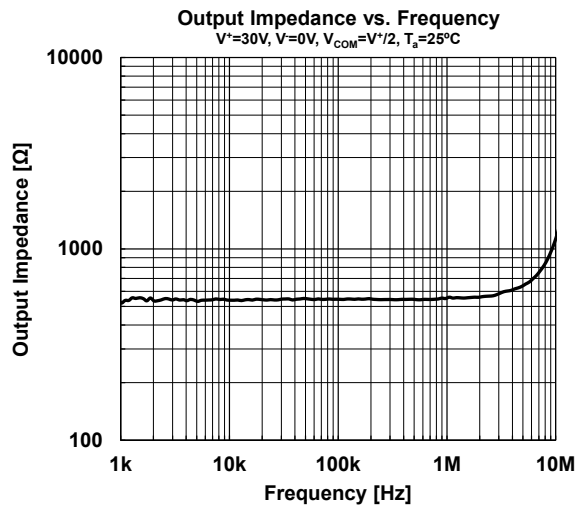
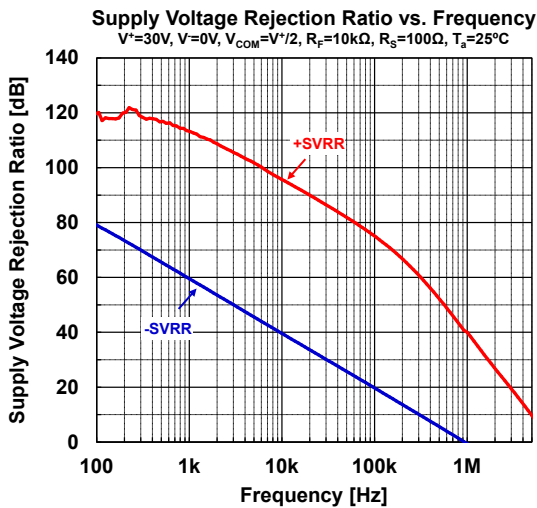
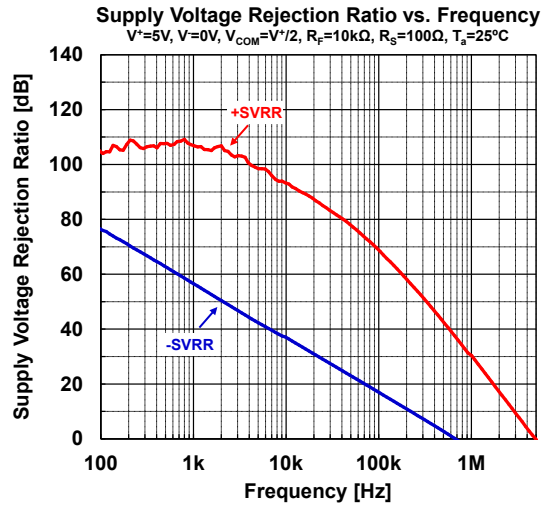
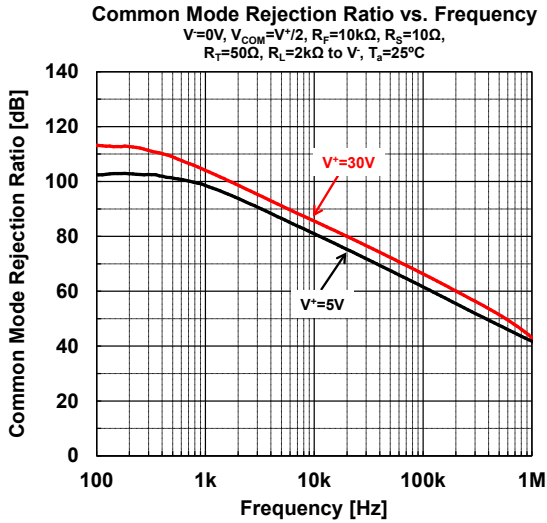

■ TEST CIRCUIT

• I_{SUPPLY}

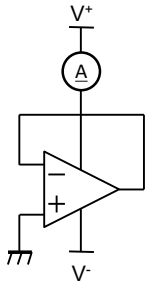

• V_{IO}, CMR, SVR

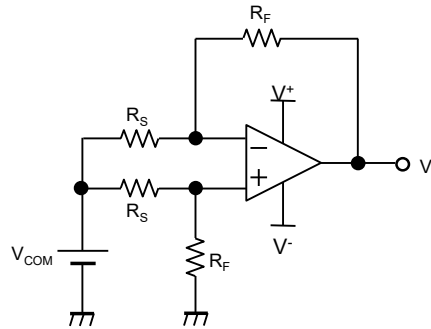

$$V_{IO} = \frac{R_S}{(R_S + R_F)} \times V_O$$

$$CMR = 20 \log \frac{\Delta V_{COM} \left(1 + \frac{R_F}{R_S}\right)}{\Delta V_O}$$

$$SVR = 20 \log \frac{\Delta V_S \left(1 + \frac{R_F}{R_S}\right)}{\Delta V_O}$$

$$V_S = V^+ - V^-$$

• V_{OH}, V_{OL}

V_{OH}; V_{IN+} = 1V, V_{IN-} = 0V
 V_{OL}; V_{IN+} = 0V, V_{IN-} = 1V

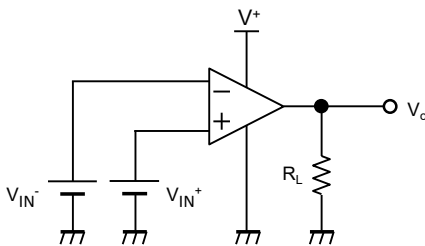

• GBW

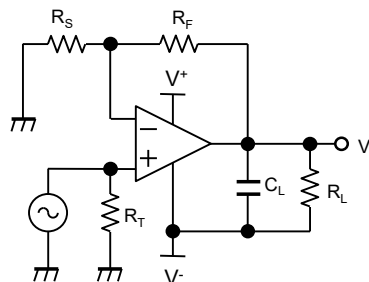

• SR

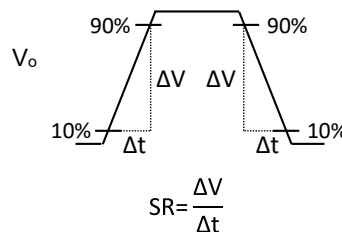
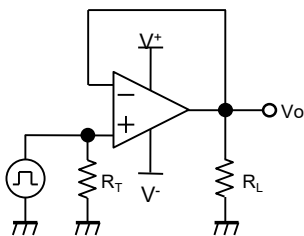

■ REVISION HISTORY

Date	Revision	Changes
September 15, 2022	Ver. 1.0	Initial release
May 31, 2023	Ver. 1.1	AEC-Q100 qualification JESD47 → JEITA ED-4701

Nisshinbo Micro Devices Inc.

MSOP8 (VSP8)

PI-VSP8-E-B

■ PACKAGE DIMENSIONS

UNIT: mm

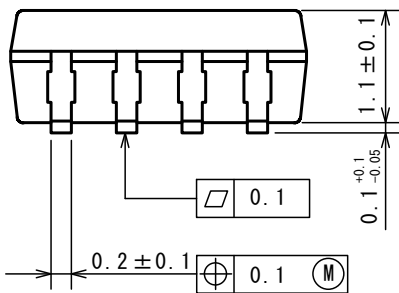
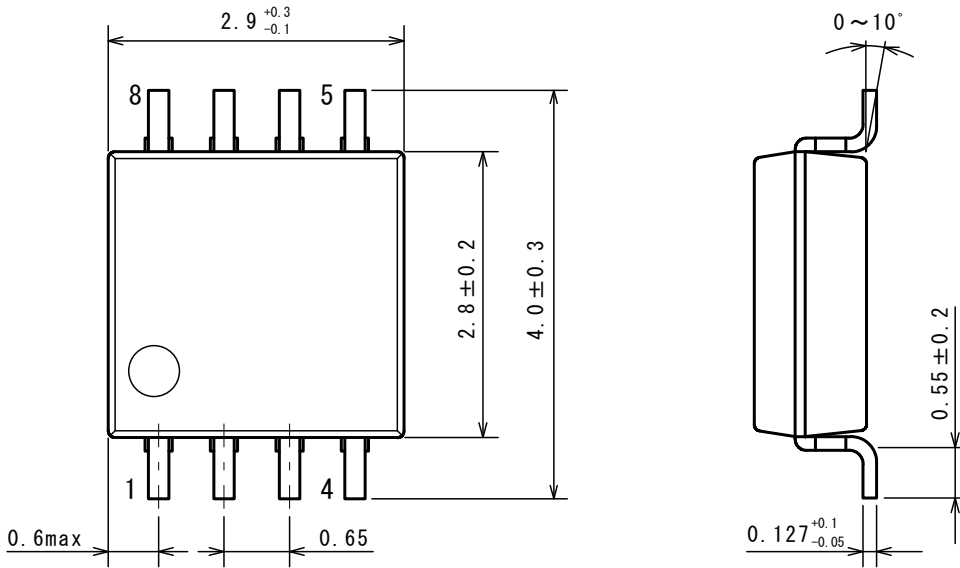

■ EXAMPLE OF SOLDER PADS DIMENSIONS

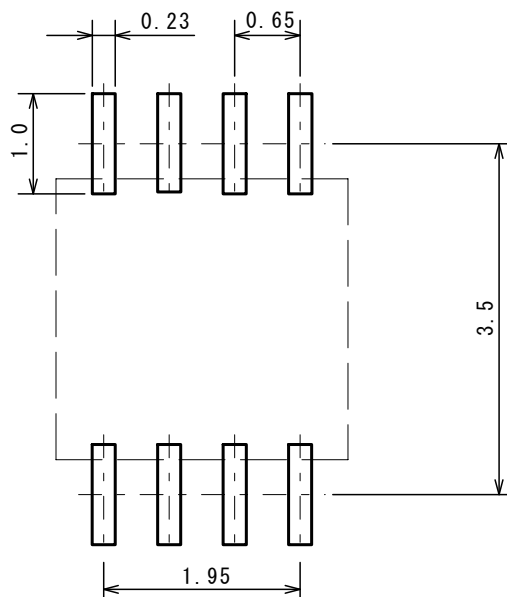

Nisshinbo Micro Devices Inc.

MSOP8 (VSP8)

PI-VSP8-E-B

PACKING SPEC

UNIT: mm

TAPING DIMENSIONS

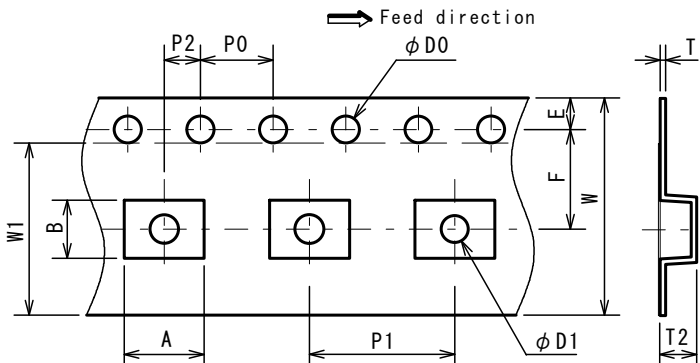

SYMBOL	DIMENSION	REMARKS
A	4.4	BOTTOM DIMENSION
B	3.2	BOTTOM DIMENSION
D0	1.5 ^{+0.1} ₀	
D1	1.5 ^{+0.1} ₀	
E	1.75±0.1	
F	5.5±0.05	
P0	4.0±0.1	
P1	8.0±0.1	
P2	2.0±0.05	
T	0.30±0.05	
T2	2.0 (MAX.)	
W	12.0±0.3	
W1	9.5	THICKNESS 0.1max

REEL DIMENSIONS

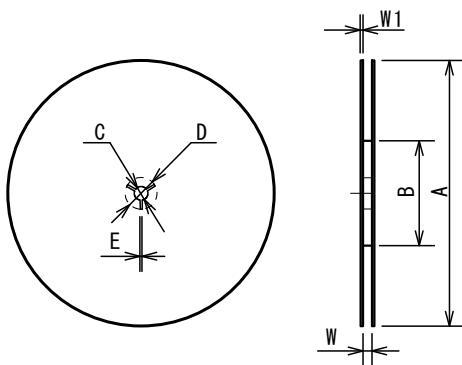

SYMBOL	DIMENSION
A	φ 254±2
B	φ 100±1
C	φ 13±0.2
D	φ 21±0.8
E	2±0.5
W	13.5±0.5
W1	2.0±0.2

TAPING STATE

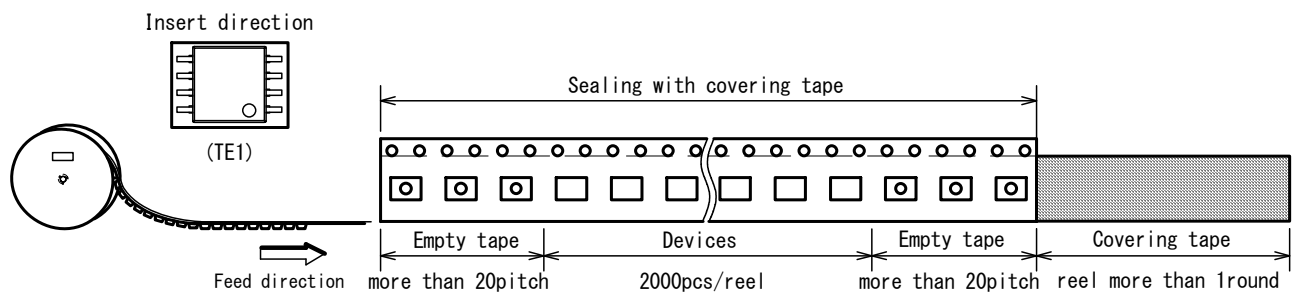

PACKING STATE

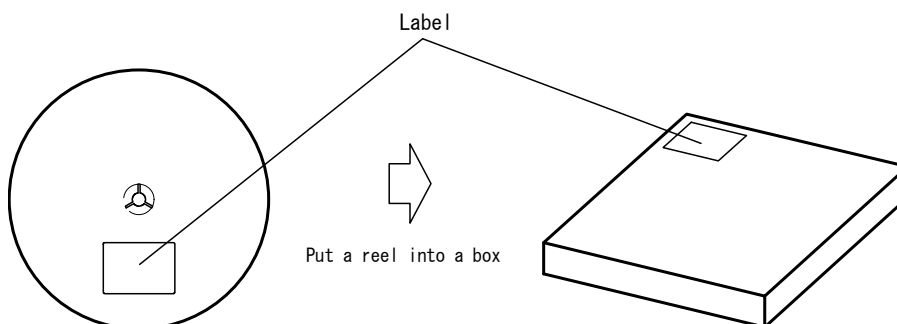

■ PACKAGE DIMENSIONS

UNIT: mm

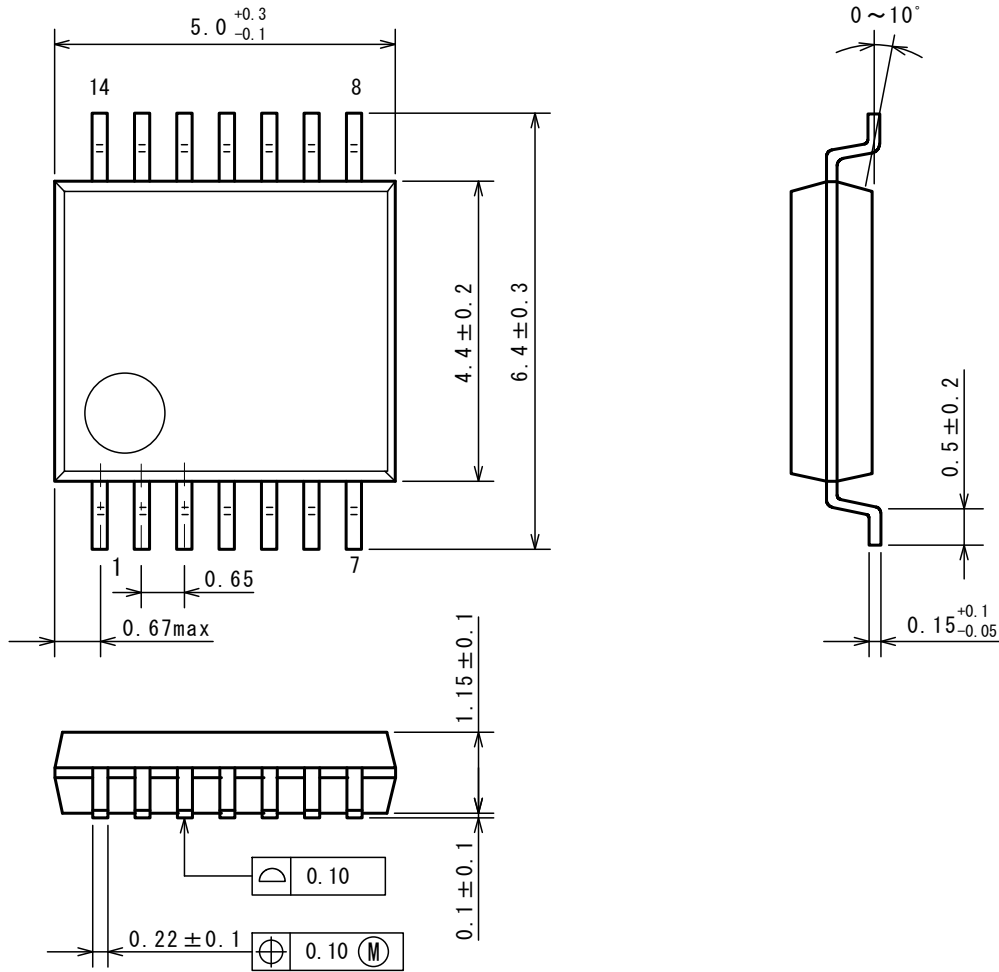

■ EXAMPLE OF SOLDER PADS DIMENSIONS

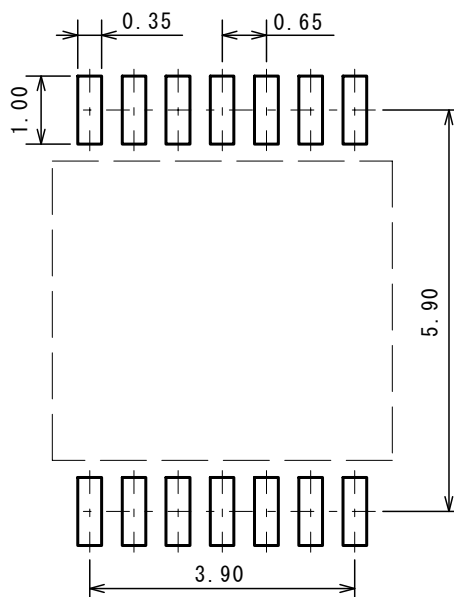

Nisshinbo Micro Devices Inc.

SSOP14-B4

PI-SSOP14-B4-E-A

■ PACKING SPEC

UNIT: mm

TAPING DIMENSIONS

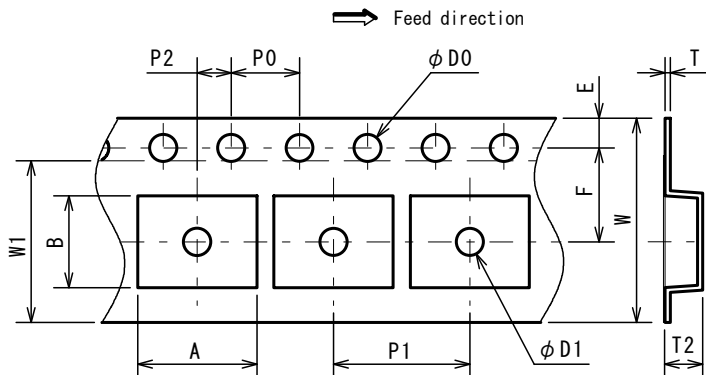

SYMBOL	DIMENSION	REMARKS
A	6.95	BOTTOM DIMENSION
B	5.4	BOTTOM DIMENSION
D0	1.55±0.05	
D1	1.55±0.1	
E	1.75±0.1	
F	5.5±0.05	
P0	4.0±0.1	
P1	8.0±0.1	
P2	2.0±0.05	
T	0.3±0.05	
T2	2.2	
W	12.0±0.3	
W1	9.5	THICKNESS 0.1max

REEL DIMENSIONS

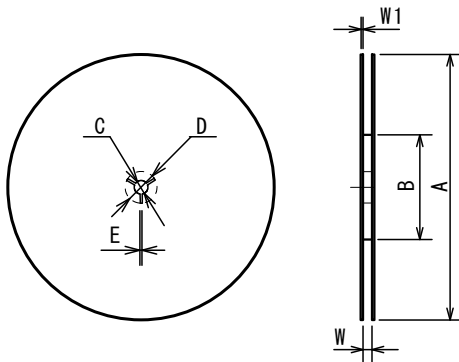

SYMBOL	DIMENSION
A	φ 254±2
B	φ 100±1
C	φ 13±0.2
D	φ 21±0.8
E	2±0.5
W	13.5±0.5
W1	2±0.2

TAPING STATE

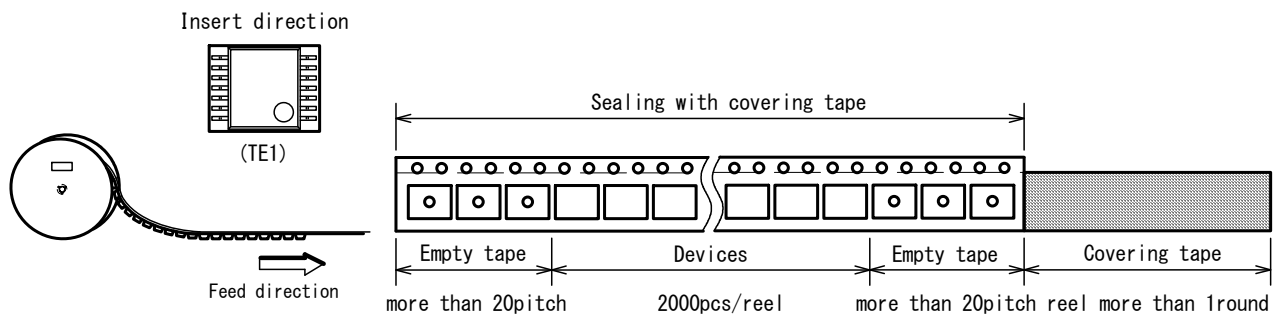

PACKING STATE

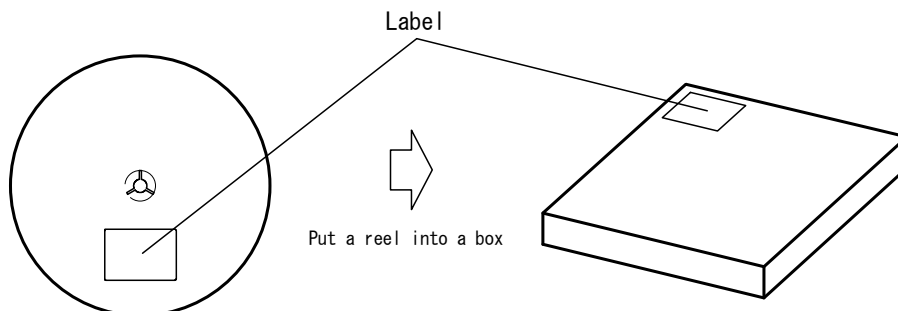

1. The products and the product specifications described in this document are subject to change or discontinuation of production without notice for reasons such as improvement. Therefore, before deciding to use the products, please refer to our sales representatives for the latest information thereon.
2. The materials in this document may not be copied or otherwise reproduced in whole or in part without the prior written consent of us.
3. This product and any technical information relating thereto are subject to complementary export controls (so-called KNOW controls) under the Foreign Exchange and Foreign Trade Law, and related politics ministerial ordinance of the law. (Note that the complementary export controls are inapplicable to any application-specific products, except rockets and pilotless aircraft, that are insusceptible to design or program changes.) Accordingly, when exporting or carrying abroad this product, follow the Foreign Exchange and Foreign Trade Control Law and its related regulations with respect to the complementary export controls.
4. The technical information described in this document shows typical characteristics and example application circuits for the products. The release of such information is not to be construed as a warranty of or a grant of license under our or any third party's intellectual property rights or any other rights.
5. The products listed in this document are intended and designed for automotive applications. Those customers intending to use a product in an application requiring extreme quality and reliability, for example, in a highly specific application where the failure or misoperation of the product could result in human injury or death should first contact us.
 - Aerospace Equipment
 - Equipment Used in the Deep Sea
 - Power Generator Control Equipment (nuclear, steam, hydraulic, etc.)
 - Life Maintenance Medical Equipment
 - Fire Alarms / Intruder Detectors
 - Vehicle Control Equipment (airplane, railroad, ship, etc.)
 - Various Safety Devices
 - Traffic control system
 - Combustion equipment

In case your company desires to use this product for any applications other than general electronic equipment mentioned above, make sure to contact our company in advance. Note that the important requirements mentioned in this section are not applicable to cases where operation requirements such as application conditions are confirmed by our company in writing after consultation with your company.

6. We are making our continuous effort to improve the quality and reliability of our products, but semiconductor products are likely to fail with certain probability. In order to prevent any injury to persons or damages to property resulting from such failure, customers should be careful enough to incorporate safety measures in their design, such as redundancy feature, fire containment feature and fail-safe feature. We do not assume any liability or responsibility for any loss or damage arising from misuse or inappropriate use of the products.
7. The products have been designed and tested to function within controlled environmental conditions. Do not use products under conditions that deviate from methods or applications specified in this datasheet. Failure to employ the products in the proper applications can lead to deterioration, destruction or failure of the products. We shall not be responsible for any bodily injury, fires or accident, property damage or any consequential damages resulting from misuse or misapplication of the products.
8. **Quality Warranty**
 - 8-1. **Quality Warranty Period**
In the case of a product purchased through an authorized distributor or directly from us, the warranty period for this product shall be one (1) year after delivery to your company. For defective products that occurred during this period, we will take the quality warranty measures described in section 8-2. However, if there is an agreement on the warranty period in the basic transaction agreement, quality assurance agreement, delivery specifications, etc., it shall be followed.
 - 8-2. **Quality Warranty Remedies**
When it has been proved defective due to manufacturing factors as a result of defect analysis by us, we will either deliver a substitute for the defective product or refund the purchase price of the defective product.
Note that such delivery or refund is sole and exclusive remedies to your company for the defective product.
 - 8-3. **Remedies after Quality Warranty Period**
With respect to any defect of this product found after the quality warranty period, the defect will be analyzed by us. On the basis of the defect analysis results, the scope and amounts of damage shall be determined by mutual agreement of both parties. Then we will deal with upper limit in Section 8-2. This provision is not intended to limit any legal rights of your company.
9. Anti-radiation design is not implemented in the products described in this document.
10. The X-ray exposure can influence functions and characteristics of the products. Confirm the product functions and characteristics in the evaluation stage.
11. WLCSP products should be used in light shielded environments. The light exposure can influence functions and characteristics of the products under operation or storage.
12. Warning for handling Gallium and Arsenic (GaAs) products (Applying to GaAs MMIC, Photo Reflector). These products use Gallium (Ga) and Arsenic (As) which are specified as poisonous chemicals by law. For the prevention of a hazard, do not burn, destroy, or process chemically to make them as gas or power. When the product is disposed of, please follow the related regulation and do not mix this with general industrial waste or household waste.
13. Please contact our sales representatives should you have any questions or comments concerning the products or the technical information.



Nisshinbo Micro Devices Inc.

Official website

<https://www.nisshinbo-microdevices.co.jp/en/>

Purchase information

<https://www.nisshinbo-microdevices.co.jp/en/buy/>