

E-BOX

The Housing for RAFIX 22 FS Control Components



E-BOX

Housing for RAFIX 22 FS Control Components



The RAFIX 22 FS E-Box is an elegant, extremely well-designed housing for control components. It can be used wherever individual control component units are required in remote places. Very typical, for example, for Emergency-Stop applications along a production line or on the safety fence.

The dimensions of the RAFIX 22 FS E-BOX and also the assembly concept are based on the edge dimension of a 40 mm profile rail.

Simple assembly concept, based on 40 mm profile rails

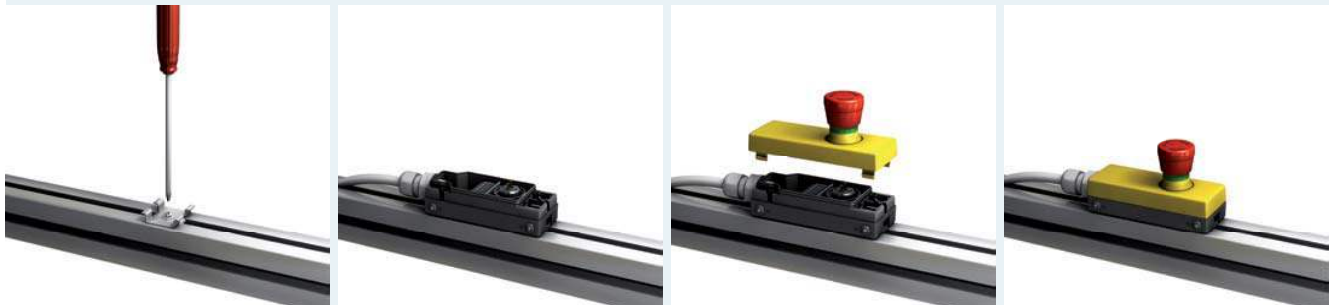

- Insert metal clip in profile rail slot (locating noses on the clip ensure precise adjustment, fix with only one screw)
- The metal clip can also be screwed onto other surfaces.
- Mount housing bottom part
- Attach contact module
- Insert the wires
- Connect the terminals
- Insert RAFIX 22 FS actuator (e.g. Emergency-Stop) into housing top part
- Fix actuator with a ring nut
- Snap housing top part onto bottom part. Done!

Drilling pattern for direct mounting with screws

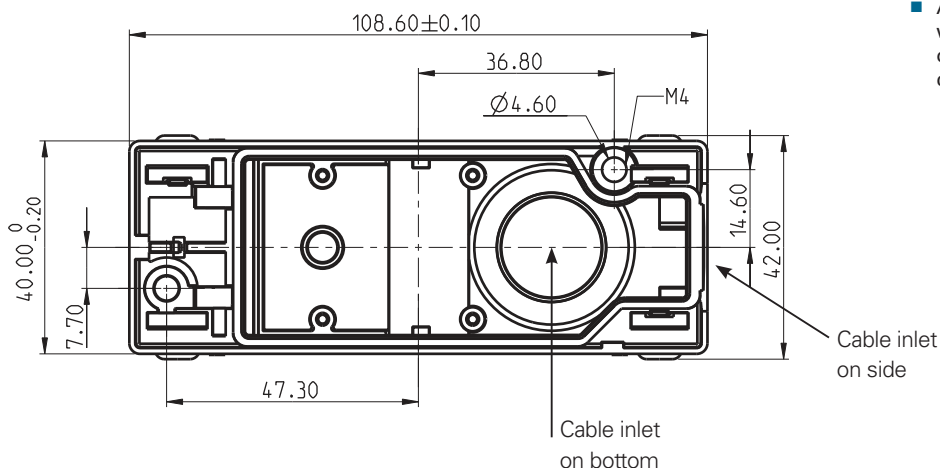

- As an alternative to mounting with the metal clip, the bottom of the housing can be attached directly with M4 screws.

Housing

- Extremely compact (dimensions 109 x 40 x 27 mm)
- Suitable for actuators from the RAFIX 22 FS control unit range (ø 22.3 mm)
- With yellow housing cap for Emergency-Stop actuator
- With grey housing cap for standard actuators (such as pushbuttons)
- Fixing
 - with the timesaving one-hole screw attachment method, particularly suitable for aluminium profile rails
 - or alternatively by direct attachment with M4 screws
- Includes cable lead-in for direct cabling
 - side: M16
 - bottom: M20

Technical data

- Protection as per EN 60529: IP 65
- Protection class II
- Temperature range as per IEC 60947-5-1¹

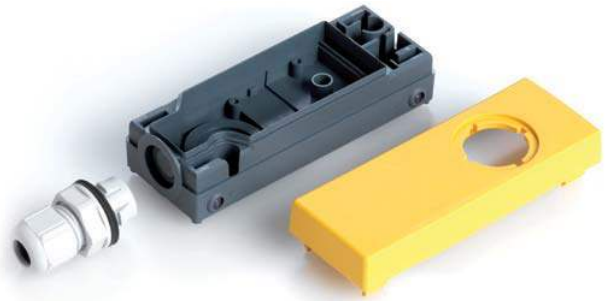

¹ Depending on actuators used

Contact module

- With RAFIX 22 FS contact block for
 - Emergency-Stop actuator or
 - Standard actuator
- Contact block with 2 contact cavities (for Emergency-Stop "PLUS1" with 3 contacts)
- Option with LED for illuminated actuator components
- Line connection (max. 1.5 mm²)
 - in bottom of housing
 - with spring clamp (rigid wire, wire with or without cable end sleeve)

General information: contact modules

- Working temperature: -40 °C - +85 °C
- Storage temperature: -40 °C - +85 °C
- Shock resistance as per EN 60068-2-27
- Vibration resistance as per EN 60068-2-6
- Resistance to environmental conditions as per EN 60068-2

Technical data

Contact module with gold contact blocks

- Electrical characteristics:
 - operating voltage AC/DC min. 5 V
 - operating voltage AC/DC max. 35 V
 - operating current AC/DC min. 1 mA
 - operating current AC/DC max. 100 mA
 - switching capacity max. 250 mW
- Life cycle at 10 mA / 24 V DC 1,000,000 (Emergency-Stop "PLUS1": 50,000)

Technical data

Contact module with silver contact blocks

- Electrical characteristics as per IEC 60947, AC-15, DC-13:
 - rated insulation voltage AC/DC min. 250 V
 - rated impulse voltage 2500 V
 - rated operating current
 - IE, AC15 B300 3 A / 120 V; 1.5 A / 240 V
 - I_{the}: 5 A
 - rated operating current
 - IE, DC13 Q300 550 mA / 120 V; 270 mA / 240 V
 - I_{the}: 2.5 A
- Life cycle (min.)
 - 1,000,000 at 250 V / 1 A
 - 100,000 at 250 V / 2 A
 - 30,000 at 250 V / 4 A



E-BOX Housing

for Emergency-Stop/Emergency-Off Applications

E-BOX, yellow housing

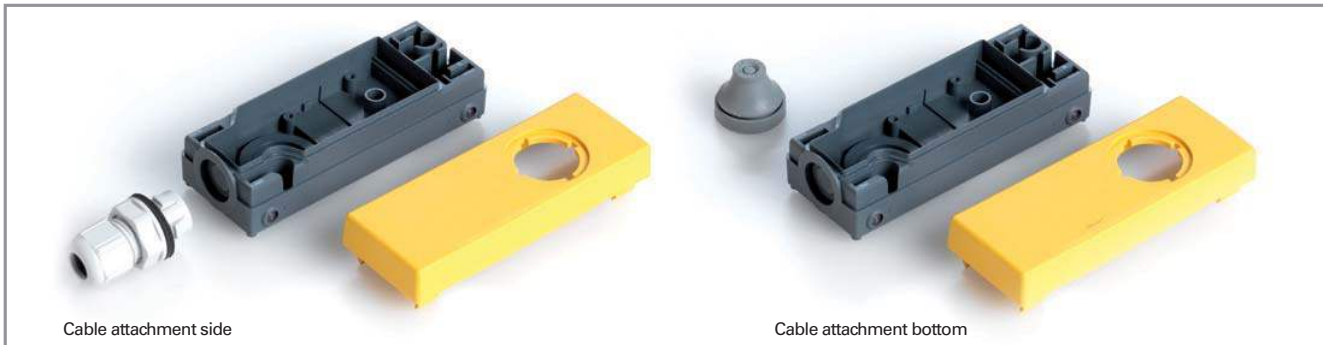

E-BOX housing	Cable attachment	Colour of top	Order no.
housing	side M16	yellow	1.20.810.302/0000
housing	bottom M20	yellow	1.20.810.304/0000

RAFIX 22 FS, E-Stop pushbutton

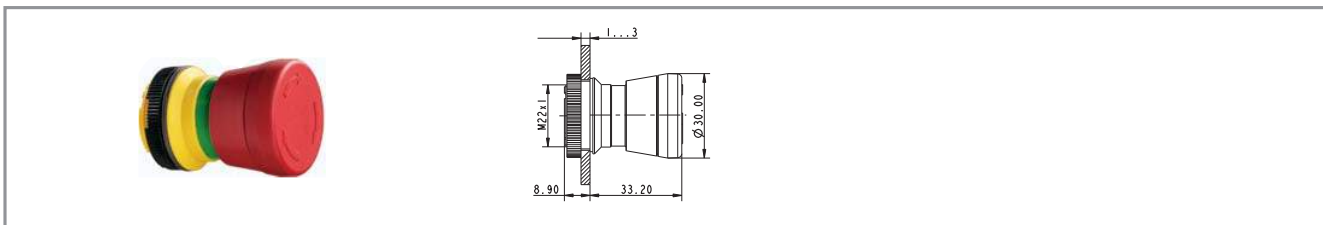

Reset	Illuminated	IP protection on front side	Order no.
by turning clockwise	no	IP 65	1.30.253.501/0300
by turning clockwise	yes, window transparent uncoloured	IP 65	1.30.253.001/1000
by turning clockwise	yes, window transparent red	IP 65	1.30.253.001/0300
by pulling	no	IP 69 K	1.30.253.601/0300
by pulling	yes, window transparent uncoloured	IP 69 K	1.30.253.101/0300
by pulling	yes, window transparent red	IP 69 K	1.30.253.101/1300
by turning clockwise	no	IP 65	1.30.253.502/0300 „PLUS 1“
by pulling	no	IP 69 K	1.30.253.602/0300 „PLUS 1“

For details see RAFI catalogue „Electromechanical Components“, chapter RAFIX 22 FS.

E-Box contact modules for Emergency-Stop/Emergency-Off applications



E-Box contact module	RAFIX 22 FS	Contact material	Contacts	LED / colour	Order no.
E-Stop/E-Off	E-Stop	gold	2 NC	none	5.00 100.221/0000
E-Stop/E-Off	E-Stop	gold	2 NC	LED red	5.00 100.222/0000
E-Stop/E-Off	E-Stop	gold	2 NC	LED white	5.00 100.224/0000
E-Stop/E-Off	E-Stop	gold	2 NC	LED green	5.00 100.225/0000
E-Stop/E-Off	E-Stop "PLUS 1"	gold	2 NC + 1 NO	none	5.00 100.226/0000
E-Stop/E-Off	E-Stop	silver	2 NC	none	5.00 100.227/0000

For technical data see page 3.

Dimensional drawing

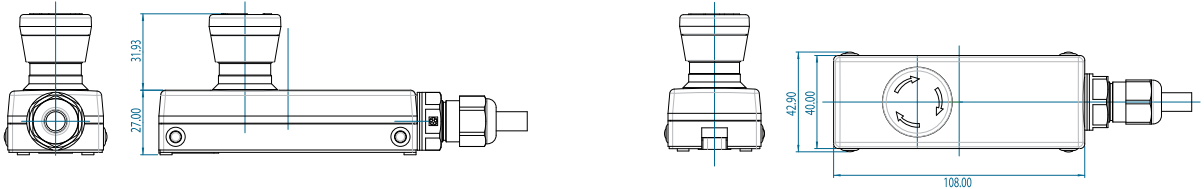

E-BOX Housing

for Standard Applications

E-BOX, grey housing

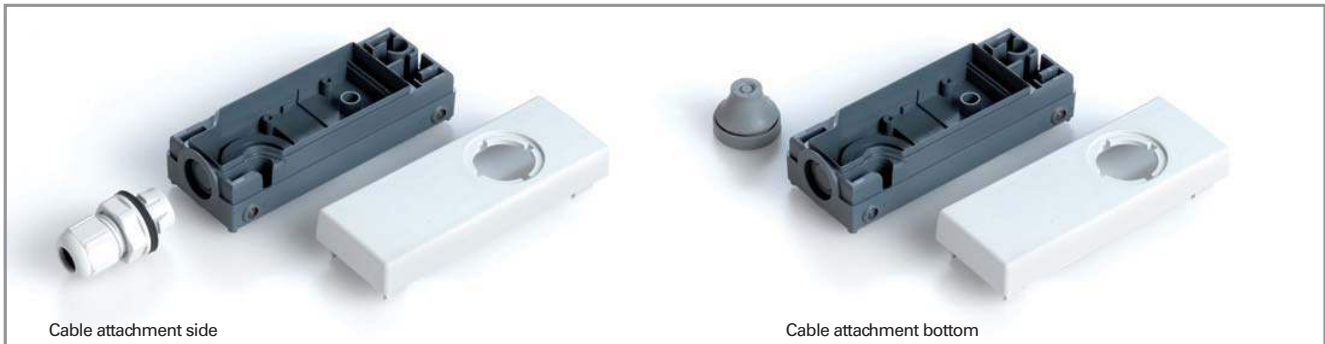

E-BOX housing	Cable attachment	Colour of top	Order no.
housing	side M16	grey	1.20.810.303/0000
housing	bottom M20	grey	1.20.810.305/0000

Dimensional drawing see page 3/5.

Pushbutton* RAFIX 22 FS

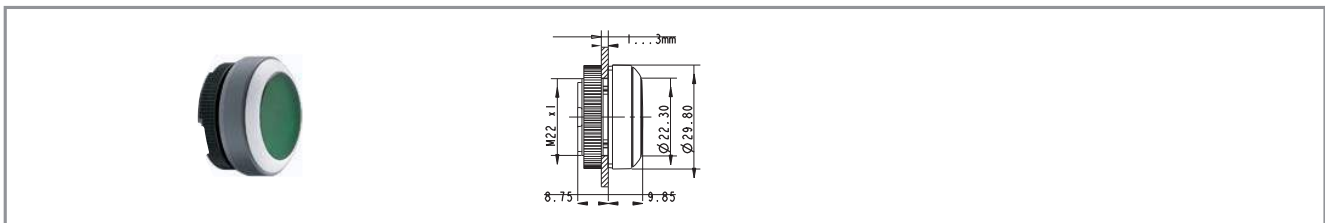

Illuminated	Lens colour	Order no. for momentary contact type		Order no. for latching contact type	
		Plastic front ring	Metallized front ring	Plastic front ring	Metallized front ring
yes	transparent white	1.30.250.001/10xx	1.30.250.021/1000	1.30.250.011/10xx	1.30.250.031/1000
yes	transparent red	1.30.250.001/13xx	1.30.250.021/1300	1.30.250.011/13xx	1.30.250.031/1300
yes	transparent yellow	1.30.250.001/14xx	1.30.250.021/1400	1.30.250.011/14xx	1.30.250.031/1400
yes	transparent green	1.30.250.001/15xx	1.30.250.021/1500	1.30.250.011/15xx	1.30.250.031/1500
yes	transparent blue	1.30.250.001/16xx	1.30.250.021/1600	1.30.250.011/16xx	1.30.250.031/1600

xx = Front ring colour: black = 01, red = 03, yellow = 04, green = 05, blue = 06, slate grey = 07, silver grey = 08
 Legending on request.

For more pushbutton models, see the RAFI catalogue „Electromechanical Components“; chapter RAFIX 22 FS.

* Applications with other actuators from the RAFIX 22 FS series are possible on request.

E-Box contact modules for standard applications



E-Box contact module	RAFIX 22 FS	Contact material	Contacts	LED / colour	Order no.
contact module	Universal	gold	2 NC	none	5.00 100.228/0000
contact module	Universal	gold	2 NC	LED red	5.00 100.229/0000
contact module	Universal	gold	2 NC	LED yellow	5.00 100.230/0000
contact module	Universal	gold	2 NC	LED green	5.00 100.231/0000
contact module	Universal	gold	2 NC	LED blue	5.00 100.232/0000
contact module	Universal	gold	2 NC	LED white	5.00 100.233/0000
contact module	Universal	gold	1 NC + 1 NO	none	5.00 100.234/0000
contact module	Universal	gold	1 NC + 1 NO	LED red	5.00 100.235/0000
contact module	Universal	gold	1 NC + 1 NO	LED yellow	5.00 100.236/0000
contact module	Universal	gold	1 NC + 1 NO	LED green	5.00 100.237/0000
contact module	Universal	gold	1 NC + 1 NO	LED blue	5.00 100.238/0000
contact module	Universal	gold	1 NC + 1 NO	LED white	5.00 100.239/0000
contact module	Universal	gold	2 NO	none	5.00 100.240/0000
contact module	Universal	gold	2 NO	LED red	5.00 100.241/0000
contact module	Universal	gold	2 NO	LED yellow	5.00 100.242/0000
contact module	Universal	gold	2 NO	LED green	5.00 100.243/0000
contact module	Universal	gold	2 NO	LED blue	5.00 100.244/0000
contact module	Universal	gold	2 NO	LED white	5.00 100.245/0000
contact module	Universal	silver	2 NC	none	5.00 100.246/0000
contact module	Universal	silver	1 NC + 1 NO	none	5.00 100.247/0000
contact module	Universal	silver	2 NO	none	5.00 100.248/0000

For technical data see page 3.

E-Box application examples



Profile rails are widely used in machinery and plant, as they can be universally deployed in all kinds of stable structures. They are used in, among other areas, logistics and production, because they can cover large span lengths. Aluminium profile rails are also widely used in the chassis structure of assembly robotics, for CNC machines or automatic injection moulding machines, as well as in transport and conveyor systems. Industrial work and test benches are most often built using profile rails.

Certain profile designs in this world-wide range of structures are also suitable for safety fences. Depending on the profile, various different panes or wave mesh can be used.

The range of accessories for profile rails is generally very extensive and suitable for all kinds of applications.

The E-Box assembly concept is based on profile rails. However, the E-Box can also be mounted on other surfaces. You can use the metal clip, or screws for direct mounting, to attach the E-Box to cast iron, wood, plaster, concrete, and many other surfaces.