

DS90LV012A /DS90LT012A 3V LVDS Single CMOS Differential Line Receiver

Check for Samples: [DS90LT012A](#), [DS90LV012A](#)

FEATURES

- Compatible with ANSI TIA/EIA-644-A Standard
- >400 Mbps (200 MHz) switching rates
- 100 ps differential skew (typical)
- 3.5 ns maximum propagation delay
- Integrated line termination resistor (102Ω typical)
- Single 3.3V power supply design (2.7V to 3.6V range)
- Power down high impedance on LVDS inputs
- Accepts small swing (350 mV typical) differential signal levels
- LVDS receiver inputs accept LVDS/BLVDS/LVPECL inputs
- Supports open, short and terminated input fail-safe
- Pinout simplifies PCB layout
- Low Power Dissipation (10mW typical@ 3.3V static)
- SOT-23 5-lead package
- Leadless WSON-8 package (3x3 mm body size)
- Electrically similar to the DS90LV018A
- Fabricated with advanced CMOS process technology
- Industrial temperature operating range (–40°C to +85°C)

DESCRIPTION

The DS90LV012A and DS90LT012A are single CMOS differential line receivers designed for applications requiring ultra low power dissipation, low noise, and high data rates. The devices are designed to support data rates in excess of 400 Mbps (200 MHz) utilizing Low Voltage Differential Swing (LVDS) technology

The DS90LV012A and DS90LT012A accept low voltage (350 mV typical) differential input signals and translates them to 3V CMOS output levels. The receivers also support open, shorted, and terminated (100Ω) input fail-safe. The receiver output will be HIGH for all fail-safe conditions. The DS90LV012A has a pinout designed for easy PCB layout. The DS90LT012A includes an input line termination resistor for point-to-point applications.

The DS90LV012A and DS90LT012A, and companion LVDS line driver provide a new alternative to high power PECL/ECL devices for high speed interface applications.

Connection Diagram

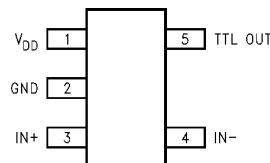

Figure 1. Top View
See Package Number DBV (R-PDSO-G5)



Please be aware that an important notice concerning availability, standard warranty, and use in critical applications of Texas Instruments semiconductor products and disclaimers thereto appears at the end of this data sheet.

All trademarks are the property of their respective owners.

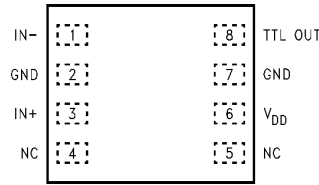

Figure 2. Top View
See Package Number NGK0008A

Functional Diagram

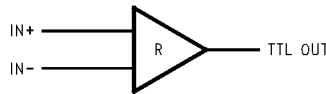

Figure 3. DS90LV012A

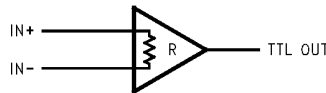

Figure 4. DS90LT012A

Truth Table

INPUTS	OUTPUT
[IN+] – [IN-]	TTL OUT
$V_{ID} \geq 0V$	H
$V_{ID} \leq -0.1V$	L
Full Fail-safe OPEN/SHORT or Terminated	H



These devices have limited built-in ESD protection. The leads should be shorted together or the device placed in conductive foam during storage or handling to prevent electrostatic damage to the MOS gates.

Absolute Maximum Ratings ⁽¹⁾

Supply Voltage (V_{DD})	-0.3V to +4V
Input Voltage (IN+, IN-)	-0.3V to +3.9V
Output Voltage (TTL OUT)	-0.3V to ($V_{DD} + 0.3V$)
Output Short Circuit Current	-100mA
Maximum Package Power Dissipation @ +25°C	
NGK Package	2.26 W
Derate NGK Package	18.1 mW/°C above +25°C
Thermal resistance (θ_{JA})	55.3°C/W
DBV Package	902mW
Derate DBV Package	7.22 mW/°C above +25°C
Thermal resistance (θ_{JA})	138.5°C/W
Storage Temperature Range	-65°C to +150°C
Lead Temperature Range Soldering (4 sec.)	+260°C
Maximum Junction Temperature	+150°C
ESD Ratings ⁽²⁾	

- (1) "Absolute Maximum Ratings" are those values beyond which the safety of the device cannot be ensured. They are not meant to imply that the devices should be operated at these limits. [Electrical Characteristics](#) specifies conditions of device operation.
- (2) ESD Ratings:
- (a) DS90LV012A:
 - (a) HBM (1.5 k Ω , 100 pF) \geq 2kV
 - (b) EIAJ (0 Ω , 200 pF) \geq 900V
 - (c) CDM \geq 2000V
 - (d) IEC direct (330 Ω , 150 pF) \geq 5kV
 - (b) DS90LT012A:
 - (a) HBM (1.5 k Ω , 100 pF) \geq 2kV
 - (b) EIAJ (0 Ω , 200 pF) \geq 700V
 - (c) CDM \geq 2000V
 - (d) IEC direct (330 Ω , 150 pF) \geq 7kV

Recommended Operating Conditions

	Min	Typ	Max	Units
Supply Voltage (V_{DD})	+2.7	+3.3	+3.6	V
Operating Free Air Temperature (T_A)	-40	25	+85	°C

Electrical Characteristics

Over Supply Voltage and Operating Temperature ranges, unless otherwise specified. ⁽¹⁾ ⁽²⁾

- (1) Current into device pins is defined as positive. Current out of device pins is defined as negative. All voltages are referenced to ground unless otherwise specified (such as V_{ID}).
- (2) All typicals are given for: $V_{DD} = +3.3V$ and $T_A = +25^\circ C$.

Electrical Characteristics (continued)

Over Supply Voltage and Operating Temperature ranges, unless otherwise specified. ⁽¹⁾ ⁽²⁾

Symbol	Parameter	Conditions	Pin	Min	Typ	Max	Units	
V_{TH}	Differential Input High Threshold	V_{CM} dependant on V_{DD} ⁽³⁾	IN+, IN-		-30	0	mV	
V_{TL}	Differential Input Low Threshold			-100	-30		mV	
V_{CM}	Common-Mode Voltage	$V_{DD} = 2.7V, V_{ID} = 100mV$		0.05		2.35	V	
		$V_{DD} = 3.0V$ to $3.6V, V_{ID} = 100mV$		0.05		$V_{DD} - 0.3V$	V	
I_{IN}	Input Current (DS90LV012A)	$V_{IN} = +2.8V$		$V_{DD} = 3.6V$ or $0V$	-10	± 1	+10	μA
		$V_{IN} = 0V$			-10	± 1	+10	μA
		$V_{IN} = +3.6V$			$V_{DD} = 0V$	-20		+20
ΔI_{IN}	Change in Magnitude of I_{IN}	$V_{IN} = +2.8V$		$V_{DD} = 3.6V$ or $0V$		4		μA
		$V_{IN} = 0V$				4		μA
		$V_{IN} = +3.6V$			$V_{DD} = 0V$		4	
I_{IND}	Differential Input Current	$V_{IN+} = +0.4V, V_{IN-} = +0V$	TTL OUT	3	3.9	4.4	mA	
	(DS90LT012A)	$V_{IN+} = +2.4V, V_{IN-} = +2.0V$						
R_T	Integrated Termination Resistor (DS90LT012A)					102		Ω
C_{IN}	Input Capacitance	$IN+ = IN- = GND$				3		pF
V_{OH}	Output High Voltage	$I_{OH} = -0.4 mA, V_{ID} = +200 mV$		2.4	3.1		V	
		$I_{OH} = -0.4 mA$, Inputs terminated		2.4	3.1		V	
		$I_{OH} = -0.4 mA$, Inputs shorted		2.4	3.1		V	
V_{OL}	Output Low Voltage	$I_{OL} = 2 mA, V_{ID} = -200 mV$			0.3	0.5	V	
I_{OS}	Output Short Circuit Current	$V_{OUT} = 0V$ ⁽⁴⁾			-15	-50	-100	mA
V_{CL}	Input Clamp Voltage	$I_{CL} = -18 mA$			-1.5	-0.7		V
I_{DD}	No Load Supply Current	Inputs Open	V_{DD}		5.4	9	mA	

(3) V_{DD} is always higher than IN+ and IN- voltage. IN+ and IN- are allowed to have voltage range $-0.05V$ to $+2.35V$ when $V_{DD} = 2.7V$ and $|V_{ID}| / 2$ to $V_{DD} - 0.3V$ when $V_{DD} = 3.0V$ to $3.6V$. V_{ID} is not allowed to be greater than $100 mV$ when $V_{CM} = 0.05V$ to $2.35V$ when $V_{DD} = 2.7V$ or when $V_{CM} = |V_{ID}| / 2$ to $V_{DD} - 0.3V$ when $V_{DD} = 3.0V$ to $3.6V$.

(4) Output short circuit current (I_{OS}) is specified as magnitude only, minus sign indicates direction only. Only one output should be shorted at a time, do not exceed maximum junction temperature specification.

Switching Characteristics

Over Supply Voltage and Operating Temperature ranges, unless otherwise specified. ⁽¹⁾ ⁽²⁾

Symbol	Parameter	Conditions	Min	Typ	Max	Units
t_{PHLD}	Differential Propagation Delay High to Low	$C_L = 15 \text{ pF}$	1.0	1.8	3.5	ns
t_{PLHD}	Differential Propagation Delay Low to High	$V_{ID} = 200 \text{ mV}$	1.0	1.7	3.5	ns
t_{SKD1}	Differential Pulse Skew $ t_{PHLD} - t_{PLHD} $ ⁽³⁾	(Figure 5 and Figure 6)	0	100	400	ps
t_{SKD3}	Differential Part to Part Skew ⁽⁴⁾		0	0.3	1.0	ns
t_{SKD4}	Differential Part to Part Skew ⁽⁵⁾		0	0.4	1.5	ns
t_{TLH}	Rise Time			350	800	ps
t_{THL}	Fall Time			175	800	ps
f_{MAX}	Maximum Operating Frequency ⁽⁶⁾		200	250		MHz

(1) C_L includes probe and jig capacitance.

(2) Generator waveform for all tests unless otherwise specified: $f = 1 \text{ MHz}$, $Z_O = 50\Omega$, t_r and t_f (0% to 100%) $\leq 3 \text{ ns}$ for IN_{\pm} .

(3) t_{SKD1} is the magnitude difference in differential propagation delay time between the positive-going-edge and the negative-going-edge of the same channel.

(4) t_{SKD3} , part to part skew, is the differential channel-to-channel skew of any event between devices. This specification applies to devices at the same V_{DD} and within 5°C of each other within the operating temperature range.

(5) t_{SKD4} , part to part skew, is the differential channel-to-channel skew of any event between devices. This specification applies to devices over the recommended operating temperature and voltage ranges, and across process distribution. t_{SKD4} is defined as $|Max - Min|$ differential propagation delay.

(6) f_{MAX} generator input conditions: $t_r = t_f < 1 \text{ ns}$ (0% to 100%), 50% duty cycle, differential (1.05V to 1.35 peak to peak). Output criteria: 60%/40% duty cycle, V_{OL} (max 0.4V), V_{OH} (min 2.4V), load = 15 pF (stray plus probes). The parameter is ensured by design. The limit is based on the statistical analysis of the device over the PVT range by the transition times (t_{TLH} and t_{THL}).

PARAMETER MEASUREMENT INFORMATION

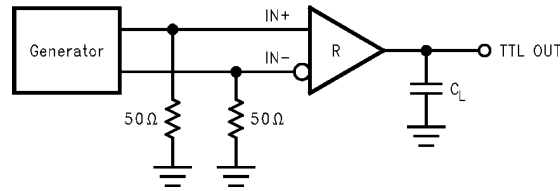

Figure 5. Receiver Propagation Delay and Transition Time Test Circuit

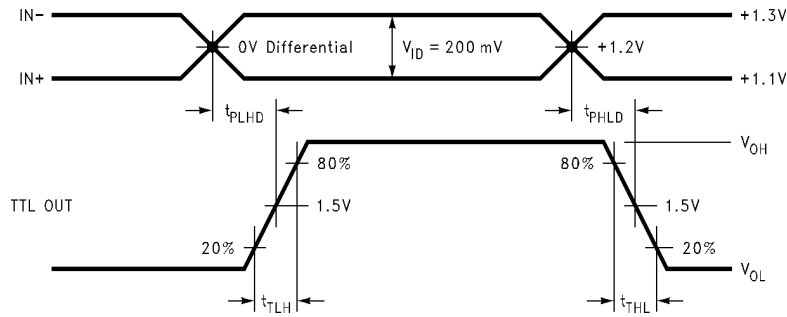

Figure 6. Receiver Propagation Delay and Transition Time Waveforms

TYPICAL APPLICATIONS

Balanced System

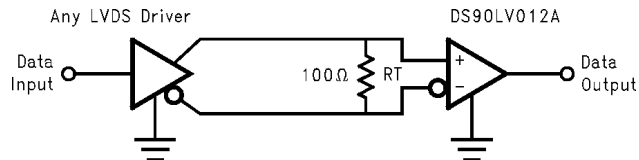

Figure 7. Point-to-Point Application (DS90LV012A)

Balanced System

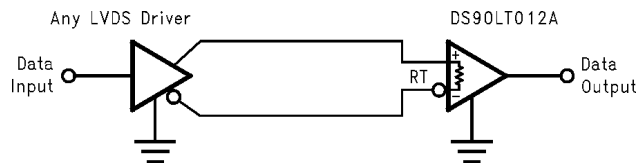

Figure 8. Point-to-Point Application (DS90LT012A)

APPLICATION INFORMATION

General application guidelines and hints for LVDS drivers and receivers may be found in the following application notes: LVDS Owner's Manual ([SNLA187](#)), AN-808 ([SNLA028](#)), AN-977 ([SNLA166](#)), AN-971 ([SNLA165](#)), AN-916 ([SNLA219](#)), AN-805 ([SNOA233](#)), AN-903 ([SNLA034](#)).

LVDS drivers and receivers are intended to be primarily used in an uncomplicated point-to-point configuration as is shown in [Figure 7](#). This configuration provides a clean signaling environment for the fast edge rates of the drivers. The receiver is connected to the driver through a balanced media which may be a standard twisted pair cable, a parallel pair cable, or simply PCB traces. Typically the characteristic impedance of the media is in the range of 100Ω. A termination resistor of 100Ω should be selected to match the media, and is located as close to the receiver input pins as possible. The termination resistor converts the driver output (current mode) into a voltage that is detected by the receiver. Other configurations are possible such as a multi-receiver configuration, but the effects of a mid-stream connector(s), cable stub(s), and other impedance discontinuities as well as ground shifting, noise margin limits, and total termination loading must be taken into account.

The DS90LV012A and DS90LT012A differential line receivers are capable of detecting signals as low as 100 mV, over a ±1V common-mode range centered around +1.2V. This is related to the driver offset voltage which is typically +1.2V. The driven signal is centered around this voltage and may shift ±1V around this center point. The ±1V shifting may be the result of a ground potential difference between the driver's ground reference and the receiver's ground reference, the common-mode effects of coupled noise, or a combination of the two. The AC parameters of both receiver input pins are optimized for a recommended operating input voltage range of 0V to +2.4V (measured from each pin to ground). The device will operate for receiver input voltages up to V_{DD} , but exceeding V_{DD} will turn on the ESD protection circuitry which will clamp the bus voltages.

POWER DECOUPLING RECOMMENDATIONS

Bypass capacitors must be used on power pins. Use high frequency ceramic (surface mount is recommended) 0.1μF and 0.001μF capacitors in parallel at the power supply pin with the smallest value capacitor closest to the device supply pin. Additional scattered capacitors over the printed circuit board will improve decoupling. Multiple vias should be used to connect the decoupling capacitors to the power planes. A 10μF (35V) or greater solid tantalum capacitor should be connected at the power entry point on the printed circuit board between the supply and ground.

PC BOARD CONSIDERATIONS

Use at least 4 PCB board layers (top to bottom): LVDS signals, ground, power, TTL signals.

Isolate TTL signals from LVDS signals, otherwise the TTL signals may couple onto the LVDS lines. It is best to put TTL and LVDS signals on different layers which are isolated by a power/ground plane(s).

Keep drivers and receivers as close to the (LVDS port side) connectors as possible.

For PC board considerations for the WSON package, please refer to application note AN-1187 "Leadless Leadframe Package" ([SNOA401](#)). It is important to note that to optimize signal integrity (minimize jitter and noise coupling), the WSON thermal land pad, which is a metal (normally copper) rectangular region located under the package, should be attached to ground and match the dimensions of the exposed pad on the PCB (1:1 ratio).

DIFFERENTIAL TRACES

Use controlled impedance traces which match the differential impedance of your transmission medium (ie. cable) and termination resistor. Run the differential pair trace lines as close together as possible as soon as they leave the IC (stubs should be < 10mm long). This will help eliminate reflections and ensure noise is coupled as common-mode. In fact, we have seen that differential signals which are 1mm apart radiate far less noise than traces 3mm apart since magnetic field cancellation is much better with the closer traces. In addition, noise induced on the differential lines is much more likely to appear as common-mode which is rejected by the receiver.

Match electrical lengths between traces to reduce skew. Skew between the signals of a pair means a phase difference between signals which destroys the magnetic field cancellation benefits of differential signals and EMI will result! (Note that the velocity of propagation, $v = c/E_r$ where c (the speed of light) = 0.2997mm/ps or 0.0118 in/ps). Do not rely solely on the autoroute function for differential traces. Carefully review dimensions to match differential impedance and provide isolation for the differential lines. Minimize the number of vias and other discontinuities on the line.

Avoid 90° turns (these cause impedance discontinuities). Use arcs or 45° bevels.

Within a pair of traces, the distance between the two traces should be minimized to maintain common-mode rejection of the receivers. On the printed circuit board, this distance should remain constant to avoid discontinuities in differential impedance. Minor violations at connection points are allowable.

TERMINATION

DS90LV012A:

Use a termination resistor which best matches the differential impedance or your transmission line. The resistor should be between 90Ω and 130Ω. Remember that the current mode outputs need the termination resistor to generate the differential voltage. LVDS will not work without resistor termination. Typically, connecting a single resistor across the pair at the receiver end will suffice.

Surface mount 1% - 2% resistors are the best. PCB stubs, component lead, and the distance from the termination to the receiver inputs should be minimized. The distance between the termination resistor and the receiver should be < 10mm (12mm MAX).

DS90LT012A:

The DS90LT012A integrates the terminating resistor for point-to-point applications. The resistor value will be between 90Ω and 133Ω.

THRESHOLD

The LVDS Standard (ANSI/TIA/EIA-644-A) specifies a maximum threshold of ±100mV for the LVDS receiver. The DS90LV012A and DS90LT012A support an enhanced threshold region of -100mV to 0V. This is useful for fail-safe biasing. The threshold region is shown in the Voltage Transfer Curve (VTC) in Figure 9. The typical DS90LV012A or DS90LT012A LVDS receiver switches at about -30mV. Note that with $V_{ID} = 0V$, the output will be in a HIGH state. With an external fail-safe bias of +25mV applied, the typical differential noise margin is now the difference from the switch point to the bias point. In the example below, this would be 55mV of Differential Noise Margin (+25mV - (-30mV)). With the enhanced threshold region of -100mV to 0V, this small external fail-safe biasing of +25mV (with respect to 0V) gives a DNM of a comfortable 55mV. With the standard threshold region of ±100mV, the external fail-safe biasing would need to be +25mV with respect to +100mV or +125mV, giving a DNM of 155mV which is stronger fail-safe biasing than is necessary for the DS90LV012A or DS90LT012A. If more DNM is required, then a stronger fail-safe bias point can be set by changing resistor values.

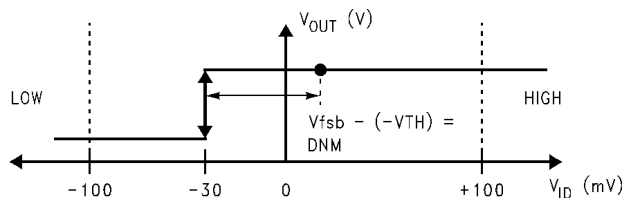

Figure 9. VTC of the DS90LV012A and DS90LT012A LVDS Receivers

FAIL-SAFE FEATURE

The LVDS receiver is a high gain, high speed device that amplifies a small differential signal (20mV) to CMOS logic levels. Due to the high gain and tight threshold of the receiver, care should be taken to prevent noise from appearing as a valid signal.

The receiver's internal fail-safe circuitry is designed to source/sink a small amount of current, providing fail-safe protection (a stable known state of HIGH output voltage) for floating, terminated or shorted receiver inputs.

1. **Open Input Pins.** The DS90LV012A and DS90LT012A are single receiver devices. It is not required to tie the receiver inputs to ground or any supply voltage. Internal failsafe circuitry will ensure a HIGH, stable output state for open inputs.
2. **Terminated Input.** If the driver is disconnected (cable unplugged), or if the driver is in a power-off condition, the receiver output will again be in a HIGH state, even with the end of cable 100Ω termination resistor across the input pins. The unplugged cable can become a floating antenna which can pick up noise. If the cable picks up more than 10mV of differential noise, the receiver may see the noise as a valid signal and switch. To insure that any noise is seen as common-mode and not differential, a balanced interconnect should be used. Twisted pair cable will offer better balance than flat ribbon cable.
3. **Shorted Inputs.** If a fault condition occurs that shorts the receiver inputs together, thus resulting in a 0V differential input voltage, the receiver output will remain in a HIGH state. Shorted input fail-safe is not supported across the common-mode range of the device (GND to 2.4V). It is only supported with inputs shorted and no external common-mode voltage applied.

External lower value pull up and pull down resistors (for a stronger bias) may be used to boost fail-safe in the presence of higher noise levels. The pull up and pull down resistors should be in the 5kΩ to 15kΩ range to minimize loading and waveform distortion to the driver. The common-mode bias point should be set to approximately 1.2V (less than 1.75V) to be compatible with the internal circuitry.

The DS90LV012A and DS90LT012A are compliant to the original ANSI EIA/TIA-644 specification and is also compliant to the new ANSI EIA/TIA-644-A specification with the exception the newly added ΔI_{IN} specification. Due to the internal fail-safe circuitry, ΔI_{IN} cannot meet the 6μA maximum specified. This exception will not be relevant unless more than 10 receivers are used.

Additional information on fail-safe biasing of LVDS devices may be found in AN-1194 ([SNLA051](#)).

PROBING LVDS TRANSMISSION LINES

Always use high impedance (> 100kΩ), low capacitance (< 2 pF) scope probes with a wide bandwidth (1 GHz) scope. Improper probing will give deceiving results.

CABLES AND CONNECTORS, GENERAL COMMENTS

When choosing cable and connectors for LVDS it is important to remember:

Use controlled impedance media. The cables and connectors you use should have a matched differential impedance of about 100Ω. They should not introduce major impedance discontinuities.

Balanced cables (e.g. twisted pair) are usually better than unbalanced cables (ribbon cable, simple coax) for noise reduction and signal quality. Balanced cables tend to generate less EMI due to field canceling effects and also tend to pick up electromagnetic radiation a common-mode (not differential mode) noise which is rejected by the receiver.

For cable distances < 0.5M, most cables can be made to work effectively. For distances $0.5M \leq d \leq 10M$, CAT 3 (category 3) twisted pair cable works well, is readily available and relatively inexpensive.

Pin Functions

Pin Descriptions

Package Pin Number		Pin Name	Description
SOT-23	WSON		
4	1	IN-	Inverting receiver input pin
3	3	IN+	Non-inverting receiver input pin
5	8	TTL OUT	Receiver output pin
1	6	V _{DD}	Power supply pin, +3.3V ± 0.3V
2	2, 7	GND	Ground pin
	4, 5	NC	No connect

REVISION HISTORY

Changes from Revision C (April 2013) to Revision D	Page
<hr/> <ul style="list-style-type: none">• Changed layout of National Data Sheet to TI format	<hr/> 10

PACKAGING INFORMATION

Orderable Device	Status (1)	Package Type	Package Drawing	Pins	Package Qty	Eco Plan (2)	Lead/Ball Finish (6)	MSL Peak Temp (3)	Op Temp (°C)	Device Marking (4/5)	Samples
DS90LT012ATMF	NRND	SOT-23	DBV	5	1000	TBD	Call TI	Call TI	-40 to 85	N03	
DS90LT012ATMF/NOPB	ACTIVE	SOT-23	DBV	5	1000	Green (RoHS & no Sb/Br)	SN	Level-1-260C-UNLIM	-40 to 85	N03	Samples
DS90LV012ATMF	NRND	SOT-23	DBV	5	1000	TBD	Call TI	Call TI	-40 to 85	N02	
DS90LV012ATMF/NOPB	ACTIVE	SOT-23	DBV	5	1000	Green (RoHS & no Sb/Br)	SN	Level-1-260C-UNLIM	-40 to 85	N02	Samples
DS90LV012ATMFX/NOPB	ACTIVE	SOT-23	DBV	5	3000	Green (RoHS & no Sb/Br)	SN	Level-1-260C-UNLIM	-40 to 85	N02	Samples

(1) The marketing status values are defined as follows:

ACTIVE: Product device recommended for new designs.

LIFEBUY: TI has announced that the device will be discontinued, and a lifetime-buy period is in effect.

NRND: Not recommended for new designs. Device is in production to support existing customers, but TI does not recommend using this part in a new design.

PREVIEW: Device has been announced but is not in production. Samples may or may not be available.

OBSELETE: TI has discontinued the production of the device.

(2) **RoHS:** TI defines "RoHS" to mean semiconductor products that are compliant with the current EU RoHS requirements for all 10 RoHS substances, including the requirement that RoHS substance do not exceed 0.1% by weight in homogeneous materials. Where designed to be soldered at high temperatures, "RoHS" products are suitable for use in specified lead-free processes. TI may reference these types of products as "Pb-Free".

RoHS Exempt: TI defines "RoHS Exempt" to mean products that contain lead but are compliant with EU RoHS pursuant to a specific EU RoHS exemption.

Green: TI defines "Green" to mean the content of Chlorine (Cl) and Bromine (Br) based flame retardants meet JS709B low halogen requirements of <=1000ppm threshold. Antimony trioxide based flame retardants must also meet the <=1000ppm threshold requirement.

(3) MSL, Peak Temp. - The Moisture Sensitivity Level rating according to the JEDEC industry standard classifications, and peak solder temperature.

(4) There may be additional marking, which relates to the logo, the lot trace code information, or the environmental category on the device.

(5) Multiple Device Markings will be inside parentheses. Only one Device Marking contained in parentheses and separated by a "~" will appear on a device. If a line is indented then it is a continuation of the previous line and the two combined represent the entire Device Marking for that device.

(6) Lead/Ball Finish - Orderable Devices may have multiple material finish options. Finish options are separated by a vertical ruled line. Lead/Ball Finish values may wrap to two lines if the finish value exceeds the maximum column width.

Important Information and Disclaimer:The information provided on this page represents TI's knowledge and belief as of the date that it is provided. TI bases its knowledge and belief on information provided by third parties, and makes no representation or warranty as to the accuracy of such information. Efforts are underway to better integrate information from third parties. TI has taken and

continues to take reasonable steps to provide representative and accurate information but may not have conducted destructive testing or chemical analysis on incoming materials and chemicals. TI and TI suppliers consider certain information to be proprietary, and thus CAS numbers and other limited information may not be available for release.

In no event shall TI's liability arising out of such information exceed the total purchase price of the TI part(s) at issue in this document sold by TI to Customer on an annual basis.

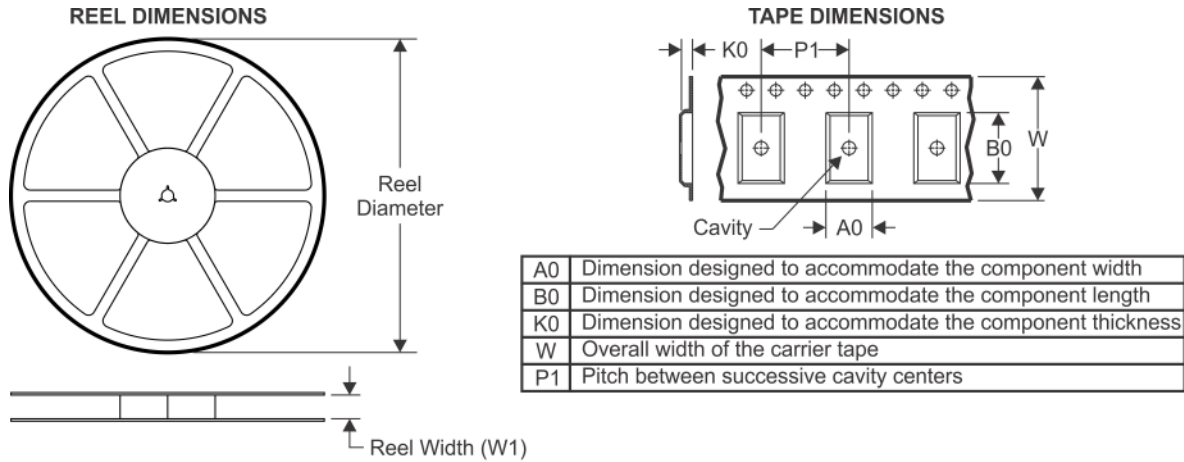
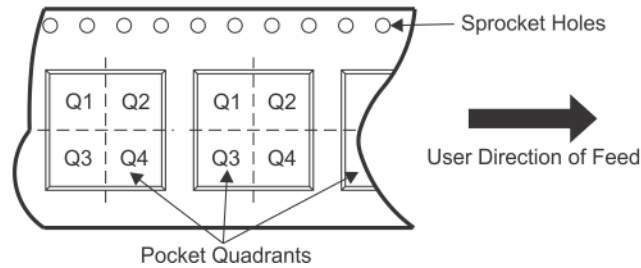
TAPE AND REEL INFORMATION

QUADRANT ASSIGNMENTS FOR PIN 1 ORIENTATION IN TAPE

*All dimensions are nominal

Device	Package Type	Package Drawing	Pins	SPQ	Reel Diameter (mm)	Reel Width W1 (mm)	A0 (mm)	B0 (mm)	K0 (mm)	P1 (mm)	W (mm)	Pin1 Quadrant
DS90LT012ATMF	SOT-23	DBV	5	1000	178.0	8.4	3.2	3.2	1.4	4.0	8.0	Q3
DS90LT012ATMF/NOPB	SOT-23	DBV	5	1000	178.0	8.4	3.2	3.2	1.4	4.0	8.0	Q3
DS90LV012ATMF	SOT-23	DBV	5	1000	178.0	8.4	3.2	3.2	1.4	4.0	8.0	Q3
DS90LV012ATMF/NOPB	SOT-23	DBV	5	1000	178.0	8.4	3.2	3.2	1.4	4.0	8.0	Q3
DS90LV012ATMFX/NOPB	SOT-23	DBV	5	3000	178.0	8.4	3.2	3.2	1.4	4.0	8.0	Q3

TAPE AND REEL BOX DIMENSIONS

*All dimensions are nominal

Device	Package Type	Package Drawing	Pins	SPQ	Length (mm)	Width (mm)	Height (mm)
DS90LT012ATMF	SOT-23	DBV	5	1000	210.0	185.0	35.0
DS90LT012ATMF/NOPB	SOT-23	DBV	5	1000	210.0	185.0	35.0
DS90LV012ATMF	SOT-23	DBV	5	1000	210.0	185.0	35.0
DS90LV012ATMF/NOPB	SOT-23	DBV	5	1000	210.0	185.0	35.0
DS90LV012ATMFX/NOPB	SOT-23	DBV	5	3000	210.0	185.0	35.0

DBV0005A



PACKAGE OUTLINE

SOT-23 - 1.45 mm max height

SMALL OUTLINE TRANSISTOR

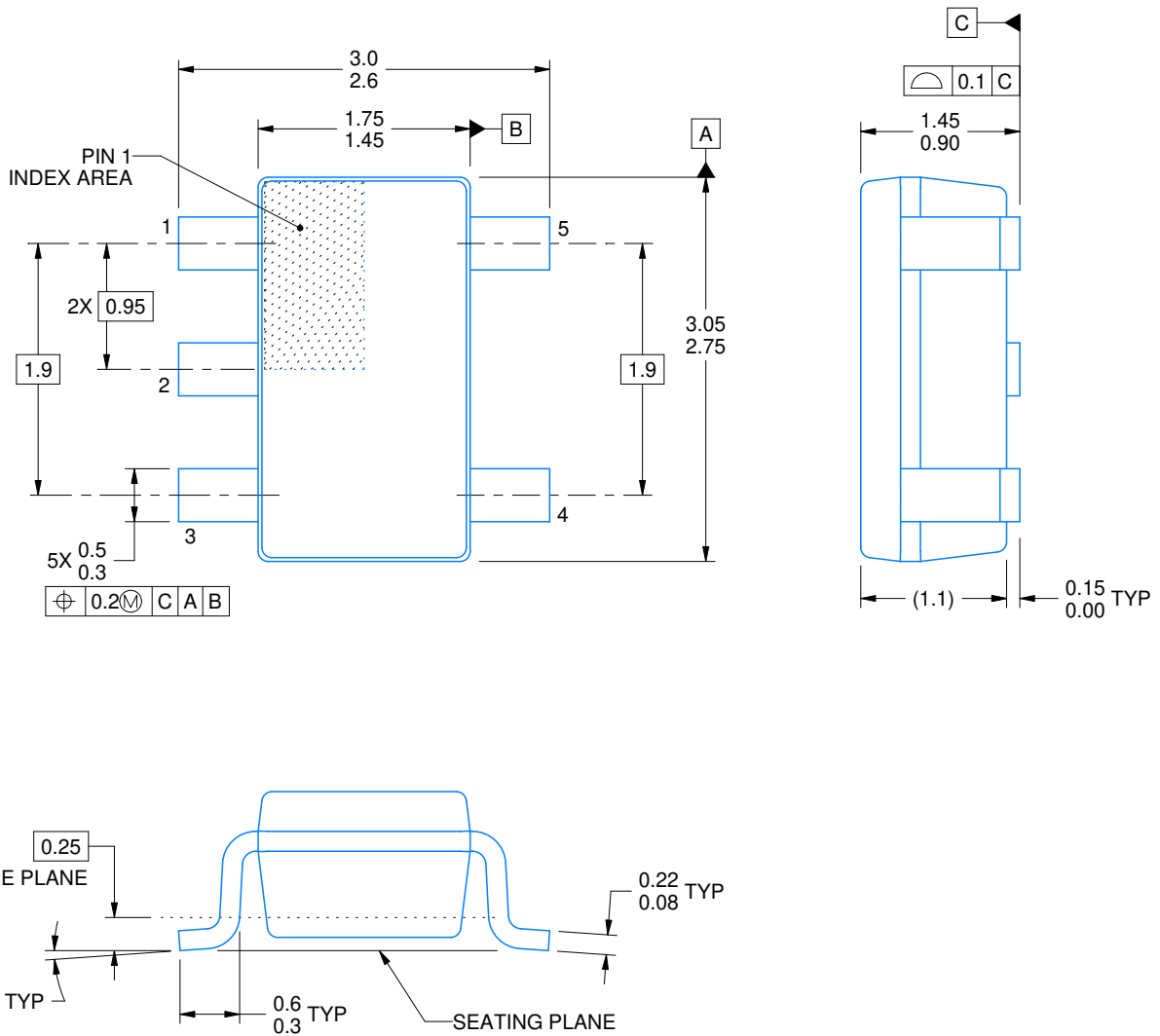

4214839/E 09/2019

NOTES:

1. All linear dimensions are in millimeters. Any dimensions in parenthesis are for reference only. Dimensioning and tolerancing per ASME Y14.5M.
2. This drawing is subject to change without notice.
3. Reference JEDEC MO-178.
4. Body dimensions do not include mold flash, protrusions, or gate burrs. Mold flash, protrusions, or gate burrs shall not exceed 0.15 mm per side.

EXAMPLE BOARD LAYOUT

DBV0005A

SOT-23 - 1.45 mm max height

SMALL OUTLINE TRANSISTOR

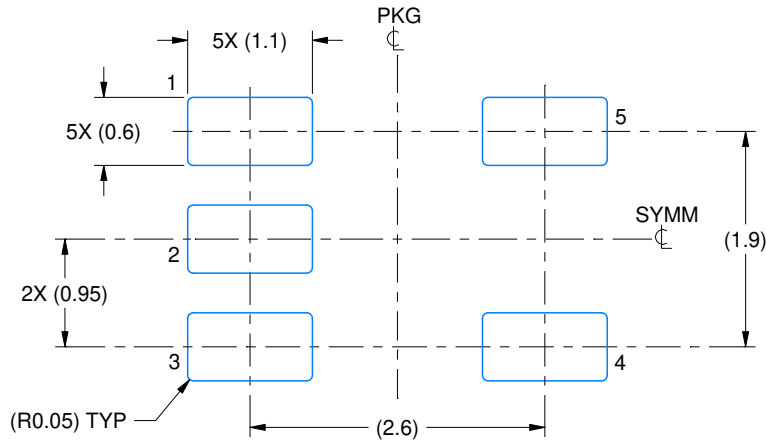

LAND PATTERN EXAMPLE
EXPOSED METAL SHOWN
SCALE:15X

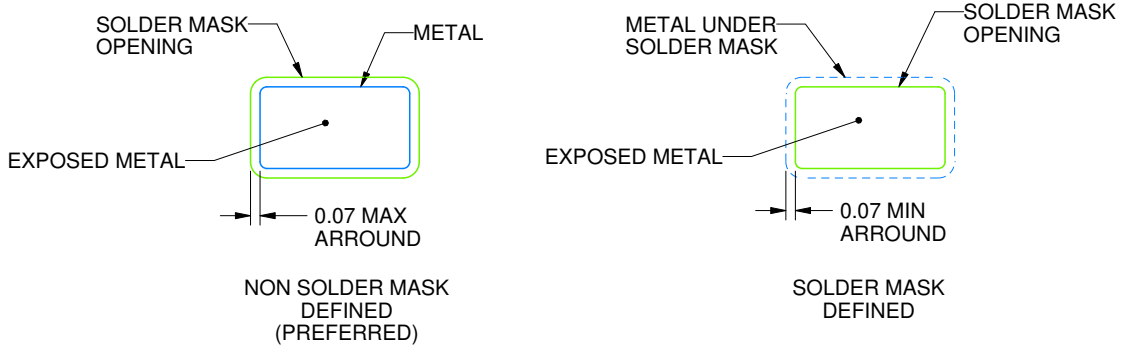

SOLDER MASK DETAILS

4214839/E 09/2019

NOTES: (continued)

- 5. Publication IPC-7351 may have alternate designs.
- 6. Solder mask tolerances between and around signal pads can vary based on board fabrication site.

EXAMPLE STENCIL DESIGN

DBV0005A

SOT-23 - 1.45 mm max height

SMALL OUTLINE TRANSISTOR

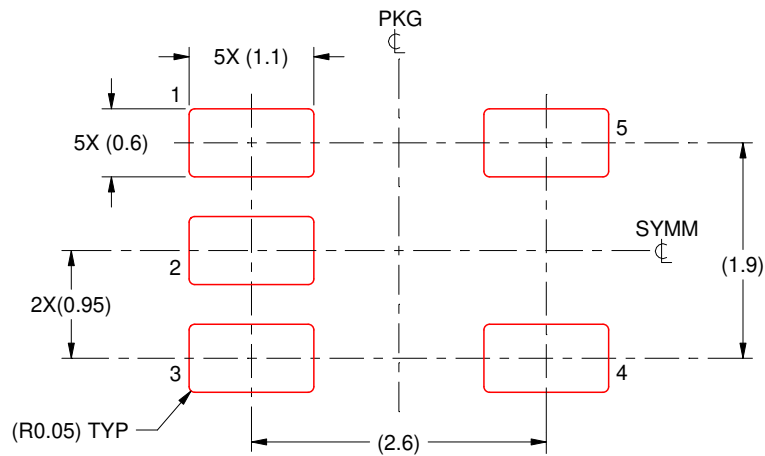

SOLDER PASTE EXAMPLE
BASED ON 0.125 mm THICK STENCIL
SCALE:15X

4214839/E 09/2019

NOTES: (continued)

7. Laser cutting apertures with trapezoidal walls and rounded corners may offer better paste release. IPC-7525 may have alternate design recommendations.
8. Board assembly site may have different recommendations for stencil design.

IMPORTANT NOTICE AND DISCLAIMER

TI PROVIDES TECHNICAL AND RELIABILITY DATA (INCLUDING DATASHEETS), DESIGN RESOURCES (INCLUDING REFERENCE DESIGNS), APPLICATION OR OTHER DESIGN ADVICE, WEB TOOLS, SAFETY INFORMATION, AND OTHER RESOURCES "AS IS" AND WITH ALL FAULTS, AND DISCLAIMS ALL WARRANTIES, EXPRESS AND IMPLIED, INCLUDING WITHOUT LIMITATION ANY IMPLIED WARRANTIES OF MERCHANTABILITY, FITNESS FOR A PARTICULAR PURPOSE OR NON-INFRINGEMENT OF THIRD PARTY INTELLECTUAL PROPERTY RIGHTS.

These resources are intended for skilled developers designing with TI products. You are solely responsible for (1) selecting the appropriate TI products for your application, (2) designing, validating and testing your application, and (3) ensuring your application meets applicable standards, and any other safety, security, or other requirements. These resources are subject to change without notice. TI grants you permission to use these resources only for development of an application that uses the TI products described in the resource. Other reproduction and display of these resources is prohibited. No license is granted to any other TI intellectual property right or to any third party intellectual property right. TI disclaims responsibility for, and you will fully indemnify TI and its representatives against, any claims, damages, costs, losses, and liabilities arising out of your use of these resources.

TI's products are provided subject to TI's Terms of Sale (www.ti.com/legal/termsofsale.html) or other applicable terms available either on ti.com or provided in conjunction with such TI products. TI's provision of these resources does not expand or otherwise alter TI's applicable warranties or warranty disclaimers for TI products.

Mailing Address: Texas Instruments, Post Office Box 655303, Dallas, Texas 75265
Copyright © 2020, Texas Instruments Incorporated