

## 2A, 40V - 200V Schottky Barrier Surface Mount Rectifier

### FEATURES

- AEC-Q101 qualified
- Low power loss, high efficiency
- Ideal for automated placement
- High surge current capability
- Moisture sensitivity level: level 1, per J-STD-020
- RoHS Compliant
- Halogen-free according to IEC 61249-2-21

### APPLICATIONS

- Switching mode power supply (SMPS)
- Adapters
- Lighting application
- On-board DC/DC converter

### MECHANICAL DATA

- Case: SOD-128
- Molding compound meets UL 94V-0 flammability rating
- Terminal: Matte tin plated leads, solderable per J-STD-002
- Meet JESD 201 class 2 whisker test
- Polarity: Indicated by cathode band
- Weight: 0.028g (approximately)

KEY PARAMETERS		
PARAMETER	VALUE	UNIT
$I_F$	2	A
$V_{RRM}$	40 - 200	V
$I_{FSM}$	50	A
$T_{JMAX}$	150	°C
Package	SOD-128	
Configuration	Single die	

**SOD-128**

ABSOLUTE MAXIMUM RATINGS ( $T_A = 25^\circ\text{C}$ unless otherwise noted)							
PARAMETER	SYMBOL	SS24 FSH	SS26 FSH	SS210 FSH	SS215 FSH	SS220 FSH	UNIT
Marking code on the device		24FSH	26FSH	210FSH	215FSH	220FSH	
Repetitive peak reverse voltage	$V_{RRM}$	40	60	100	150	200	V
Reverse voltage, total rms value	$V_{R(RMS)}$	28	42	70	105	140	V
Forward current	$I_F$	2					A
Surge peak forward current, single half sine-wave superimposed on rated load	$t = 8.3\text{ms}$	50					A
	$t = 1.0\text{ms}$	145					A
Junction temperature	$T_J$	-55 to +150					°C
Storage temperature	$T_{STG}$	-55 to +150					°C

<b>THERMAL PERFORMANCE</b>			
<b>PARAMETER</b>	<b>SYMBOL</b>	<b>TYP</b>	<b>UNIT</b>
Junction-to-lead thermal resistance	$R_{\theta JL}$	18	°C/W
Junction-to-ambient thermal resistance	$R_{\theta JA}$	75	°C/W
Junction-to-case thermal resistance	$R_{\theta JC}$	16	°C/W

**Thermal Performance Note:** Units mounted on PCB (5mm x 5mm Cu pad test board)

<b>ELECTRICAL SPECIFICATIONS</b> ( $T_A = 25^\circ\text{C}$ unless otherwise noted)						
<b>PARAMETER</b>		<b>CONDITIONS</b>	<b>SYMBOL</b>	<b>TYP</b>	<b>MAX</b>	<b>UNIT</b>
Forward voltage <sup>(1)</sup>	SS24FSH	$I_F = 1\text{A}, T_J = 25^\circ\text{C}$	$V_F$	0.40	-	V
		$I_F = 2\text{A}, T_J = 25^\circ\text{C}$		0.46	0.57	V
		$I_F = 1\text{A}, T_J = 125^\circ\text{C}$		0.34	-	V
		$I_F = 2\text{A}, T_J = 125^\circ\text{C}$		0.40	0.56	V
	SS26FSH	$I_F = 1\text{A}, T_J = 25^\circ\text{C}$		0.50	-	V
		$I_F = 2\text{A}, T_J = 25^\circ\text{C}$		0.60	0.70	V
		$I_F = 1\text{A}, T_J = 125^\circ\text{C}$		0.44	-	V
		$I_F = 2\text{A}, T_J = 125^\circ\text{C}$		0.54	0.62	V
	SS210FSH	$I_F = 1\text{A}, T_J = 25^\circ\text{C}$		0.66	-	V
		$I_F = 2\text{A}, T_J = 25^\circ\text{C}$		0.76	0.85	V
		$I_F = 1\text{A}, T_J = 125^\circ\text{C}$		0.57	-	V
		$I_F = 2\text{A}, T_J = 125^\circ\text{C}$		0.62	0.76	V
	SS215FSH	$I_F = 1\text{A}, T_J = 25^\circ\text{C}$		0.75	-	V
		$I_F = 2\text{A}, T_J = 25^\circ\text{C}$		0.81	0.95	V
		$I_F = 1\text{A}, T_J = 125^\circ\text{C}$		0.61	-	V
		$I_F = 2\text{A}, T_J = 125^\circ\text{C}$		0.67	0.80	V
	SS220FSH	$I_F = 1\text{A}, T_J = 25^\circ\text{C}$		0.78	-	V
		$I_F = 2\text{A}, T_J = 25^\circ\text{C}$		0.84	0.95	V
		$I_F = 1\text{A}, T_J = 125^\circ\text{C}$		0.63	-	V
		$I_F = 2\text{A}, T_J = 125^\circ\text{C}$		0.71	0.89	V
Reverse current @ rated $V_R$ <sup>(2)</sup>	SS24FSH SS26FSH	$T_J = 25^\circ\text{C}$	$I_R$	-	200	$\mu\text{A}$
		$T_J = 125^\circ\text{C}$		-	40	mA
	SS210FSH SS215FSH SS220FSH	$T_J = 25^\circ\text{C}$		-	10	$\mu\text{A}$
		$T_J = 125^\circ\text{C}$		-	5	mA
Junction capacitance	SS24FSH	1MHz, $V_R = 4.0\text{V}$	$C_J$	124	-	pF
	SS26FSH			95	-	pF
	SS210FSH			61	-	pF
	SS215FSH			48	-	pF
	SS220FSH			39	-	pF

**Notes:**

1. Pulse test with  $PW = 0.3\text{ms}$
2. Pulse test with  $PW = 30\text{ms}$

<b>ORDERING INFORMATION</b>		
<b>ORDERING CODE<sup>(1)</sup></b>	<b>PACKAGE</b>	<b>PACKING</b>
SS2xFSH	SOD-128	14,000 / Tape & Reel

**Notes:**

1. "x" defines voltage from 40V(SS24FSH) to 200V(SS220FSH)

**CHARACTERISTICS CURVES**

( $T_A = 25^\circ\text{C}$  unless otherwise noted)

**Fig.1 Forward Current Derating Curve**

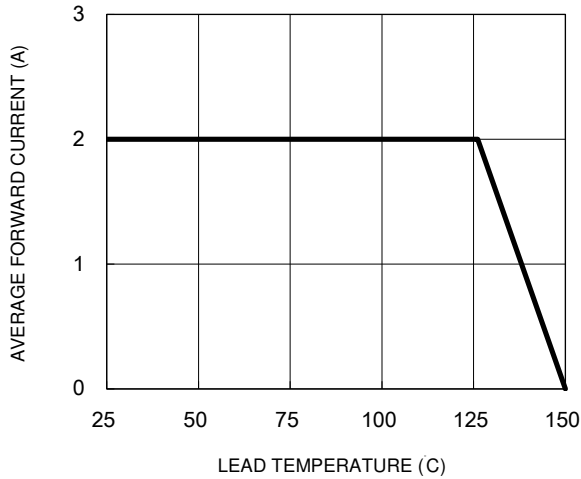

**Fig.2 Typical Junction Capacitance**

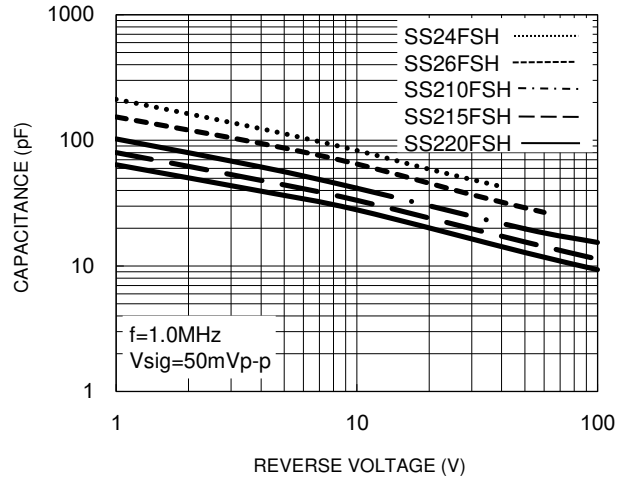

**Fig.3 Typical Reverse Characteristics**

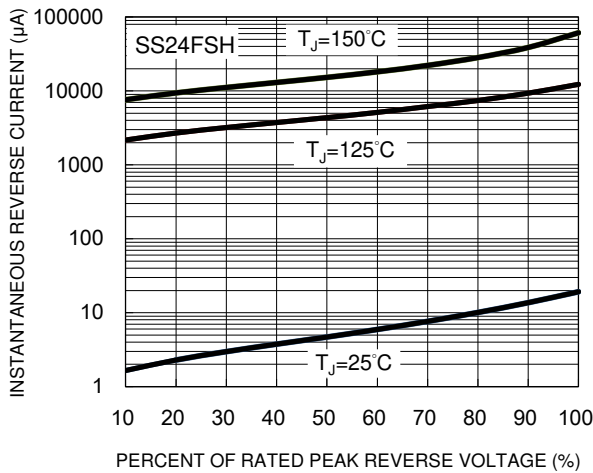

**Fig.4 Typical Forward Characteristics**

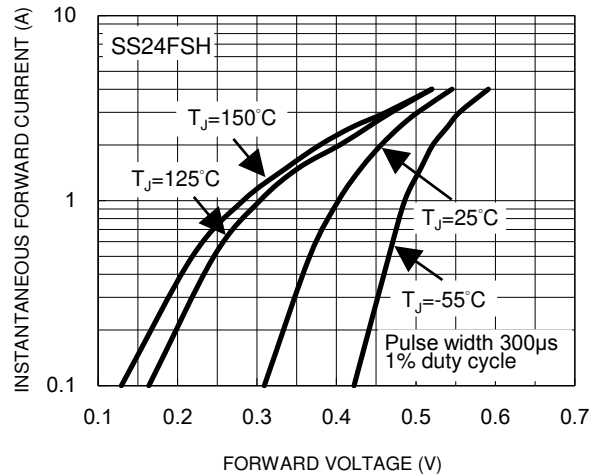

**Fig.5 Typical Reverse Characteristics**

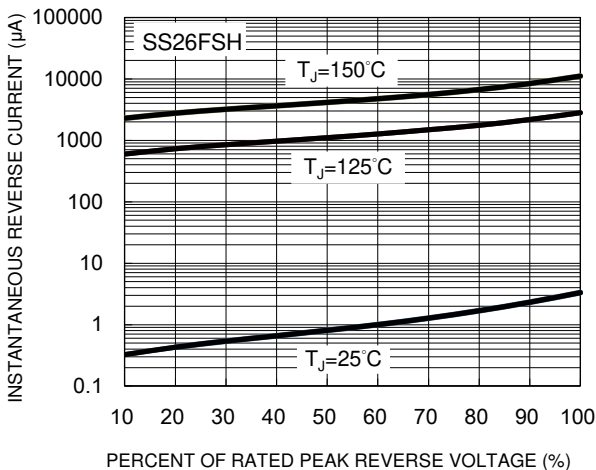

**Fig.6 Typical Forward Characteristics**

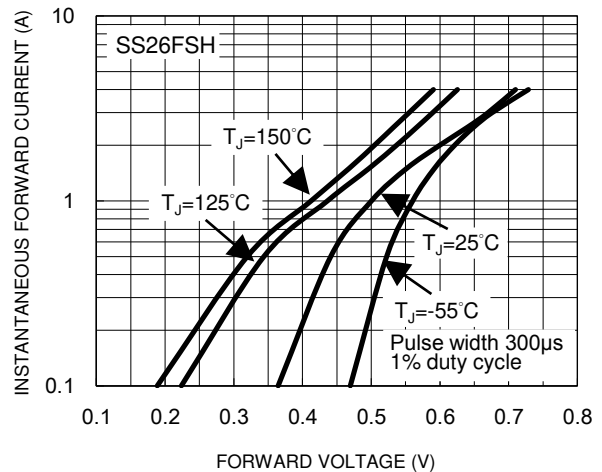

**CHARACTERISTICS CURVES**

( $T_A = 25^\circ\text{C}$  unless otherwise noted)

**Fig.7 Typical Reverse Characteristics**

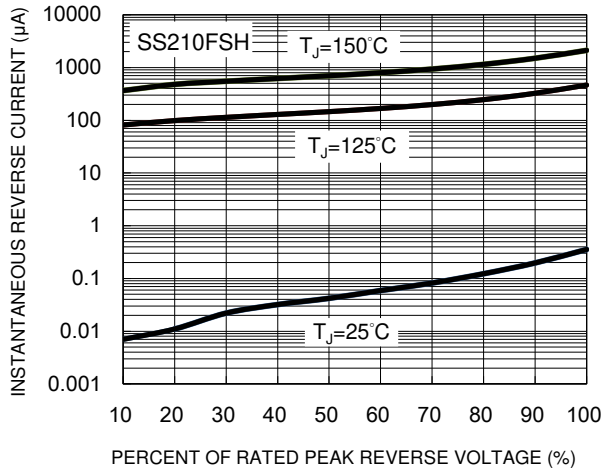

**Fig.9 Typical Reverse Characteristics**

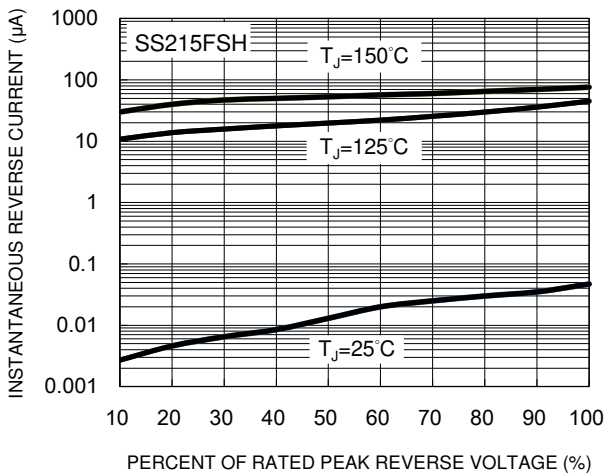

**Fig.11 Typical Reverse Characteristics**

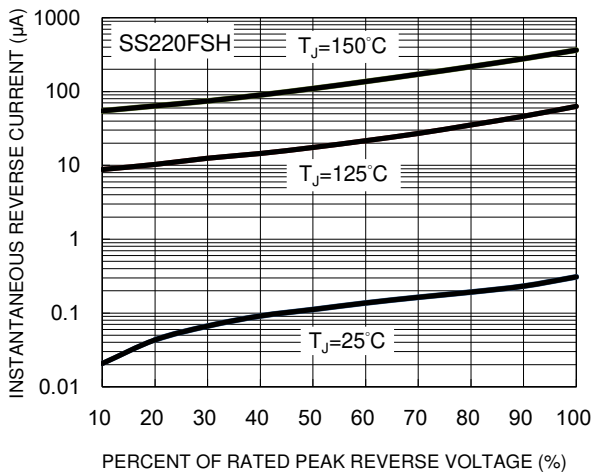

**Fig.8 Typical Forward Characteristics**

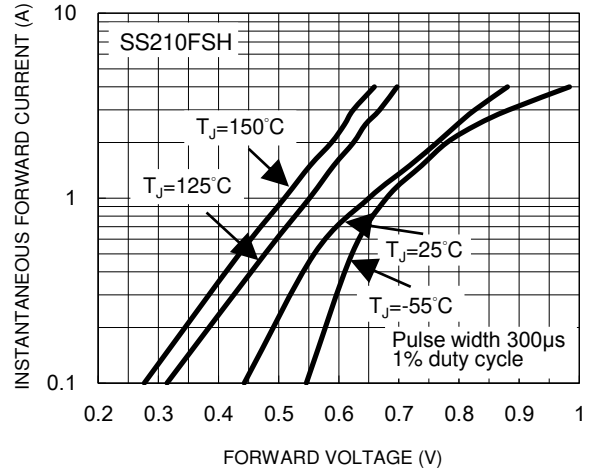

**Fig.10 Typical Forward Characteristics**

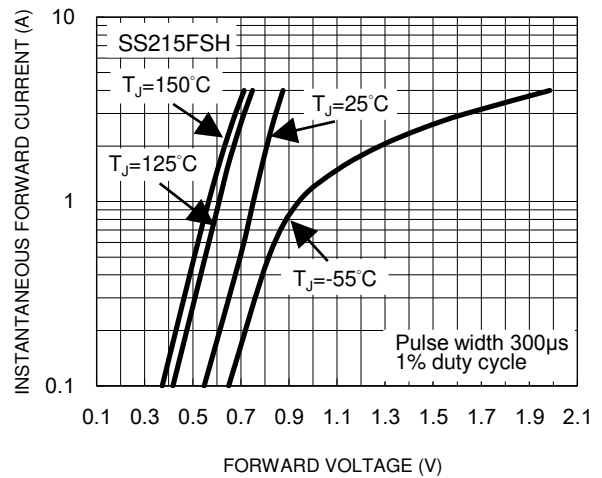

**Fig.12 Typical Forward Characteristics**

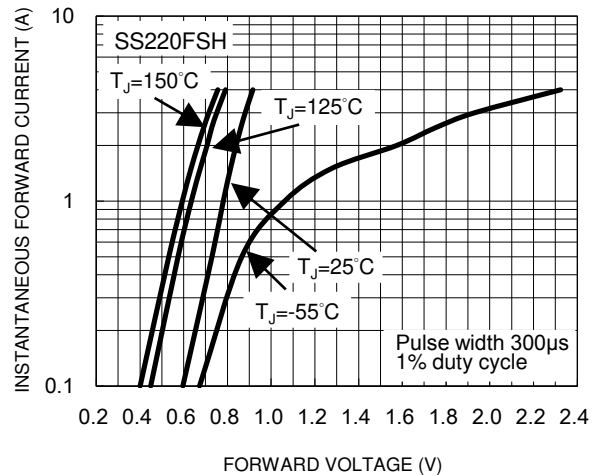

**CHARACTERISTICS CURVES**

( $T_A = 25^\circ\text{C}$  unless otherwise noted)

**Fig.13 Typical Transient Thermal Impedance**

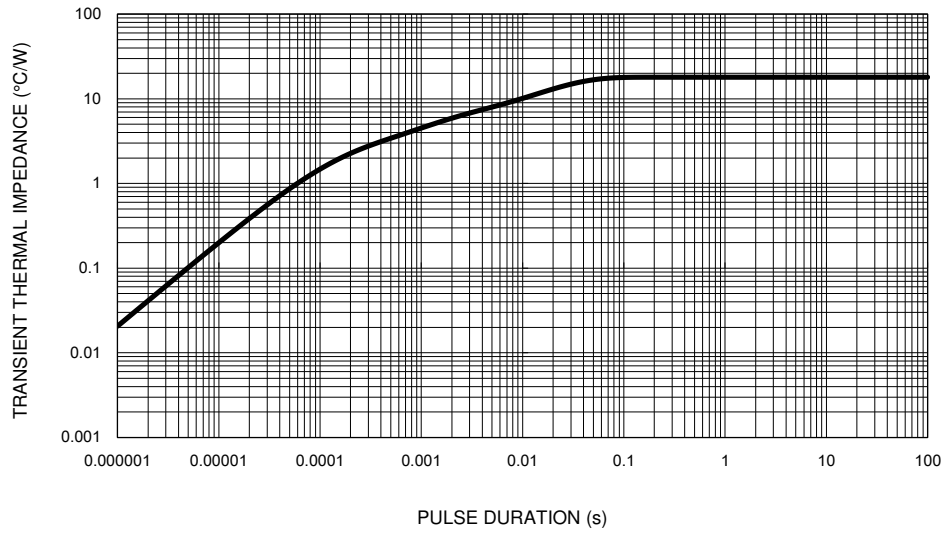

**PACKAGE OUTLINE DIMENSIONS**

SOD-128

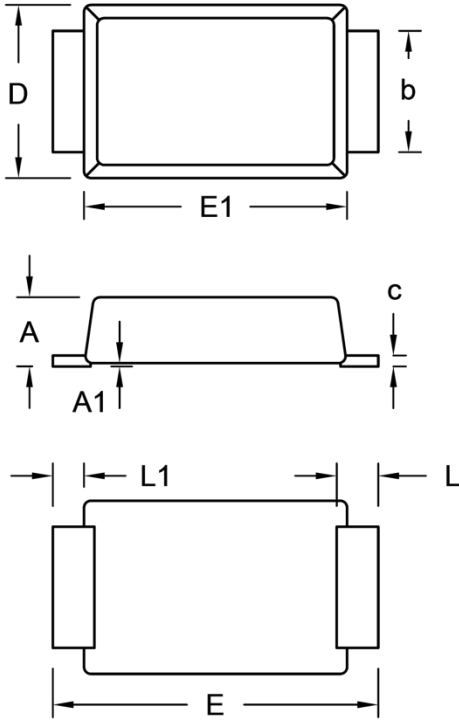

DIM.	Unit (mm)		Unit (inch)	
	Min.	Max.	Min.	Max.
A	0.90	1.10	0.035	0.043
A1	0.00	0.10	0.000	0.004
b	1.60	1.90	0.063	0.075
c	0.10	0.22	0.004	0.009
D	2.30	2.70	0.091	0.106
E	4.40	5.00	0.173	0.197
E1	3.60	4.00	0.142	0.157
L	0.40	0.80	0.016	0.031
L1	0.30	0.60	0.012	0.024

**SUGGESTED PAD LAYOUT**

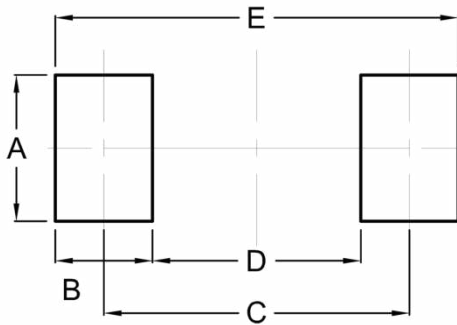

Symbol	Unit (mm)	Unit (inch)
A	2.10	0.083
B	1.40	0.055
C	4.40	0.173
D	3.00	0.118
E	5.80	0.228

**MARKING DIAGRAM**



- P/N = Marking Code
- YW = Date Code
- F = Factory Code

## **Notice**

Specifications of the products displayed herein are subject to change without notice. TSC or anyone on its behalf, assumes no responsibility or liability for any errors or inaccuracies.

Purchasers are solely responsible for the choice, selection, and use of TSC products and TSC assumes no liability for application assistance or the design of Purchasers' products.

Information contained herein is intended to provide a product description only. No license, express or implied, to any intellectual property rights is granted by this document. Except as provided in TSC's terms and conditions of sale for such products, TSC assumes no liability whatsoever, and disclaims any express or implied warranty, relating to sale and/or use of TSC products including liability or warranties relating to fitness for a particular purpose, merchantability, or infringement of any patent, copyright, or other intellectual property right.

The products shown herein are not designed for use in medical, life-saving, or life-sustaining applications. Customers using or selling these products for use in such applications do so at their own risk and agree to fully indemnify TSC for any damages resulting from such improper use or sale.