



DSA700 Series Spectrum Analyzer

- All-Digital IF Technology
- Frequency Range from 100 kHz up to 1 GHz
- Min. -130 dBm Displayed Average Noise Level (Typ.)
- Min. <-80 dBc/Hz @ 10 kHz Offset Phase Noise
- Level Measurement Uncertainty <1.5 dB
- 100 Hz Minimum Resolution Bandwidth
- Advanced Measurement Functions (Opt.)
- EMI Filter & Quasi-Peak Detector Kit (Opt.)
- PC Software (Opt.)
- Optional RF TX/RX Training Kit
- Optional RF Accessories (Cable, Adaptor, Attenuator ...)
- Complete Connectivity: LAN (LXI), USB Host & Device, GPIB (Opt.)
- 8 Inch WVGA (800×480) Display
- Compact Size, Light Weight Design

DSA700 Series Spectrum Analyzer



Product Dimensions: Width × Height × Depth = 361.6 mm × 178.8 mm × 128 mm

► Benefits of Rigol's all digital IF design

- The ability to measure smaller signals: on the basis of this technology, the IF filter enables smaller bandwidth settings, which greatly reduce the displayed average noise level.
- The ability to distinguish between small signals by frequency: using the IF filter with the smallest bandwidth setting, it is possible to make out signals with a frequency difference of only 100 Hz.
- High precision amplitude readings: this technology almost eliminates the errors generated by filter switching, reference level uncertainty, scale distortion, as well as errors produced in the process of switching between logarithmic and linear display of amplitude when using a traditional analog IF design.
- Higher reliability: compared with traditional analog designs, the digital IF greatly reduces the complexity of the hardware, the system instability caused by channel aging, and the temperature sensitivity that can contribute to parts failure.
- High measurement speed: the use of digital IF technology improves the bandwidth precision and selectivity of the filter, minimizing the scanning time and improving the speed of the measurement.

► Features and Benefits

Distinguish the two nearby signals clearly with the 100 Hz RBW

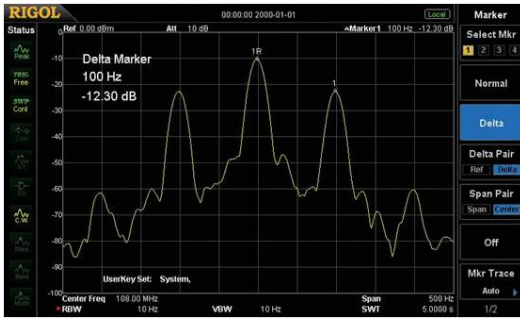

Compare the spectrums with different color trace

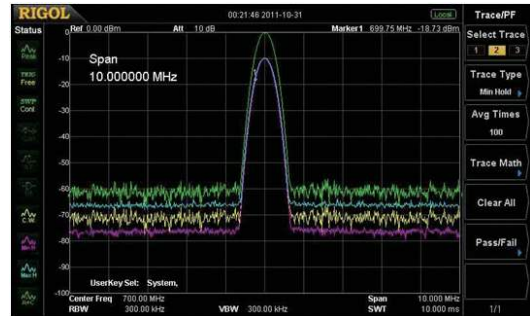

Readout the spectrum peak values with the peak table function

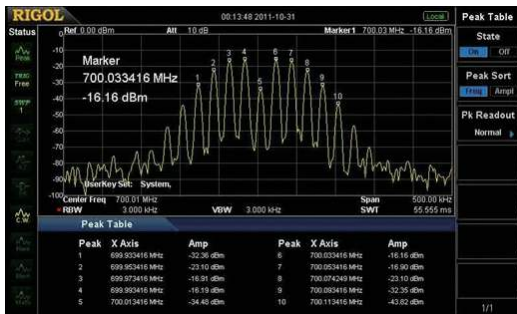

Measure lower level signal with the preamplifier turn on

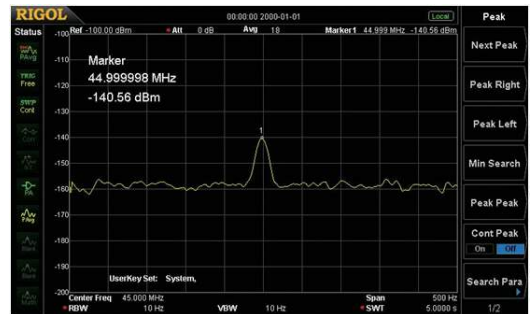

Phase noise < -80 dBc/Hz @10 kHz offset

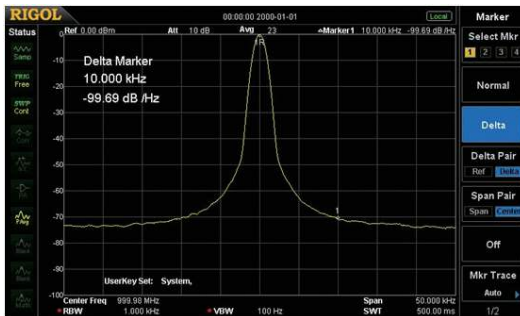

EMI kit (EMI filter & Quasi-peak & Pass/Fail)

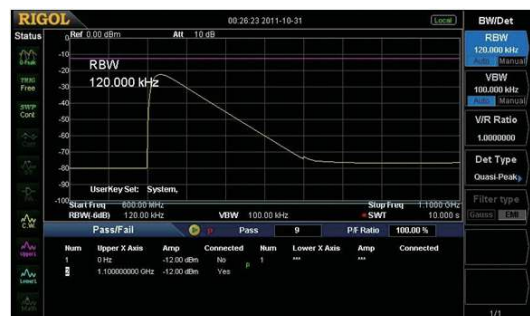

The GUI to control the RF demo kit (Transmitter) directly

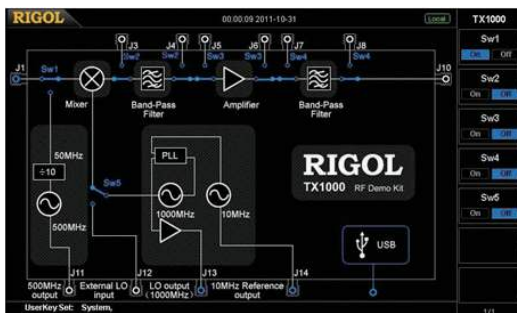

Zero span to demodulate the AM signal

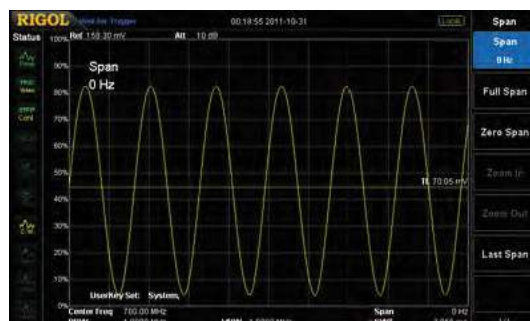

► RIGOL Spectrum Analyzer Option and Accessory

Harmonic Distortion	TOI	Emission Bandwidth
Channel Power	Occupied Bandwidth	
Time Domain Power	Carrier to Noise Ratio	
Adjacent Channel Power	Pass/Fail	

Advanced Measurement Kit
(AMK-DSA800)



Rack Mount Kit
(RM-DSA800)



Near Field Probe
(NFP-3)

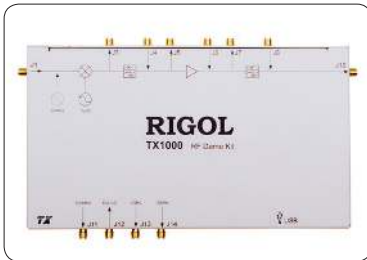

RF Demo Kit
(TX1000)

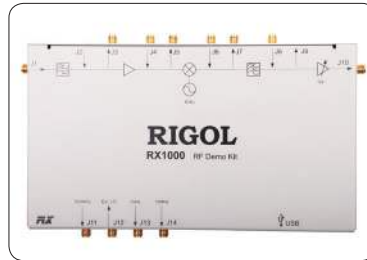

RF Demo Kit
(RX1000)



RF CATV Kit



DSA Utility Kit



RF Adaptor Kit



RF Attenuator Kit



RF Cable Kit
(CB-NM-NM-75-L-12G)
(CB-NM-SMAM-75-L-12G)



High Power Attenuator
(ATT03301H)

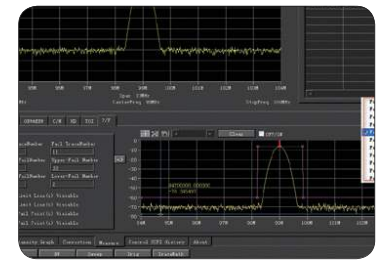

DSA PC Software
(Ultra Spectrum)



Soft Carrying Bag
(BAG-G1)



USB to GPIB Converter
(USB-GPIB)

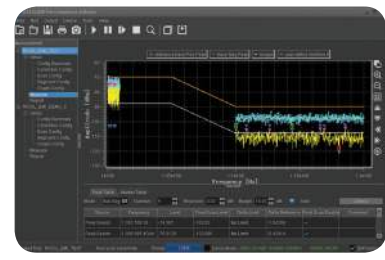

EMI Pre-compliance Test Software
(S1210 EMI Pre-compliance Software)

► Specifications

Specifications are valid under the following conditions: the instrument is within the calibration period, is stored for at least two hours at 0°C to 50°C temperature, and is warmed up for 40 minutes. Unless otherwise noted, the specifications in this manual include the measurement uncertainty.

Typical (typ.): characteristic performance, which 80 percent of the measurement results will meet at room temperature (approximately 25°C). This data is not warranted and does not include the measurement uncertainty.

Nominal (nom.): the expected mean or average performance or a designed attribute (such as the 50 Ω connector). This data is not warranted and is measured at room temperature (approximately 25°C).

Measured (meas.): an attribute measured during the design phase which can be compared to the expected performance, such as the amplitude drift variation with time. This data is not warranted and is measured at room temperature (approximately 25°C).

NOTE: All charts in this manual are the measurement results of multiple instruments at room temperature unless otherwise noted.

Frequency

Frequency		
	DSA705	DSA710
Frequency range	100 kHz to 500 MHz	100 kHz to 1 GHz
Frequency resolution	1 Hz	

Internal Reference Frequency		
	DSA705	DSA710
Reference frequency	10 MHz	
Accuracy	±[(time since last calibration × aging rate) + temperature stability + calibration accuracy]	
Initial calibration accuracy	<1 ppm	
Temperature stability	0°C to 50°C , reference to 25°C	
	<2 ppm	
Aging rate	<2 ppm/year	

Frequency Readout Accuracy	
Marker resolution	span/ (number of sweep points - 1)
Marker uncertainty	±(frequency indication × reference frequency accuracy + 1% × span + 10% × resolution bandwidth + marker resolution)

Frequency Counter	
Resolution	1 Hz, 10 Hz, 100 Hz, 1 kHz, 10 kHz, 100 kHz
Uncertainty	±(frequency indication × reference frequency accuracy + counter resolution)

Frequency Span	
Range	0 Hz, 100 Hz to maximum frequency of instrument
Uncertainty	±span/ (number of sweep points - 1)

SSB Phase Noise		
	DSA705	DSA710
	20°C to 30°C , $f_c = 500$ MHz	20°C to 30°C , $f_c = 1$ GHz
Carrier offset	10 kHz	<-80 dBc/Hz
	100 kHz	<-100 dBc/Hz (typ.)

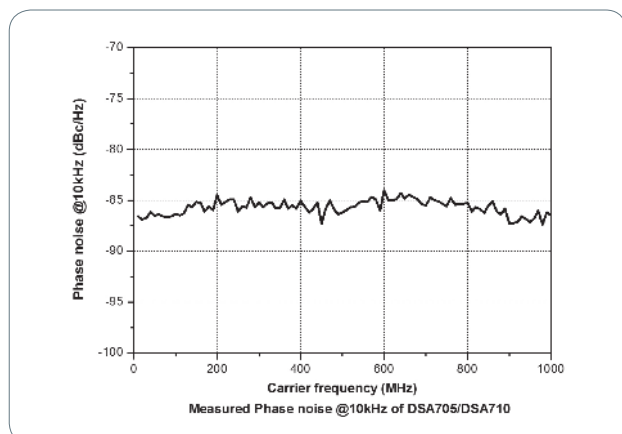

Residual FM		
	20°C to 30°C , RBW = VBW = 1 kHz	
	DSA705	DSA710
Residual FM		
	<50 Hz (nom.)	
Bandwidths		
	Set "Auto SWT" to "Accy"	
	DSA705	DSA710
Resolution bandwidth (-3 dB)		
	100 Hz to 1 MHz, in 1-3-10 sequence	
RBW uncertainty		
	<5% (nom.)	
Resolution filter shape factor (60 dB : 3 dB)		
	<5 (nom.)	
Video bandwidth (-3 dB)		
	1 Hz to 3 MHz, in 1-3-10 sequence	
Resolution bandwidth (-6 dB) (EMI-DSA800 option)		
	200 Hz, 9 kHz, 120 kHz	

Amplitude

Measurement Range		
Range	$f_c \geq 10$ MHz	
	DANL to +20 dBm	
Maximum Input Level		
DC voltage	50 V	
CW RF power	attenuation = 30 dB	
	+20 dBm (100 mW)	
Max. damage level ^[1]	+30 dBm (1 W)	

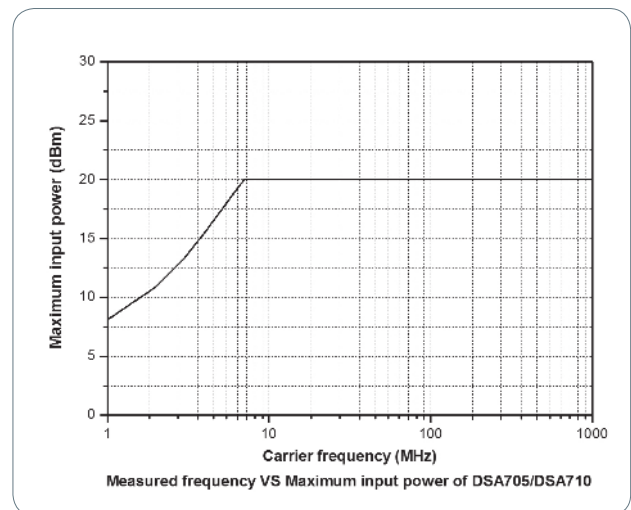
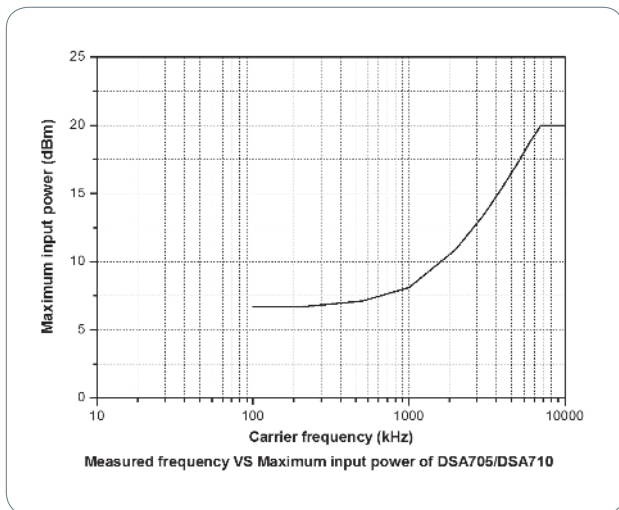

Displayed Average Noise Level (DANL)			
		DSA705	DSA710
Frequency		attenuation = 0 dB, RBW = VBW = 100 Hz, sample detector, trace average ≥ 50 , 20°C to 30°C , input impedance = 50 Ω	
PA off	100 kHz to 1 MHz	<-90 dBm, <-110 dBm (typ.)	<-90 dBm, <-110 dBm (typ.)
	1 MHz to 500 MHz	<-100 dBm, <-110 dBm (typ.)	<-100 dBm, <-110 dBm (typ.)
	500 MHz to 1 GHz		
PA on	100 kHz to 1 MHz	<-110 dBm, <-130 dBm (typ.)	<-110 dBm, <-130 dBm (typ.)
	1 MHz to 500 MHz	<-120 dBm, <-130 dBm (typ.)	<-120 dBm, <-130 dBm (typ.)
	500 MHz to 1 GHz		<-120 dBm, <-130 dBm (typ.)

NOTE: [1] When $f_c \geq 10$ MHz, input level > +25 dBm and PA is Off, the protection switch will be on.

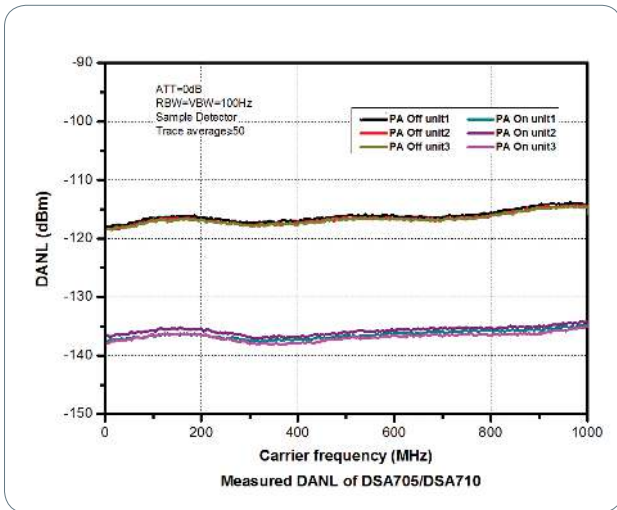

Level Display	
Logarithmic level axis	1 dB to 200 dB
Linear level axis	0 to reference level
Number of display points	601
Number of traces	3 + math trace
Trace detectors	normal, positive-peak, negative-peak, sample, RMS, voltage average quasi-peak (with EMI-DSA800 option)
Trace functions	clear write, max hold, min hold, average, view, blank
Units of level axis	dBm, dBmV, dBμV, nV, μV, mV, V, nW, μW, mW, W

Frequency Response		
	DSA705	DSA710
Frequency response	$f_c \geq 100$ kHz, attenuation = 10 dB, relative to 50 MHz, 20°C to 30°C	
PA off	100 kHz to 500 MHz	<0.7 dB
	500 MHz to 1 GHz	<0.7 dB
	$f_c \geq 1$ MHz, attenuation = 10 dB, relative to 50 MHz, 20°C to 30°C	
PA on	100 kHz to 500 MHz	<1.0 dB
	500 MHz to 1 GHz	<1.0 dB

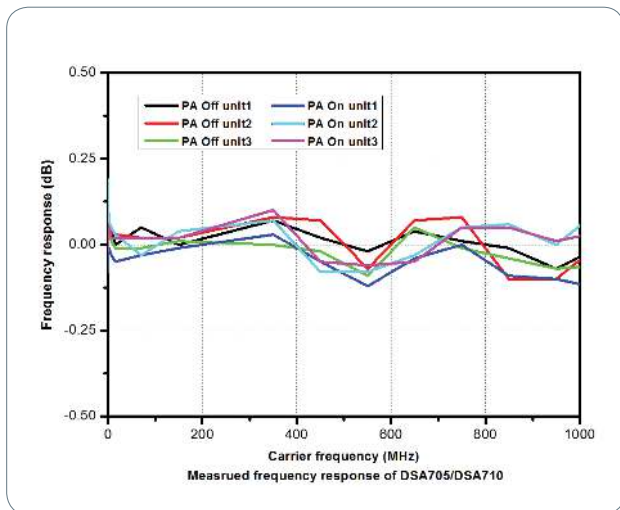

Input Attenuation Switching Uncertainty		
	DSA705	DSA710
Setting range	0 dB to 30 dB, in 1 dB step	
Switching uncertainty	$f_c = 50$ MHz, relative to 10 dB, 20°C to 30°C	
	<0.5 dB	

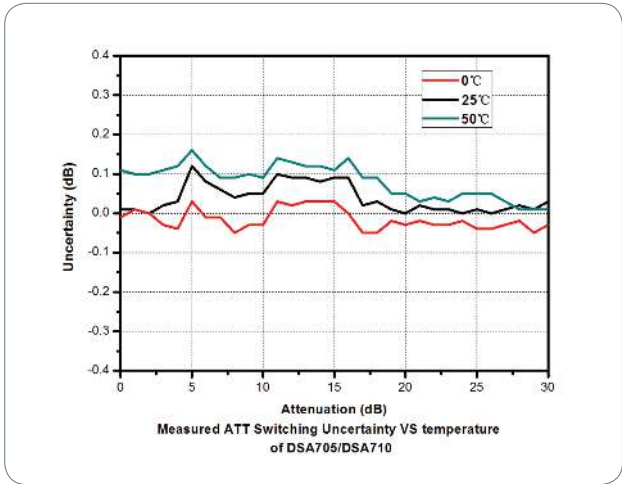

Absolute Amplitude Uncertainty

	DSA705	DSA710
Uncertainty	$f_c = 50 \text{ MHz}$, peak detector, preamplifier off, attenuation = 10 dB, input signal level = -10dBm, 20°C to 30°C <0.4 dB	

RBW Switching Uncertainty

Uncertainty	relative to 1 kHz RBW <0.1 dB
-------------	----------------------------------

Reference Level

Range	-100 dBm to +20 dBm, in 1 dB step	
Resolution	log scale	0.01 dB
	linear scale	4 digits

Preamplifier

		DSA705 (standard)	DSA710 (standard)
Gain	100 kHz to 500 MHz	20 dB (nom.)	20 dB (nom.)
	500 MHz to 1 GHz		

Level Measurement Uncertainty

	DSA705	DSA710
Level measurement uncertainty	95% confidence level, S/N > 20 dB, RBW = VBW = 1 kHz, preamplifier off, attenuation = 10 dB, -50 dBm < input level \leq 0 dBm, $f_c > 10 \text{ MHz}$, 20°C to 30°C <1.5 dB (nom.)	

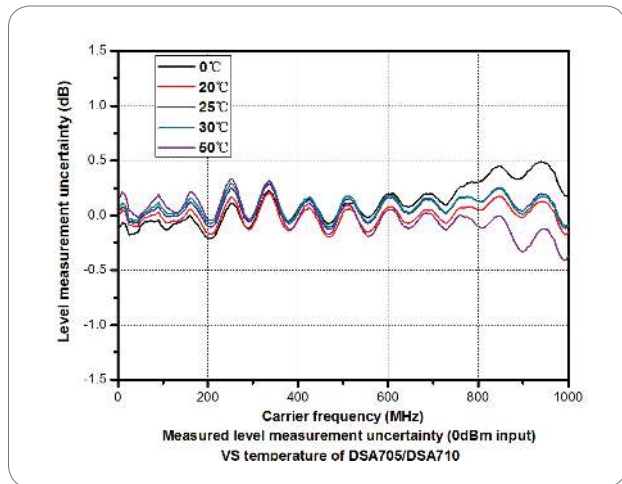

RF Input VSWR			
		DSA705	DSA710
		attenuation ≥ 10 dB	
VSWR	300 kHz to 500 MHz	<1.5 (nom.)	
	500 MHz to 1 GHz		

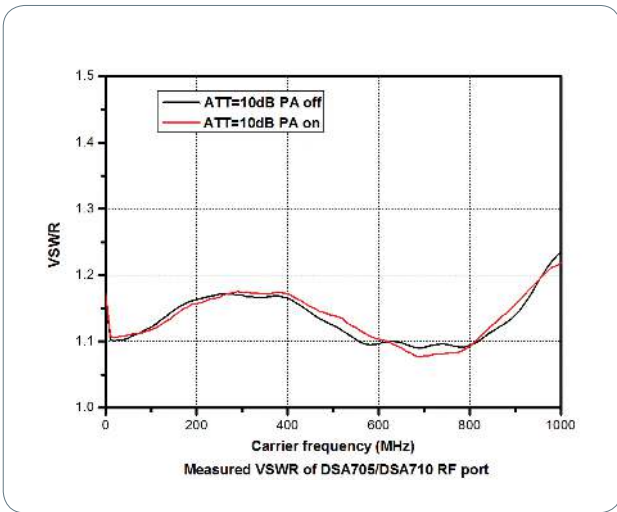

Distortion

Second Harmonic Intercept			
		DSA705	DSA710
Second harmonic intercept (SHI)		$f_c \geq 50$ MHz, input signal level = -20 dBm, attenuation = 10 dB	
		+40 dBm	
Third-order Intercept			
		DSA705	DSA710
Third-order intercept (TOI)		$f_c \geq 50$ MHz, two -20 dBm tones at input mixer spaced by 200 kHz, attenuation = 10 dB	
		+10 dBm	
1dB Gain Compression			
1dB compression of input mixer (P1dB)		$f_c \geq 50$ MHz, attenuation = 0 dB	
		>0 dBm	

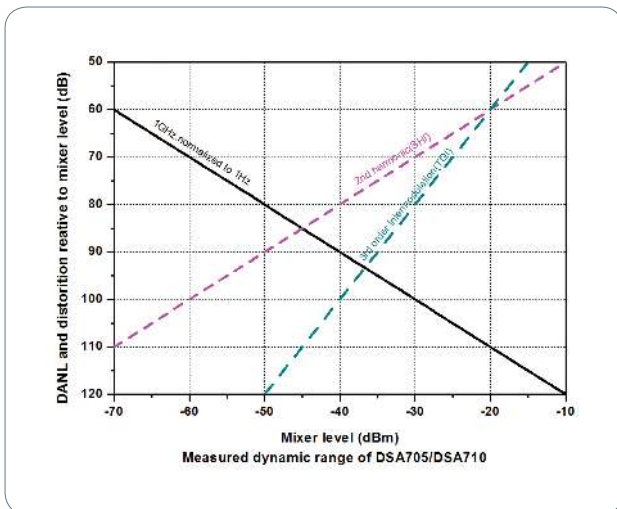

Spurious Response		
Spurious response, inherent	DSA705	DSA710
	input terminated 50 Ω , attenuation = 0 dB, 20°C to 30°C	
Intermediate frequency	<-88dBm (typ.)	
System related sidebands	<-60 dBc	
	referenced to local oscillators, referenced to A/D conversion, referenced to subharmonic of first LO, referenced to harmonic of first LO	
Input related spurious	referenced to local oscillators, referenced to A/D conversion, referenced to subharmonic of first LO, referenced to harmonic of first LO	
	<-60 dBc	
Input related spurious	mixer level = -30 dBm	
	<-60 dBc	

Sweep

Sweep			
Sweep time	span \geq 100 Hz	DSA705	DSA710
	zero span	10 ms to 500 s	10 ms to 1000 s
Sweep time uncertainty	span \geq 100 Hz	20 μ s to 500 s	20 μ s to 1000 s
	zero span (sweep time setting value > 1 ms)	5% (nom.)	5% (nom.)
Sweep mode	continuous, single		

Trigger

Trigger	
Trigger source	free run, video, external
External trigger level	5 V TTL level

SSC-DSA (Option)

Signal Seamless Capture (SSC)	
Measurement bandwidth	1.5 MHz

Input /Output

Front Panel Connectors		
RF input	impedance	50 Ω (nom.)
	connector	N female

Internal/ External Reference		
Internal reference	frequency	10 MHz
	output level	+3 dBm to +10 dBm, +8 dBm (typ.)
	impedance	50 Ω (nom.)
	connector	BNC female
External reference	frequency	10 MHz \pm 5 ppm
	input level	0 dBm to +10 dBm
	impedance	50 Ω (nom.)
	connector	BNC female

External Trigger Input		
External trigger input	impedance	1 k Ω (nom.)
	connector	BNC female

Communication Interface		
USB host	connector	A plug
	protocol	version2.0
USB device	connector	B plug
	protocol	version2.0
LAN	LXI core 2011 device	10/100Base, RJ-45
IEC/IEEE (GPIB) bus (USB-GPIB option)		IEEE488.2

General Specifications

Display		
Type	TFT LCD	
Resolution	800 x 480 pixels	
Size	8 inch	
Colors	64k	
Printer Supported		
Protocol	PictBridge	
Mass Memory		
Mass memory	flash disk (internal), USB storage device (not supplied)	
Power Supply		
Input voltage range, AC	100 V to 240 V (nom.)	
AC supply frequency	45 Hz to 440 Hz	
Power consumption	35 W (typ.), max. 50 W with all options	
Environmental		
Temperature	operating temperature range	0°C to 50°C
	storage temperature range	-20°C to 70°C
Humidity	0°C to 30°C	≤ 95% rel. humidity
	30°C to 40°C	≤ 75% rel. humidity
Altitude	operating height	up to 3,000m
Electromagnetic Compatibility and Safety		
EMC	in line with EMC instruction (2014/30/EU), in line with or exceed IEC61326-1: 2013/EN61326-1: 2013 Group 1 Class A standard CISPR 11/EN 55011	
	IEC 61000-4-2:2008/EN 61000-4-2	±4.0 kV (contact discharge), ±8.0 kV (air discharge)
	IEC 61000-4-3:2002/EN 61000-4-3	3 V/m (80 MHz to 1 GHz); 3 V/m (1.4 GHz to 2 GHz); 1 V/m (2.0 GHz to 2.7 GHz)
	IEC 61000-4-4:2004/EN 61000-4-4	1 kV power lines
	IEC 61000-4-5:2001/EN 61000-4-5	0.5 kV (phase to neutral); 1 kV (phase to PE); 1 kV (neutral to PE)
	IEC 61000-4-6:2003/EN 61000-4-6	3 V, 0.15-80MHz
	IEC 61000-4-11: 2004/EN 61000-4-11	voltage dip: 0% UT during half cycle; 0% UT during 1 cycle; 70% UT during 25 cycles short interruption: 0% UT during 250 cycles
Electrical safety	IEC 61010-1:2010 (Third Edition)/EN 61010-1:2010, UL 61010-1:2012 R4.16 and CAN/CSA-C22.2 NO. 61010-1-12+ G11+ G12	
Dimensions		
(W x H x D)	361.6 mm × 178.8 mm × 128 mm (14.2 in × 7.0 in × 5.0 in)	
Weight		
Standard	DSA705	DSA710
	4.25 kg (9.4 lb)	
Calibration Interval		
Recommended calibration interval	18 months	

Ordering Information

	Description	Order Number
Model	spectrum analyzer, 100 kHz to 500 MHz (with preamplifier)	DSA705
	spectrum analyzer, 100 kHz to 1 GHz (with preamplifier)	DSA710
Standard accessories	quick guide (hard copy)	-
	power cable	-
Options	EMI filter & quasi-peak detector	EMI-DSA800
	advanced measurement kit	AMK-DSA800
	DSA PC software	Ultra Spectrum
	signal seamless capture	SSC-DSA
Optional accessories	include: N-SMA cable, BNC-BNC cable, N-BNC adaptor, N-SMA adaptor, 75 Ω to 50 Ω adaptor, 900 MHz/1.8 GHz antenna (2pcs), 2.4 GHz antenna (2pcs)	DSA Utility Kit
	include: N(F)-N(F) adaptor (1pcs), N(M)-N(M) adaptor (1pcs), N(M)-SMA(F) adaptor (2pcs), N(M)-BNC(F) adaptor (2pcs), SMA(F)-SMA(F) adaptor (1pcs), SMA(M)-SMA(M) adaptor (1pcs), BNC T type adaptor (1pcs), 50 Ω SMA load (1pcs), 50 Ω BNC impedance adaptor (1pcs)	RF Adaptor Kit
	include: 50 Ω to 75 Ω adaptor (2pcs)	RF CATV Kit
	include: 6dB attenuator (1pcs), 10dB attenuator (2pcs)	RF Attenuator Kit
	30dB high power attenuator, max. power 100W	ATT03301H
	N(M)-N(M) RF cable	CB-NM-NM-75-L-12G
	N(M)-SMA(M) RF cable	CB-NM-SMAM-75-L-12G
	RF demo kit (transmitter)	TX1000
	RF demo kit (receiver)	RX1000
	near field probe	NFP-3
	EMI pre-compliance test software	S1210 EMI Pre-compliance Software
	rack mount kit	RM-DSA800
	soft carrying bag	BAG-G1
	USB cable	CB-USBA-USBB-FF-150
USB to GPIB interface converter for instrument	USB-GPIB	

RIGOL

HEADQUARTER

RIGOL TECHNOLOGIES, INC.
No.156,Cai He Village,
Sha He Town,
Chang Ping District, Beijing,
102206 P.R.China
Tel:+86-10-80706688
Fax:+86-10-80720067
Electronic Measurement
Instrument service and support
email:EMD_support@rigol.com

EUROPE

RIGOL TECHNOLOGIES EU GmbH
Lindbergh str. 4
82178 Puchheim
Germany
Tel: 0049- 89/89418950
Email: info-europe@rigol.com

NORTH AMERICA

RIGOL TECHNOLOGIES, USA INC.
8140 SW Nimbus Ave.
Beaverton, OR 97008
Tel: 877-4-**RIGOL**-1
Email: info@rigol.com

JAPAN

RIGOL TECHNOLOGIES JAPAN, LLC
MJ BLDG.3F,1-7-4 MINATO,CHUOU-
KU,TOKYO,JAPAN 〒104-0043
Tel: 03-6262-8932
Fax: 03-6262-8933
Email: info-japan@rigol.com

RIGOL® is the registered trademark of **RIGOL** Technologies, Inc. Product information in this document subject to update without notice. For the latest information about **RIGOL**'s products, applications and services, please contact local **RIGOL** office or access **RIGOL** official website: www.rigol.com