

Application

- ❖ Low-loss Saw Duplexer for mobile telephone LTE and WCDMA Band3 systems.
- ❖ Low insertion attenuation and low passband ripple.
- ❖ Usable passband 75 MHz
- ❖ High isolation between Tx and Rx.

Electrical Specifications

Parameters			Specification	Unit	
Tx to ANT	Center Frequency		1747.500	MHz	
	Insertion Loss, typ/max		1710 ~ 1785 MHz	2.3 / 2.6	dB
			1712.5 ~ 1782.5 MHz	2.2 / 2.4	dB
	Amplitude Ripple Any 5MHz, typ/max		1710 ~ 1785 MHz	0.6 / 1.0	dB
	VSWR, typ/max	ANT	1710 ~ 1785 MHz	1.6 / 2.0	-
		Rx	1710 ~ 1785 MHz	1.6 / 2.0	-
	Input Power (+50°C, 5000h, CW)		1710 ~ 1785 MHz	30	dBm
	Attenuation, min/typ		10 ~ 960 MHz	30 / 38	dB
			1164 ~ 1189 MHz	28 / 37	dB
			1559 ~ 1606 MHz	28 / 33	dB
			1606 ~ 1680 MHz	15 / 30	dB
			1805 ~ 1880 MHz	42 / 46	dB
			1920 ~ 1980 MHz	30 / 42	dB
			2110 ~ 2170 MHz	27 / 30	dB
2400 ~ 2500 MHz			28 / 31	dB	
2620 ~ 2690 MHz			27 / 30	dB	
3420 ~ 3570 MHz			25 / 29	dB	
4900 ~ 5850 MHz	8 / 28	dB			
ANT to Rx	Center Frequency		1842.500	dB	
	Insertion Loss, typ/max		1805 ~ 1880 MHz	2.7 / 3.4	dB
			1807.5 ~ 1877.5 MHz	2.3 / 3.0	dB
	Pass Band Ripple Any 5MHz, typ/max		1805 ~ 1880 MHz	0.5 / 1.0	dB
	VSWR, typ/max	ANT	1805 ~ 1880 MHz	1.7 / 2.0	-
		Rx	1805 ~ 1880 MHz	1.6 / 2.0	-
	Attenuation, min/typ		10 ~ 1710 MHz	40 / 43	dB
			718 ~ 748 MHz	40 / 54	dB
			814 ~ 849 MHz	40 / 52	dB
			832 ~ 862 MHz	40 / 51	dB
880 ~ 915 MHz			40 / 50	dB	
1447 ~ 1463 MHz			40 / 43	dB	
1710 ~ 1785 MHz			42 / 50	dB	
1920 ~ 2400 MHz			38 / 41	dB	
2400 ~ 2500 MHz	40 / 46	dB			

		2500 ~ 2570 MHz	40 / 48	dB
		2570 ~ 3760 MHz	35 / 50	dB
		4900 ~ 5950 MHz	30 / 48	dB
Tx to Rx	Isolation, min/typ	1710 ~ 1785 MHz	50 / 53	dB
		1805 ~ 1880 MHz	53 / 53	dB
DC Voltage			5	V
ESD Voltage ESD (MM)			50	V
Sensitive Discharge Device ESD (HBM)			175	V
Operating Temperature Range			-30 ~ +85	°C
Storage Temperature Range			-40 ~ +85	°C
MSL			2	-

Dimension

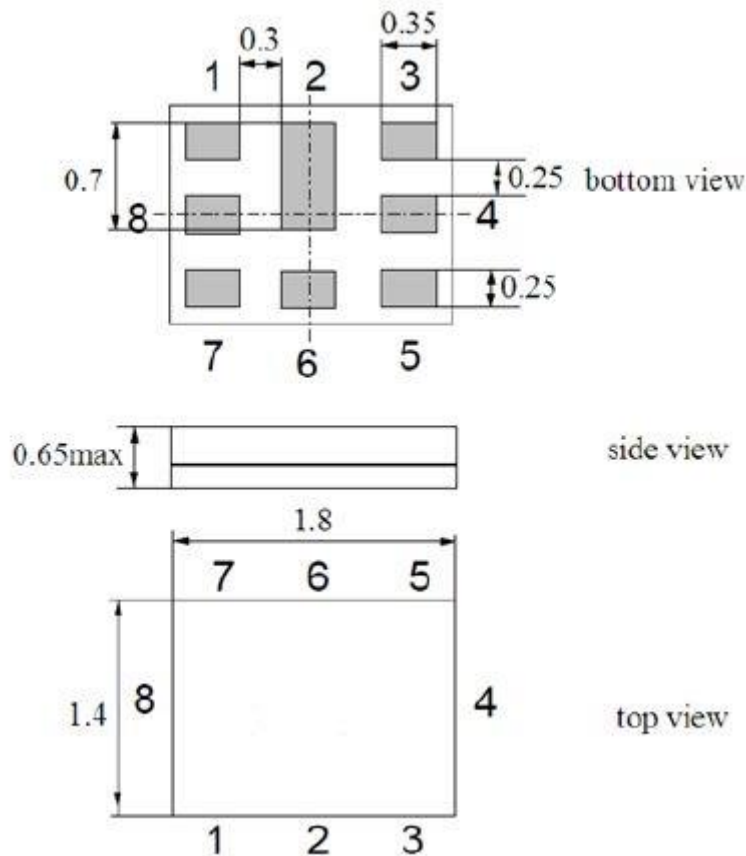

PIN	SYMBOL	FUNCTION
1	Rx	Rx Output
2,4,5,7,8	GND	Ground
3	Tx	Tx Input
6	ANT	Antenna

Unit: mm

Test Circuit

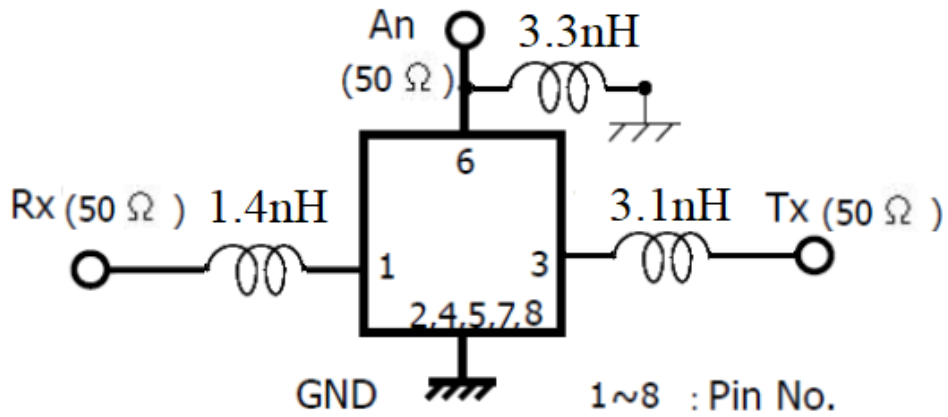

Frequency Characteristics

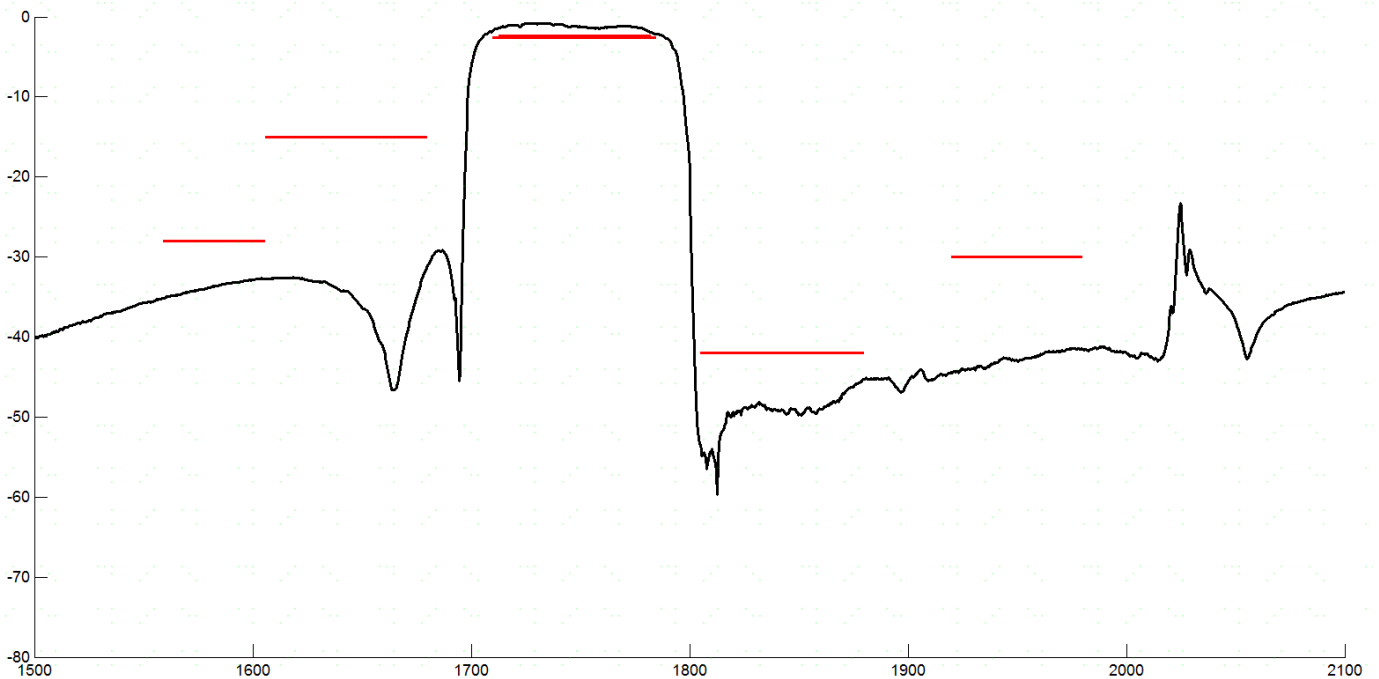

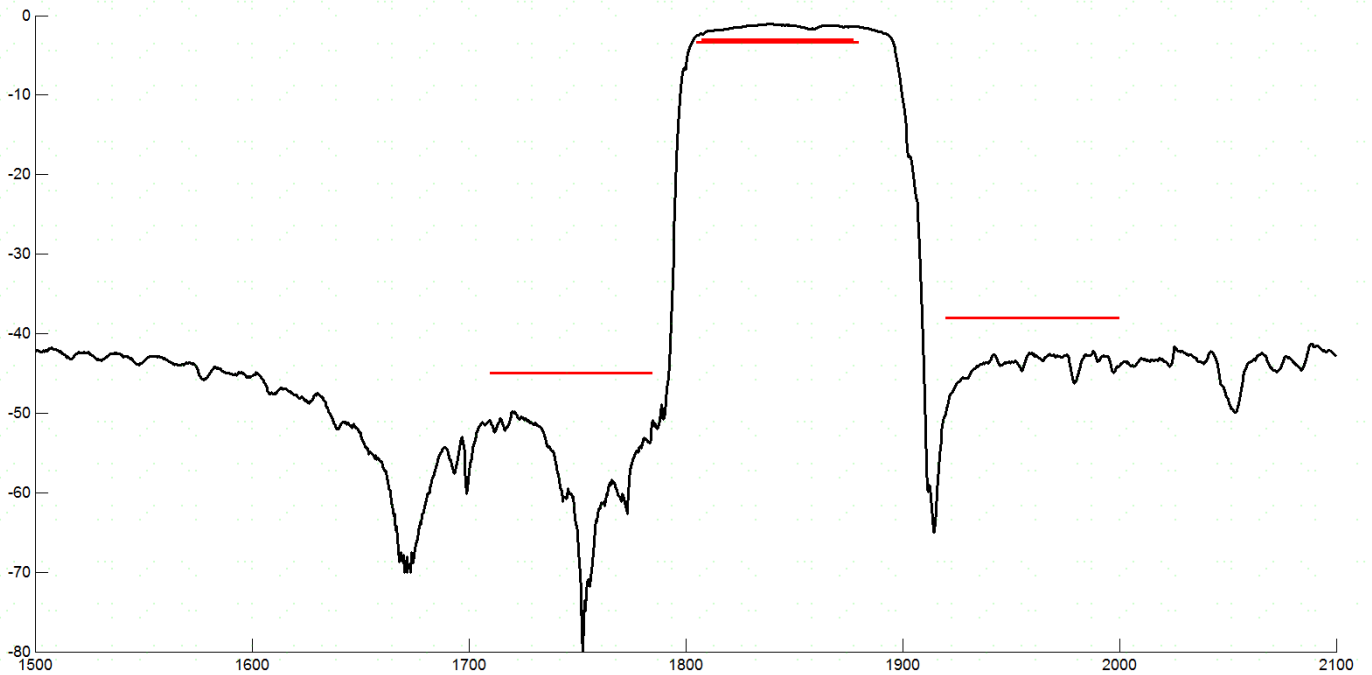
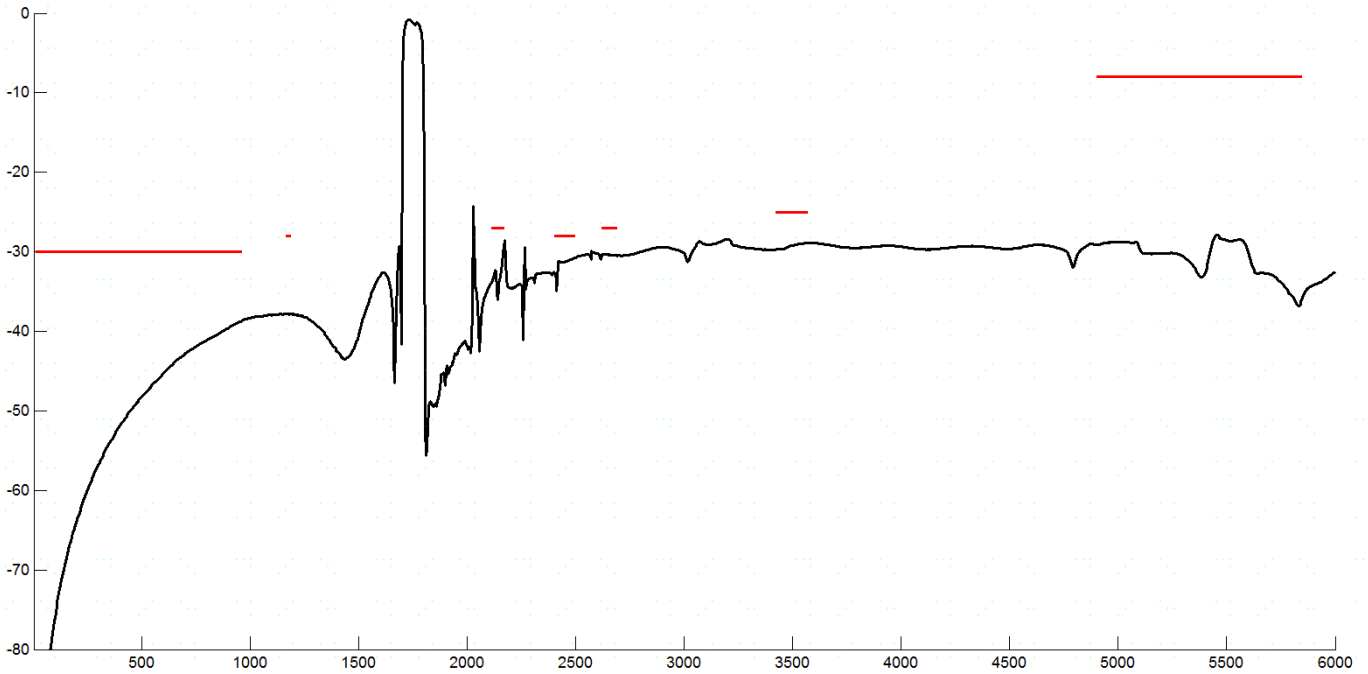

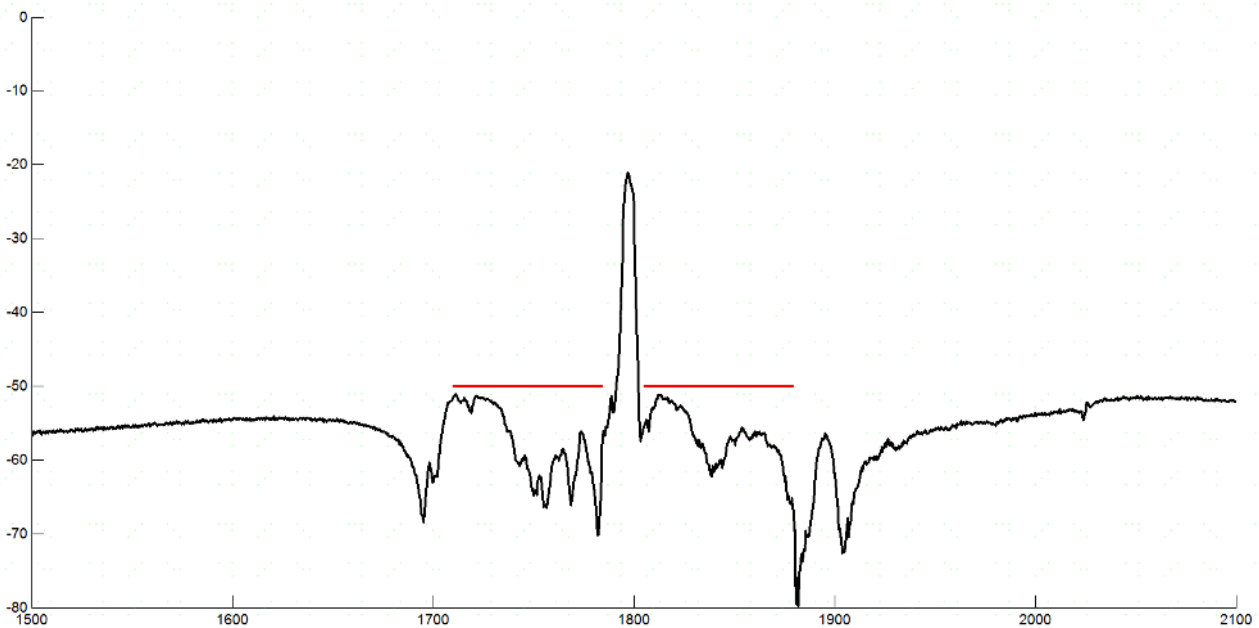
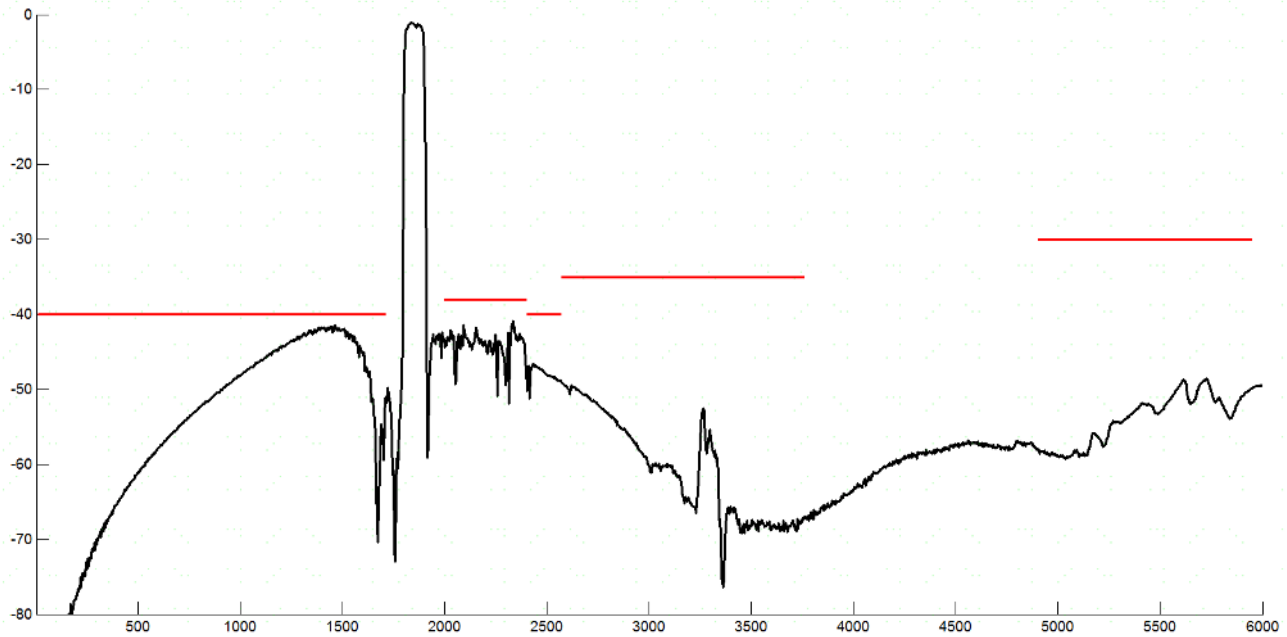

APPROVAL

DRAWN BY	AR, August 10, 2021
APPROVED BY	CP, August 10, 2021
REVISION	A, Initial Release



Raltron Electronics / RAMI Technology USA, LLC, including its affiliates, employees, agents and other persons acting on its behalf (collectively Raltron/RAMI Tech), disclaim any and all liability for any errors or inaccuracies contained in this data sheet. While Raltron/RAMI Tech has made every reasonable effort to ensure the accuracy of all product information, specifications and data contained herein, Raltron/RAMI Tech does not guarantee that the information is accurate, reliable or current. The product information is provided only for reference purposes only and is subject to change, correction or revision, at any time without notice. Raltron/RAMI Tech does not assume any liability arising out of an application or use of any product described herein and disclaims any warranties expressed or implied. The user of products in such applications shall assume all risks of such use and will agree to hold Raltron/RAMI Tech, harmless against all damages.

Copyright © 2016, Raltron Electronics / RAMI Technology USA, LLC. All rights reserved. No part of this document may be reproduced in any form without the prior written permission of Raltron Electronics / RAMI Technology USA, LLC.