

# Analog Devices Welcomes Hittite Microwave Corporation

NO CONTENT ON THE ATTACHED DOCUMENT HAS CHANGED

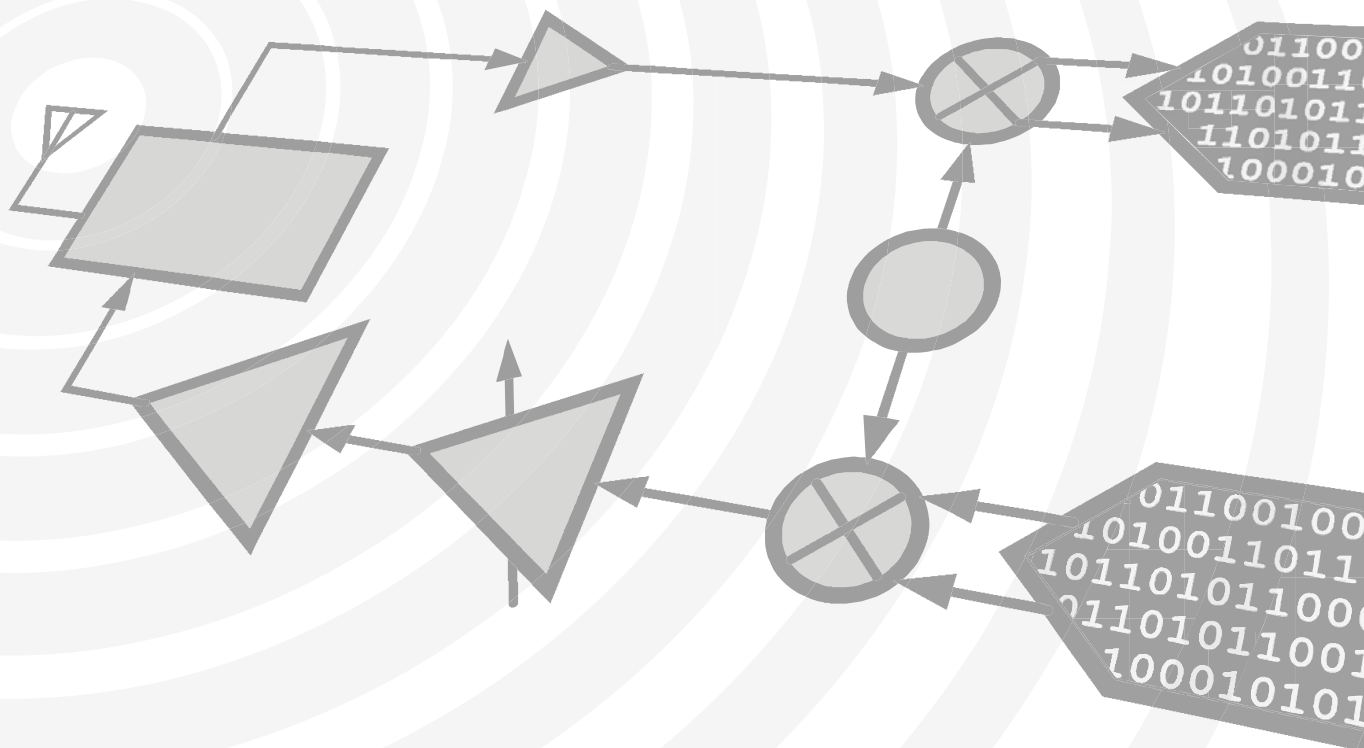

**THIS PAGE INTENTIONALLY LEFT BLANK**



## 0.5 dB LSB GaAs MMIC 6-BIT DIGITAL VARIABLE GAIN AMPLIFIER, 70 MHz - 4 GHz

### Typical Applications

The HMC742LP5E is ideal for:

- Cellular/3G Infrastructure
- WiBro / WiMAX / 4G
- Microwave Radio & VSAT
- Test Equipment and Sensors
- IF & RF Applications

### Features

- 19.5 to 12 dB Gain Control in 0.5 dB Steps
- Power-up State Selection
- High Output IP3: +39 dBm
- TTL/CMOS Compatible
- Serial, Parallel, or latched Parallel Control
- ±0.25 dB Typical Gain Step Error
- Single +5V Supply
- 32 Lead 5x5mm SMT Package: 25mm<sup>2</sup>

### Functional Diagram

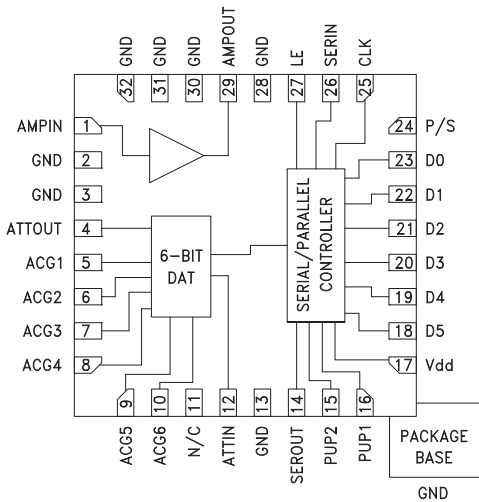

### General Description

The HMC742LP5E is a digitally controlled variable gain amplifier which operates from 70 MHz to 4 GHz, and can be programmed to provide from -19.5 dB attenuation, to 12 dB of gain, in 0.5 dB steps. The HMC742LP5E delivers noise figure of 4 dB in its maximum gain state, with output IP3 of up to +39 dBm in any state. The dual mode gain control interface accepts either a three-wire serial input or a 6 bit parallel word. The HMC742LP5E also features a user selectable power up state and a serial output for cascading other serially controlled Hittite components. The HMC742LP5E is housed in an RoHS compliant 5x5 mm QFN leadless package, and requires minimal external components.

### Electrical Specifications, $T_A = +25^\circ C$ , 50 Ohm System $V_{dd} = +5V$ , $V_s = +5V$

Parameter	Min.	Typ.	Max.	Min.	Typ.	Max.	Units
		70 - 1000			500 - 4000		
Gain (Maximum Gain State)		12			9		dB
Gain Control Range		31.5			31.5		dB
Input Return Loss		15			12		dB
Output Return Loss		14			10		dB
Gain Accuracy: (Referenced to Maximum Gain State) All Gain States	70 MHz - 350 MHz ± (0.3 + 5% of relative gain setting) Max			± (0.3 + 4% of relative gain setting) Max			dB
	350 MHz - 1000 MHz ± (0.3 + 6% of relative gain setting) Max						
Output Power for 1 dB Compression		21.5			22		dBm
Output Third Order Intercept Point (Two-Tone Output Power= 12 dBm Each Tone)		40			39		dBm
Noise Figure (Max Gain State)		4			4.5		dB
Switching Characteristics tRISE, tFall (10 / 90% RF)		70			70		ns
tON, tOFF (Latch Enable to 10 / 90% RF)		170			170		ns
Supply Current (Amplifier)	130	150	190	130	150	190	mA
Supply Current (Controller) Idd	1.0	2.0	3.0	1.0	2.0	3.0	mA

For price, delivery and to place orders: Hittite Microwave Corporation, 20 Alpha Road, Chelmsford, MA 01824

Phone: 978-250-3343 Fax: 978-250-3373 Order On-line at [www.hittite.com](http://www.hittite.com)

Application Support: Phone: 978-250-3343 or [apps@hittite.com](mailto:apps@hittite.com)

## 0.5 dB LSB GaAs MMIC 6-BIT DIGITAL VARIABLE GAIN AMPLIFIER, 70 MHz - 4 GHz

### 70 to 1000 MHz Tuning

**Maximum Gain vs. Temperature**

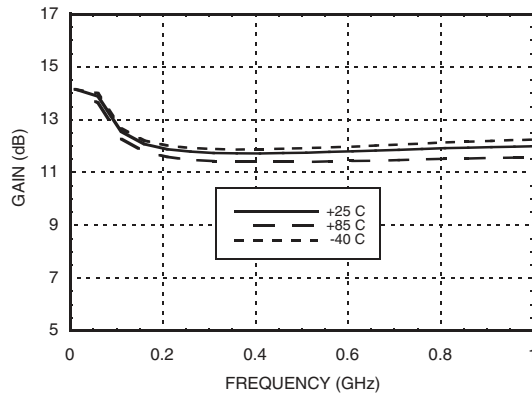

**Relative Gain Setting**

(Referenced to Maximum Gain State)

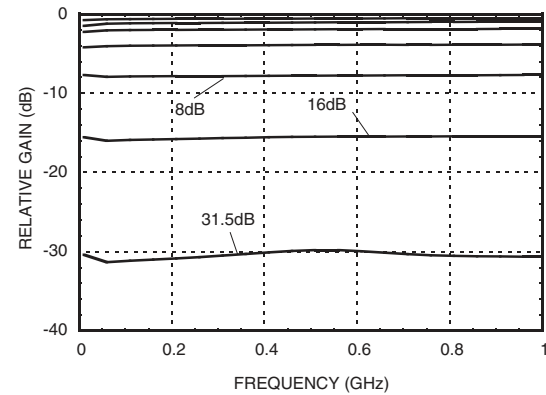

**Input Return Loss**

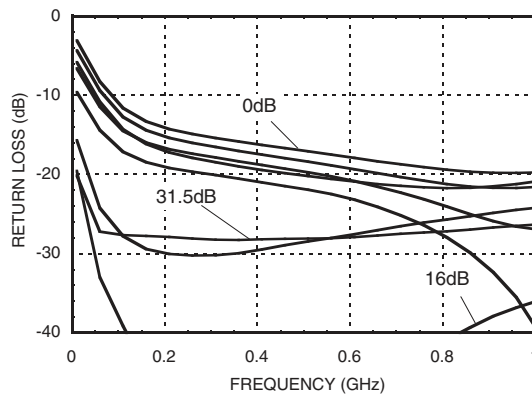

**Output Return Loss**

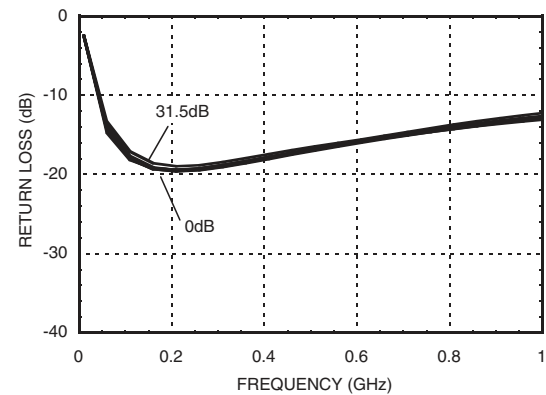

**Bit Error vs. Frequency**

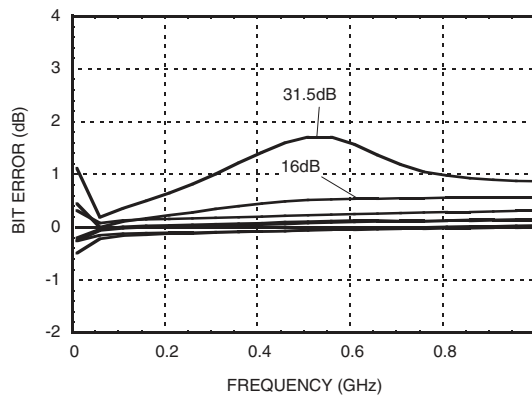

**Bit Error vs. Relative Gain**

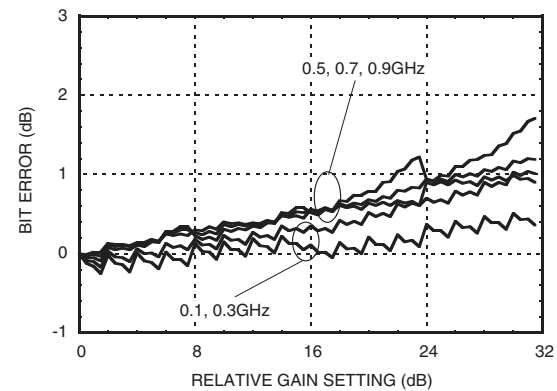



## 0.5 dB LSB GaAs MMIC 6-BIT DIGITAL VARIABLE GAIN AMPLIFIER, 70 MHz - 4 GHz

### 70 to 1000 MHz Tuning

**Relative Phase vs. Frequency**

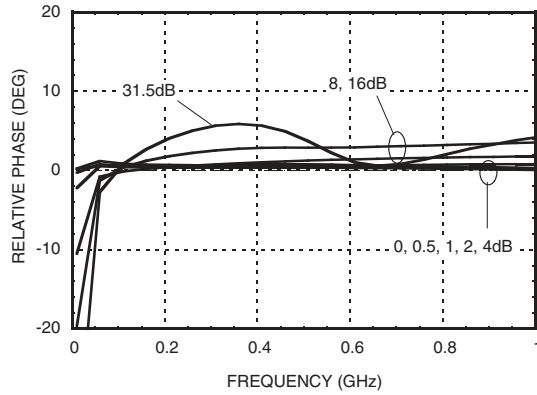

**Step Error vs. Frequency**

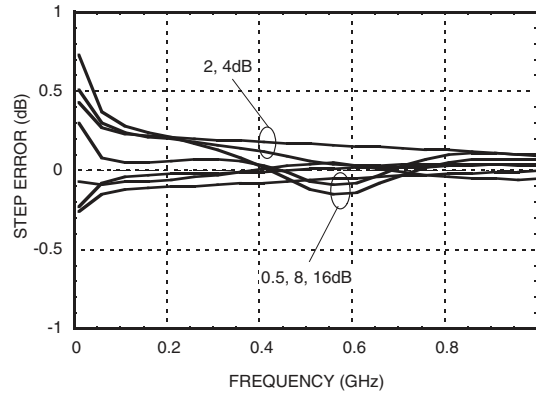

**Noise Figure vs. Temperature [1]**

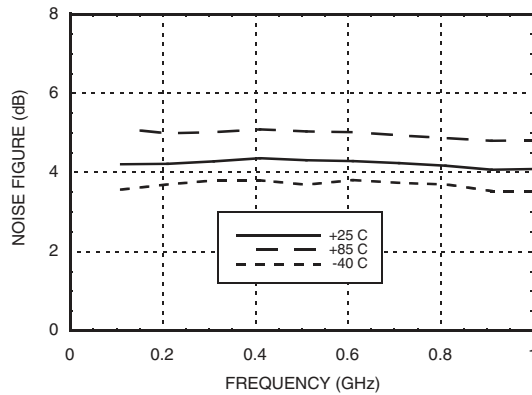

**Output P1dB vs. Temperature**

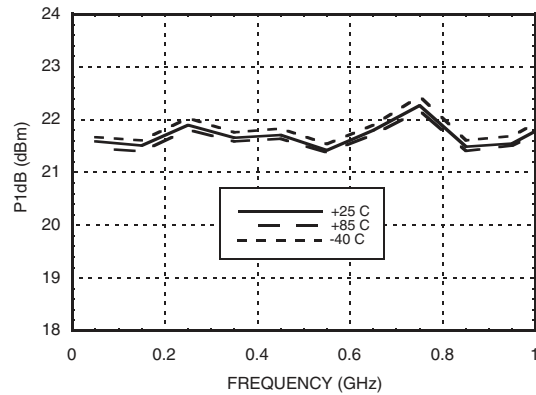

**Psat vs. Temperature**

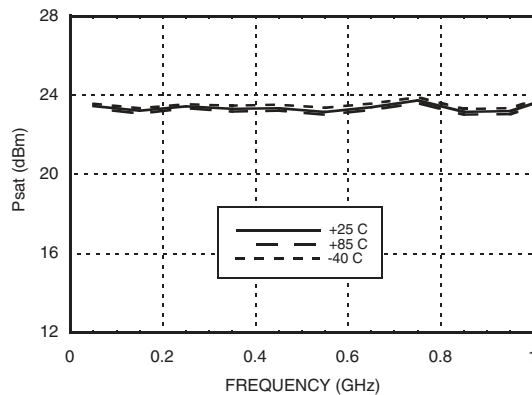

**Output IP3 vs. Temperature**

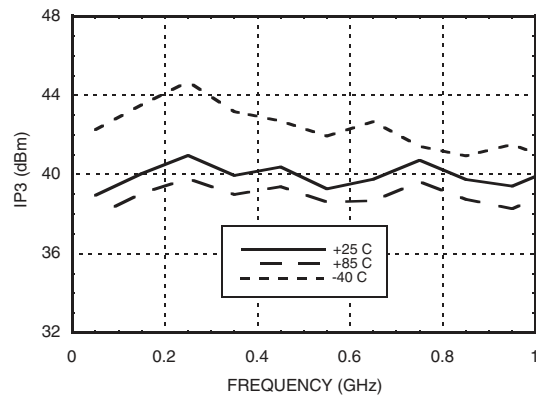

[1] Max Gain State

## 0.5 dB LSB GaAs MMIC 6-BIT DIGITAL VARIABLE GAIN AMPLIFIER, 70 MHz - 4 GHz

### 0.5 to 4.0 GHz Tuning

**Maximum Gain vs. Frequency**

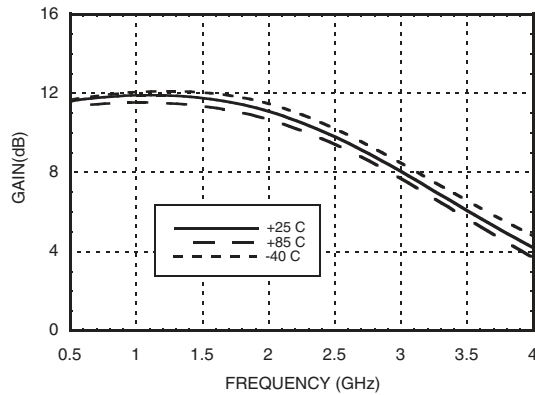

**Relative Gain Setting**

(Referenced to Maximum Gain State)

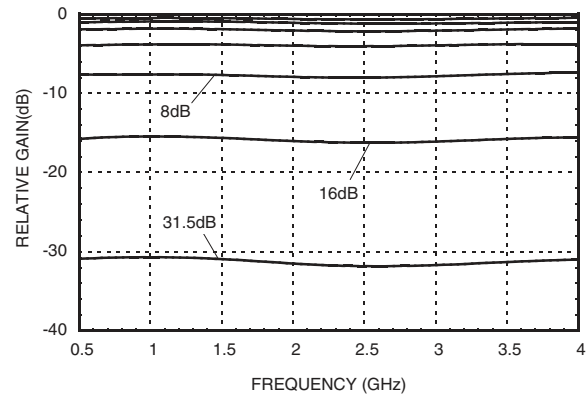

**Input Return Loss**

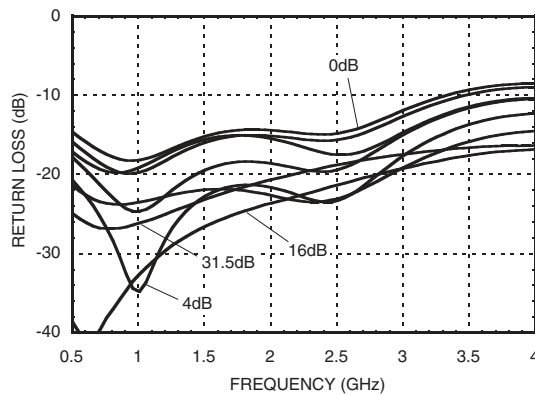

**Output Return Loss**

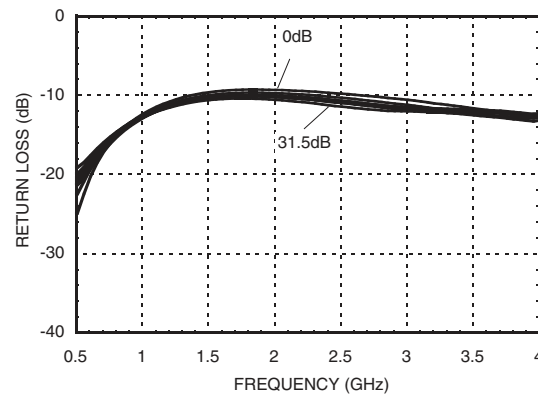

**Bit Error vs. Frequency**

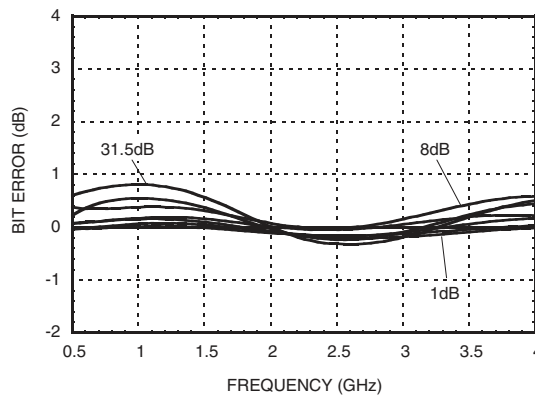

**Bit Error vs. Relative Gain**

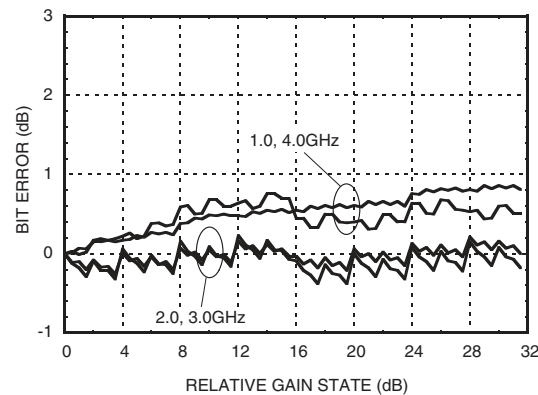



## 0.5 dB LSB GaAs MMIC 6-BIT DIGITAL VARIABLE GAIN AMPLIFIER, 70 MHz - 4 GHz

### 0.5 to 4.0 GHz Tuning

**Relative Phase vs. Frequency**

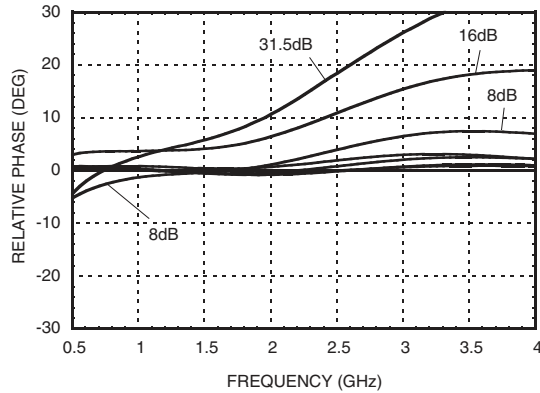

**Step Error vs. Frequency**

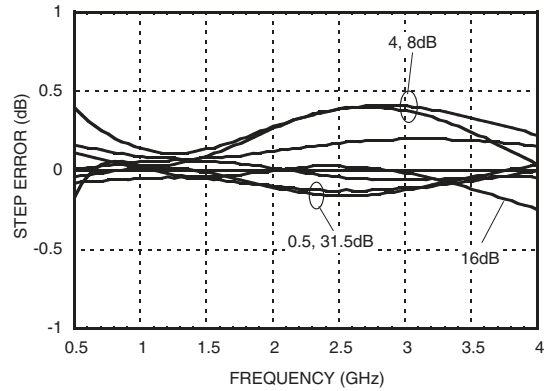

**Noise Figure vs. Frequency [1]**

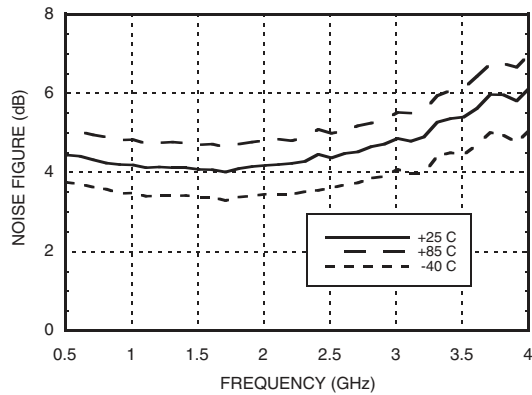

**Output P1dB vs. Temperature**

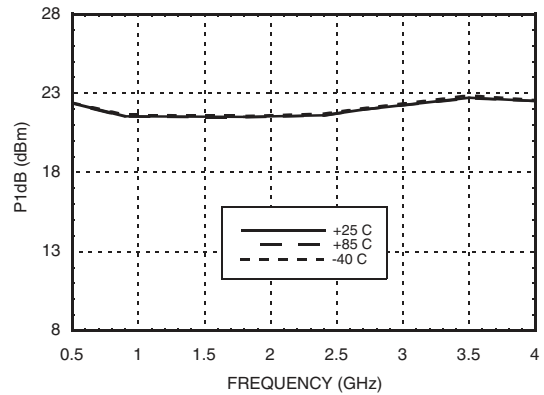

**Psat vs. Temperature**

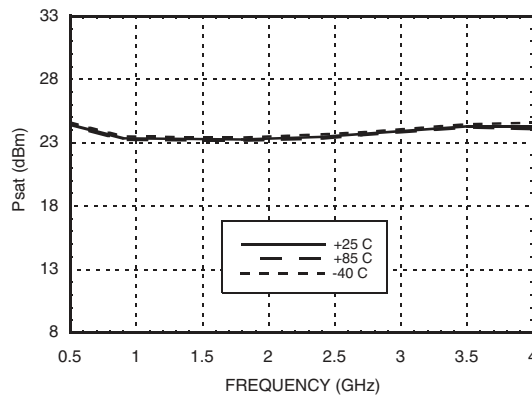

**Output IP3 vs. Temperature**

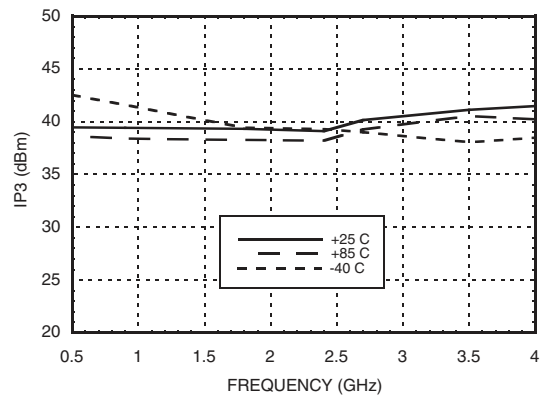

[1] Max Gain State

**0.5 dB LSB GaAs MMIC 6-BIT DIGITAL VARIABLE GAIN AMPLIFIER, 70 MHz - 4 GHz**
**Serial Control Interface**

The HMC742LP5E contains a 3-wire SPI compatible digital interface (SERIN, CLK, LE). The serial control interface is activated when P/S is kept high. The 6-bit serial word must be loaded MSB first. The positive-edge sensitive CLK and LE requires clean transitions. If mechanical switches are used, sufficient debouncing should be provided. When LE is high, 6-bit data in the serial input register is transferred to the attenuator. When LE is high CLK is masked to prevent data transition during output loading.

When P/S is low, 3-wire SPI interface inputs (SERIN, CLK, LE) are disabled and the input register is loaded with parallel digital inputs (D0-D5). When LE is high, 6-bit parallel data changes the state of the part per truth table.

For all modes of operations, the DVGA state will stay constant while LE is kept low.

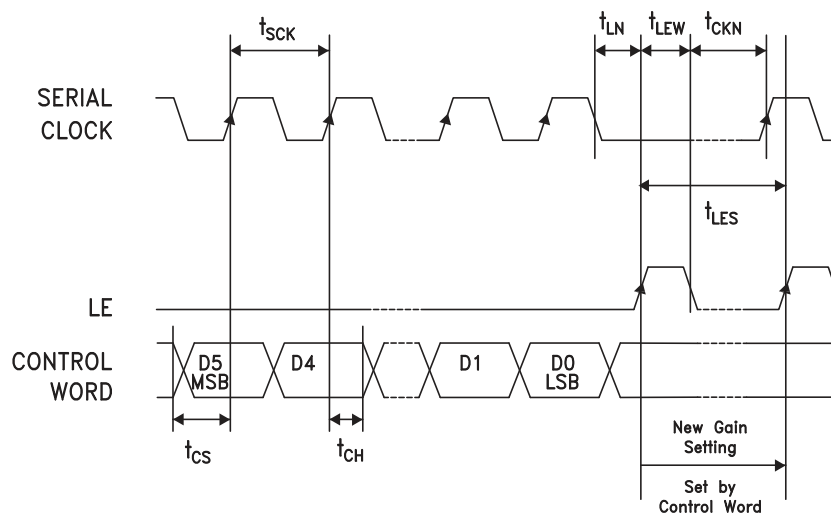

Parameter	Typ.
Min. serial period, $t_{SCK}$	100 ns
Control set-up time, $t_{CS}$	20 ns
Control hold-time, $t_{CH}$	20 ns
LE setup-time, $t_{LN}$	10 ns
Min. LE pulse width, $t_{LEW}$	10 ns
Min LE pulse spacing, $t_{LES}$	630 ns
Serial clock hold-time from LE, $t_{CKN}$	10 ns
Hold Time, $t_{PH}$	0 ns
Latch Enable Minimum Width, $t_{LEN}$	10 ns
Setup Time, $t_{PS}$	2 ns

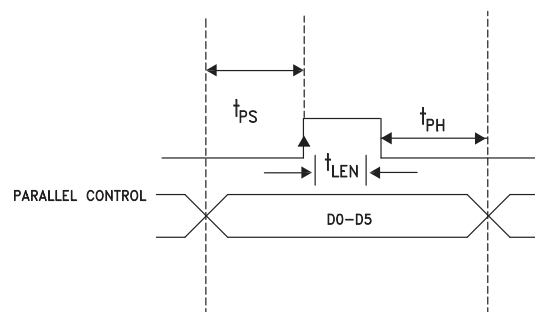
**Timing Diagram (Latched Parallel Mode)**

**Parallel Mode**
**(Direct Parallel Mode & Latched Parallel Mode)**

**Note:** The parallel mode is enabled when P/S is set to low.

**Direct Parallel Mode** - The attenuation state is changed by the control voltage inputs D0-D5 directly. The LE (Latch Enable) must be at a logic high at all times to control the attenuator in this manner.

**Latched Parallel Mode** - The attenuation state is selected using the control voltage inputs D0-D5 and set while the LE is in the Low state. The attenuator will not change state while LE is Low. Once all Control Voltage Inputs are at the desired states the LE is pulsed. See timing diagram above for reference.



**0.5 dB LSB GaAs MMIC 6-BIT DIGITAL  
VARIABLE GAIN AMPLIFIER, 70 MHz - 4 GHz**
**Power-Up States**

If LE is set to logic LOW at power-up, the logic state of PUP1 and PUP2 determines the power-up state of the part per PUP truth table. If the LE is set to logic HIGH at power-up, the logic state of D0-D5 determines the power-up state of the part per truth table. The DVGA latches in the desired power-up state approximately 200 ms after power-up.

**Power-On Sequence**

The ideal power-up sequence is: GND, Vdd, digital inputs, RF inputs. The relative order of the digital inputs are not important as long as they are powered after Vdd / GND

**Absolute Maximum Ratings**

RF Input Power at Max Gain [1]	17.5 dBm (T = +85 °C)
Digital Inputs (Reset, Shift Clock, Latch Enable & Serial Input)	-0.5 to Vdd +0.5V
Bias Voltage (Vdd)	5.6V
Collector Bias Voltage (Vcc)	5.5V
Channel Temperature	175 °C
Continuous P <sub>diss</sub> (T = 85 °C) (derate 13.3 mW/°C above 85 °C) [2]	1.2 W
Thermal Resistance [3]	75.6 °C/W
Storage Temperature	-65 to +150 °C
Operating Temperature	-40 to +85 °C

[1] The maximum RF input power increases by the same amount the gain is reduced. The maximum input power at any state is no more than 28 dBm.

[2] This value does not include the RF power dissipation in the attenuator. The loss in the attenuator depends on the state of the attenuator. The loss in the attenuator should be included to determine the total power dissipation in the part.

[3] This value does not include the RF power dissipation in the attenuator. The thermal resistance at different states of the attenuator can be determined based on note [2]

**Bias Voltage**

Vdd (V)	I <sub>dd</sub> (Typ.) (mA)
+5.0	2
Vs (V)	I <sub>s</sub> (mA)
+5.0	150

**PUP Truth Table**

LE	PUP1	PUP2	Gain Relative to Maximum Gain
0	0	0	-31.5
0	1	0	-24
0	0	1	-16
0	1	1	Insertion Loss
1	X	X	0 to -31.5 dB

Note: The logic state of D0 - D5 determines the power-up state per truth table shown below when LE is high at power-up.

**Truth Table**

Control Voltage Input						Gain Relative to Maximum Gain
D5	D4	D3	D2	D1	D0	
High	High	High	High	High	High	0 dB
High	High	High	High	High	Low	-0.5 dB
High	High	High	High	Low	High	-1 dB
High	High	High	Low	High	High	-2 dB
High	High	Low	High	High	High	-4 dB
High	Low	High	High	High	High	-8 dB
Low	High	High	High	High	High	-16 dB
Low	Low	Low	Low	Low	Low	-31.5 dB

Any combination of the above states will provide a reduction in gain approximately equal to the sum of the bits selected.

**Control Voltage Table**

State	Vdd = +3V	Vdd = +5V
Low	0 to 0.5V @ <1 μA	0 to 0.8V @ <1 μA
High	2 to 3V @ <1 μA	2 to 5V @ <1 μA



**ELECTROSTATIC SENSITIVE DEVICE  
OBSERVE HANDLING PRECAUTIONS**



## 0.5 dB LSB GaAs MMIC 6-BIT DIGITAL VARIABLE GAIN AMPLIFIER, 70 MHz - 4 GHz

### Outline Drawing

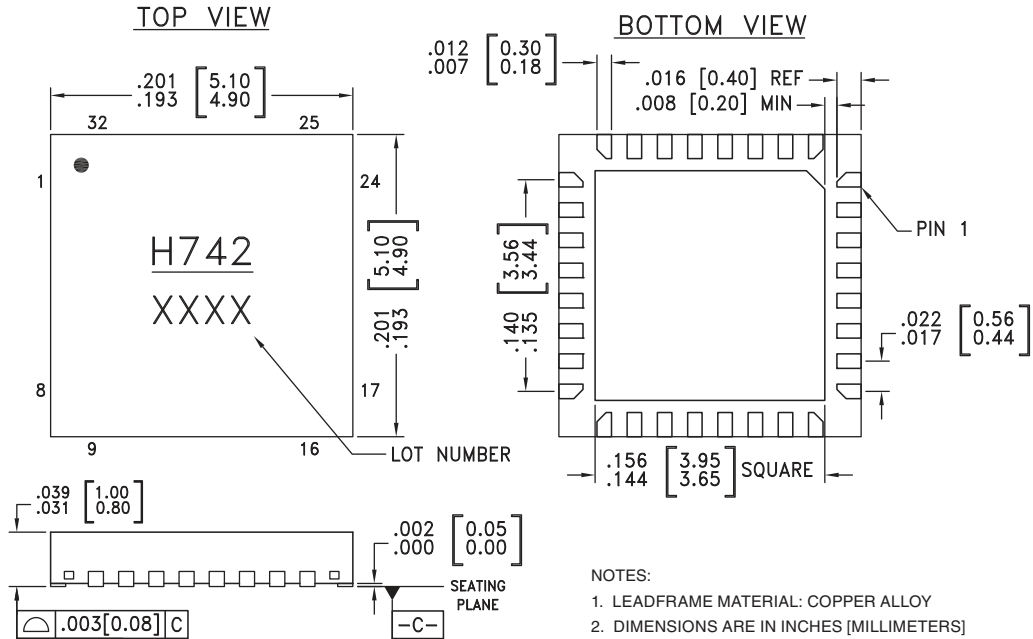

NOTES:

1. LEADFRAME MATERIAL: COPPER ALLOY
2. DIMENSIONS ARE IN INCHES [MILLIMETERS]
3. LEAD SPACING TOLERANCE IS NON-CUMULATIVE.
4. PAD BURR LENGTH SHALL BE 0.15mm MAXIMUM.  
PAD BURR HEIGHT SHALL BE 0.05mm MAXIMUM.
5. PACKAGE WARP SHALL NOT EXCEED 0.05mm.
6. ALL GROUND LEADS AND GROUND PADDLE MUST BE SOLDERED TO PCB RF GROUND.
7. REFER TO HITTITE APPLICATION NOTE FOR SUGGESTED LAND PATTERN.

### Package Information

Part Number	Package Body Material	Lead Finish	MSL Rating	Package Marking <sup>[1]</sup>
HMC742LP5E	RoHS-compliant Low Stress Injection Molded Plastic	100% matte Sn	MSL1 <sup>[2]</sup>	H742 XXXX



[1] 4-Digit lot number XXXX

[2] Max peak reflow temperature of 260 °C

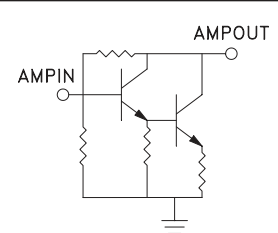

## 0.5 dB LSB GaAs MMIC 6-BIT DIGITAL VARIABLE GAIN AMPLIFIER, 70 MHz - 4 GHz

### Pin Descriptions

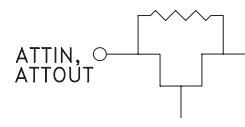
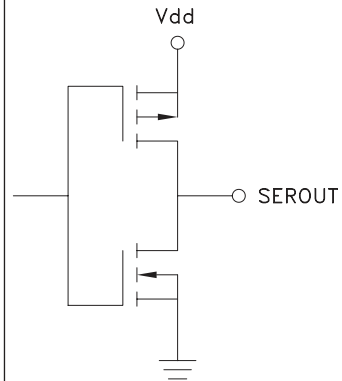
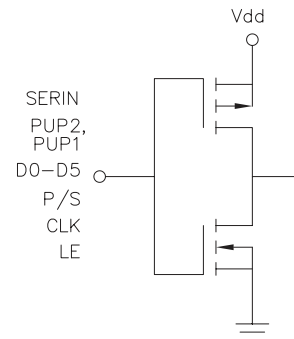
Pin Number	Function	Description	Interface Schematic
1	AMPIN	This pin is DC coupled. An off chip DC blocking capacitor is required.	
29	AMPOUT	RF output and DC bias (Vcc) for the output stage of the amplifier.	
2, 3, 13, 28, 30 - 32	GND	These pins and package bottom must be connected to RF/DC ground.	
4, 12	ATTIN, ATTOUT	These pins are DC coupled and matched to 50 Ohms. Blocking capacitors are required. Select value based on lowest frequency of operation.	
5 - 10	ACG1 - ACG6	External capacitors to ground is required. Select value for lowest frequency of operation. Place capacitor as close to pins as possible.	
11	N/C	No connection	
14	SEROUT	Serial input data delayed by 6 clock cycles.	
15, 16	PUP2, PUP1		
18 - 23	D5, D4, D3, D2, D1, D0		
24	P/S		
25	CLK		
26	SERIN		
27	LE		
17	Vdd	Supply Voltage	

## 0.5 dB LSB GaAs MMIC 6-BIT DIGITAL VARIABLE GAIN AMPLIFIER, 70 MHz - 4 GHz

### Application Circuit

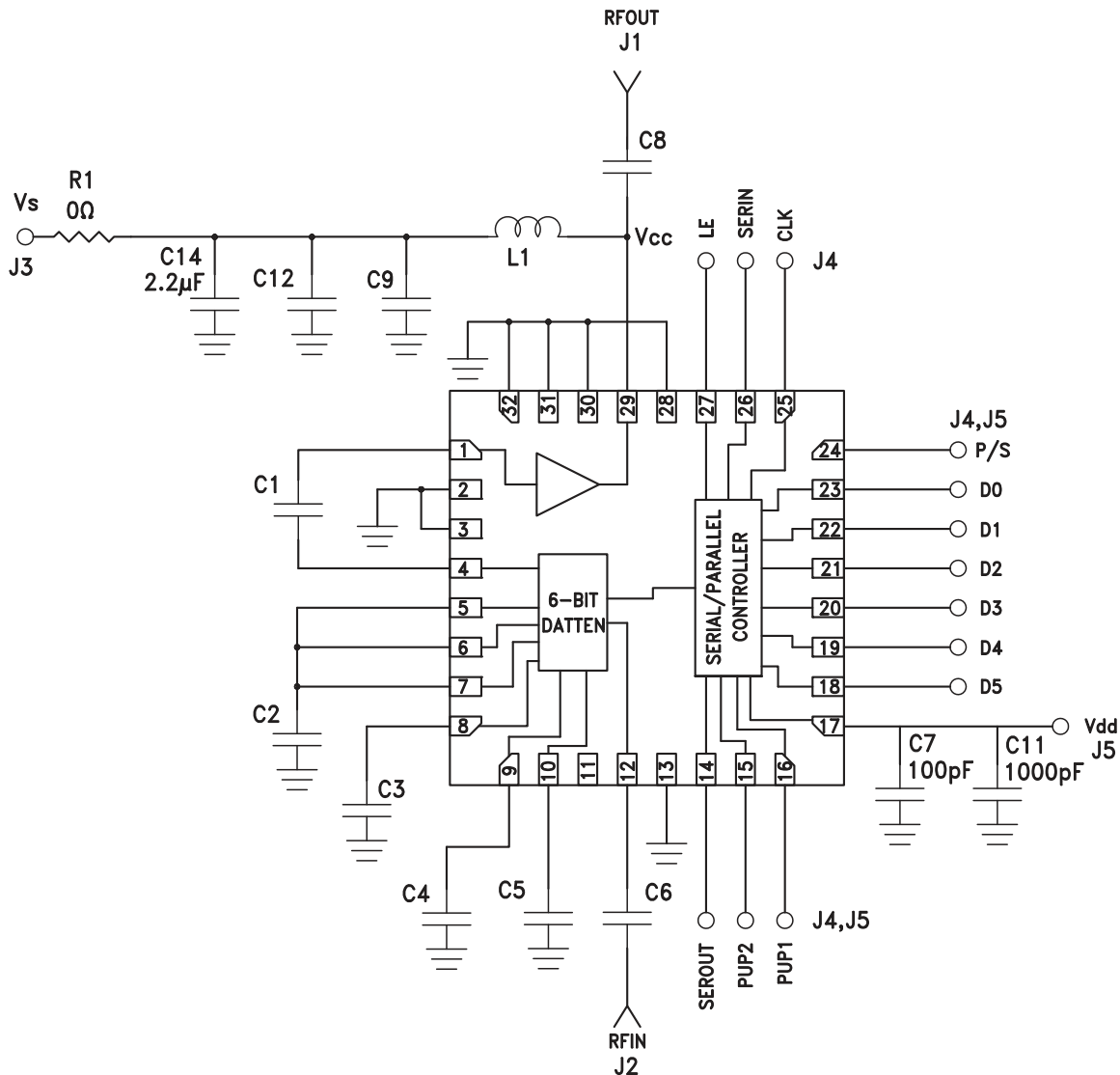

### Components for Selected Frequencies

Tuned Frequency	70 - 1000 MHz	500 - 4000 MHz
Evaluation PCB	124694 [1]	124695 [1]
C1 ,C6, C8 (pF)	10000	330
C3, C4 (pF)	1000	100
C2, C5 (pF)	1000	N/A
C9 (pF)	1000	100
C12 (pF)	5600	1000
L1 (nH)	560	47

[1] Reference this number when ordering complete evaluation PCB



**0.5 dB LSB GaAs MMIC 6-BIT DIGITAL VARIABLE GAIN AMPLIFIER, 70 MHz - 4 GHz**

**Evaluation PCB**

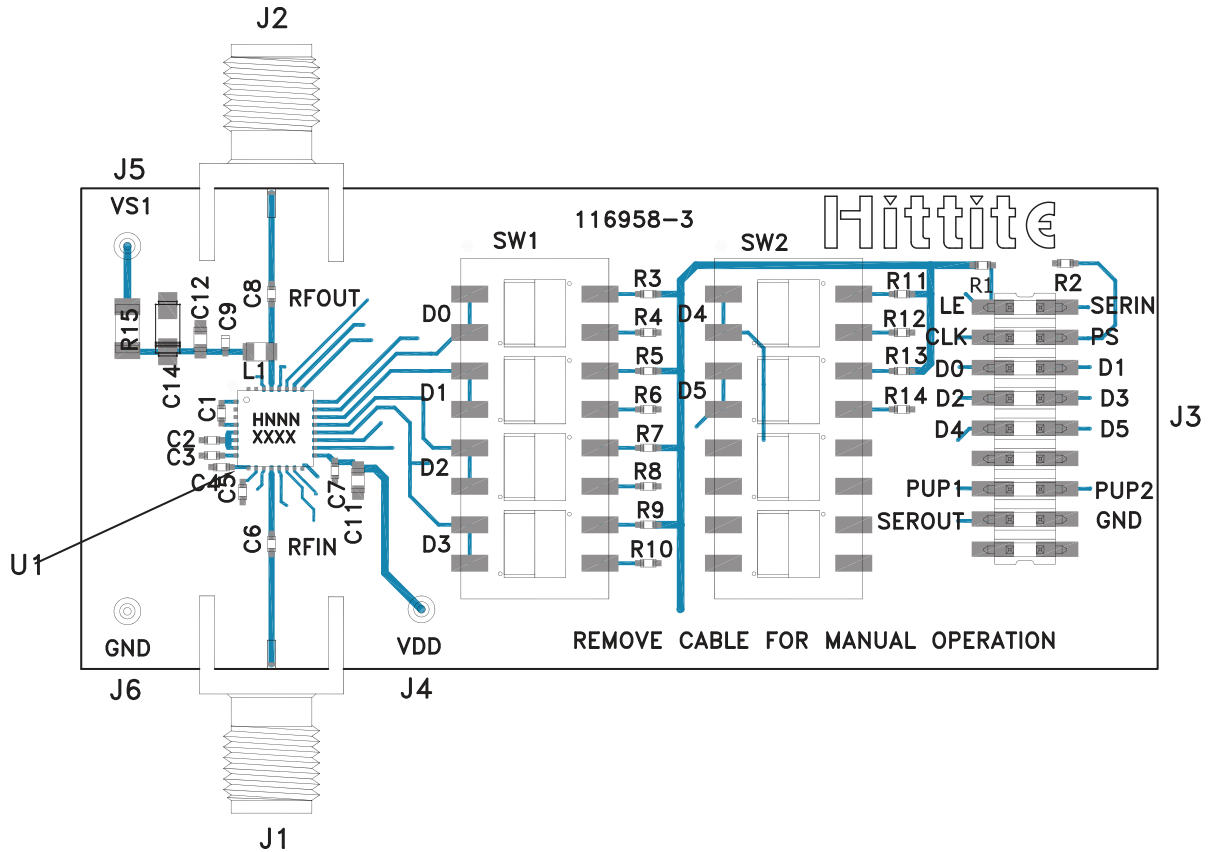

**List of Materials for Evaluation PCB [2]**

Item	Description
J1 - J2	PCB Mount SMA Connectors
J3	18 Pin DC Connector
J4 - J6	DC Pin
C1 - C6, C8, C9	Capacitor, 0402 Pkg. [2]
C7	100pF Capacitor. 0402 Pkg.
C11	1000 pF Capacitor, 0402 Pkg.
C12	Capacitor, 0603 Pkg. [2]
C14	2.2 μF Capacitor, CASE A Pkg.
R1 - R14	100 kOhm Resistor, 0402 Pkg.
R15	0 Ohm Resistor, 1206 Pkg.
L1	Inductor, 0603 Pkg. [2]
SW1, SW2	SPDT 4 Position DIP Switch
U1	HMC742LP5E Variable Gain Amplifier
PCB [1]	116958 Evaluation PCB

[1] Circuit Board Material: Arlon 25FR, FR4

[2] Please reference Components for Selected Frequencies Table shown on previous page.

The circuit board used in the application should use RF circuit design techniques. Signal lines should have 50 Ohm impedance while the package ground leads and exposed paddle should be connected directly to the ground plane similar to that shown. A sufficient number of via holes should be used to connect the top and bottom ground planes. The evaluation circuit board shown is available from Hittite upon request.



**0.5 dB LSB GaAs MMIC 6-BIT DIGITAL  
VARIABLE GAIN AMPLIFIER, 70 MHz - 4 GHz**

**Notes:**