



Typical Applications

The HMC348LP3 / HMC348LP3E is ideal for:

- 75 Ohm Systems
CATV Signal Distribution, Cable Modem Headend & DBS IF Switching
- 50 Ohm Systems
Basestation Infrastructure & Test Equipment

Features

- High Isolation: >80 dB @ 5 MHz (50 Ohm)
>55 dB @ 1 GHz (50 Ohm)
- “All Off” Isolation State
- Non-Reflective Design, 75 Ohm Terminations
- 3x3 mm SMT Package

Functional Diagram

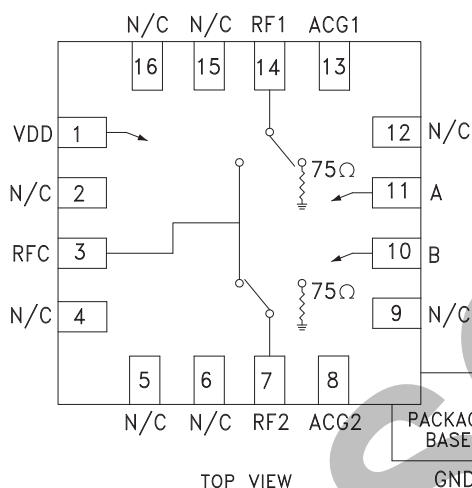

General Description

The HMC348LP3 & HMC348LP3E are non-reflective GaAs MESFET SPDT switches in low cost leadless QFN surface mount plastic packages ideal for CATV applications. Covering DC to 2.5 GHz, the switch offers high isolation, low insertion loss, integrated 75 Ohm terminations and an “all off” state. The switch features >80 dB isolation at 5 MHz and >55 dB isolation up to 1 GHz. The switch operates using complementary positive control voltage logic lines of +5/0V and requires a +5V bias supply (Vdd). This switch offers excellent performance in both 50 Ohm & 75 Ohm systems for either SPDT or SPST functions.

Electrical Specifications, $T_A = +25^\circ\text{C}$, With 0/+5V Control, 50 Ohm System

Parameter	Frequency	Min.	Typ.	Max.	Units
Insertion Loss	DC - 1000 MHz		0.6	0.9	dB
	DC - 2500 MHz		0.7	1.0	dB
Isolation	DC - 250 MHz	63	68		dB
	DC - 750 MHz	53	58		dB
	DC - 1000 MHz	50	55		dB
	DC - 2000 MHz	47	52		dB
	DC - 2500 MHz	45	50		dB
Return Loss	“On State”	DC - 2500 MHz	15	20	dB
Return Loss RF1, RF2	“Off State”	DC - 1000 MHz	9	12	dB
	“Off State”	DC - 2500 MHz	8	11	dB
Input Power for 1 dB Compression	50 MHz	20	23		dBm
	1000 MHz	25	28		dBm
Input Third Order Intercept (Two-Tone Input Power= 0 dBm Each Tone, 6 MHz Tone Separation)	50 MHz		43		dBm
	1000 MHz		48		dBm
	2500 MHz		51		dBm
Input Second Order Intercept (Two-Tone Input Power= 0 dBm Each Tone, 6 MHz Tone Separation)	50 MHz		72		dBm
	1000 MHz		89		dBm
	2500 MHz		80		dBm
Switching Characteristics tRISE, tFALL (10/90% RF) tON, tOFF (50% CTL to 10/90% RF)	DC - 2500 MHz		25		ns
			600		ns

Information furnished by Analog Devices is believed to be accurate and reliable. However, no responsibility is assumed by Analog Devices for its use, nor for any infringements of patents or other rights of third parties that may result from its use. Specifications subject to change without notice. No license is granted by implication or otherwise under any patent or patent rights of Analog Devices. Trademarks and registered trademarks are the property of their respective owners.

For price, delivery, and to place orders: Analog Devices, Inc., One Technology Way, P.O. Box 9106, Norwood, MA 02062-9106 Phone: 781-329-4700 • Order online at www.analog.com Application Support: Phone: 1-800-ANALOG-D



Insertion Loss, 50 Ohm System

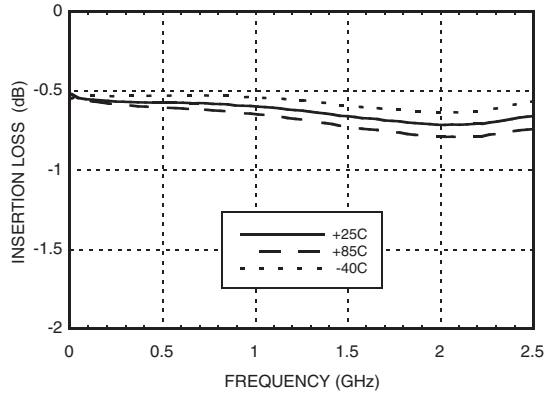

Insertion Loss, 75 Ohm System

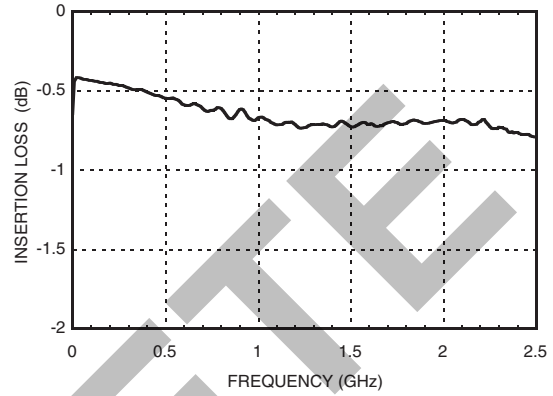

Isolation, 50 Ohm System

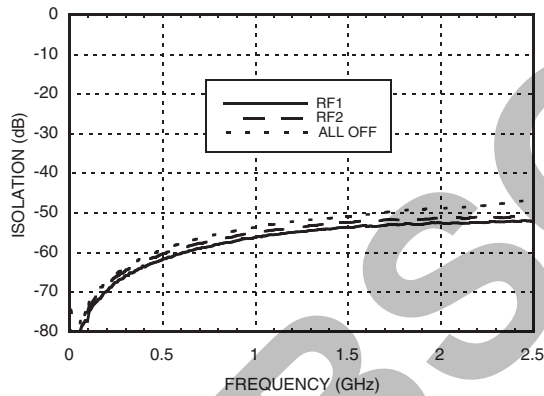

Isolation, 75 Ohm System

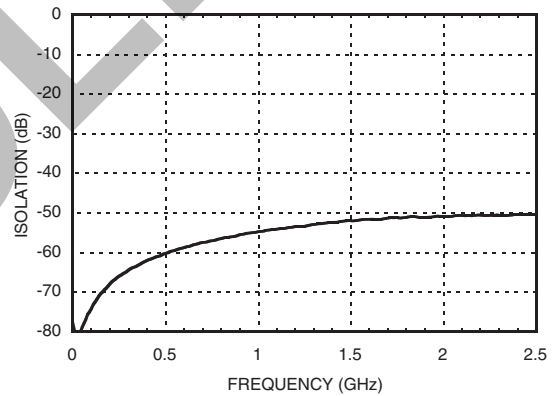

Return Loss, 50 Ohm System

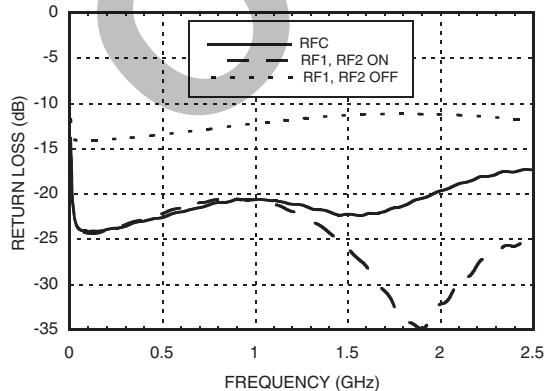

Return Loss, 75 Ohm System

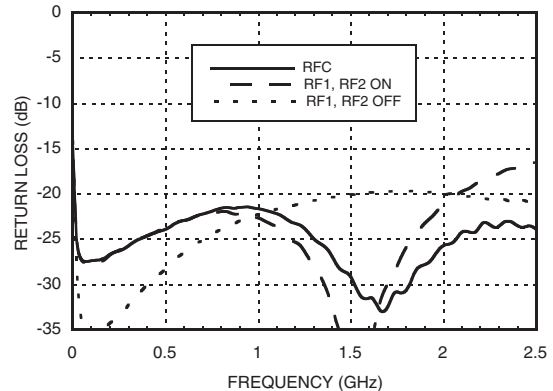

Information furnished by Analog Devices is believed to be accurate and reliable. However, no responsibility is assumed by Analog Devices for its use, nor for any infringements of patents or other rights of third parties that may result from its use. Specifications subject to change without notice. No license is granted by implication or otherwise under any patent or patent rights of Analog Devices. Trademarks and registered trademarks are the property of their respective owners.

For price, delivery, and to place orders: Analog Devices, Inc., One Technology Way, P.O. Box 9106, Norwood, MA 02062-9106 Phone: 781-329-4700 • Order online at www.analog.com Application Support: Phone: 1-800-ANALOG-D



Input Compression Point, 50 Ohm System

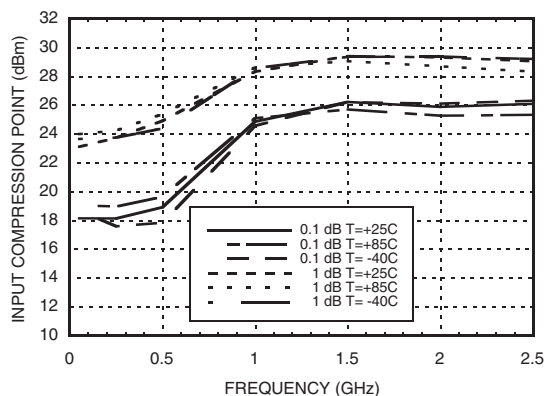

Absolute Maximum Ratings

Bias Voltage Range (Vdd)	+7.0 Vdc
RF Input Power	+30 dBm
Control Voltage Range (A & B)	+0.5V to Vdd + 1.0 Vdc
Channel Temperature	150 °C
Continuous Pdiss (T = 85 °C) (derate 4 mW/°C above 85 °C)	0.3 W
Thermal Resistance (Insertion Loss Path)	104 °C/W
Thermal Resistance (Terminated Path)	240 °C/W
Storage Temperature	-65 to +150 °C
Operating Temperature	-40 to +85 °C
ESD Sensitivity (HBM)	Class 1A



ELECTROSTATIC SENSITIVE DEVICE
OBSERVE HANDLING PRECAUTIONS

Bias Voltage & Current

Vdd Range = +5.0 Vdc ±10%		
Vdd (Vdc)	Idd (Typ.) (mA)	Idd (Max.) (mA)
+5.0	1.1	2.2

Truth Table

Control Input		Signal Path State	
A	B	RFC to RF1	RFC to RF2
High	Low	On	Off
Low	High	Off	On
Low	Low	Off	Off

Control Voltages

State	Bias Condition
Low	0 to +0.8V @ 5 uA Typical
High	+2.0 to +5.0 Vdc @ 35 uA Typical



Outline Drawing

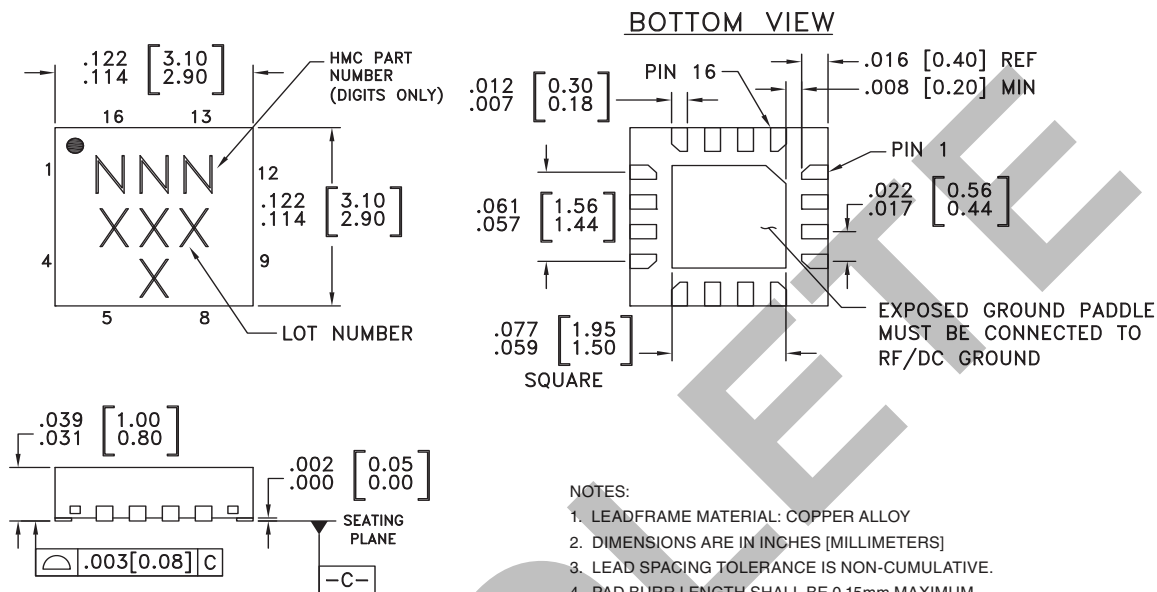

Package Information

Part Number	Package Body Material	Lead Finish	MSL Rating	Package Marking ^[3]
HMC348LP3	Low Stress Injection Molded Plastic	Sn/Pb Solder	MSL1 ^[1]	348 XXXX
HMC348LP3E	RoHS-compliant Low Stress Injection Molded Plastic	100% matte Sn	MSL1 ^[2]	348 XXXX

[1] Max peak reflow temperature of 235 °C

[2] Max peak reflow temperature of 260 °C

[3] 4-Digit lot number XXXX



Pin Descriptions

Pin Number	Function	Description	Interface Schematic
1	Vdd	Supply Voltage +5V ±10%	
2, 4, 5, 6, 9, 12, 15, 16	N/C	These pins should be connected to PCB RF ground to maximize isolation.	
3, 7, 14	RFC, RF1, RF2	These pins are DC coupled and matched to 75 Ohms. Blocking capacitors are required.	
8, 13	ACG1, ACG2	External capacitors to ground are required. Select value for optimal isolation below 500 MHz.	
10	B	See truth table and control voltage table.	
11	A	See truth table and control voltage table.	

Application Circuit

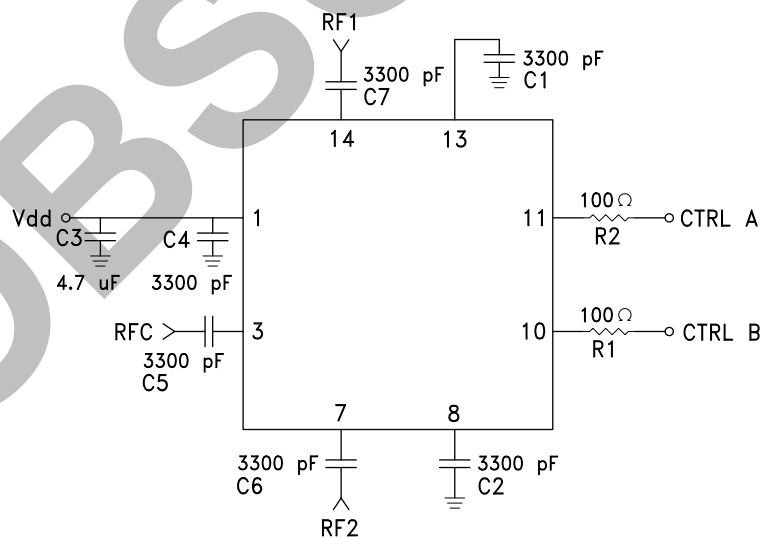

The value of capacitors C1 & C2 are critical for low frequency isolation performance below 500 MHz. 3300 pF 0402 size capacitors are recommended for optimal isolation down to 5 MHz. If the frequency of operation is above 500 MHz then 100 pF to 300 pF 0402 capacitors will be sufficient.

Information furnished by Analog Devices is believed to be accurate and reliable. However, no responsibility is assumed by Analog Devices for its use, nor for any infringements of patents or other rights of third parties that may result from its use. Specifications subject to change without notice. No license is granted by implication or otherwise under any patent or patent rights of Analog Devices. Trademarks and registered trademarks are the property of their respective owners.

For price, delivery, and to place orders: Analog Devices, Inc., One Technology Way, P.O. Box 9106, Norwood, MA 02062-9106 Phone: 781-329-4700 • Order online at www.analog.com Application Support: Phone: 1-800-ANALOG-D



Evaluation PCB (50 Ohms)

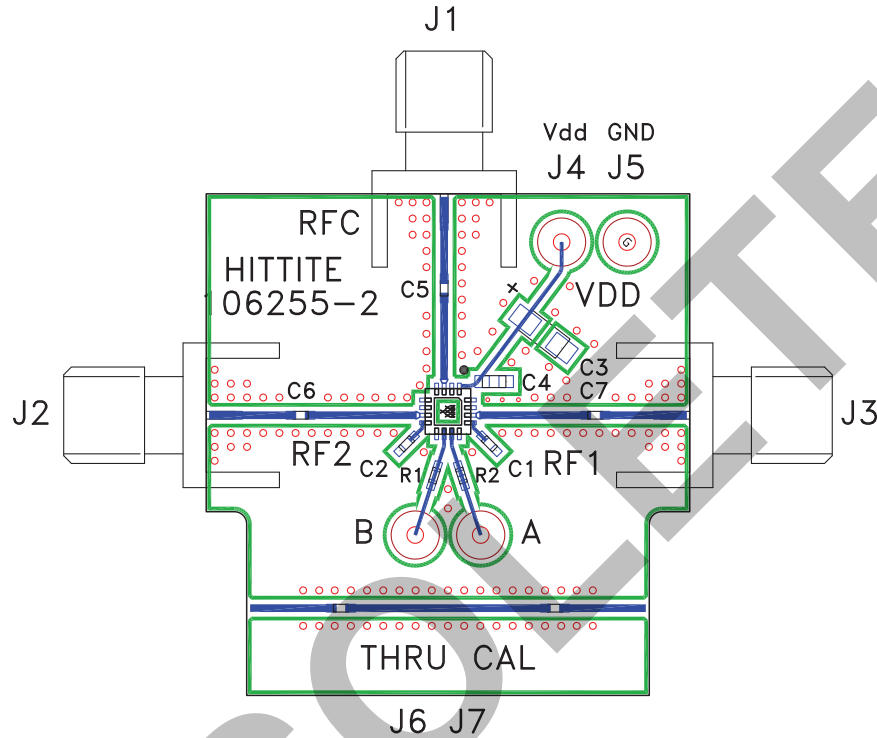

List of Materials for Evaluation PCB 106343 [1]

Item	Description
J1 - J3	PCB Mount SMA RF Connector
J4 - J7	DC Pin
R1 - R2	100 Ohm Resistor, 0402 Pkg.
C1, C2, C4 - C7	3300 pF Capacitor, 0402 Pkg.
C3	4.7 uF Tantalum Capacitor
U1	HMC348LP3 / HMC348LP3E SPDT Switch
PCB [2]	106255 Evaluation PCB

[1] Reference this number when ordering complete evaluation PCB

[2] Circuit Board Material: Rogers 4350

The circuit board used in the final application should be generated with proper RF circuit design techniques. Signal lines at the RF port should have 50 ohm impedance and the package ground leads and package bottom should be connected directly to the ground plane similar to that shown above. The evaluation circuit board shown above is available from Hittite Microwave Corporation upon request.