

CAA573X7R1E157M670LH

TDK item description : CAA573X7R1E157MT***



Application & Main Feature

Commercial grade (MEGACAP (Low resistance/Inline))

Series

CAA573(5750) [EIA 2220]

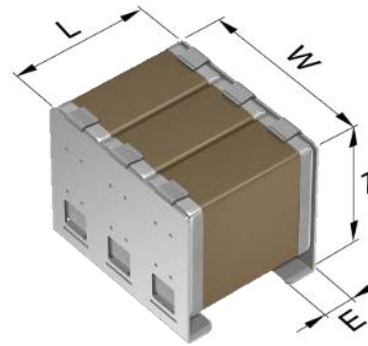

Dimensions

L 6.25±0.50 mm
W 7.50±0.50 mm
T 6.70±0.50 mm
E 1.20±0.20 mm

Temperature Characteristic

X7R (-55 to +125 degC, ±15%)

Rated Voltage

1E (25Vdc)

Capacitance

150µF

Capacitance Tolerance

M (±20%)

DF

5 % max.

Insulation Resistance

3 Mohm min.

AEC-Q200

Not Applicable

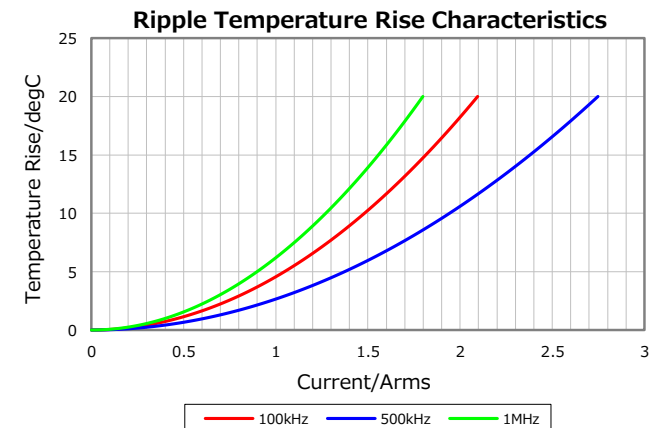
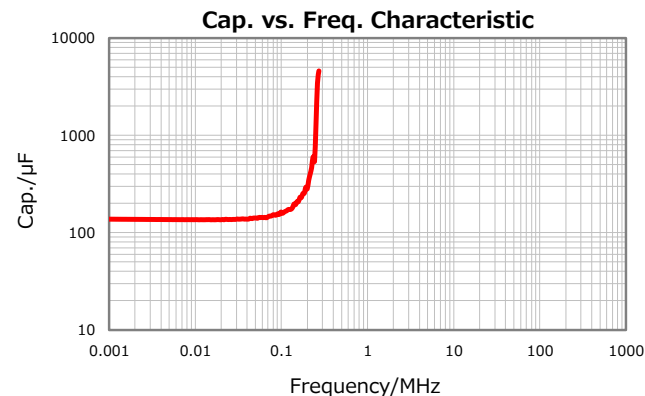
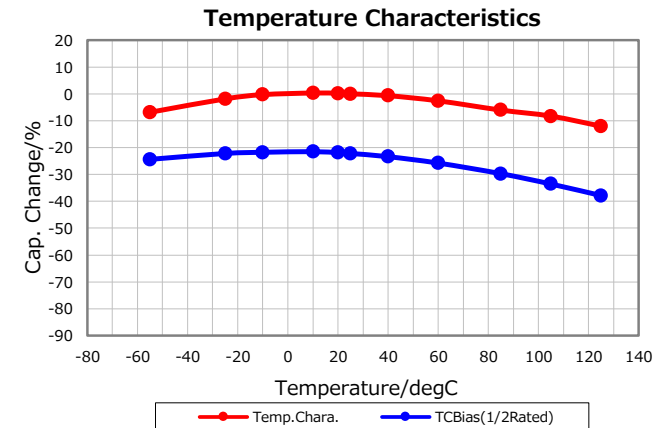
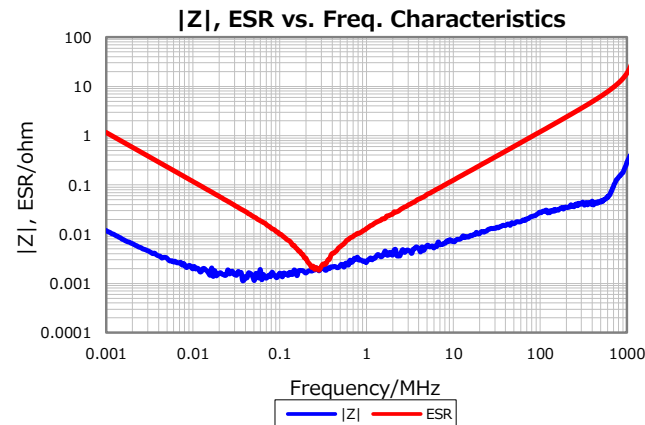
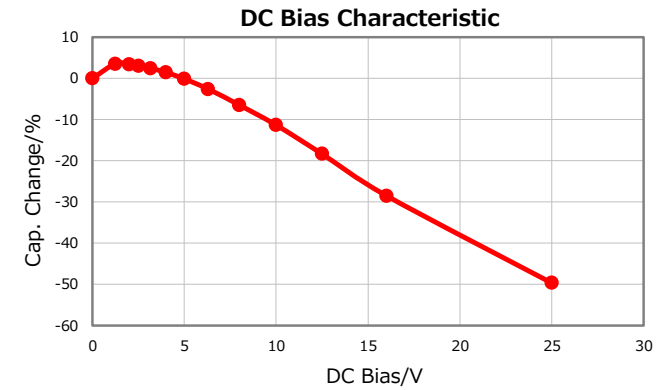

Characterization Sheet (Multilayer Ceramic Chip Capacitors)



⚠ All specifications are subject to change without notice.

July 1, 2022