

NOTE:
 1. MATERIAL:
 1.1 USB-C PLUG CONN (P/N:10133475)
 1.2 PCB (CUSTOMIZED)
 2. LEAD FREE PRODUCT MEETS EUROPEAN UNION DIRECTIVES AND OTHER COUNTRY REGULATIONS AS DISCRIBLED IN GS-22-008
 3. PRODUCT IS HALOGEN FREE PRODUCTS.
 4. DIMENSIONING SHALL BE INTERPRETED PER ANSI Y14.5-2009;
 5. THIS DESIGN COMPLY WITH UNIVERSAL SERIAL BUS TYPE-C SPECIFICATION

PART MUNBER CODE: 10144277 - X 0 0 0 X LF

CONN OPTION

- 0. 10133475-10000LF
- 1. 10133475-10001LF

PCB AND ELECTRON COMPONENT OPTION

- 2: WITH PCB STYLE 2 (REF SHEET 2)
- 3: WITH PCB STYLE 3 (REF SHEET 3)
- 4: WITH PCB STYLE 4 (REF SHEET 4)
- 5: WITH PCB STYLE 5 + FEMALE HEADER 10 POS CONN (REF SHEET 5)
- 6: WITH PCB STYLE 6 + HEADER 10POS CONN+ RESISTORS (REF SHEET 6)
- 7: WITH PCB STYLE 7 (REF SHEET 7)
- 8: WITH PCB STYLE 8 (REF SHEET 8)

Amphenol FCI

© 2020 Amphenol Corporation

spec ref -		dr	Li-Qing Lei	2017/06/13	projection 	mm 	size	A3	scale	1.000	
tolerance std ISO 406 ISO 1101		TOLERANCES UNLESS OTHERWISE SPECIFIED					eng	Li-Qing Lei	2021/08/05	ecn no	ELX-N-41918-1
surface ISO 1302		chr	-	-			appr	Tim Yao	2021/08/30	product family	rel level
linear	0.X	±0.35	Amphenol FCI	USB Type-C		dwg no	10144277		rev	F	
	0.XX	±0.25		CABLE PLUG KITS							
angular	0°	±2°		cat. no.	Product - Customer Drw						sheet 1 of 8

PART MUMBER
10144277-20000LF

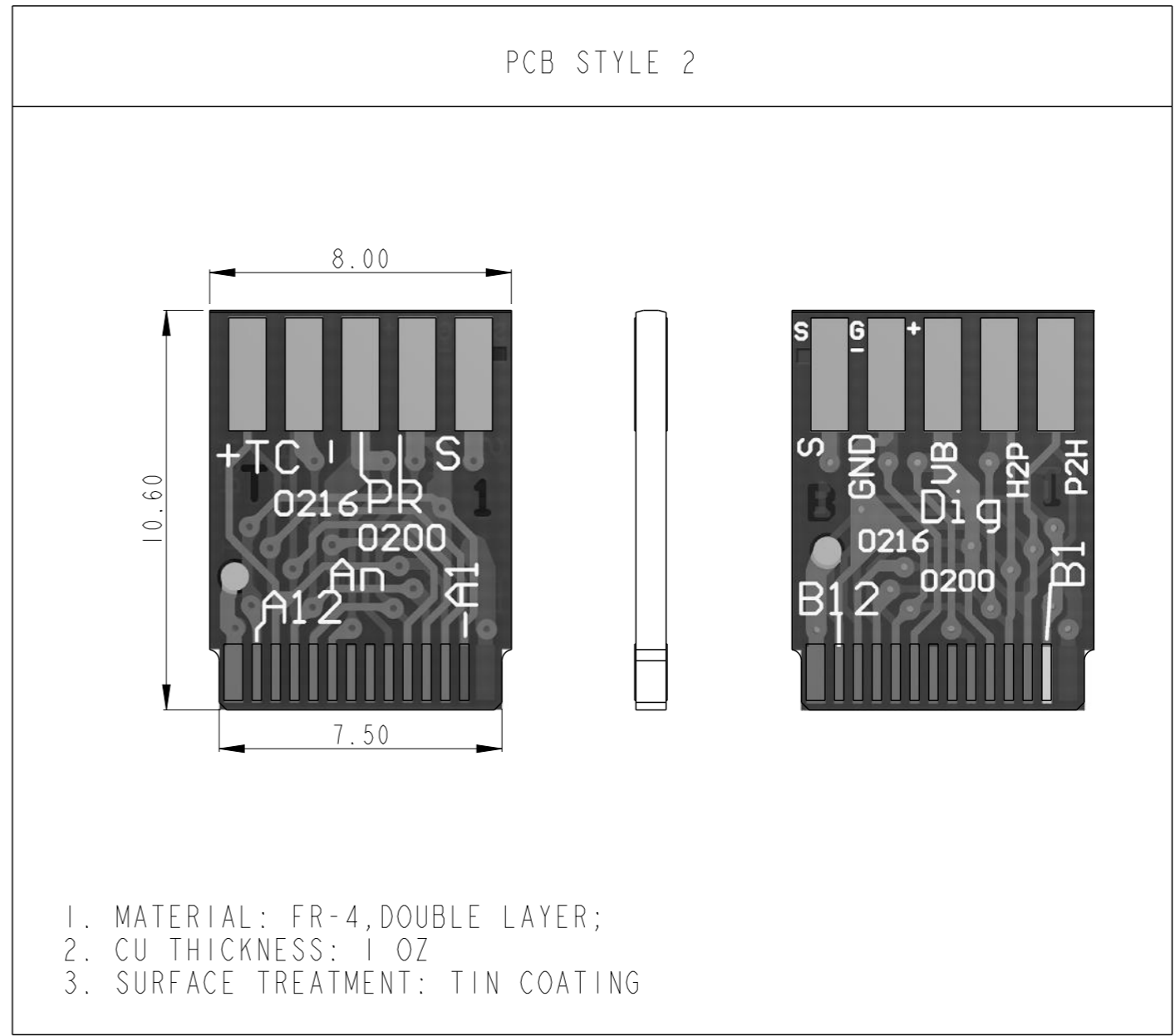
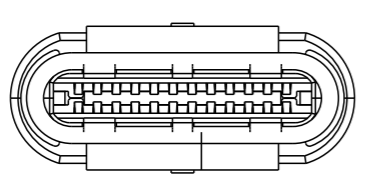
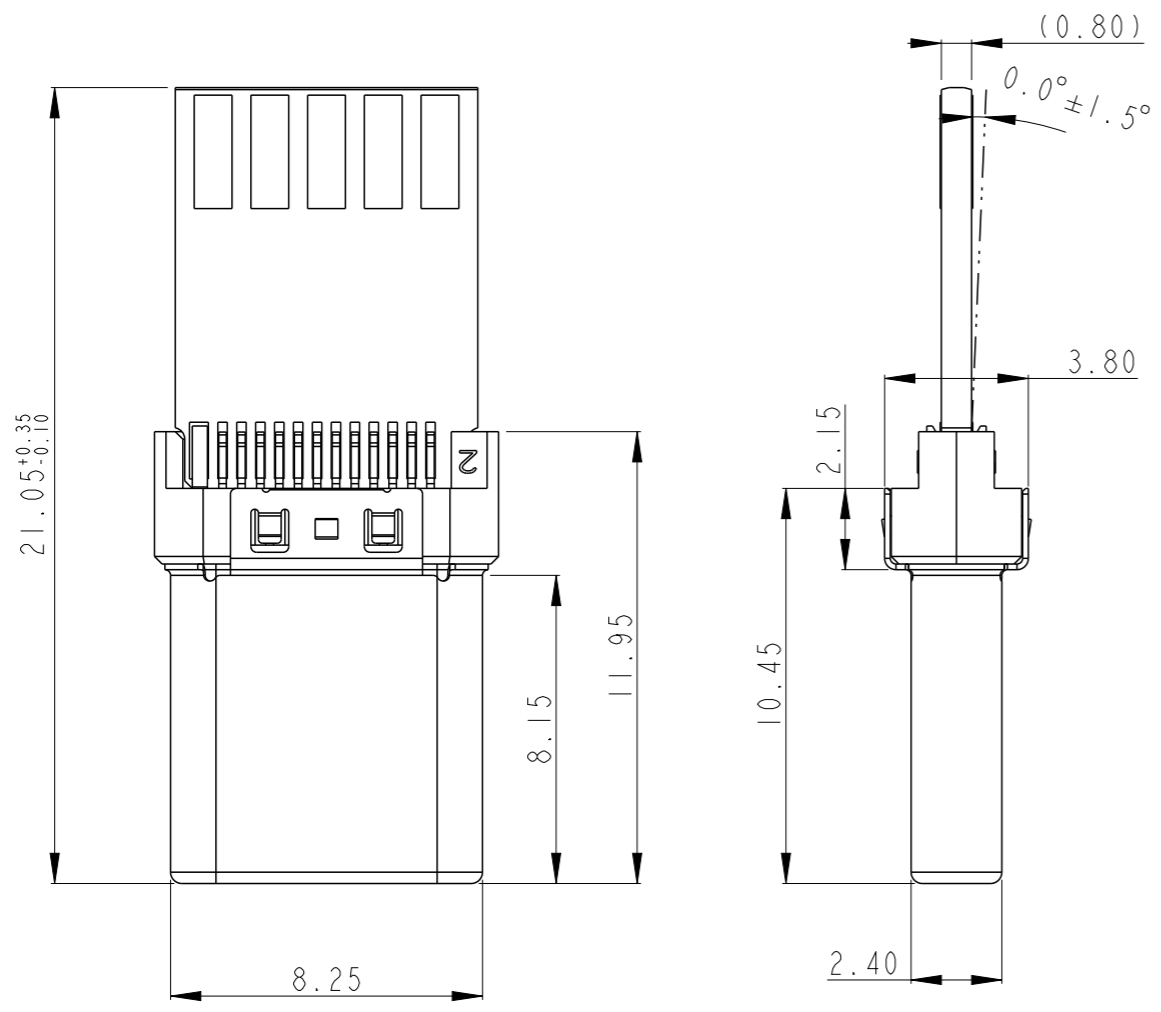

Amphenol
FCi

© 2020 Amphenol Corporation

spec ref -		dr	Li-Qing Lei	2017/06/13	projection 	mm ←→	size	A3	scale	5.000
tolerance std ISO 406 ISO 1101		eng	Li-Qing Lei	2021/08/05			ecn no	ELX-N-41918-1		
TOLERANCES UNLESS OTHERWISE SPECIFIED		chr	-	-			rel level	Released		
surface	linear	0.X	±0.35	Amphenol FCi	USB Type-C CABLE PLUG KITS	dwg no	10144277	rev	F	
		0.XX	±0.25							
		0.XXX	±0.15							
ISO 1302	angular	0°	±2°	cat. no.	Product - Customer Drw	sheet 2 of 8				

PART MUMBER
10144277-30000LF

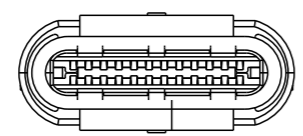
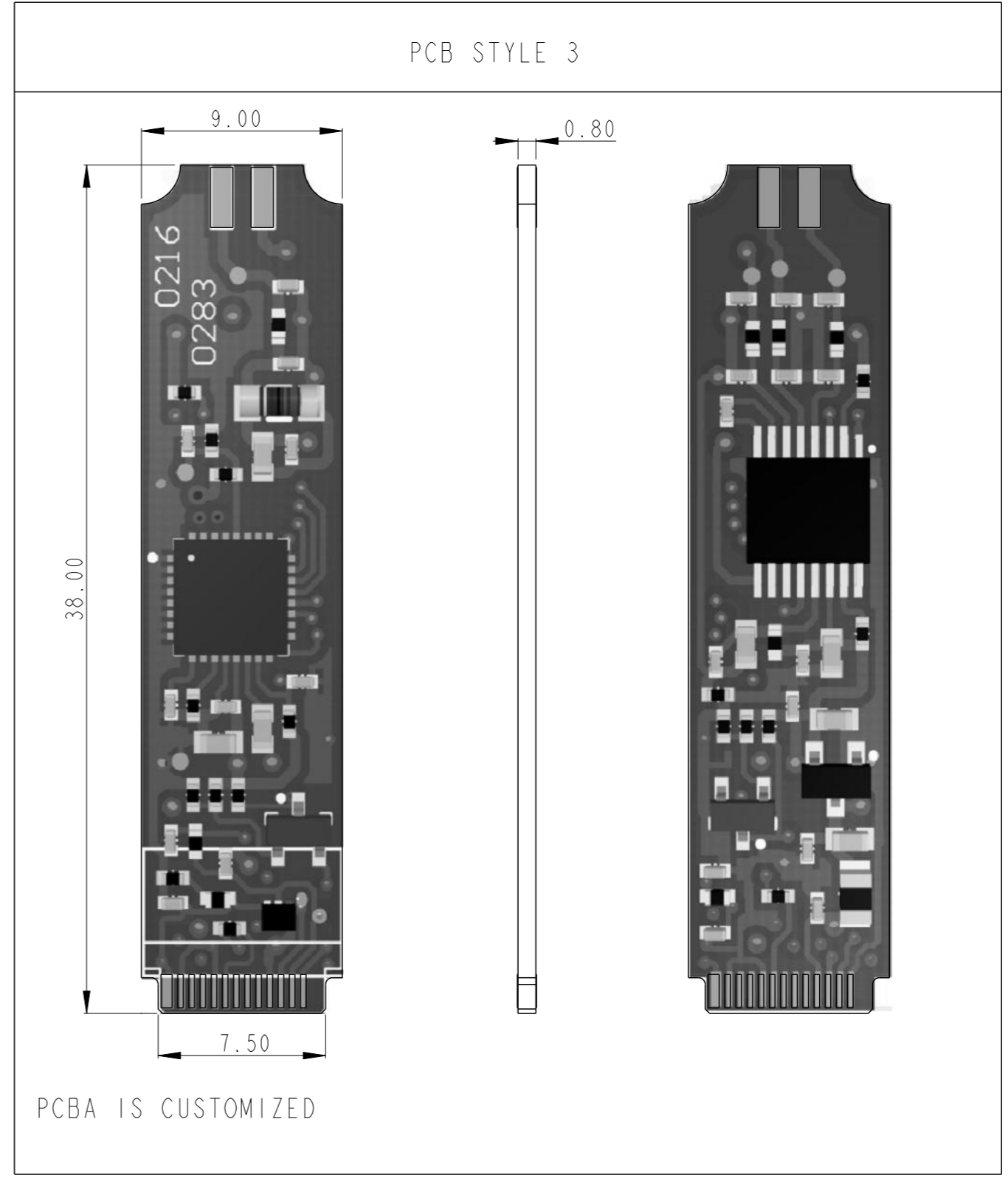
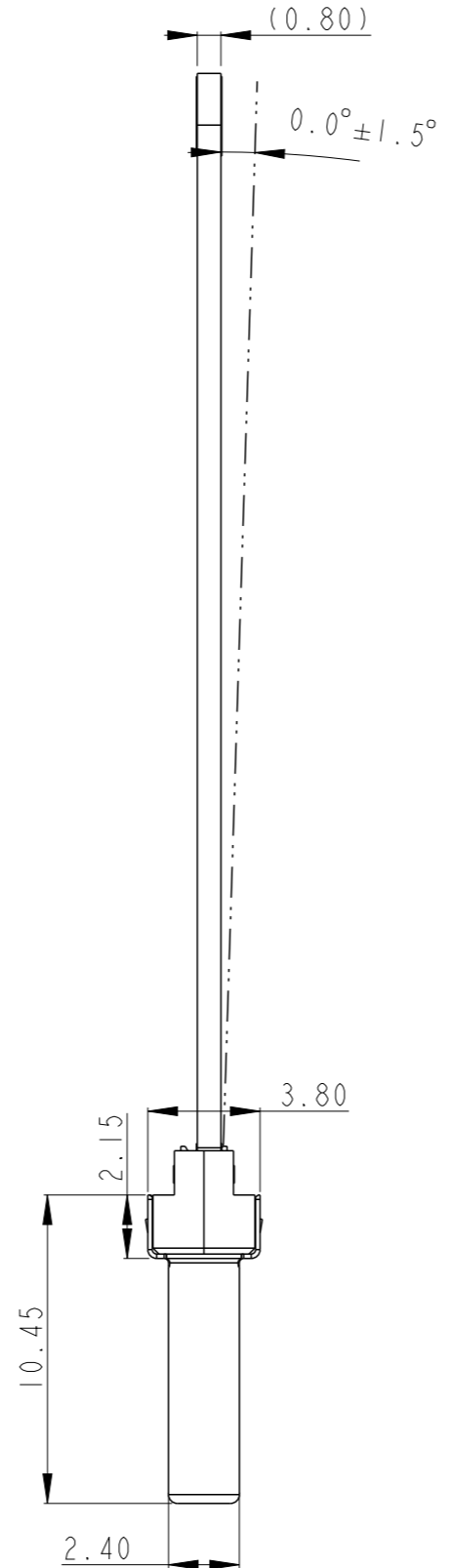
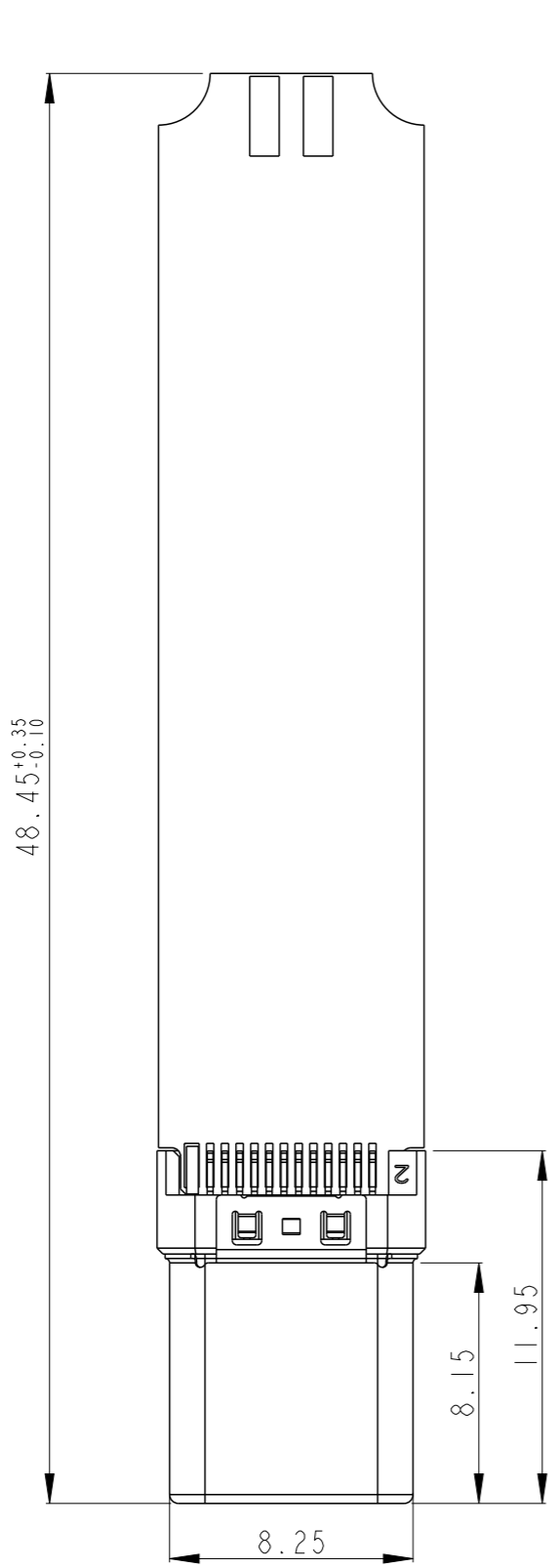

spec ref	-
tolerance std	ISO 406 ISO 1101
surface	ISO 1302
linear	0.X ±0.35
	0.XX ±0.25
angular	0.XXX ±0.15
	0° ±2°

dr	Li-Qing Lei	2017/06/13
eng	Li-Qing Lei	2021/08/05
chr	-	-
appr	Tim Yao	2021/08/30

projection	mm	size	A3	scale	1.000
product family		ecn no	ELX-N-41918-1		
		rel level	Released		
title	USB Type-C CABLE PLUG KITS		dwg no	10144277	
cat. no.	Product - Customer Drw		rev	F	
			sheet 3 of 8		

PART NUMBER
10144277-40000LF

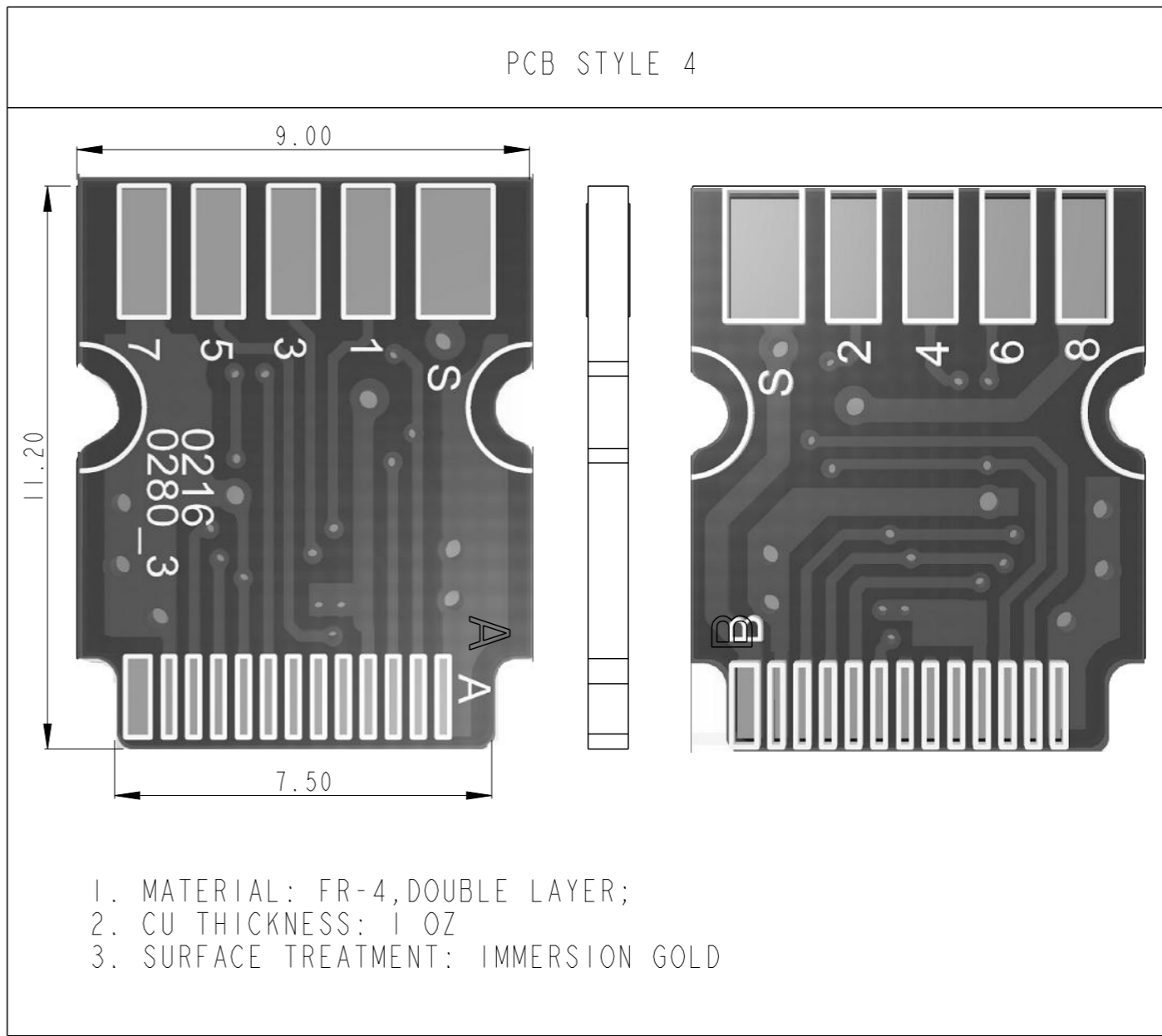
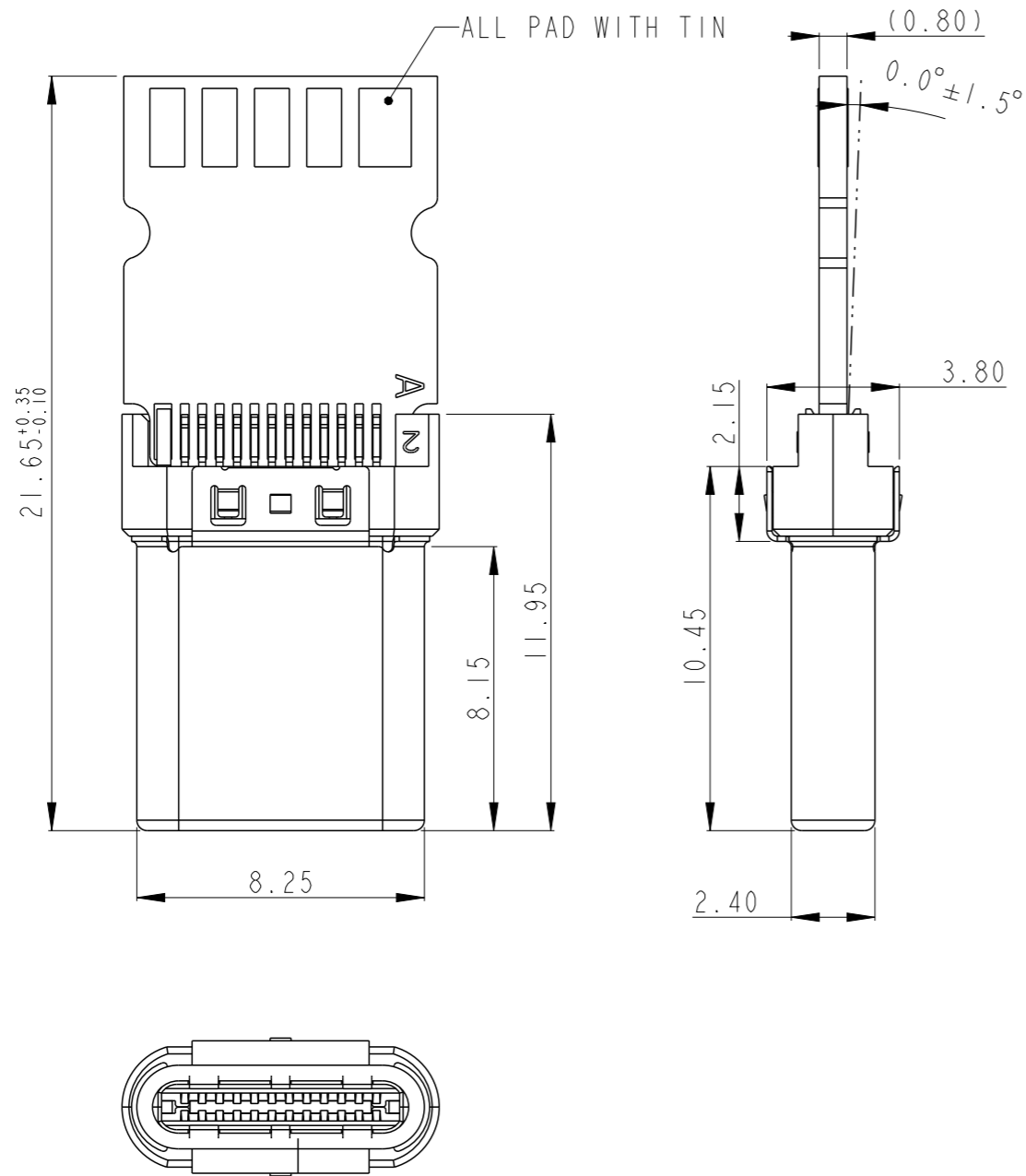

Amphenol
FCi

© 2020 Amphenol Corporation

spec ref -		dr Li-Qing Lei	2017/06/13	projection 	mm ←→	size A3	scale 4.000
tolerance std ISO 406 ISO 1101		eng Li-Qing Lei	2021/08/05			ecn no ELX-N-41918-1	rel level Released
surface ISO 1302	linear	0.X	±0.35	Amphenol FCi	title USB Type-C CABLE PLUG KITS	dwg no 10144277	rev F
		0.XX	±0.25				
0.XXX	±0.15						
	angular	0°	±2°	cat. no.	Product - Customer Drw	sheet 4 of 8	

Creo File:ELX-WC-A3C.REV F.2020-12-21

PART MUMBER
10144277-50000LF

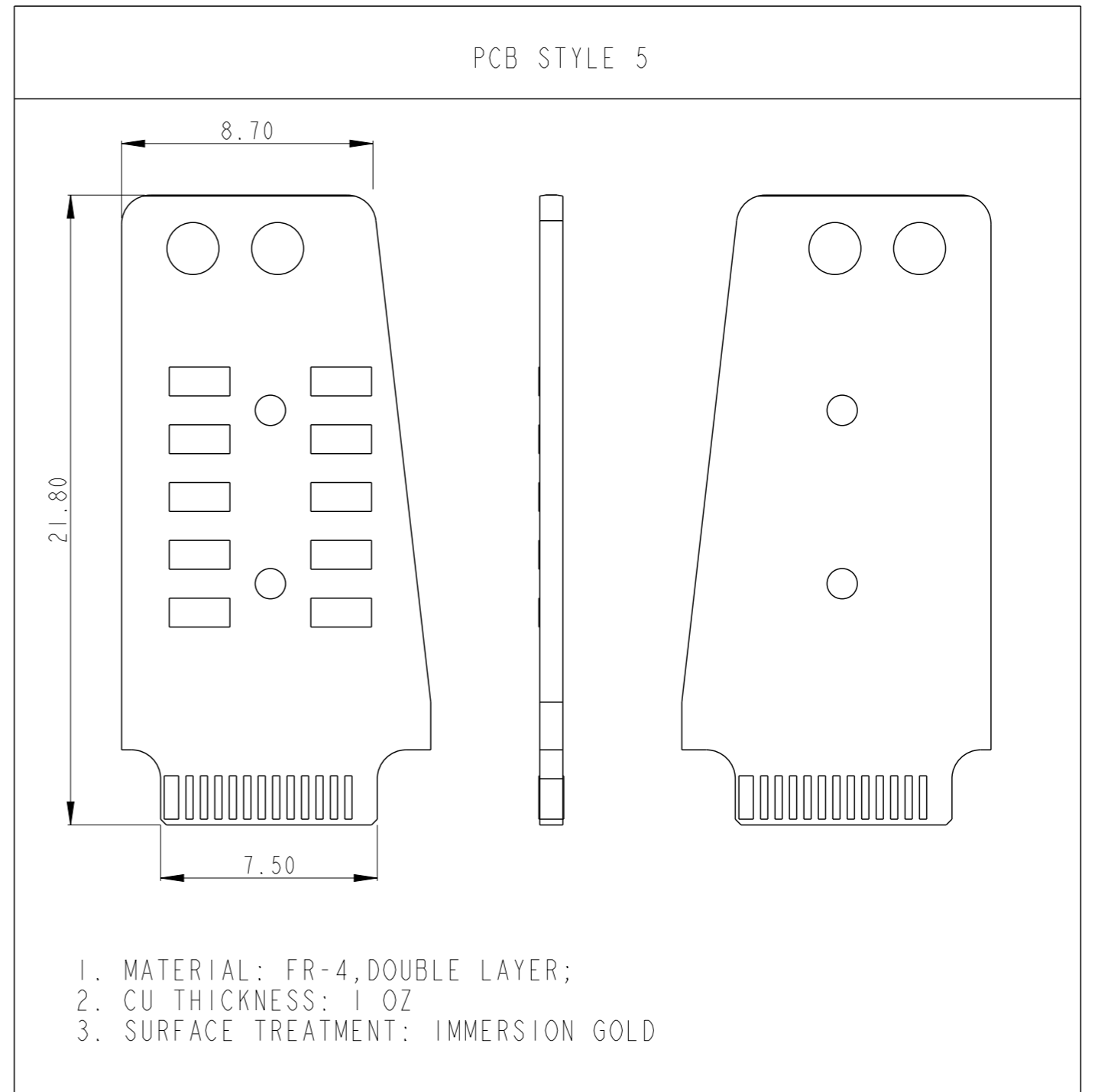
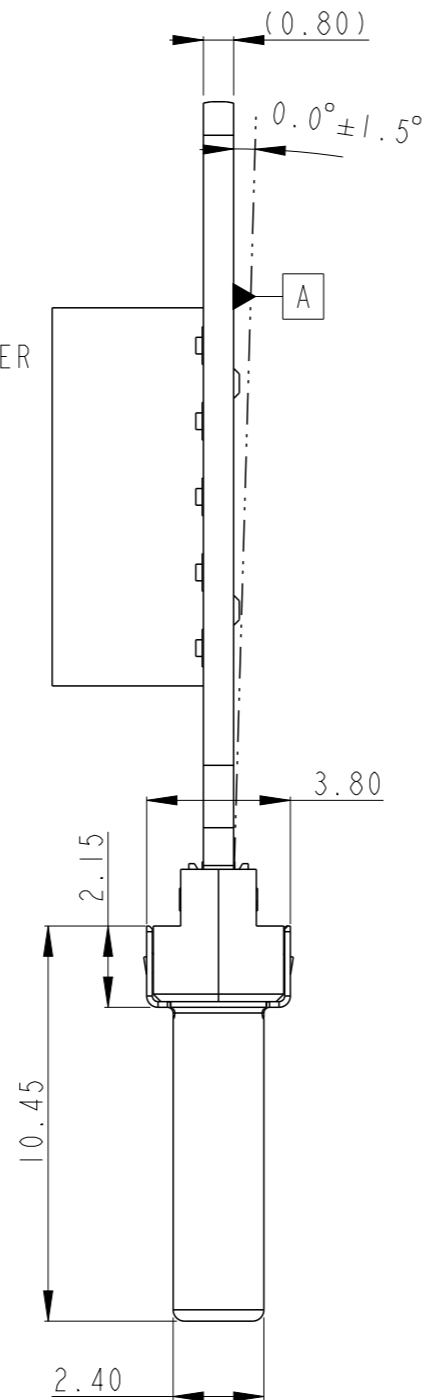
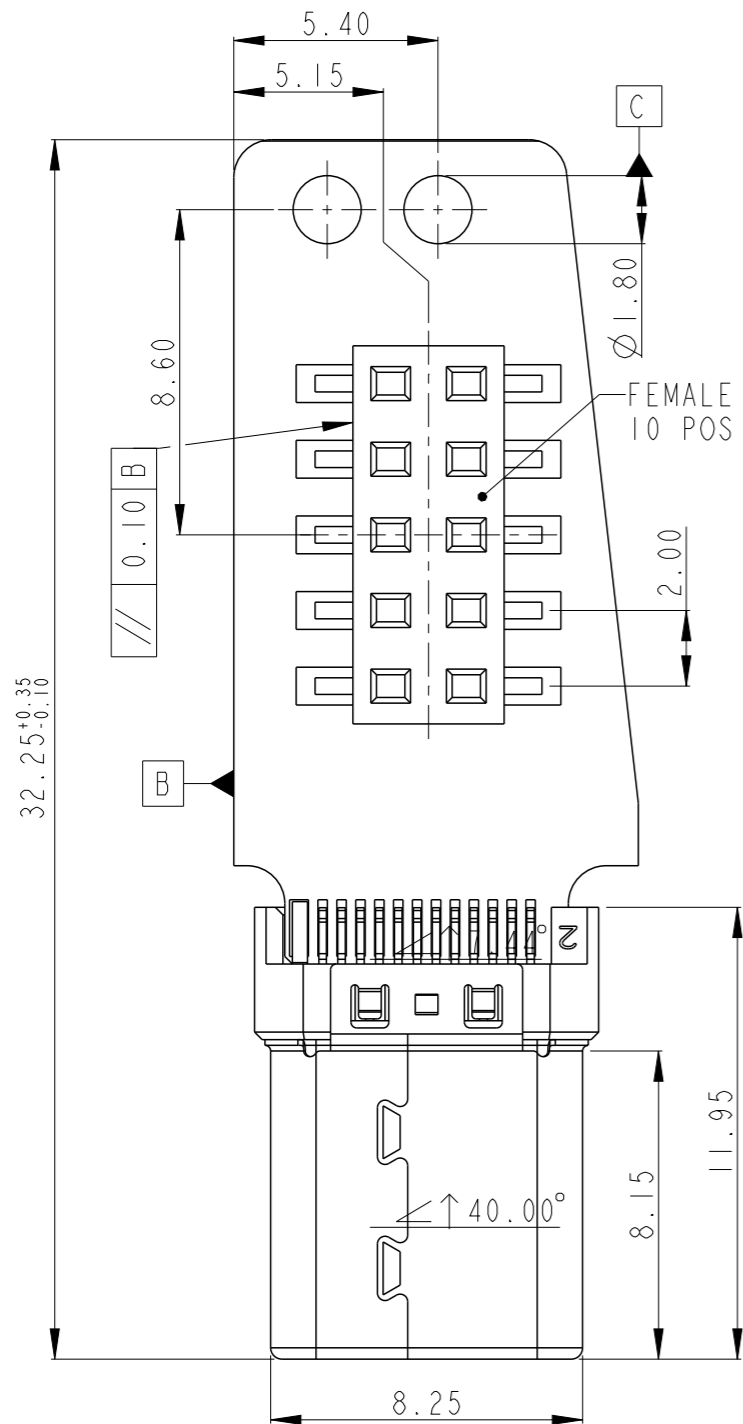

spec ref	-	dr	Li-Qing Lei	2017/06/13	projection	mm	size	A3	scale	1.000	
tolerance std	ISO 406 ISO 1101	eng	Li-Qing Lei	2021/08/05			ecn no	ELX-N-41918-1			
TOLERANCES UNLESS OTHERWISE SPECIFIED		chr	-	-			rel level	Released			
surface	linear	0.X	±0.35	Amphenol FCI	product family		dwg no	10144277		rev	F
		0.XX	±0.25		USB Type-C						
		0.XXX	±0.15		CABLE PLUG KITS						
ISO 1302	angular	0°	±2°	cat. no.	Product - Customer Drw			sheet 5 of 8			

PART MUMBER
10144277-60000LF

A

B

C

D

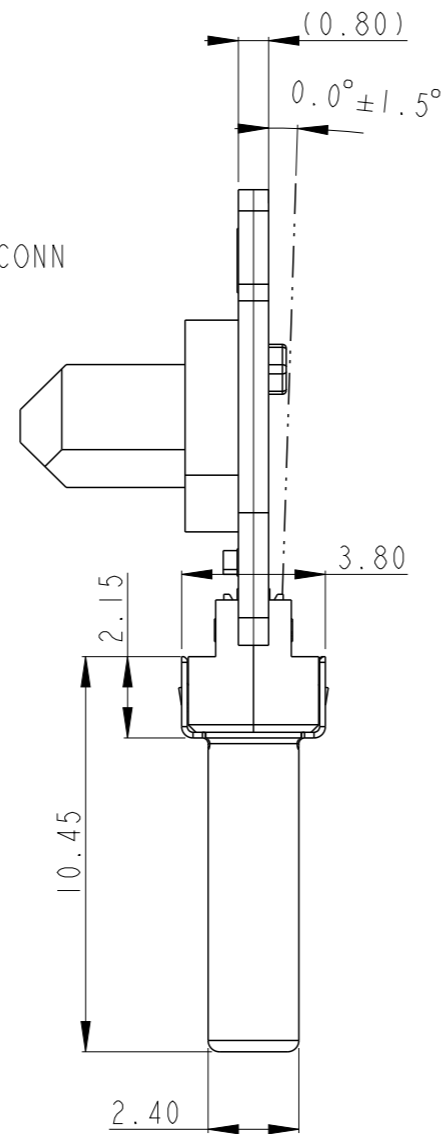
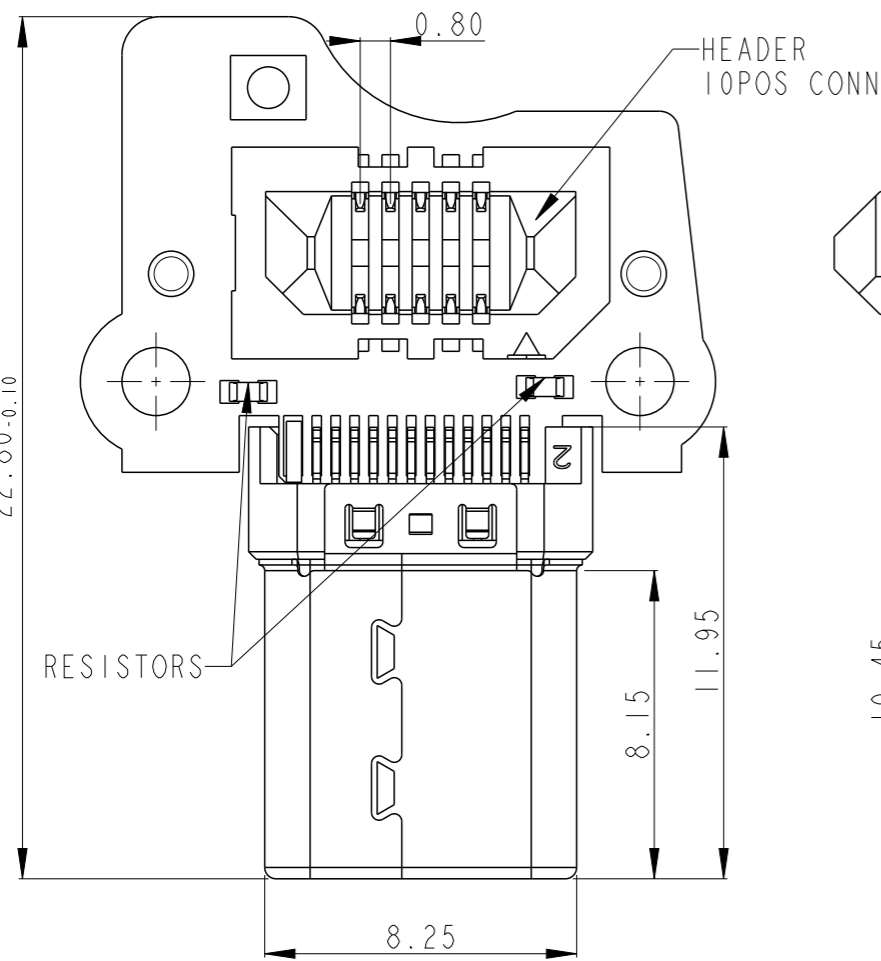

PCB STYLE 6

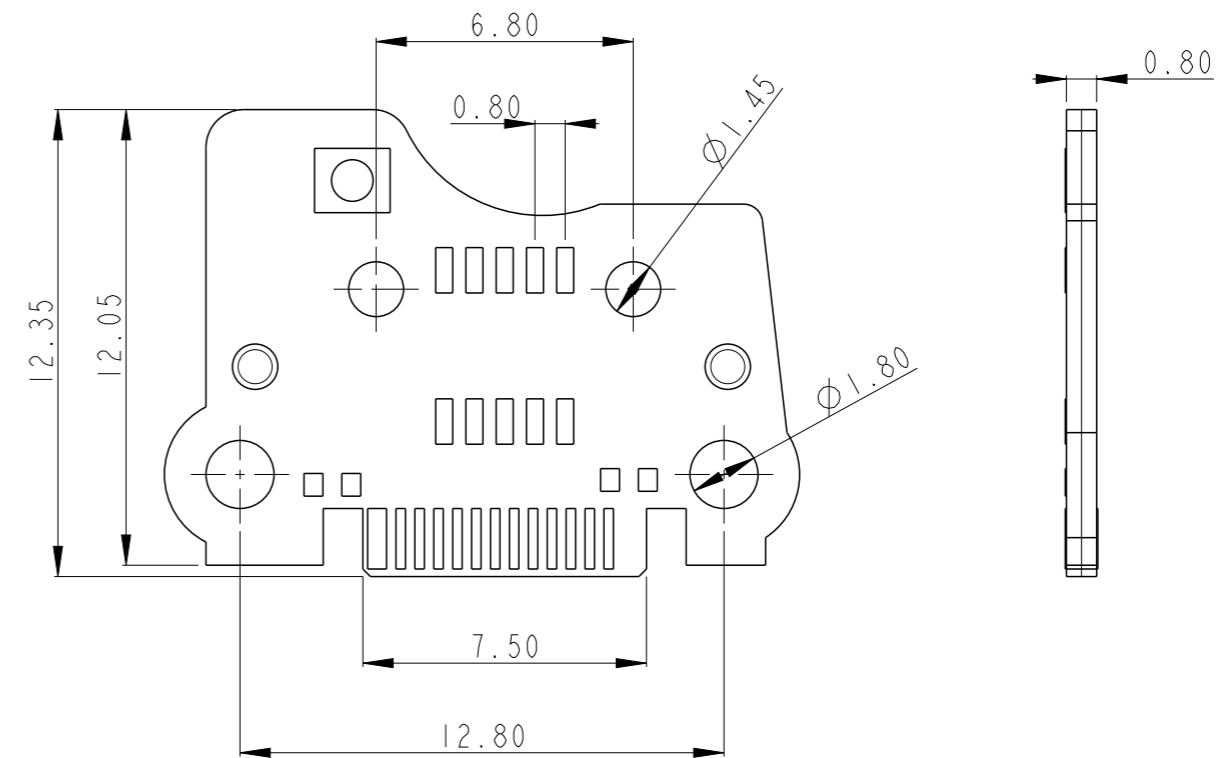

1. MATERIAL: FR-4, DOUBLE LAYER;
2. CU THICKNESS: 1 OZ
3. SURFACE TREATMENT: IMMERSION GOLD

A

B

C

D

spec ref -		dr	Li-Qing Lei	2017/06/13	projection	mm	size	A3	scale	1.000
tolerance std ISO 406 ISO 1101		eng	Li-Qing Lei	2021/08/05			ecn no	ELX-N-41918-1		
TOLERANCES UNLESS OTHERWISE SPECIFIED		chr	-	-		product family	rel level	Released		
		appr	Tim Yao	2021/08/30	USB Type-C CABLE PLUG KITS		dwg no	10144277	rev	F
surface	linear	0.X	±0.35	Amphenol FCi	cat. no.	Product - Customer Drw		sheet 6 of 8		
		0.XX	±0.25							
		0.XXX	±0.15							
ISO 1302	angular	0°	±2°							

PART MUMBER	COLOR OF THE DOT
10144277-70000LF	BLACK
10144277-70001LF	WHITE

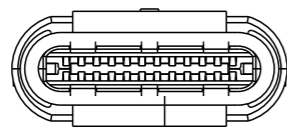
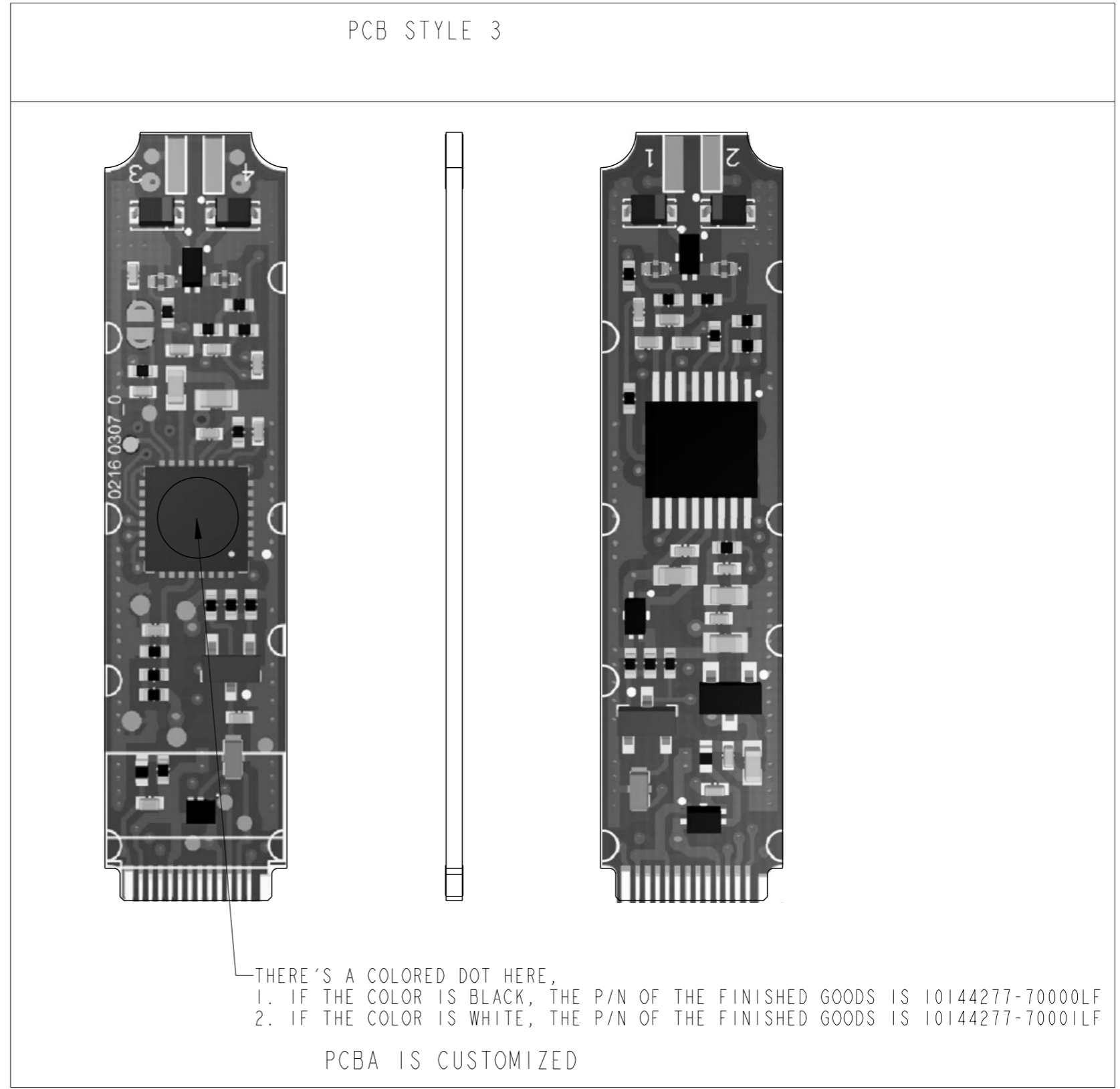
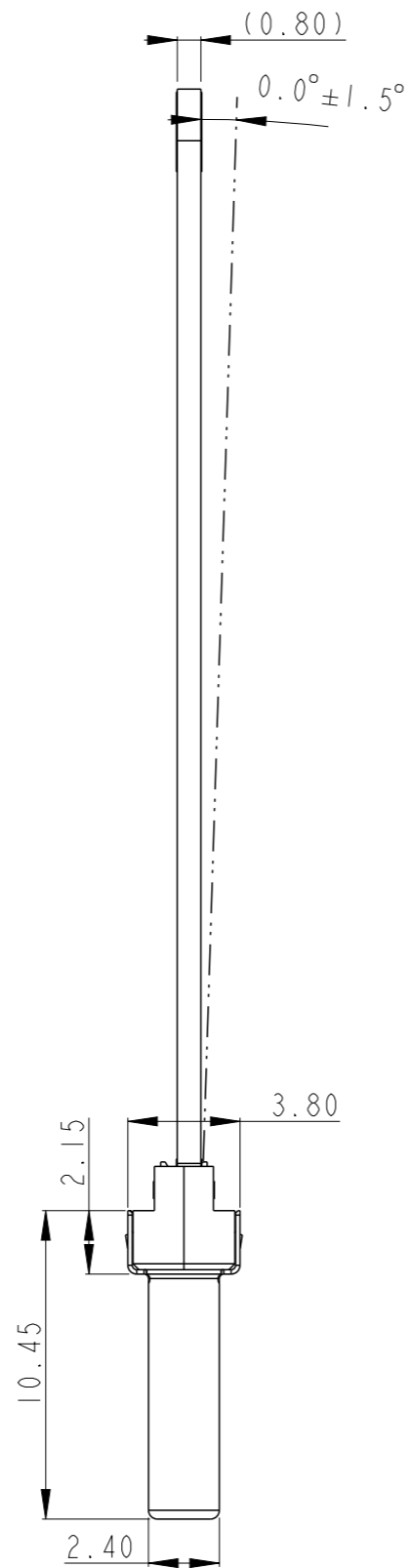
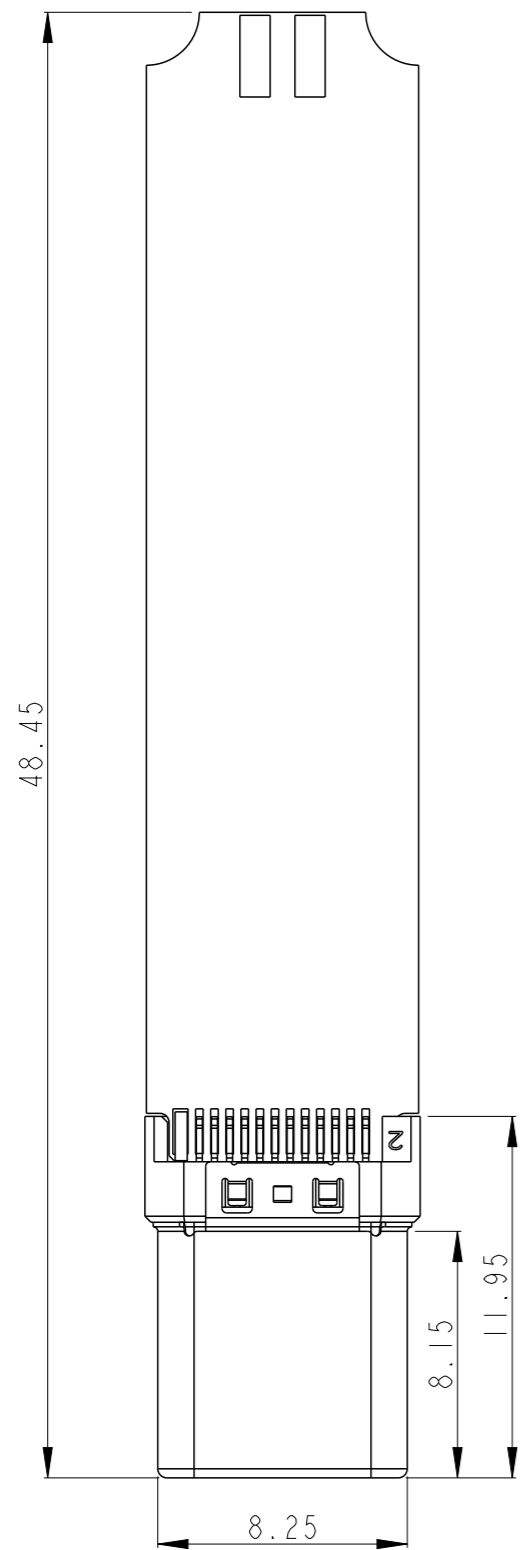

spec ref	-	dr	Li-Qing Lei	2017/06/13	projection	mm	size	A3	scale	1.000					
tolerance std	ISO 406 ISO 1101	eng	Li-Qing Lei	2021/08/05			ecn no	ELX-N-41918-1							
TOLERANCES UNLESS OTHERWISE SPECIFIED		chr	-	-			rel level	Released							
surface	linear	appr	Tim Yao	2021/08/30	product family		rel level	Released							
	0.X	±0.35	Amphenol FCI			USB Type-C CABLE PLUG KITS		dwg no 10144277		rev	F				
	0.XX	±0.25								cat. no.		Product - Customer Drw		sheet 7 of 8	
	0.XXX	±0.15													
ISO 1302	angular	0°	±2°												

PART NUMBER
10144277-80000LF

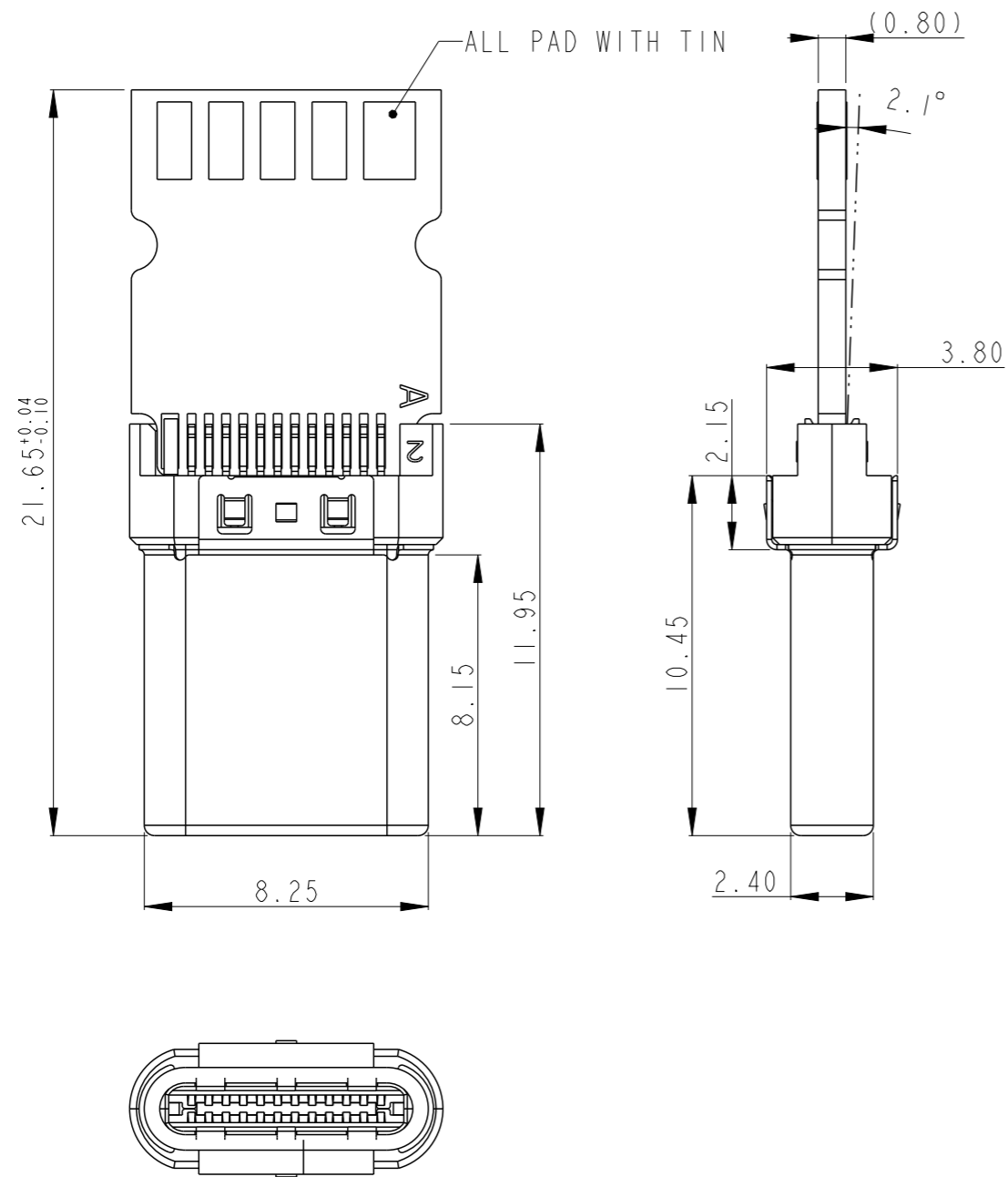

PCB STYLE 8

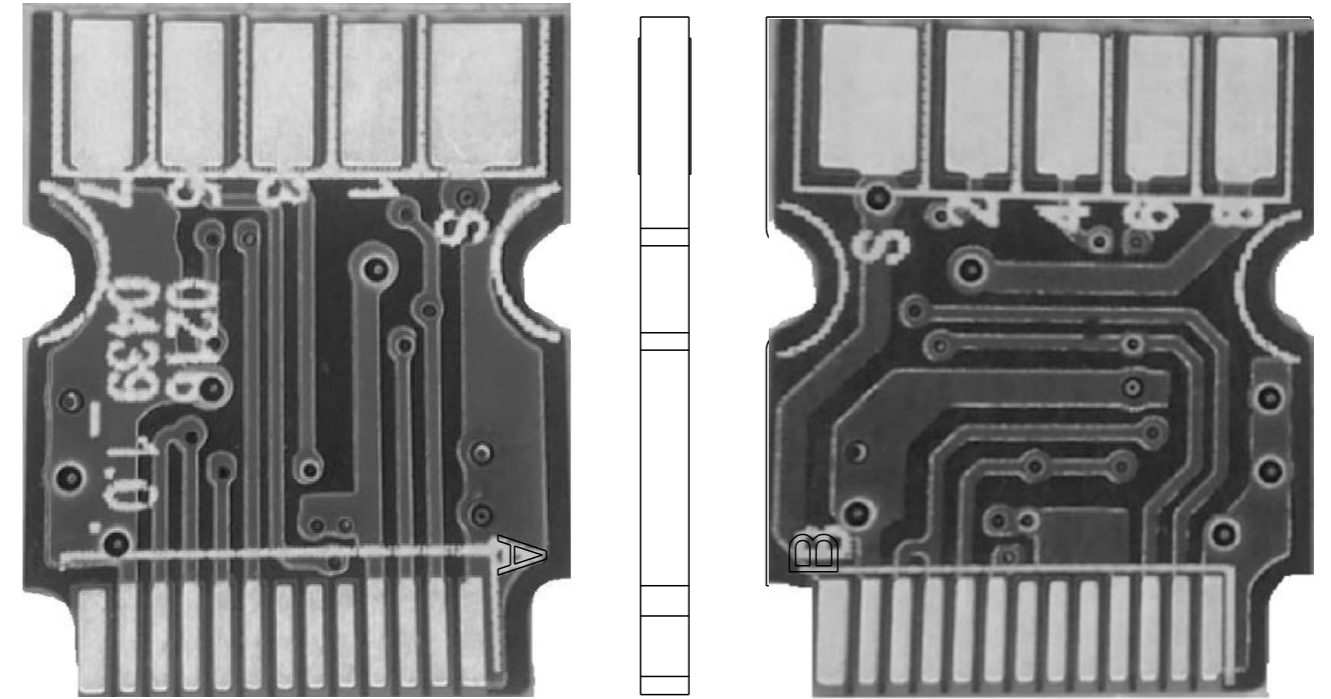

1. MATERIAL: FR-4, DOUBLE LAYER;
2. CU THICKNESS: 1 OZ
3. SURFACE TREATMENT: IMMERSION GOLD

Amphenol
FCi

© 2020 Amphenol Corporation

spec ref -		dr	Li-Qing Lei	2017/06/13	projection 	mm ←→	size	A3	scale	4.000	
tolerance std ISO 406 ISO 1101		eng	Li-Qing Lei	2021/08/05			ecn no	ELX-N-41918-1			
TOLERANCES UNLESS OTHERWISE SPECIFIED		chr	-	-	product family		rel level	Released			
surface	linear	0.X	±0.35	Amphenol FCi	USB Type-C CABLE PLUG KITS		dwg no	10144277		rev	F
		0.XX	±0.25								
0.XXX	±0.15										
ISO 1302	angular	0°	±2°	cat. no.	Product - Customer Drw		sheet 8 of 8				