



Power Key 5.0

TE Internal #: 2-1376389-3

Rectangular Power Connectors, Housing, Plug, Wire-to-Board, 3 Position, 5 mm [.197 in] Centerline, Wire & Cable, UL 94V-0, Power Key 5.0

[View on TE.com >](#)

Connectors > Power Connectors > Rectangular Power > Rectangular Power Connectors > STD Temp Power Key Plug

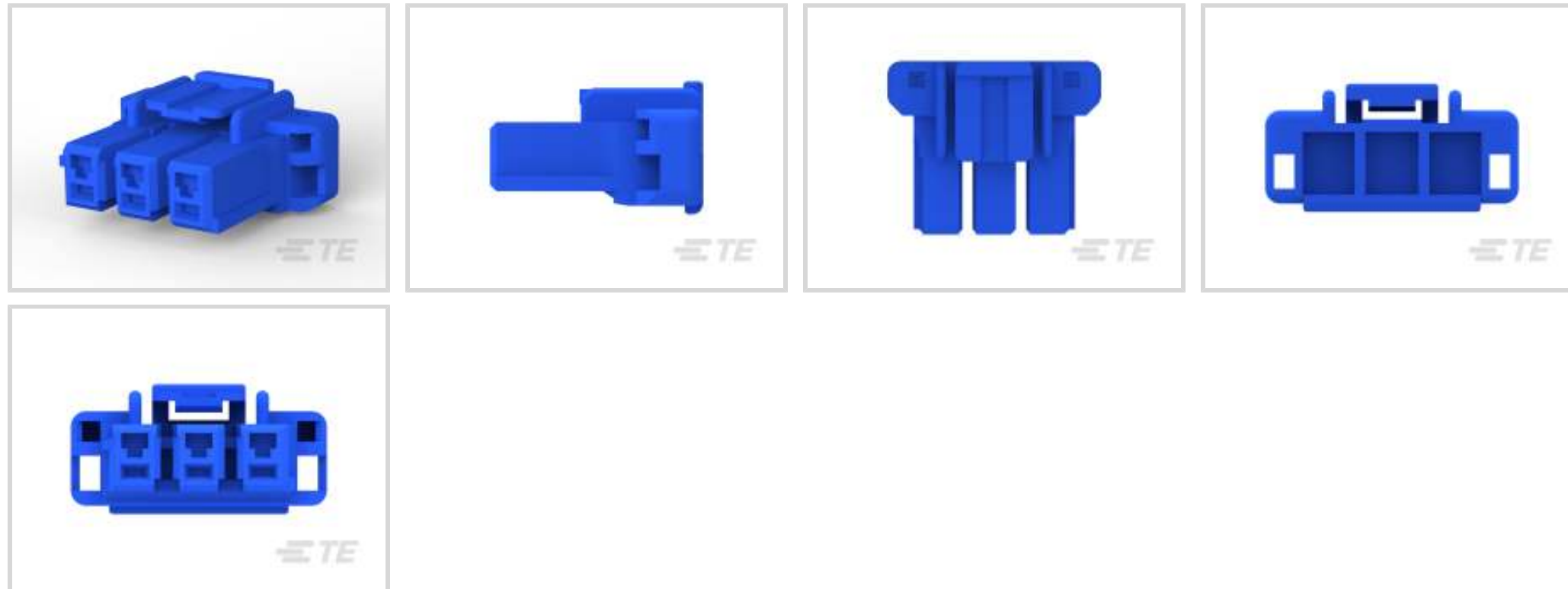

Rectangular Power Connector Type: **Housing**

Connector & Housing Type: **Plug**

Connector System: **Wire-to-Board**

Number of Positions: **3**

Centerline (Pitch): **5 mm [.197 in]**

[All STD Temp Power Key Plug \(34\)](#)

**Features**

**Product Type Features**

Rectangular Power Connector Type	Housing
Connector & Housing Type	Plug
Connector System	Wire-to-Board
Sealable	No
Connector & Contact Terminates To	Wire & Cable

**Configuration Features**

Number of Positions	3
Number of Power Positions	0
Number of Signal Positions	0
Number of Rows	1

**Electrical Characteristics**

Operating Voltage	300 VAC
-------------------	---------



### Contact Features

Contact Base Material	Copper Alloy
Contact Current Rating (Max)	10 A
Contact Retention Within Housing	Without
Contact Type	Receptacle

### Termination Features

Termination Method to Wire & Cable	Crimp
------------------------------------	-------

### Mechanical Attachment

Strain Relief	Without
Mating Alignment Type	Keyed
Mating Retention	With
Mating Alignment	With
Panel Mount Feature	Without
PCB Mount Retention	Without
Mating Retention Type	Latch
Connector Mounting Type	Cable Mount (Free-Hanging)

### Housing Features

Centerline (Pitch)	5 mm [.197 in]
Housing Color	Blue
Housing Material	Nylon 6/6 GF

### Dimensions

Connector Height	9.6 mm [.378 in]
Product Width	16.2 mm [.638 in]
Product Length	20 mm [.787 in]
Compatible Insulation Diameter Range	1.7 – 3.1 mm [.067 – .122 in]

### Usage Conditions

Operating Temperature Range	-30 – 105 °C [-22 – 221 °F]
-----------------------------	-----------------------------

### Operation/Application

Circuit Application	Power & Signal
---------------------	----------------

### Industry Standards

CSA Rating	LR 7189
UL Rating	Recognized



Agency/Standard	CSA, UL
Approved Standards	UL E28476
UL Flammability Rating	UL 94V-0
Glow Wire Rating	Standard Part - Not Glow Wire

### Packaging Features

Packaging Quantity	500
Packaging Method	Bag

### Product Compliance

[For compliance documentation, visit the product page on TE.com>](#)

EU RoHS Directive 2011/65/EU	Compliant
EU ELV Directive 2000/53/EC	Compliant
China RoHS 2 Directive MIIT Order No 32, 2016	No Restricted Materials Above Threshold
EU REACH Regulation (EC) No. 1907/2006	Current ECHA Candidate List: JUNE 2023 (235) Candidate List Declared Against: JUNE 2023 (235) Does not contain REACH SVHC
Halogen Content	Not Low Halogen - contains Br or Cl > 900 ppm.
Solder Process Capability	Not applicable for solder process capability

#### Product Compliance Disclaimer

This information is provided based on reasonable inquiry of our suppliers and represents our current actual knowledge based on the information they provided. This information is subject to change. The part numbers that TE has identified as EU RoHS compliant have a maximum concentration of 0.1% by weight in homogenous materials for lead, hexavalent chromium, mercury, PBB, PBDE, DBP, BBP, DEHP, DIBP, and 0.01% for cadmium, or qualify for an exemption to these limits as defined in the Annexes of Directive 2011/65/EU (RoHS2). Finished electrical and electronic equipment products will be CE marked as required by Directive 2011/65/EU. Components may not be CE marked. Additionally, the part numbers that TE has identified as EU ELV compliant have a maximum concentration of 0.1% by weight in homogenous materials for lead, hexavalent chromium, and mercury, and 0.01% for cadmium, or qualify for an exemption to these limits as defined in the Annexes of Directive 2000/53/EC (ELV). Regarding the REACH Regulation, the information TE provides on SVHC in articles for this part number is based on the latest European Chemicals Agency (ECHA) 'Guidance on requirements for substances in articles' posted at this URL: <https://echa.europa.eu/guidance-documents/guidance-on-reach>

### Compatible Parts

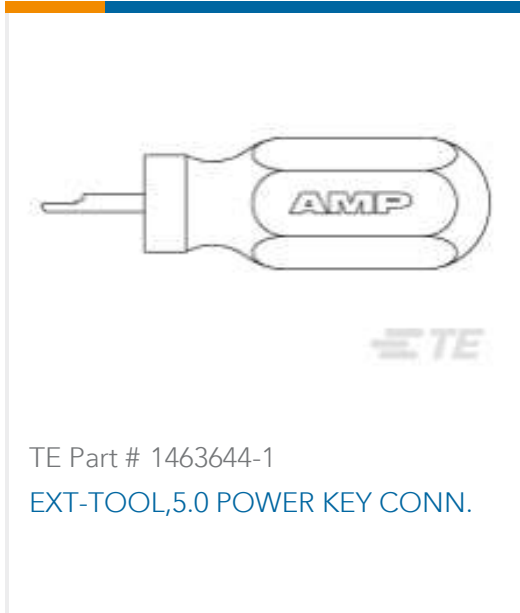

Also in the Series | **Power Key 5.0**

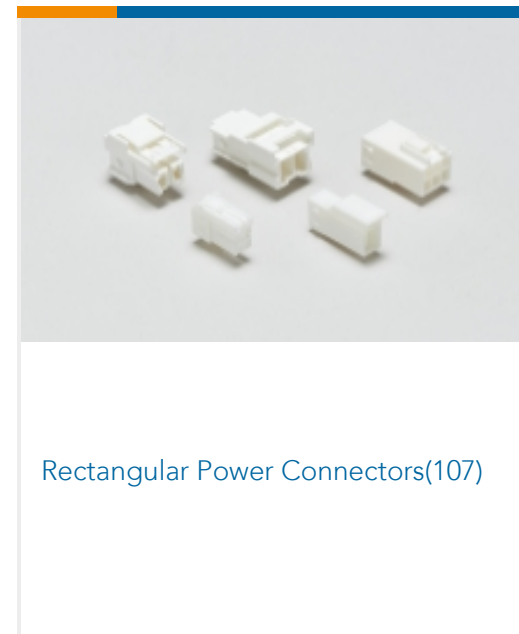
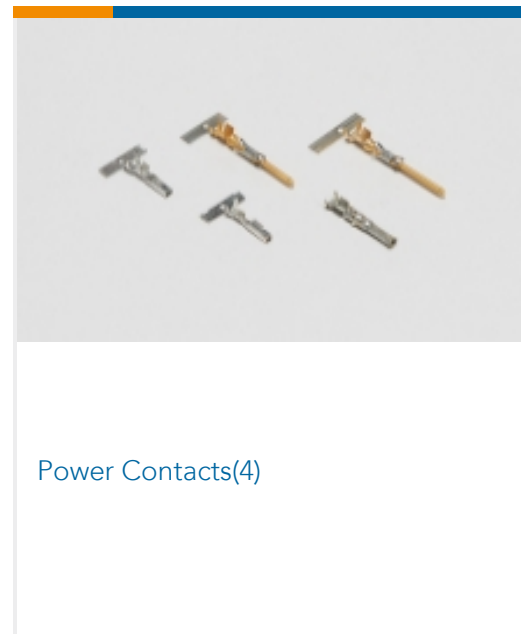
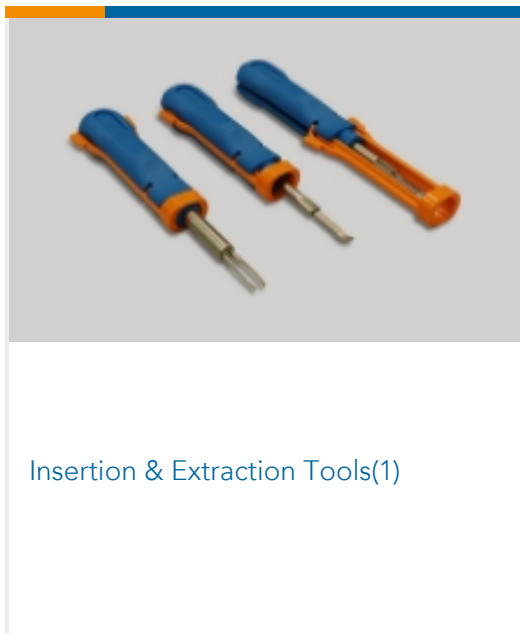

Customers Also Bought

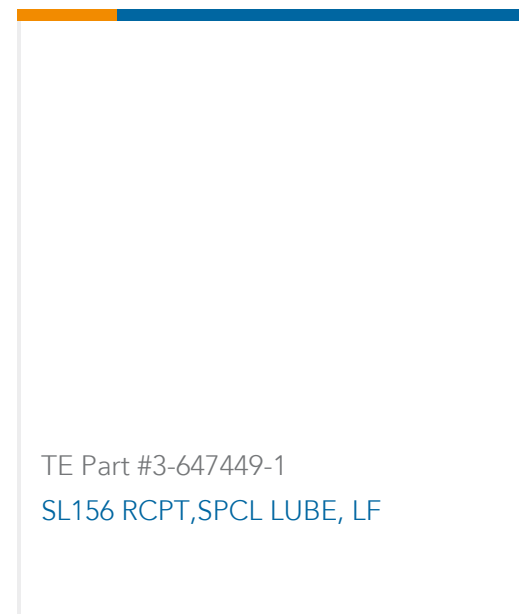
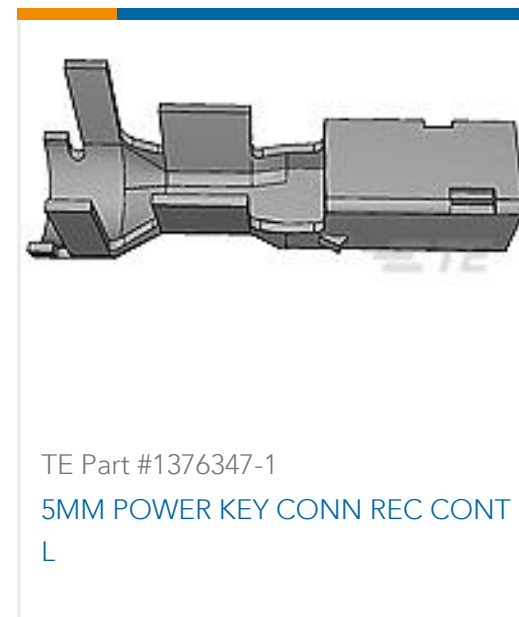
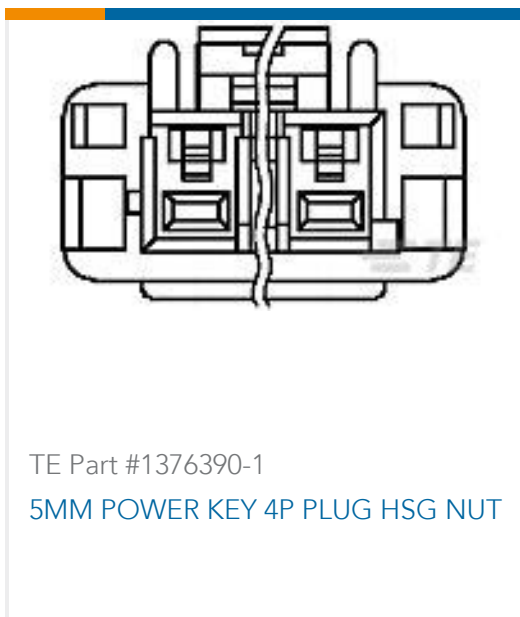



## Documents

### Product Drawings

#### 5MM POWER KEY 3P PLUG HSG BLUE

English

---

### CAD Files

#### Customer View Model

##### ENG\_CVM\_CVM\_2-1376389-3\_J.2d\_dxf.zip

English

#### 3D PDF

3D

#### Customer View Model

##### ENG\_CVM\_CVM\_2-1376389-3\_J.3d\_igs.zip

English

#### Customer View Model

##### ENG\_CVM\_CVM\_2-1376389-3\_J.3d\_stp.zip

English

By downloading the CAD file I accept and agree to the [Terms and Conditions](#) of use.

---

### Datasheets & Catalog Pages

#### SOFT\_SHELL\_PIN\_SOCKET\_CONNECTORS\_STANDARD\_DENSITY

English

#### 1-1773881-9 Power Key Connector Quick Reference Guide

English

---

### Product Specifications

#### 5.0 POWER KEY CONNECTOR

Japanese

#### Application Specification

Japanese

---

### Product Environmental Compliance

#### Product Compliance Document

English

#### Product Compliance Document

English

---

### Instruction Sheets

#### The extraction tool for 5MM Power Key Contact

English

#### Instruction Sheet (non U.S.)

English

---

### Agency Approvals

#### VDE Certificate

English

2-1376389-3

Rectangular Power Connectors, Housing, Plug, Wire-to-Board, 3 Position, 5 mm [.197 in] Centerline, Wire & Cable, UL 94V-0, Power Key 5.0

