

OBSOLETE - PART DISCONTINUED

Description

The AP3432 is a high efficiency step-down DC-DC voltage converter. The chip operation is optimized by peak-current mode architecture with built-in synchronous power MOSFET switchers.

The oscillator and timing capacitors are all built-in providing an internal switching frequency of 1.5MHz that allows the use of small surface mount inductors and capacitors for portable product implementations. Additional features including Soft Start (SS), Under Voltage Lock Out (UVLO), Thermal Shutdown Detection (TSD) and short circuit protection are integrated to provide reliable product applications.

The device is available in adjustable output voltage versions ranging from 0.8V to V_{IN} when input voltage range is from 2.7V to 5.5V, and is able to deliver up to 2.5A.

The AP3432 is available in DFN-3x3-6 package.

Features

- High Efficiency Buck Power Converter
- Low $R_{DS(ON)}$ Internal Switches: 100m Ω
- Output Current: 2.5A
- Adjustable Output Voltage from 0.8V to V_{IN}
- Wide Operating Voltage Range: 2.7V to 5.5V
- Built-in Power Switchers for Synchronous Rectification with High Efficiency
- Feedback Voltage Allows Output: 800mV
- 1.5MHz Switching Frequency
- Thermal Shutdown Protection
- Low Drop-out Operation at 100% Duty Cycle
- No Schottky Diode Required
- Input Over Voltage Protection
- **For automotive applications requiring specific change control (i.e. parts qualified to AEC-Q100/101/200, PPAP capable, and manufactured in IATF 16949 certified facilities), please [contact us](#) or your local Diodes representative. <https://www.diodes.com/quality/product-definitions/>**

Pin Assignments

(Top View)

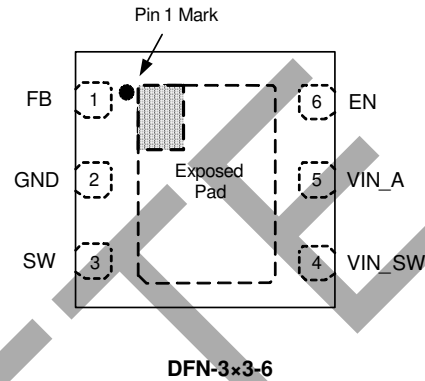

Applications

- LCD TV
- Set Top Box
- Post DC-DC Voltage Regulation
- PDA and Notebook Computer

Typical Applications Circuit (Note 1)

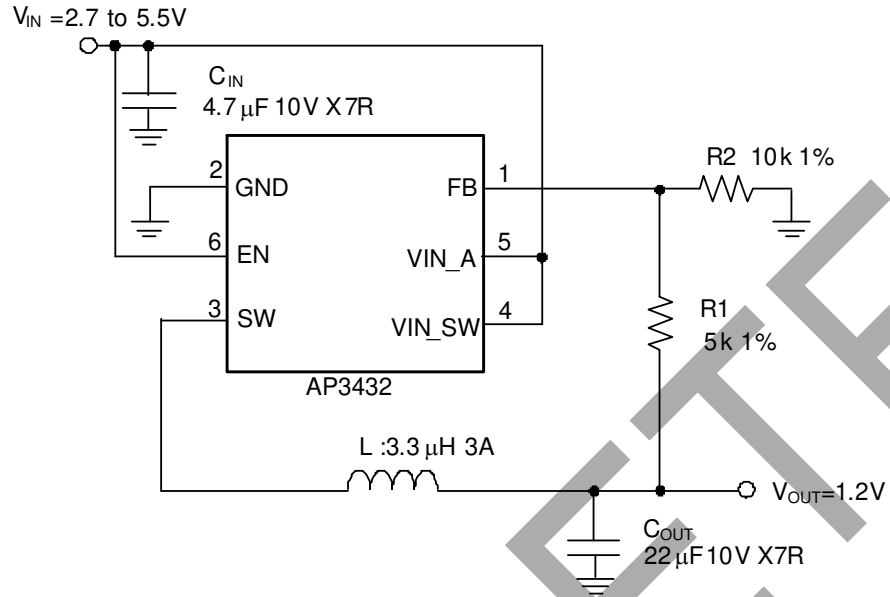

Note 1: $V_{OUT} = V_{FB} \times (1 + \frac{R_1}{R_2})$

V _{OUT} (V)	R ₁ (kΩ)	R ₂ (kΩ)	L (μH)
3.3	31.25	10	3.3
2.5	21.5	10	3.3
1.8	12.5	10	3.3
1.2	5	10	3.3
1.0	3	10	3.3

Table 1. Component Guide

Pin Descriptions

Pin Number	Pin Name	Function
1	FB	Output voltage feedback pin
2	GND	Ground pin
3	SW	Switch output pin
4	VIN_SW	Power supply input for the MOSFET switch
5	VIN_A	Supply input for the analog circuit
6	EN	Enable pin, active high

Functional Block Diagram

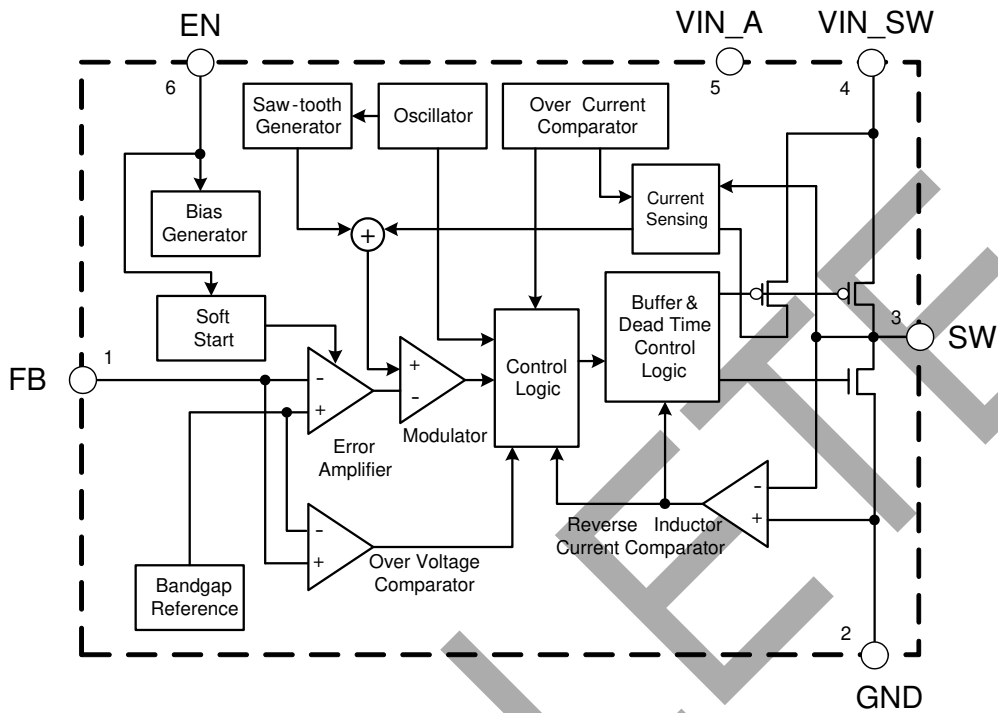

Absolute Maximum Ratings (Note 2)

Symbol	Parameter	Value	Unit
V_{IN_SW}	Supply Input Voltage (pin V_{IN_SW})	0 to 6.5	V
V_{IN_A}	Supply Input Voltage (pin V_{IN_A})	0 to 6.5	V
V_{SW}	SW Pin Switch Voltage	-0.3 to $V_{IN_SW}+0.3$	V
V_{EN}	Enable Voltage	-0.3 to $V_{IN_A}+0.3$	V
I_{SW}	SW Pin Switch Current	3.5	A
P_D	Power Dissipation (On PCB, $T_A=25^{\circ}C$)	2.49	W
θ_{JA}	Thermal Resistance (Junction to Ambient, Simulation)	40.11	$^{\circ}C/W$
T_J	Operating Junction Temperature	+150	$^{\circ}C$
T_{OP}	Operating Temperature	-40 to +85	$^{\circ}C$
T_{STG}	Storage Temperature	-55 to +150	$^{\circ}C$
V_{HBM}	ESD (Human Body Model)	2000	V
V_{MM}	ESD (Machine Model)	200	V

Note 2: Stresses greater than those listed under "Absolute Maximum Ratings" may cause permanent damage to the device. These are stress ratings only, and functional operation of the device at these or any other conditions beyond those indicated under "Recommended Operating Conditions" is not implied. Exposure to "Absolute Maximum Ratings" for extended periods may affect device reliability.

Recommended Operating Conditions

Symbol	Parameter	Min	Max	Unit
V_{IN}	Supply Input Voltage	2.7	5.5	V
T_J	Junction Temperature Range	-40	+125	°C
T_A	Ambient Temperature Range	-40	+80	°C

Electrical Characteristics ($V_{IN_SW}=V_{IN_A}=V_{EN}=5V$, $V_{OUT}=1.2V$, $V_{FB}=0.8V$, $L=3.3\mu H$, $C_{IN}=4.7\mu F$, $C_{OUT}=22\mu F$, $T_A=+25^\circ C$, unless otherwise specified.)

Symbol	Parameter	Conditions	Min	Typ	Max	Unit
V_{IN}	Input Voltage Range	—	2.7	—	5.5	V
I_{OFF}	Shutdown Current	$V_{EN}=0V$	—	—	1	μA
I_{ON}	Active Current	$V_{FB}=0.95V$	—	310	—	μA
V_{FB}	Regulated Feedback Voltage	For Adjustable Output Voltage	0.784	0.8	0.816	V
$\Delta V_{OUT}/V_{OUT}$	Regulated Output Voltage Accuracy	$V_{IN}=2.7V$ to $5.5V$, $I_{OUT}=10mA$ to $2.5A$	-3	—	3	%
I_{PK}	Peak Inductor Current	—	3.0	3.5	—	A
f_{OSC}	Oscillator Frequency	—	1.2	1.5	1.8	MHz
$R_{ON(P)}$	PMOSFET R_{ON}	$I_{SW}=0.75A$	—	100	—	m Ω
$R_{ON(N)}$	NMOSFET R_{ON}	$I_{SW}=0.75A$	—	100	—	m Ω
V_{EN_H}	EN High-level Input Voltage	—	1.5	—	—	V
V_{EN_L}	EN Low-level Input Voltage	—	—	—	0.4	V
I_{EN}	EN Input Current	—	—	—	1	μA
t_{SS}	Soft-start time	—	—	400	—	μS
D_{MAX}	Maximum Duty Cycle	—	100	—	—	%
V_{UVLO}	Under Voltage Lock Out	Rising	—	2.4	—	V
		Falling	—	2.3	—	
—	Hysteresis	Hysteresis	—	0.1	—	V
V_{OVP}	OVP Threshold	—	5.8	5.9	6.0	V
—	Hysteresis on OVP	—	300	400	500	mV
T_{SD}	Thermal Shutdown	Hysteresis=+30°C	—	+150	—	°C

Performance Characteristics

Efficiency vs. Output Current

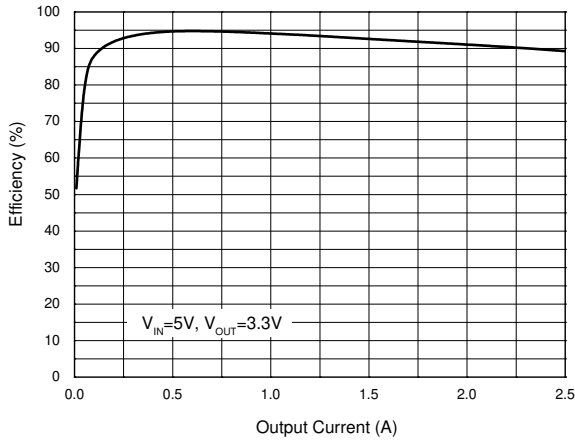

Efficiency vs. Output Current

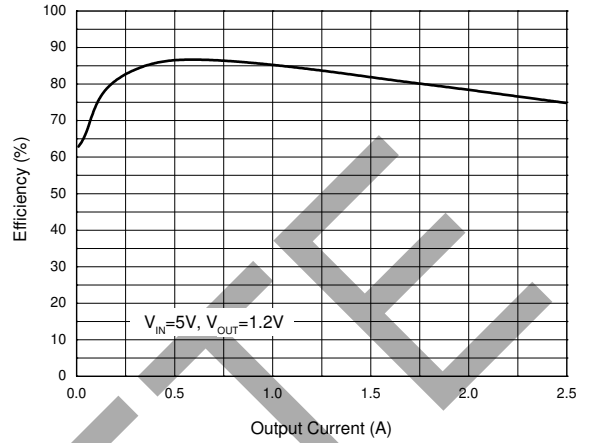

Efficiency vs. Output Current

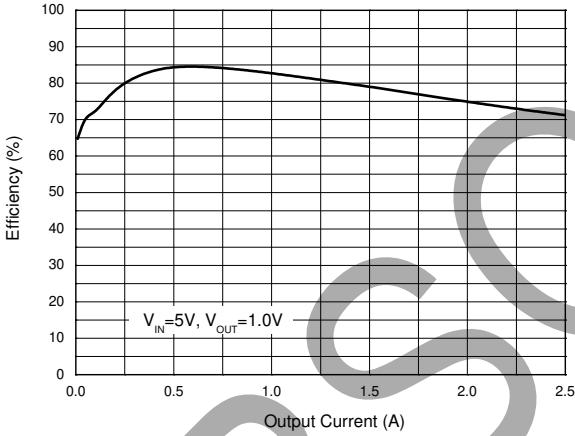

3.3V Load Regulation

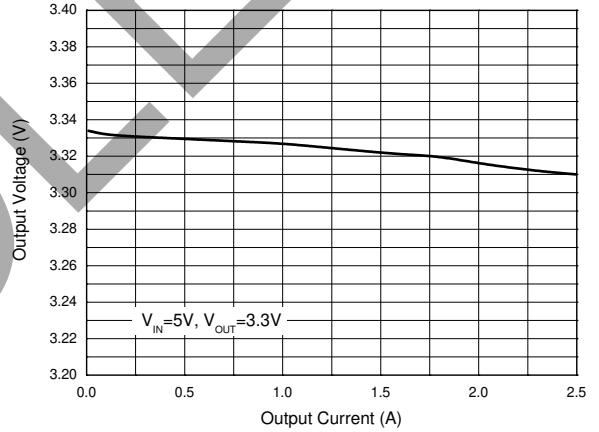

1.2V Load Regulation

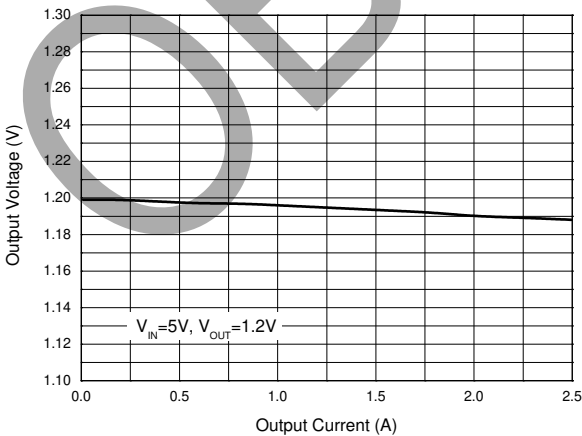

1.0V Load Regulation

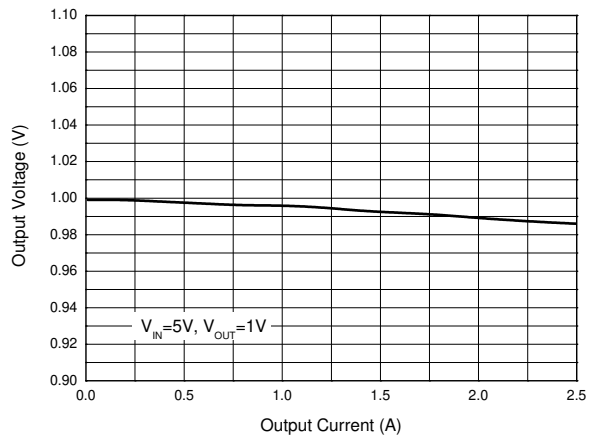

OBSOLETE - PART DISCONTINUED

Performance Characteristics (Cont.)

3.3V Line Regulation

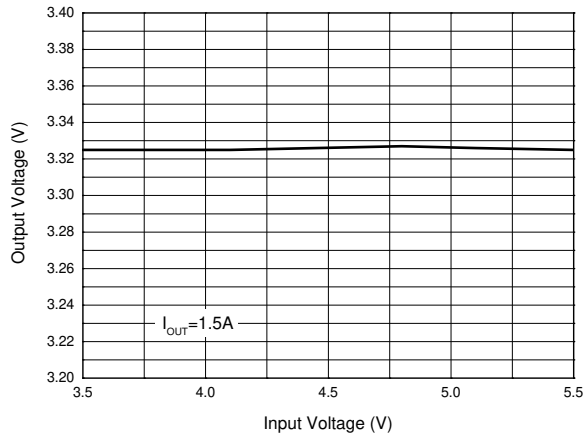

1.2V Line Regulation

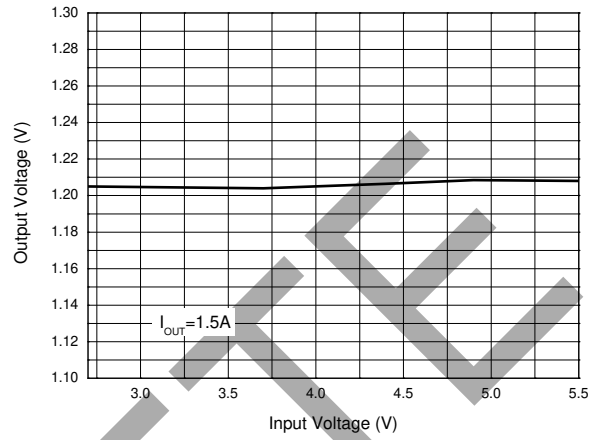

1.0V Line Regulation

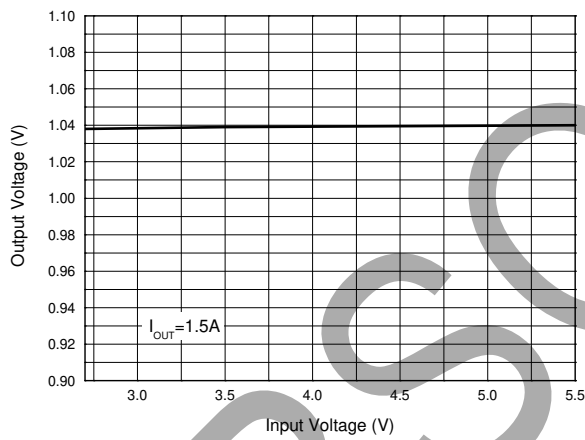

EN Threshold vs. Input Voltage

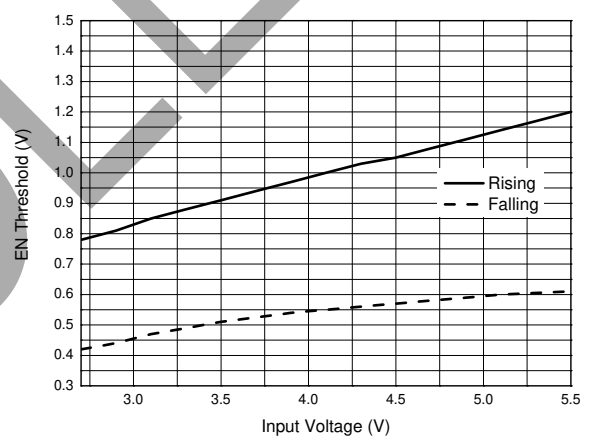

Reference Voltage vs. Output Current

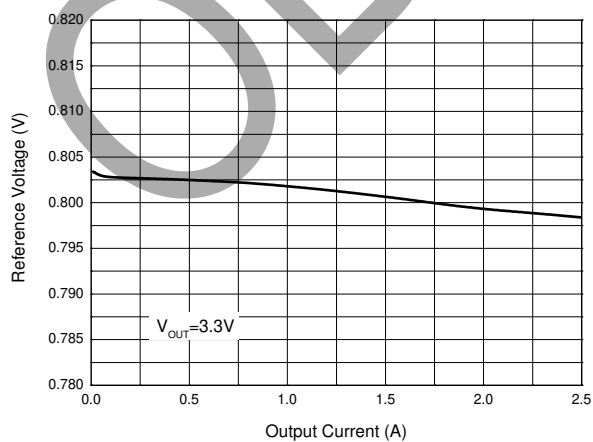

Temperature vs. Output Current

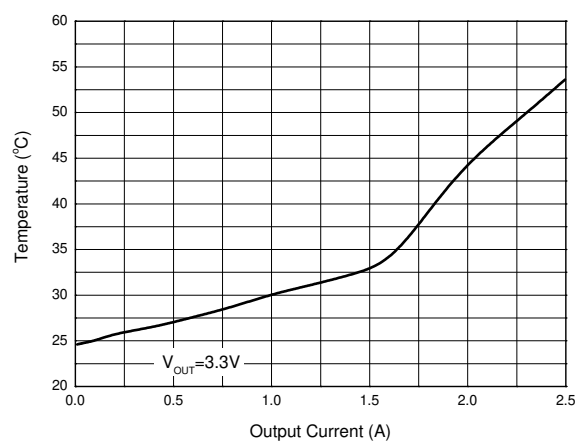

OBSOLETE - PART DISCONTINUED

Performance Characteristics (Cont.)

V_{OUT} Ripple
(V_{IN}=5V, V_{OUT}=3.3V, I_{OUT}=500mA)

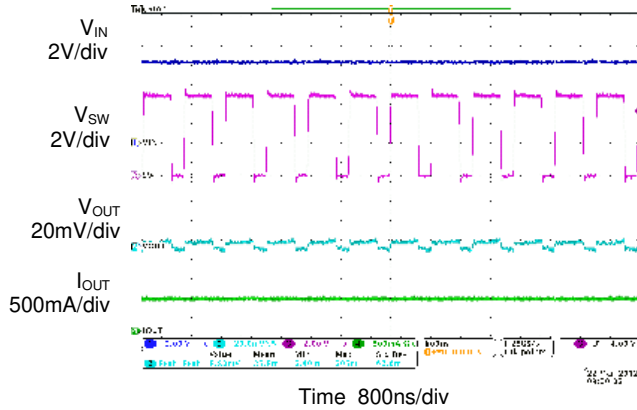

V_{OUT} Ripple
(V_{IN}=5V, V_{OUT}=3.3V, I_{OUT}=1000mA)

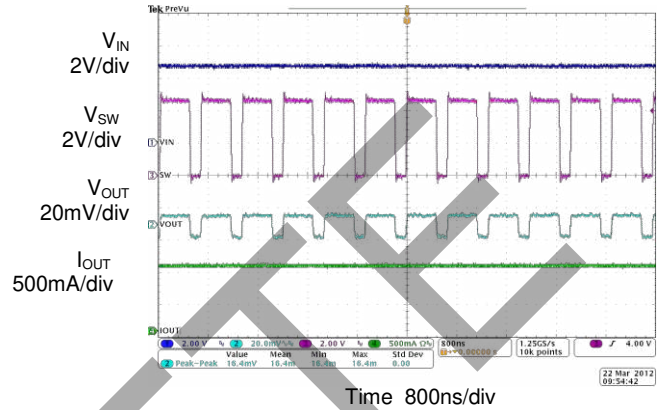

V_{OUT} Ripple
(I_{OUT}=2500mA)

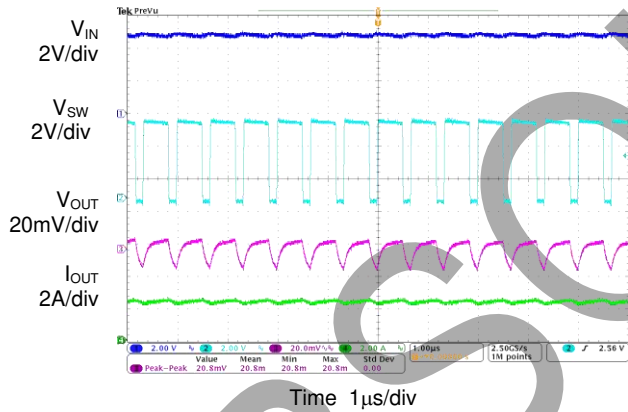

Dynamic Mode
(I_{OUT}=500mA to 2500mA)

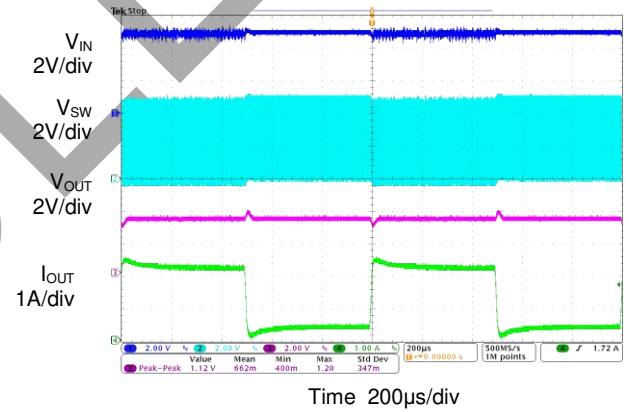

Dynamic Mode (Rising)

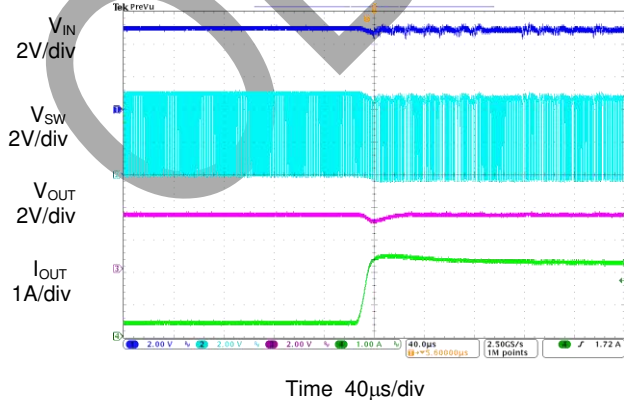

Dynamic Mode (Falling)

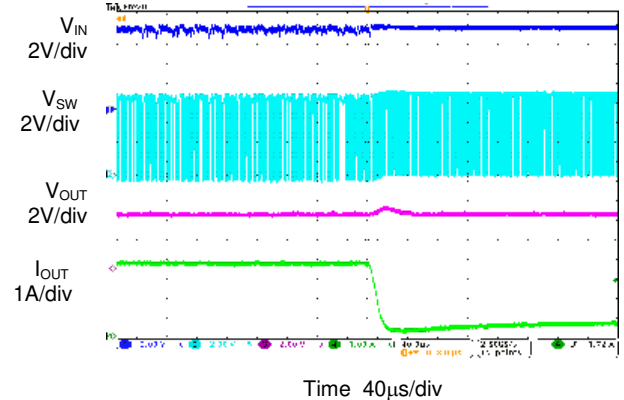

OBSOLETE - PART DISCONTINUED

Performance Characteristics (Cont.)

EN Pin L to H
($V_{IN}=5V$, $V_{OUT}=3.3V$, $I_{OUT}=100mA$)

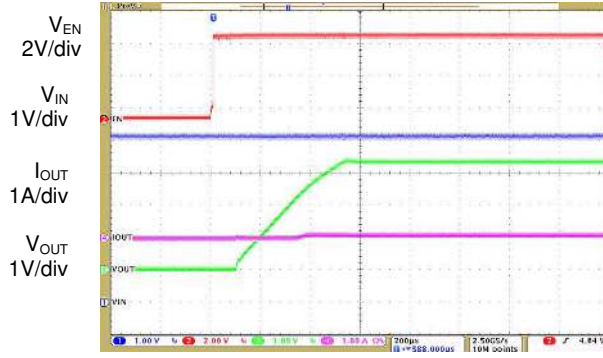

Time 200µs/div

EN Pin L to H
($V_{IN}=5V$, $V_{OUT}=3.3V$, $I_{OUT}=1000mA$)

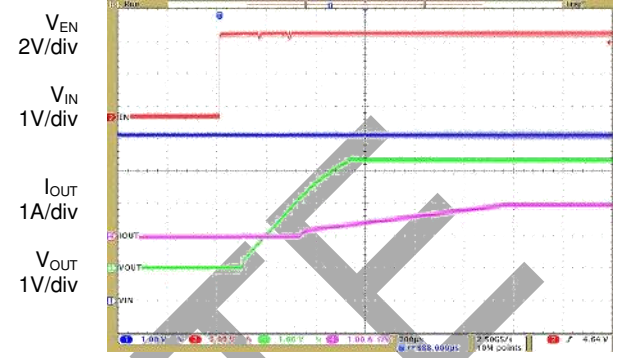

Time 200µs/div

EN Pin H to L
($V_{IN}=5V$, $V_{OUT}=3.3V$, $I_{OUT}=1A$)

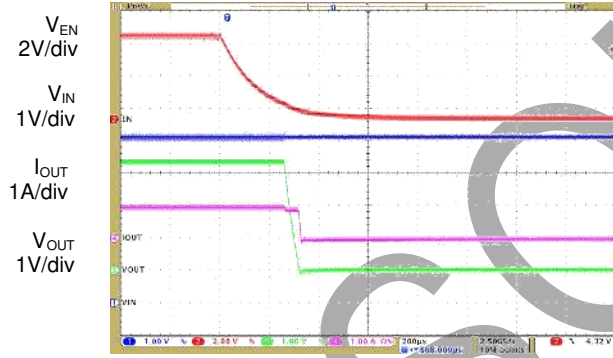

Time 200µs/div

Soft Start Function
($V_{IN}=5V$, $V_{OUT}=3.3V$, $I_{OUT}=0A$)

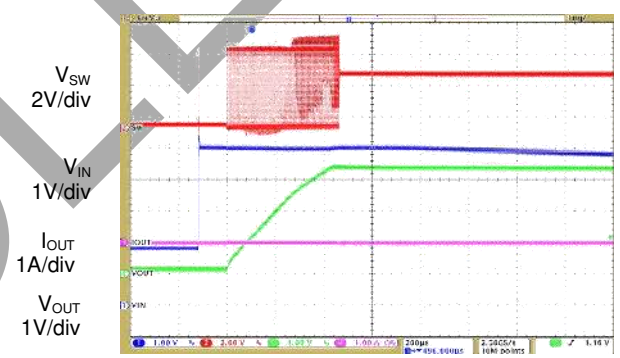

Time 200µs/div

Soft Start Function
($V_{IN}=5V$, $V_{OUT}=3.3V$, $I_{OUT}=1A$)

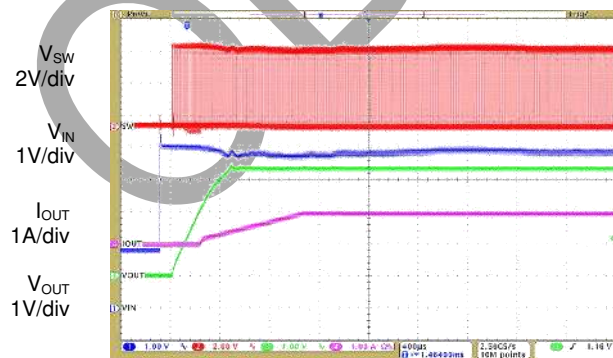

Time 400µs/div

OTP Function

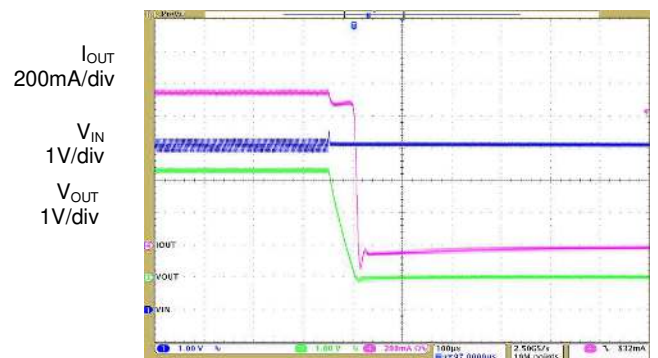

Time 100µs/div

OBSOLETE - PART DISCONTINUED

Performance Characteristics (Cont.)

OBSOLETE - PART DISCONTINUED

**OVP Function
($V_{IN}=5V$ to $6V$)**

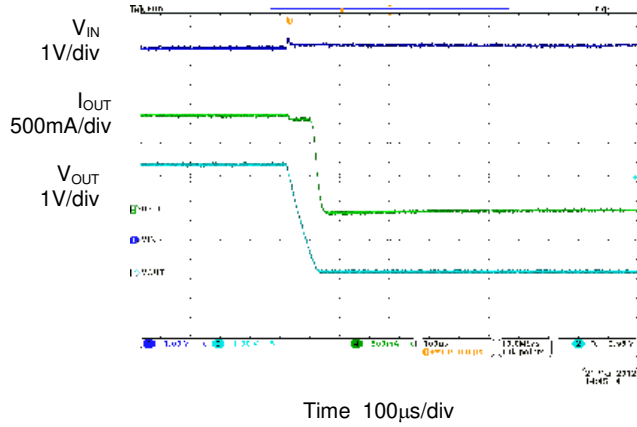

**Leave OVP Function
($V_{IN}=6V$ to $5V$)**

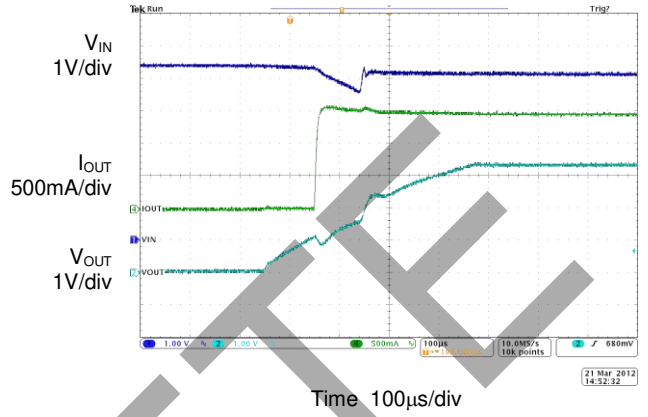

OBSOLETE

Application Information

5. Short Circuit Protection

When AP3432 output node is shorted to GND, as V_{FB} drops under 0.4V, the chip will enter soft-start to protect itself; when short circuit is removed, and V_{FB} rises over 0.4V, the chip will enter normal operation again. If AP3432 reaches OCP threshold while short circuit, it will enter soft-start cycle and last until the current drops under OCP threshold.

6. Efficiency Considerations

The efficiency of switching regulator is equal to the output power divided by the input power times 100%. It is usually useful to analyze the individual losses to determine what is limiting efficiency and which change could produce the largest improvement. Efficiency can be expressed as:

$$\text{Efficiency} = 100\% - L_1 - L_2 - \dots$$

Where L_1 , L_2 , etc. are the individual losses as a percentage of input power.

Although all dissipative elements in the regulator produce losses, two major sources usually account for most of the power losses: V_{IN} quiescent current and I^2R losses. The V_{IN} quiescent current loss dominates the efficiency loss at very light load currents and the I^2R loss dominates the efficiency loss at medium to heavy load currents.

6.1 The V_{IN} quiescent current loss comprises two parts: the DC bias current as given in the electrical characteristics and the internal MOSFET switch gate charge currents. The gate charge current results from switching the gate capacitance of the internal power MOSFET switches. Each cycle the gate is switched from high to low, then to high again, and the packet of charge, dQ moves from V_{IN} to ground. The resulting dQ/dt is the current out of V_{IN} that is typically larger than the internal DC bias current. In continuous mode,

$$I_{GATE} = f \times (Q_P + Q_N)$$

Where Q_P and Q_N are the gate charge of power PMOSFET and NMOSFET switches. Both the DC bias current and gate charge losses are proportional to

the V_{IN} and this effect will be more serious at higher input voltages.

6.2 I^2R losses are calculated from internal switch resistance, R_{SW} and external inductor resistance R_L . In continuous mode, the average output current flowing through the inductor is chopped between power PMOSFET switch and NMOSFET switch. Then, the series resistance looking into the SW pin is a function of both PMOSFET $R_{DS(ON)P}$ and NMOSFET $R_{DS(ON)N}$ resistance and the duty cycle (D):

$$R_{SW} = R_{DS(ON)P} \times D + R_{DS(ON)N} \times (1 - D)$$

Therefore, to obtain the I^2R losses, simply add R_{SW} to R_L and multiply the result by the square of the average output current.

Other losses including C_{IN} and C_{OUT} ESR dissipative losses and inductor core losses generally account for less than 2% of total additional loss.

7. Thermal Characteristics

In most applications, the part does not dissipate much heat due to its high efficiency. However, in some conditions when the part is operating in high ambient temperature with high $R_{DS(ON)}$ resistance and high duty cycles, such as in LDO mode, the heat dissipated may exceed the maximum junction temperature. To avoid the part from exceeding maximum junction temperature, the user should do some thermal analysis. The maximum power dissipation depends on the layout of PCB, the thermal resistance of IC package, the rate of surrounding airflow and the temperature difference between junction and ambient.

8. Input Over Voltage Protection

When the input voltage of AP3432 exceeds V_{OVP} , the IC would enter the mode of Input Over Voltage Protection. It will be shutdown and there will be no output voltage. As the input voltage goes down below 5.5V, the IC would leave input OVP mode and the output voltage will be recovered.

9. PC Board Layout Considerations

When laying out the printed circuit board, the following checklist should be used to optimize the

Application Information (Continued)

performance of AP3432.

1. The power traces, including the GND trace, the SW trace and the VIN trace should be kept direct, short and wide.
2. Put the input capacitor as close as possible to the VIN_SW, VIN_A and GND pins.

3. The FB pin should be connected directly to the feedback resistor divider.

4. Keep the switching node SW away from the sensitive FB pin and the node should be kept small area.

The following is an example of 2-layer PCB layout as shown in Figure 32 and Figure 33 for reference.

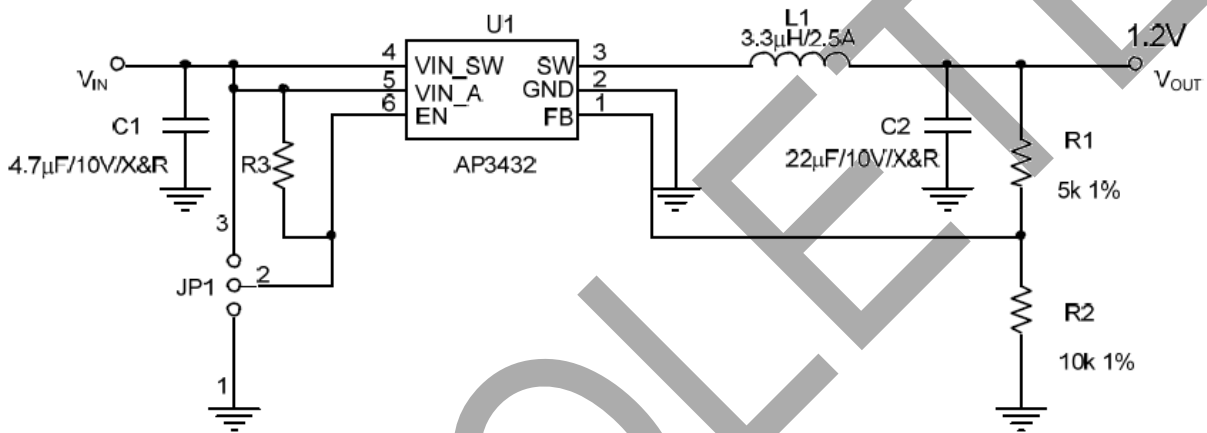

Figure 31. The Evaluation Board Schematic

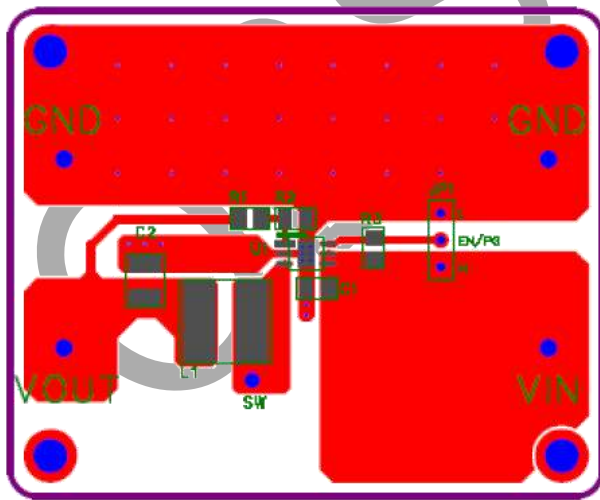

Figure 32. Top Layer for Demo Board

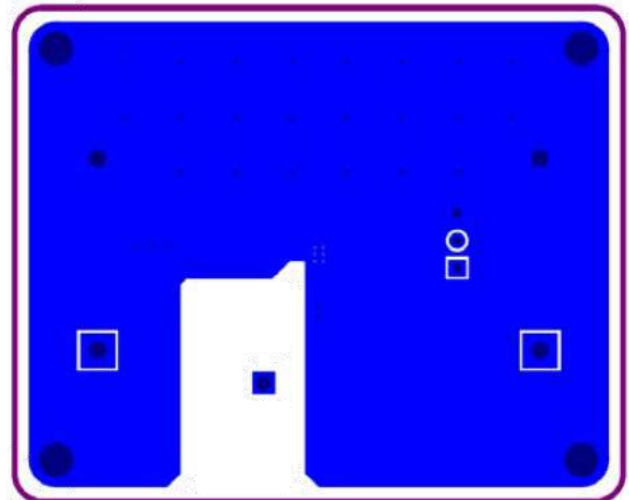
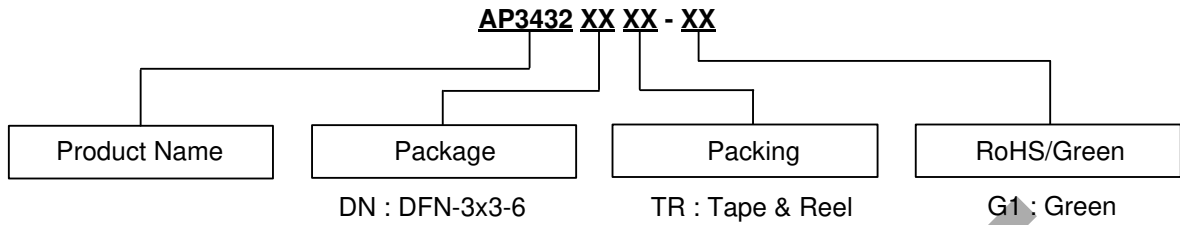

Figure 33. Bottom Layer for Demo Board

OBSOLETE - PART DISCONTINUED

Ordering Information



Package	Temperature Range	Part Number	Marking ID	Packing
DFN-3x3-6	-40 to +80°C	AP3432DNTR-G1	BQA	Tape & Reel

OBSOLETE - PART DISCONTINUED

OBSOLETE

IMPORTANT NOTICE

DIODES INCORPORATED MAKES NO WARRANTY OF ANY KIND, EXPRESS OR IMPLIED, WITH REGARDS TO THIS DOCUMENT, INCLUDING, BUT NOT LIMITED TO, THE IMPLIED WARRANTIES OF MERCHANTABILITY AND FITNESS FOR A PARTICULAR PURPOSE (AND THEIR EQUIVALENTS UNDER THE LAWS OF ANY JURISDICTION).

Diodes Incorporated and its subsidiaries reserve the right to make modifications, enhancements, improvements, corrections or other changes without further notice to this document and any product described herein. Diodes Incorporated does not assume any liability arising out of the application or use of this document or any product described herein; neither does Diodes Incorporated convey any license under its patent or trademark rights, nor the rights of others. Any Customer or user of this document or products described herein in such applications shall assume all risks of such use and will agree to hold Diodes Incorporated and all the companies whose products are represented on Diodes Incorporated website, harmless against all damages.

Diodes Incorporated does not warrant or accept any liability whatsoever in respect of any products purchased through unauthorized sales channel. Should Customers purchase or use Diodes Incorporated products for any unintended or unauthorized application, Customers shall indemnify and hold Diodes Incorporated and its representatives harmless against all claims, damages, expenses, and attorney fees arising out of, directly or indirectly, any claim of personal injury or death associated with such unintended or unauthorized application.

Products described herein may be covered by one or more United States, international or foreign patents pending. Product names and markings noted herein may also be covered by one or more United States, international or foreign trademarks.

This document is written in English but may be translated into multiple languages for reference. Only the English version of this document is the final and determinative format released by Diodes Incorporated.

LIFE SUPPORT

Diodes Incorporated products are specifically not authorized for use as critical components in life support devices or systems without the express written approval of the Chief Executive Officer of Diodes Incorporated. As used herein:

A. Life support devices or systems are devices or systems which:

1. are intended to implant into the body, or
2. support or sustain life and whose failure to perform when properly used in accordance with instructions for use provided in the labeling can be reasonably expected to result in significant injury to the user.

B. A critical component is any component in a life support device or system whose failure to perform can be reasonably expected to cause the failure of the life support device or to affect its safety or effectiveness.

Customers represent that they have all necessary expertise in the safety and regulatory ramifications of their life support devices or systems, and acknowledge and agree that they are solely responsible for all legal, regulatory and safety-related requirements concerning their products and any use of Diodes Incorporated products in such safety-critical, life support devices or systems, notwithstanding any devices- or systems-related information or support that may be provided by Diodes Incorporated. Further, Customers must fully indemnify Diodes Incorporated and its representatives against any damages arising out of the use of Diodes Incorporated products in such safety-critical, life support devices or systems.

Copyright © 2020, Diodes Incorporated

www.diodes.com