

## Compact, Applications-oriented Controllers with Built-in Pulse I/O for High Potential

- The compact, high-potential SYSMAC CJ1M PLCs provide built-in pulse I/O for high-precision performance
- Pulse I/O for two axes to achieve higher machine precision.



CJ1M-CPU21

## Features

### Two 100-kHz Pulse Outputs

- Use special instructions to easily implement various types of positioning, such as positioning with trapezoidal acceleration/deceleration, positioning with different acceleration/deceleration rates, and triangular control.
- Combine positioning instructions to handle many different applications, such as interrupt feeding and target position changes during positioning.
- Pulse startup is as fast as 46  $\mu$ s and is 70  $\mu$ s even for trapezoidal acceleration/deceleration.

### Two Pulse Inputs

- Two high-speed counters and four interrupt inputs are also built in. The high-speed counters operate at up to 100 kHz for single-phase and 50 kHz for differential-phase operation. These inputs enable controlling with high-speed response.

### Use the Rich Lineup of CJ1 Units

- Handle a wide range of applications with the rich lineup of CJ1 Units, including Ethernet and other Communications Units and Analog I/O Units.
- Easier maintenance is also possible using Memory Cards.

## Ordering Information

### International Standards

- The standards are abbreviated as follows: U: UL, U1: UL(Class I Division 2 Products for Hazardous Locations), C: CSA, UC: cULus, UC1: cULus (Class I Division 2 Products for Hazardous Locations), CU: cUL, N: NK, L: Lloyd, and CE: EC Directives.
- Contact your OMRON representative for further details and applicable conditions for these standards.





## CJ1M CPU Units (with Built-in I/O)







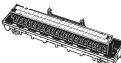

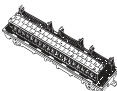

Product name		Specifications					Current consumption (A)		Model	Standards
		I/O capacity/ Mountable Units (Expansion Racks)	Program capacity	Data memory capacity	LD instruction execution time	Built-in I/O	5 V	24 V		
CJ1M CPU Units	 Built-in I/O (See note 2.)	640 points/20 Units (1 Expansion Racks max.)	20K steps	32K words (DM: 32K words, EM: None)	0.1 μs	10 inputs and 6 outputs, 2 counter inputs, 2 pulse outputs	0.64 (See note 1.)	–	<b>CJ1M-CPU23</b> (See note 3.)	UC1, N, L, CE
		320points/10 Units (No Expansion Rack)	10K steps				0.64 (See note 1.)	–	<b>CJ1M-CPU22</b> (See note 3.)	
		160 points/10 Units (No Expansion Rack)	5K steps				0.64 (See note 1.)	–	<b>CJ1M-CPU21</b> (See notes 2 and 3.)	

- Note: 1.** Current consumptions include current for a Programming Console. Add 0.15 A per Adapter when using NT-AL001 RS-232C/RS-232A Adapters. Add 0.04 A per Adapter when using CJ1W-CIF11 RS-422A Adapters.
- 2.** Some of the specifications for the low-end CJ1M CPU Units (CJ1M-CPU11(-ETN)/21) are different from the specifications for the other CJ1M CPU Units (CJ1M-CPU12(-ETN)/13(-ETN)/22/23), including the specifications for overhead time, pulse start time, the number of subroutines and jumps, the number of scheduled interrupt tasks, and the number of PWM outputs. For details, refer to the *SYSMAC CJ Series Programmable Controllers Operation Manual* (Cat. No. 393) and the *SYSMAC CJ Series Built-in I/O Operation Manual* (Cat. No. 395).
- 3.** The connector for built-in I/O in the CJ1M-CPU21/22/23 is not included. Purchase one of the connectors or connector cables in the following table separately.

## Connector Cables for Built-in I/O in CJ1M-CPU2□ CPU Units

The connector for built-in I/O in the CJ1M-CPU21/22/23 is not included.  
Purchase one of the connectors or connector cables in the following table separately.  
For details, refer to *Built-in I/O MIL Connector Wiring Methods*.

Product name	Specifications	Model	Standards
<b>Applicable Connector</b> 	MIL Flat Cable Connectors (Pressure-fitted Connectors)	<b>XG4M-4030-T</b>	–
<b>Connector-Terminal Block Conversion Units</b>	Slim type (M3 screw terminals, 40-pin) 	<b>XW2D-40G6</b>	–
	Through type (M3 screw terminals, 40-pin) 	<b>XW2B-40G4</b>	
	Through type (M3.5 screw terminals, 40-pin) 	<b>XW2B-40G5</b>	
<b>Cable for Connector-Terminal Block Conversion Unit</b> 		Cable length: 1 m	<b>XW2Z-100K</b>
		Cable length: 1.5 m	<b>XW2Z-150K</b>
		Cable length: 2 m	<b>XW2Z-200K</b>
		Cable length: 3 m	<b>XW2Z-300K</b>
		Cable length: 5 m	<b>XW2Z-500K</b>
<b>Servo Relay Units</b>	Servo Relay Unit for 1 axis 	<b>XW2B-20J6-8A</b>	–
	Servo Relay Unit for 2 axes 	<b>XW2B-40J6-9A</b>	

Product name	Specifications		Model	Standards
Cables for Servo Relay Units	OMNUC G Series	Cable for CJ1M CPU Unit 	Cable length: 0.5 m	XW2Z-050J-A33
			Cable length: 1 m	XW2Z-100J-A33
		Servo Driver Connecting Cables 	Cable length: 1 m	XW2Z-100J-B31
			Cable length: 2 m	XW2Z-200J-B31
	SMARTSTEP2	Cable for CJ1M CPU Unit 	Cable length: 0.5 m	XW2Z-050J-A33
			Cable length: 1 m	XW2Z-100J-A33
		Servo Driver Connecting Cables 	Cable length: 1 m	XW2Z-100J-B32
			Cable length: 2 m	XW2Z-200J-B32
	SMARTSTEP Junior	Cable for CJ1M CPU Unit 	Cable length: 1 m	XW2Z-100J-A26
		Servo Driver Connecting Cables 	Cable length: 1 m	XW2Z-100J-B17
			Cable length: 2 m	XW2Z-200J-B17
	SMARTSTEP A Series	Cable for CJ1M CPU Unit 	Cable length: 1 m	XW2Z-100J-A26
		Servo Driver Connecting Cables 	Cable length: 1 m	XW2Z-100J-B5
			Cable length: 2 m	XW2Z-200J-B5
OMNUC W Series	Cable for CJ1M CPU Unit 	Cable length: 0.5 m	XW2Z-050J-A27	
		Cable length: 1 m	XW2Z-100J-A27	
	Servo Driver Connecting Cables 	Cable length: 1 m	XW2Z-100J-B4	
		Cable length: 2 m	XW2Z-200J-B4	

## Accessories

The following accessories come with CPU Unit:

Item	Specification
<b>Battery</b>	CJ1W-BAT01
<b>End Cover</b>	CJ1W-TER01 (necessary to be mouned at the right end of CPU Rack)
<b>End Plate</b>	PFP-M (2 pcs)
<b>Serial Port (RS-232C) Connector</b>	Connector set for serial port connection (D-SUB 9-pin male connector)

# Specifications

## Common Specifications

Item	Specifications			
Control method	Stored program			
I/O control method	Cyclic scan and immediate processing are both possible.			
Programming	LD (Ladder), SFC (Sequential Function Chart), ST (Structured Text), Mnemonic			
CPU processing mode	Normal Mode or Peripheral Servicing Priority Mode			
Instruction length	1 to 7 steps per instruction			
Ladder instructions	Approx. 400 (3-digit function codes)			
Execution time	Basic instructions: 0.10 μs min. Special instructions: 0.15 μs min.			
Overhead time	<ul style="list-style-type: none"> <li>• CJ1M CPU Units (CPU22/23): 0.5 ms min.</li> <li>• CJ1M CPU Units (CPU21): 0.7 ms min.</li> </ul>			
Unit connection method	No Backplane: Units connected directly to each other.			
Mounting method	DIN Track (screw mounting not possible)			
Maximum number of connectable Units	Total of 20 Units in the System, including 10 Units on CPU Rack and 10 Units on one Expansion Rack.			
Maximum number of Expansion Racks	<ul style="list-style-type: none"> <li>• CJ1M CPU Units (CPU 13/23 only): 1 max. (An I/O Control Unit is required on the CPU Rack and an I/O Interface Unit is required on the Expansion Rack.)</li> <li>• CJ1M CPU Units (CPU11/12/21/22): Expansion is not possible.</li> </ul>			
Number of tasks	<p>288 (cyclic tasks: 32, interrupt tasks: 256) Interrupt tasks can be defined as cyclic tasks called "extra cyclic tasks." Including these, up to 288 cyclic tasks can be used.</p> <p><b>Note:</b> 1. Cyclic tasks are executed each cycle and are controlled with TKON(820) and TKOF(821) instructions. 2. The following 4 types of interrupt tasks are supported. Power OFF interrupt tasks: 1 max. Scheduled interrupt tasks: 2 max. I/O interrupt tasks: 32 max. External interrupt tasks: 256 max.</p>			
Interrupt types	<p>Scheduled Interrupts: Interrupts generated at a time scheduled by the CPU Unit's built-in timer. (See note. 1) I/O Interrupts: Interrupts from Interrupt Input Units. Power OFF Interrupts (See note 2.): Interrupts executed when the CPU Unit's power is turned OFF. External I/O Interrupts: Interrupts from the Special I/O Units or CPU Bus Units.</p> <p><b>Note:</b> 1. Scheduled interrupt time interval is 0.5 ms to 999.9 ms (in increments of 0.1 ms), 1 ms to 9,999 ms (in increments of 1 ms), or 10 ms to 99,990 ms (in increments of 10 ms) 2. Not supported when the CJ1W-PD022 Power Supply Unit is mounted.</p>			
Calling subroutines from more than one task	Supported (called "global subroutines").			
Function blocks (CPU Unit with unit version 3.0 or later only)	Languages in function block definitions: ladder programming, structured text			
CIO (Core I/O) Area	I/O Area	1,280: CIO 000000 to CIO 007915 (80 words from CIO 0000 to CIO 0079) The setting of the first word can be changed from the default (CIO 0000) so that CIO 0000 to CIO 0999 can be used. I/O bits are allocated to Basic I/O Units.	The CIO Area can be used as work bits if the bits are not used as shown here.	
	Link Area	3,200 (200 words): CIO 10000 to CIO 119915 (words CIO 1000 to CIO 1199) Link bits are used for data links and are allocated to Units in Controller Link Systems.		
	CPU Bus Unit Area	6,400 (400 words): CIO 150000 to CIO 189915 (words CIO 1500 to CIO 1899) CPU Bus Unit bits store the operating status of CPU Bus Units. (25 words per Unit, 16 Units max.)		
	Special I/O Unit Area	15,360 (960 words): CIO 200000 to CIO 295915 (words CIO 2000 to CIO 2959) Special I/O Unit bits are allocated to Special I/O Units. (10 words per Unit, 96 Units max.) <b>Note:</b> Special I/O Units are I/O Units that belong to a special group called "Special I/O Units." Example: CJ1W-AD081 Analog Input Unit		
	Serial PLC Link Area	1,440 (90 words): CIO 310000 to CIO 318915 (words CIO 3100 to CIO 3189)		
	DeviceNet Area	9,600 (600 words): CIO 320000 to CIO 379915 (words CIO 3200 to CIO 3799) DeviceNet bits are allocated to Slaves for DeviceNet Unit remote I/O communications when the Master function is used with fixed allocations.		
		Fixed allocation setting 1		Outputs: CIO 3200 to CIO 3263 Inputs: CIO 3300 to CIO 3363
Fixed allocation setting 2		Outputs: CIO 3400 to CIO 3463 Inputs: CIO 3500 to CIO 3563		
Fixed allocation setting 3		Outputs: CIO 3600 to CIO 3663 Inputs: CIO 3700 to CIO 3763		
The following words are allocated to the Master function even when the DeviceNet Unit is used as a Slave.				
Fixed allocation setting 1	Outputs: CIO 3370 (Slave to Master) Inputs: CIO 3270 (Master to Slave)			
Fixed allocation setting 2	Outputs: CIO 3570 (Slave to Master) Inputs: CIO 3470 (Master to Slave)			
Fixed allocation setting 3	Outputs: CIO 3770 (Slave to Master) Inputs: CIO 3670 (Master to Slave)			
Internal I/O Area	4,800 (300 words): CIO 120000 to CIO 149915 (words CIO 1200 to CIO 1499) 37,504 (2,344 words): CIO 380000 to CIO 614315 (words CIO 3800 to CIO 6143) These bits in the CIO Area are used as work bits in programming to control program execution. They cannot be used for external I/O.			

Item	Specifications
<b>Work Area</b>	8,192 bits (512 words): W00000 to W51115 (W000 to W511) Controls the programs only. (I/O from external I/O terminals is not possible.) <b>Note:</b> When using work bits in programming, use the bits in the Work Area first before using bits from other areas.
<b>Holding Area</b>	8,192 bits (512 words): H00000 to H51115 (H000 to H511) Holding bits are used to control the execution of the program, and maintain their ON/OFF status when the PLC is turned OFF or the operating mode is changed. <b>Note:</b> The Function Block Holding Area words are allocated from H512 to H1535. These words can be used only for the function block instance area (internally allocated variable area).
<b>Auxiliary Area</b>	Read only: 7,168 bits (448 words): A00000 to A44715 (words A000 to A447) Read/write: 8,192 bits (512 words): A44800 to A95915 (words A448 to A959) Auxiliary bits are allocated specific functions.
<b>Temporary Area</b>	16 bits (TR0 to TR15) Temporary bits are used to temporarily store the ON/OFF execution conditions at program branches.
<b>Timer Area</b>	4,096: T0000 to T4095 (used for timers only)
<b>Counter Area</b>	4,096: C0000 to C4095 (used for counters only)
<b>DM Area</b>	32 Kwords: D00000 to D32767 Used as a general-purpose data area for reading and writing data in word units (16 bits). Words in the DM Area maintain their status when the PLC is turned OFF or the operating mode is changed. Internal Special I/O Unit DM Area: D20000 to D29599 (100 words × 96 Units) Used to set parameters for Special I/O Units. CPU Bus Unit DM Area: D30000 to D31599 (100 words × 16 Units) Used to set parameters for CPU Bus Units.
<b>EM Area</b>	None
<b>Index Registers</b>	IR0 to IR15 Store PLC memory addresses for indirect addressing. Index registers can be used independently in each task. One register is 32 bits (2words). Setting to use index registers either independently in each task or to share them between tasks.
<b>Task Flag Area</b>	32 (TK0000 to TK0031) Task Flags are read-only flags that are ON when the corresponding cyclic task is executable and OFF when the corresponding task is not executable or in standby status.
<b>Trace Memory</b>	4,000 words (trace data: 31 bits, 6 words)
<b>File Memory</b>	Memory Cards: Compact flash memory cards can be used (MS-DOS format). OMRON Memory Cards can be used.

## Function Specifications

Item	Specifications	
<b>Constant cycle time</b>	1 to 32,000 ms (Unit: 1 ms)	
<b>Cycle time monitoring</b>	Possible (Unit stops operating if the cycle is too long): 10 to 40,000 ms (Unit: 10 ms)	
<b>I/O refreshing</b>	Cyclic refreshing, immediate refreshing, refreshing by IORF(097). IORF(097) refreshes I/O bits allocated to Basic I/O Units and Special I/O Units. The CPU BUS UNIT I/O REFRESH (DLNK(226)) instruction can be used to refresh bits allocated to CPU Bus Units in the CIO and DM Areas whenever required.	
<b>Timing of special refreshing for CPU Bus Units</b>	Data links for Controller Link Units and SYSMAC LINK Units, remote I/O for DeviceNet Units, and other special refreshing for CPU Bus Units is performed at the following times: I/O refresh period and when the CPU BUS UNIT I/O REFRESH (DLNK(226)) instruction is executed.	
<b>I/O memory holding when changing operating modes</b>	Depends on the ON/OFF status of the IOM Hold Bit in the Auxiliary Area.	
<b>Load OFF</b>	All outputs on Output Units can be turned OFF when the CPU Unit is operating in RUN, MONITOR, or PROGRAM mode.	
<b>Timer/Counter PV refresh method</b>	BCD or binary (CX-Programmer Ver. 3.0 or higher).	
<b>Input response time setting</b>	Time constants can be set for inputs from Basic I/O Units. The time constant can be increased to reduce the influence of noise and chattering or it can be decreased to detect shorter pulses on the inputs.	
<b>Mode setting at power-up</b>	Possible (By default, the CPU Unit will start in RUN mode if a Programming Console is not connected.)	
<b>Flash memory</b>	The user program and parameter area data (e.g., PLC Setup) are always backed up automatically in flash memory. (automatic backup and restore.) • CPU Units with unit version 3.0 or later only: When downloading projects from CX-Programmer Ver. 5.0 or higher, symbol table files (including CX-Programmer symbol names, I/O comments), comment files (CX-Programmer rung comments, other comments), and program index files (CX-Programmer section names, section comments, or program comments) are stored in comment memory within the flash memory.	
<b>Memory Card functions</b>	Automatically reading programs (autoboot) from the Memory Card when the power is turned ON.	Possible
	Program replacement during PLC operation	Possible
	Format in which data is stored in Memory Card	User program: Program file format PLC Setup and other parameters: Data file format I/O memory: Data file format (binary format), text format, or CSV format
	Functions for which Memory Card read/write is supported	User program instructions, Programming Devices (including CX-Programmer and Programming Consoles), Host Link computers, AR Area control bits, easy backup operation
<b>Filing</b>	Memory Card data and the EM (Extended Data Memory) Area can be handled as files.	
<b>Debugging</b>	Control set/reset, differential monitoring, data tracing (scheduled, each cycle, or when instruction is executed), instruction error tracing, storing location generating error when a program error occurs.	

Item	Specifications
<b>Online editing</b>	When the CPU Unit is in MONITOR or PROGRAM mode, multiple program sections ("circuits") of the user program can be edited together. This function is not supported for block programming areas. (With the CX-Programmer is used, multiple program sections of the user program can be edited together. When a Programming Console is used, the program can be edited in mnemonics only.)
<b>Program protection</b>	Overwrite protection: Set using DIP switch. Copy protection: Password set using CX-Programmer or Programming Consoles.
<b>Error check</b>	User-defined errors (i.e., user can define fatal errors and non-fatal errors) The FPD(269) instruction can be used to check the execution time and logic of each programming block. FAL and FALS instructions can be used with the CJ1M CPU Units to simulate errors.
<b>Error log</b>	Up to 20 errors are stored in the error log. Information includes the error code, error details, and the time the error occurred. A CJ1M CPU Unit can be set so that user-defined FAL errors are not stored in the error log.
<b>Serial communications</b>	Built-in peripheral port: Programming Device (including Programming Console) connections, Host Links, NT Links Built-in RS-232C port: Programming Device (excluding Programming Console) connections, Host Links, no-protocol communications, NT Links, Serial Gateway (Compoway/F master) Serial Communications Unit (sold separately): Protocol macros, Host Links, NT Links, Modbus-RTU slave, No-protocol, Serial Gateway (Compoway/F master, Modbus master)
<b>Clock</b>	Provided on all models. Accuracy:      Ambient temperature      Monthly error 55°C                              -3.5 min to +0.5 min 25°C                              -1.5 min to +1.5 min 0°C                                 -3 min to +1 min <b>Note:</b> Used to store the time when power is turned ON and when errors occur.
<b>Power OFF detection time</b>	AC Power Supply Unit: 10 to 25 ms (not fixed) DC Power Supply Unit PD025: 2 to 5 ms; PD022: 2 to 10 ms
<b>Power OFF detection delay time</b>	0 to 10 ms (user-defined, default: 0 ms) <b>Note:</b> Not supported when the CJ1W-PD022 Power Supply Unit is mounted.
<b>Memory protection</b>	Held Areas: Holding bits, contents of Data Memory and Extended Data Memory, and status of the counter Completion Flags and present values. <b>Note:</b> If the IOM Hold Bit in the Auxiliary Area is turned ON, and the PLC Setup is set to maintain the IOM Hold Bit status when power to the PLC is turned ON, the contents of the CIO Area, the Work Area, part of the Auxiliary Area, timer Completion Flag and PVs, Index Registers, and the Data Registers will be saved for up to 20 days.
<b>Sending commands to a Host Link computer</b>	FINS commands can be sent to a computer connected via the Host Link System by executing Network Communications Instructions from the PLC.
<b>Remote programming and monitoring</b>	Host Link communications can be used for remote programming and remote monitoring through a Controller Link, Ethernet, DeviceNet, or SYSMAC LINK network.
<b>Communicating across network levels</b>	Remote programming and monitoring from Support Software and FINS message communications can be performed across different network levels, even for different types of network. Pre-Ver. 2.0: Three levels Version 2.0 or later: Eight levels for Controller Link and Ethernet networks (See note.), three levels for other networks. <b>Note:</b> To communicate across eight levels, the CX-Integrator or the CX-Net in CX-Programmer version 4.0 or higher must be used to set the routing tables.
<b>Storing comments in CPU Unit</b>	I/O comments can be stored as symbol table files in the Memory Card, EM file memory, or comment memory (see note). <b>Note:</b> Comment memory is supported for CX-Programmer version 5.0 or higher and CS/CJ-series CPU Units with unit version 3.0 or later only.
<b>Program check</b>	Program checks are performed at the beginning of operation for items such as no END instruction and instruction errors. CX-Programmer can also be used to check programs.
<b>Control output signals</b>	RUN output: The internal contacts will turn ON (close) while the CPU Unit is operating (CJ1W-PA205R).
<b>Battery life</b>	Battery Set for CJ1M CPU Units: CJ1W-BAT01
<b>Self-diagnostics</b>	CPU errors (watchdog timer), I/O bus errors, memory errors, and battery errors.
<b>Other functions</b>	Storage of number of times power has been interrupted. (Stored in A514.)

## I/O Specifications of CJ1M CPU Units (CJ1M-CPU21/22/23)

- CJ1M-CPU2□ CPU Units have 10 built-in inputs and 6 built-in outputs.
- The 10 inputs can be used as general-purpose inputs, interrupt inputs, quick-response inputs, high-speed counters, or origin search origin input signals.
- The 6 outputs can be used as general-purpose outputs, pulse outputs, or origin search deviation counter reset outputs.

### Data Area Allocations for Built-in I/O

I/O Code		IN 0	IN 1	IN 2	IN 3	IN 4	IN 5	IN 6	IN 7	IN 8	IN 9	OUT 0	OUT 1	OUT 2	OUT 3	OUT 4	OUT 5	
Address		2960										2961						
Bit		0	1	2	3	4	5	6	7	8	9	0	1	2	3	4	5	
Inputs	General purpose inputs	General purpose input 0	General purpose input 1	General purpose input 2	General purpose input 3	General purpose input 4	General purpose input 5	General purpose input 6	General purpose input 7	General purpose input 8	General purpose input 9	–	–	–	–	–	–	
	Interrupt inputs	Interrupt input 0	Interrupt input 1	Interrupt input 2	Interrupt input 3	–	–	–	–	–	–	–	–	–	–	–	–	
	Quick response inputs	Quick response input 0	Quick response input 1	Quick response input 2	Quick response input 3	–	–	–	–	–	–	–	–	–	–	–	–	
	Highspeed counters	–	–	High-speed counter 1 (phase-Z/ reset)	High-speed counter 0 (phase-Z/ reset)	–	–	High-speed counter 1 (phase-A, increment, or count input)	High-speed counter 1 (phase-B, decrement, or direction input)	High-speed counter 0 (phase-A, increment, or count input)	High-speed counter 0 (phase-B, decrement, or direction input)	–	–	–	–	–	–	
Outputs	General-purpose outputs	–	–	–	–	–	–	–	–	–	–	General-purpose output 0	General-purpose output 1	General-purpose output 2	General-purpose output 3	General-purpose output 4	General-purpose output 5	
	Pulse outputs	CW/CCW outputs	–	–	–	–	–	–	–	–	–	–	Pulse output 0 (CW)	Pulse output 0 (CCW)	Pulse output 1 (CW)	Pulse output 1 (CCW)	–	–
		Pulse + direction outputs	–	–	–	–	–	–	–	–	–	–	Pulse output 0 (pulse)	Pulse output 1 (pulse)	Pulse output 0 (direction)	Pulse output 1 (direction)	–	–
		Variable duty ratio outputs	–	–	–	–	–	–	–	–	–	–	–	–	–	–	PWM (891) output 0	PWM (891) output 1
Origin search		Origin search 0 (Origin Input Signal)	Origin search 0 (Origin Proximity Input Signal)	Origin search 1 (Origin Input Signal)	Origin search 1 (Origin Proximity Input Signal)	Origin search 0 (Positioning Completed Signal)	Origin search 1 (Positioning Completed Signal)	–	–	–	–	–	–	–	–	Origin search 0 (Error Counter Reset Output)	Origin search 1 (Error Counter Reset Output)	

Note: CJ1M-CPU21 CPU Units have one PWM output only and do not have PWM output 1.

## Built-in Input Specifications

### Interrupt Inputs and Quick-response Inputs

Item	Specifications
No. of interrupt inputs/quick-response inputs	4 total
Input interrupts	<b>Direct (Input Interrupt) Mode</b> Execution of an interrupt task is started at the interrupt input's rising or falling edge. Interrupt numbers 140 to 143 are used (fixed). Response time from meeting input condition to start of interrupt task execution: 93 μs min.
	<b>High-speed Counter Mode</b> Rising or falling edges of the interrupt are counted using either an incrementing or decrementing counter, and an interrupt task is started when the input count reaches the set value. Interrupt numbers 140 to 143 are used (fixed). I/O response frequency: 1 kHz
Quick-response inputs	Signals that are shorter than the cycle time (30 μs min.) can be read and treated the same as signals that are one for more than one cycle time.

### High-speed Counter Inputs

Item	Specifications
Number of high-speed counters	2 (High-speed counters 0 and 1)
Pulse input mode (Selected in PLC Setup)	Differential phase inputs (phase-A, phase-B, and phase-Z input)      Up/down inputs (up inputs, down inputs, reset inputs)      Pulse + direction inputs (pulse inputs, direction inputs, reset inputs)      Increment inputs (increment inputs, reset inputs)
Response frequency	Line-driver inputs      50 kHz      100 kHz      100 kHz      100 kHz
	24-V DC inputs      30 kHz      60 kHz      60 kHz      60 kHz
Counting mode	Linear mode or Ring mode (Select in the PLC Setup.)

Item	Specifications	
Count value	Linear mode: 80000000 to 7FFFFFFF hex Ring mode: 00000000 to Ring SV (The Ring SV is set in the PLC Setup and the setting range is 00000001 to FFFFFFFF hex.)	
High-speed counter PV storage locations	High-speed counter 0: A271 (leftmost 4 digits) and A270 (rightmost 4 digits) High-speed counter 1: A273 (leftmost 4 digits) and A272 (rightmost 4 digits) Target value comparison interrupts or range comparison interrupts can be executed based on these PVs. <b>Note:</b> The PVs are refreshed in the overseeing processes at the beginning of each cycle. Use the PRV(881) instruction to read the most recent PVs.	
Control method	Target value comparison	Up to 48 target values and corresponding interrupt task numbers can be registered.
	Range comparison	Up to 8 ranges can be registered, with an upper limit, lower limit, and interrupt task number for each.
Counter reset method	Phase-Z + Software reset: Counter is reset when phase-Z input goes ON while Reset Bit is ON. Software reset: Counter is reset when Reset Bit goes ON. Reset Bits: High-speed Counter 0 Reset Bit is A53100, Counter 1 Reset Bit is A53101.	

## Built-in Output Specifications

### Position Control and Speed Control

Item	Specifications
Number of pulse outputs	2 (Pulse output 0 or 1)
Output frequency	1 Hz to 100 kHz (1-Hz units from 1 to 100 Hz, 10-Hz units from 100 Hz to 4 kHz, and 100-Hz units from 4 to 100 kHz)
Frequency acceleration and deceleration rates	Set in 1 Hz units for acceleration/deceleration rates from 1 Hz to 2 kHz (every 4 ms). The acceleration and deceleration rates can be set separately only with PLS2(887).
Changing SVs during instruction execution	The target frequency, acceleration/deceleration rate, and target position can be changed. Changes to the target frequency and acceleration/deceleration rate must be made at constant speed.
Pulse output method	CW/CCW inputs or Pulse + direction inputs
Number of output pulses	Relative coordinates: 00000000 to 7FFFFFFF hex (Each direction accelerating or decelerating: 2,147,483,647) Absolute coordinates: 80000000 to 7FFFFFFF hex (-2,147,483,648 to 2,147,483,647)
Instruction used for origin searches and returns	ORIGIN SEARCH (ORG(889)): Origin search and origin return operations according to set parameters
Instructions used for position and speed control	PULSE OUTPUT (PLS2(887)): Trapezoidal output control with separate acceleration and deceleration rate SET PULSES (PULS(886)): Setting the number of pulses for pulse output SPEED OUTPUT (SPED(885)): Pulse output without acceleration or deceleration (Number of pulses must be set in advance with PULS(886) for position control.) ACCELERATION CONTROL (ACC(888)): Changes frequency or pulse output with acceleration and deceleration MODE CONTROL (INI(880)): Stopping pulse output
Pulse output PV's storage location	The following Auxiliary Area words contain the pulse output PVs: Pulse output 0: A277 (leftmost 4 digits) and A276 (rightmost 4 digits) Pulse output 1: A279 (leftmost 4 digits) and A278 (rightmost 4 digits) The PVs are refreshed during regular I/O refreshing. PVs can be read to user-specified words with the PRV(881) instruction.

### Variable-duty Pulse Outputs (PWM)

Item	Specifications
Number of PWM outputs	CJ1M-CPU22/23: 2 (PWM output 0 or 1) CJ1M-CPU21: 1 (PWM output 0)
Duty ratio	0% to 100%, set in 0.1% units (See note.)
Frequency	0.1 Hz to 999.9 Hz, Set in 0.1 Hz units.
Instruction	PULSE WITH VARIABLE DUTY RATIO (PWM(891)): Sets duty ratio and outputs pulses.

**Note:** CJ1M CPU Unit Ver. 2.0 or later only. (0% to 100%, set in 1% units for Pre-Ver. 2.0 CPU Units.)

## Hardware Specifications

### Input Specifications

Item	Specifications			
Number of inputs	10 inputs			
Input method	24-V DC inputs or line driver (wiring changed to select)			
Input voltage specifications	24 V DC	Line driver		
	IN0 to IN5	IN6 to IN9	IN0 to IN5	IN6 to IN9
Input voltage	20.4 to 26.4 V DCV	RS-422A or RS-422 line driver (conforming to AM26LS31), Power supply voltage of 5 V ± 5%		
Input impedance	3.6 kΩ	4.0 kΩ	-	
Input current (typical)	6.2 mA	4.1 mA	13 mA	10 mA
Minimum ON voltage	17.4 V DC/3 mA min.		-	
Maximum OFF voltage	5.0 V DC/1 mA max.		-	
Response speed (for general-purpose inputs)	ON response time	Default setting: 8 ms max. (The input time constant can be set to 0 ms, 0.5 ms, 1 ms, 2 ms, 4 ms, 8 ms, 16 ms, or 32 ms in the PLC Setup.)		
	OFF response time	Default setting: 8 ms max. (The input time constant can be set to 0 ms, 0.5 ms, 1 ms, 2 ms, 4 ms, 8 ms, 16 ms, or 32 ms in the PLC Setup.)		



**Input Circuit Configuration**

Item	Specifications	
Input	IN0 to IN5	IN6 to IN9
Circuit configuration		

**General-purpose Output Specifications for Transistor Outputs (Sinking)**

Item	Specifications	
Output	OUT0 to OUT3	OUT4 to OUT5
Rated voltage	5 to 24 V DC	
Allowable voltage range	4.75 to 26.4 V DC	
Max. switching capacity	0.3 A/output; 1.8 A/Unit	
Number of circuits	6 outputs (6 outputs/common)	
Max. inrush current	3.0 A/output, 10 ms max.	
Leakage current	0.1 mA max.	
Residual voltage	0.6 V max.	
ON delay	0.1 mA max.	
OFF delay	0.1 mA max.	
Fuse	None	
External power supply	10.2 to 26.4 V DC 50 mA min.	

Circuit configuration		
-----------------------	--	--

**Pulse Output Specifications (OUT0 to OUT3)**

Item	Specifications
Max. switching capacity	30 mA, 4.75 to 26.4 V DC
Min. switching capacity	7 mA, 4.75 to 26.4 V DC
Max. output frequency	100 kHz
Output waveform	

## Unit Versions

Units	Models	Unit version
CJ1M CPU Units	CJ1M-CPU12/13 CJ1M-CPU22/23	Unit version 4.0
		Unit version 3.0
		Unit version 2.0
		Pre-Ver. 2.0
	CJ1M-CPU11/21	Unit version 4.0
		Unit version 3.0
		Unit version 2.0

## Function Support by Unit Version

### Functions Supported for Unit Version 4.0 or Later

CX-Programmer 7.0 or higher must be used to enable using the functions added for unit version 4.0. Additional functions are supported if CX-Programmer version 7.2 or higher is used.

#### CJ1M CPU Units

Function	CJ1M-CPU□□		
	Unit version 4.0 or later	Other unit versions	
Online editing of function blocks <b>Note:</b> This function cannot be used for simulations on the CX-Simulator.	OK	–	
Input-output variables in function blocks	OK	–	
Text strings in function blocks	OK	–	
New application instructions	Number-Text String Conversion Instructions: NUM4, NUM8, NUM16, STR4, STR8, and STR16	OK	–
	TEXT FILE WRITE (TWRIT)	OK	–
ST programming in task programs	OK with CX-Programmer version 7.2 or higher	–	
SFC programming in task programs	OK with CX-Programmer version 7.2 or higher	–	

User programs that contain functions supported only by CPU Units with unit version 4.0 or later cannot be used on CS/CJ-series CPU Units with unit version 3.0 or earlier. An error message will be displayed if an attempt is made to download programs containing unit version 4.0 functions to a CPU Unit with a unit version of 3.0 or earlier, and the download will not be possible.

If an object program file (.OBJ) using these functions is transferred to a CPU Unit with a unit version of 3.0 or earlier, a program error will occur when operation is started or when the unit version 4.0 function is executed, and CPU Unit operation will stop.

### Functions Supported for Unit Version 3.0 or Later

CX-Programmer 5.0 or higher must be used to enable using the functions added for unit version 3.0.

#### CJ1M CPU Units

Function	CJ1M-CPU□□		
	Unit version 3.0 or later	Other unit versions	
Function blocks	OK	–	
Serial Gateway (converting FINS commands to CompoWay/F commands at the built-in serial port)	OK	–	
Comment memory (in internal flash memory)	OK	–	
Expanded simple backup data	OK	–	
New application instructions	TXDU(256), RXDU(255) (support no-protocol communications with Serial Communications Units with unit version 1.2 or later)	OK	–
	Model conversion instructions: XFERC(565), DISTC(566), COLLC(567), MOVBC(568), BCNTC(621)	OK	–
	Special function block instructions: GETID(286)	OK	–
Additional instruction functions	PRV(881) and PRV2(883) instructions: Added high-frequency calculation methods for calculating pulse frequency. (CJ1M CPU Units only)	OK	–

User programs that contain functions supported only by CPU Units with unit version 3.0 or later cannot be used on CS/CJ-series CPU Units with unit version 2.0 or earlier. An error message will be displayed if an attempt is made to download programs containing unit version 3.0 functions to a CPU Unit with a unit version of 2.0 or earlier, and the download will not be possible.

If an object program file (.OBJ) using these functions is transferred to a CPU Unit with a unit version of 2.0 or earlier, a program error will occur when operation is started or when the unit version 3.0 function is executed, and CPU Unit operation will stop.

## Functions Supported for Unit Version 2.0 or Later

CX-Programmer 4.0 or higher must be used to enable using the functions added for unit version 2.0.

### CJ1-H/CJ1M CPU Units

Function	CJ1M CPU Units		
	CJ1M-CPU12/13/22/23		CJ1M-CPU11/21
	Unit version 2.0 or later	Other unit versions	Unit version 2.0 or later
Downloading and Uploading Individual Tasks	OK	–	OK
Improved Read Protection Using Passwords	OK	–	OK
Write Protection from FINS Commands Sent to CPU Units via Networks	OK	–	OK
Online Network Connections without I/O Tables	OK	– (Supported if I/O tables are automatically generated at startup.)	OK
Communications through a Maximum of 8 Network Levels	OK	–	OK
Connecting Online to PLCs via NS-series PTs	OK	OK from lot number 030201	OK
Setting First Slot Words	OK for up to 64 groups	OK for up to 8 groups	OK for up to 64 groups
Automatic Transfers at Power ON without a Parameter File	OK	–	OK
Automatic Detection of I/O Allocation Method for Automatic Transfer at Power ON	OK	–	OK
Operation Start/End Times	OK	–	OK
New Application Instructions	MILH, MILR, MILC	OK	–
	=DT, <>DT, <DT, <=DT, >DT, >=DT	OK	–
	BCMP2	OK	OK
	GRY	OK	OK from lot number 030201
	TPO	OK	–
	DSW, TKY, HKY, MTR, 7SEG	OK	–
	EXPLT, EGATR, ESATR, ECHRD, ECHWR	OK	–
	Reading/Writing CPU Bus Units with IORD/IOWR	OK	–
PRV2	OK, but only for CPU Units with built-in I/O	–	OK, but only for CPU Units with built-in I/O

User programs that contain functions supported only by CPU Units with unit version 2.0 or later cannot be used on CS/CJ-series Pre-Ver. 2.0 CPU Units. An error message will be displayed if an attempt is made to download programs containing unit version s.0 functions to a Pre-Ver. 2.0 CPU Unit, and the download will not be possible.

If an object program file (.OBJ) using these functions is transferred to a Pre-Ver. 2.0 CPU Unit, a program error will occur when operation is started or when the unit version 2.0 function is executed, and CPU Unit operation will stop.

## Unit Versions and Programming Devices

The following tables show the relationship between unit versions and CX-Programmer versions.

### Unit Versions and Programming Devices

CPU Unit	Functions (See note 1.)		CX-Programmer				Programming Console
			Ver. 3.3	Ver. 4.0	Ver. 5.0 Ver. 6.0	Ver. 7.0 or higher	
CS/CJ-series unit Ver. 4.0	Functions added for unit version 4.0	Using new functions	–	–	–	OK (See note 2 and 3.)	No restrictions
		Not using new functions	OK	OK	OK	OK	
CS/CJ-series unit Ver. 3.0	Functions added for unit version 3.0	Using new functions	–	–	OK	OK	
		Not using new functions	OK	OK	OK	OK	
CS/CJ-series unit Ver. 2.0	Functions added for unit version 2.0	Using new functions	–	OK	OK	OK	
		Not using new functions	OK	OK	OK	OK	

- Note: 1.** As shown above, there is no need to upgrade to CX-Programmer version as long as the functions added for unit versions are not used.
- 2.** CX-Programmer version 7.1 or higher is required to use the new functionality of CJ1-H-R CPU Units.  
When using CJ1-H-R CPU unit Ver.4.1, use CX-Programmer Ver.7.2 or later (Check the CX-Programmer version in "Version Information").
- 3.** CX-Programmer version 7.0 or higher is required to use the functional improvements made for unit version 4.0 of the CS/CJ-series CPU Units. With CX-Programmer version 7.2 or higher, you can use even more expanded functionality.

### Device Type Setting

The unit version does not affect the setting made for the device type on the CX-Programmer. Select the device type as shown in the following table regardless of the unit version of the CPU Unit.

Series	CPU Unit group	CPU Unit model	Device type setting on CX-Programmer Ver. 4.0 or higher
CJ Series	CJ1M CPU Units	CJ1M-CPU□□	CJ1M

## External Interface

A CJ-series CJ1M CPU Unit (with Built-in I/O) provides two communications ports (a peripheral port and an RS-232C port) and one built-in I/O port (40-pin MIL Connector).

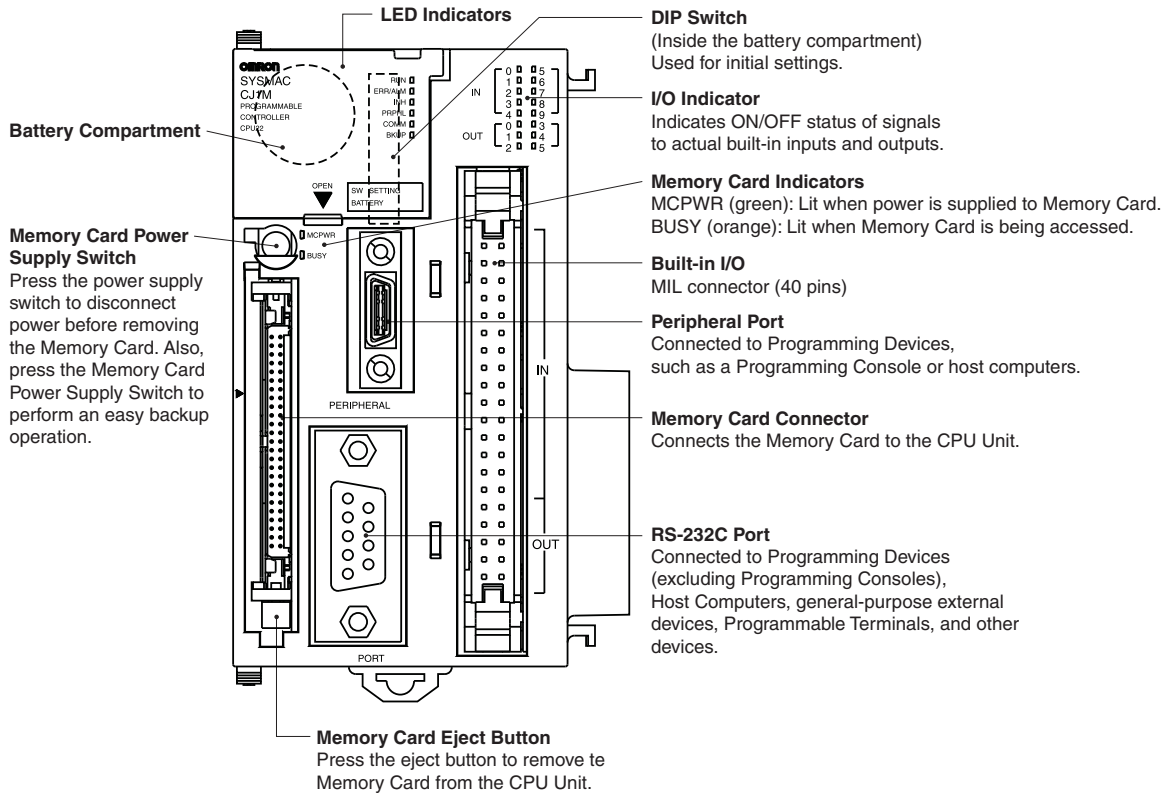

## Peripheral port

The peripheral port is used to connect a Programming Device (including a Programming Console) or a host computer. It can also be used as an RS-232C port by connecting a suitable cable, such as the CS1W-CN118 or CS1W-CN□26. The connector pin arrangement when using a connecting cable for an RS-232C port is shown below.

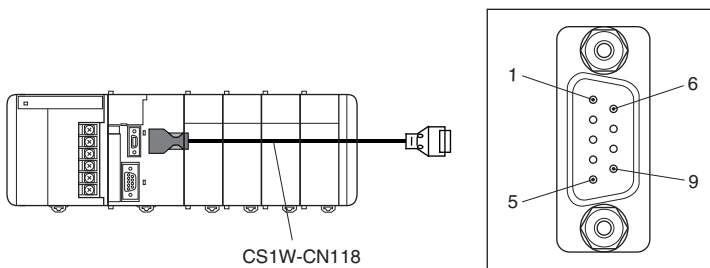

Pin No.	Signal	Name	Direction
1	-	-	-
2	SD (TXD)	Send data	Output
3	RD (RXD)	Receive data	Input
4	RS (RTS)	Request to send	Output
5	CS (CTS)	Clear to send	Input
6	Reserved	None	-
7	-	-	-
8	-	-	-
9	SG (0V)	Signal ground	-
Connector hood	FG	Protection earth	-

## RS-232C Port

Item	Specification
Communications method	Half duplex
Synchronization	Start-stop
Baud rate	0.3/0.6/1.2/2.4/4.8/9.6/19.2/38.4/57.6/115.2 kbps (See note.)
Transmission distance	15 m max.
Interface	EIA RS-232C
Protocol	Host Link, NT Link, 1:N, No-protocol, or Peripheral Bus

**Note:** Baud rates for the RS-232C are specified only up to 19.2 kbps. The CJ Series supports serial communications from 38.4 kbps to 115.2 kbps, but some computers cannot support these speeds. Lower the baud rate if necessary.

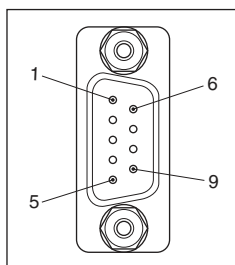

Pin No.	Signal	Name	Direction
1	FG	Protection earth	–
2	SD (TXD)	Send data	Output
3	RD (RXD)	Receive data	Input
4	RS (RTS)	Request to send	Output
5	CS (CTS)	Clear to send	Input
6	5V	Power supply	–
7	DR (DSR)	Data set ready	Input
8	ER (DTR)	Data terminal ready	Output
9	SG (0V)	Signal ground	–
Connector hood	FG	Protection earth	–

**Note:** Do not use the 5-V power from pin 6 of the RS-232C port for anything but the NT-AL001-E Link Adapter. Using this power supply for any other external device may damage the CPU Unit or the external device.

## Built-in I/O MIL connector (40 pins)

### Connector Pin Allocations

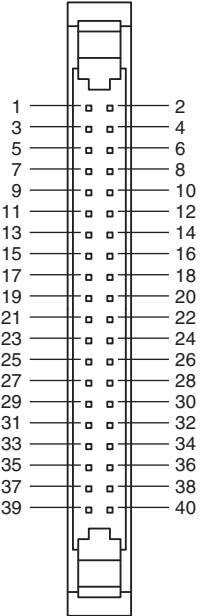
Pin layout	Code	Name	Input signal type	Pin No.	*1	Code	Name	Input signal type	Pin No.	*1
	IN0	<ul style="list-style-type: none"> <li>General-purpose input 0</li> <li>Interrupt input 0</li> <li>Quick-response input 0</li> <li>Origin search 0 (Origin Input Signal)</li> </ul>	24 V DC	1	A1	IN1	<ul style="list-style-type: none"> <li>General-purpose input 0</li> <li>Interrupt input 0</li> <li>Quick-response input 0</li> <li>Origin search 0 (Origin Proximity Input Signal)</li> </ul>	24 V DC	2	B1
			LD+	3	A2			LD+	4	B2
			0 V/LD-	5	A3			0 V/LD-	6	B3
	IN2	<ul style="list-style-type: none"> <li>General-purpose input 2</li> <li>Interrupt input 2</li> <li>Quick-response input 2</li> <li>High-speed counter 1 (Phase-Z/Reset input)</li> <li>Origin search 1 (Origin Input Signal)</li> </ul>	24 V DC	7	A4	IN3	<ul style="list-style-type: none"> <li>General-purpose input 3</li> <li>Interrupt input 3</li> <li>Quick-response input 3</li> <li>High-speed counter 0 (Phase-Z/Reset input)</li> <li>Origin search 1 (Origin Proximity Input Signal)</li> </ul>	24 V DC	8	B4
			LD+	9	A5			LD+	10	B5
			0 V/LD-	11	A6			0 V/LD-	12	B6
	IN4	<ul style="list-style-type: none"> <li>General-purpose input 4</li> <li>Origin search 0 (Positioning Completed Signal)</li> </ul>	24 V DC	13	A7	IN5	<ul style="list-style-type: none"> <li>General-purpose input 5</li> <li>Origin search 1 (Positioning Completed Signal)</li> </ul>	24 V DC	14	B7
			LD+	15	A8			LD+	16	B8
			0 V/LD-	17	A9			0 V/LD-	18	B9
	IN6	<ul style="list-style-type: none"> <li>General-purpose input 6</li> <li>High-speed counter 1 (Phase-A, Increment, or Count input)</li> </ul>	24 V DC	19	A10	IN7	<ul style="list-style-type: none"> <li>General-purpose input 7</li> <li>High-speed counter 1 (Phase-B, Decrement, or Direction input)</li> </ul>	24 V DC	20	B10
			LD+	21	A11			LD+	22	B11
			0 V/LD-	23	A12			0 V/LD-	24	B12
	IN8	<ul style="list-style-type: none"> <li>General-purpose input 8</li> <li>High-speed counter 0 (Phase-A, Increment, or Count input)</li> </ul>	24 V DC	25	A13	IN9	<ul style="list-style-type: none"> <li>General-purpose input 9</li> <li>High-speed counter 0 (Phase-B, Decrement, or Direction input)</li> </ul>	24 V DC	26	B13
			LD+	27	A14			LD+	28	B14
			0 V/LD-	29	A15			0 V/LD-	30	B15
	OUT0	General-purpose output 0	-	31	A16	OUT1	General-purpose output 1	-	32	B16
		<ul style="list-style-type: none"> <li>In CW/CCW mode: Pulse output 0 (CW)</li> <li>In Pulse + Direction mode: Pulse output 0 (pulse)</li> </ul>								
	OUT2	General-purpose output 2	-	33	A17	OUT3	General-purpose output 3	-	34	B17
		<ul style="list-style-type: none"> <li>In CW/CCW mode: Pulse output 1 (CW)</li> <li>In Pulse + Direction mode: Pulse output 0 (direction)</li> </ul>								
	OUT4	<ul style="list-style-type: none"> <li>General-purpose output 4</li> <li>Origin search 0 (Error Counter Reset Output)</li> <li>PWM(891) output 0</li> </ul>	-	35	A18	OUT5	<ul style="list-style-type: none"> <li>General-purpose output 5</li> <li>Origin search 1 (Error Counter Reset Output)</li> <li>PWM(891) output 1 *2</li> </ul>	-	36	B18
-	Power supply input (+V) for the output	-	37	A19	-	Not used	-	38	B19	
-	Output COM	-	39	A20	-	Output COM	-	40	B20	

\*1. These are the pins on the XW2D-□□G□ Terminal Block.

\*2. PWM(891) output 1 can be used only with the CJ1M-CPU22/CPU23.

## Built-in I/O MIL connector Wiring Methods

To connect to a Terminal Block, use an OMRON Cable preassembled with the special connector or attach the special connector (sold separately) to a cable yourself.

### Using User-made Cables with Connector

#### Connector Models

#### Compatible Connector Specifications

- MIL Flat Cable Connectors (40-pin Pressure-fitted Connectors)

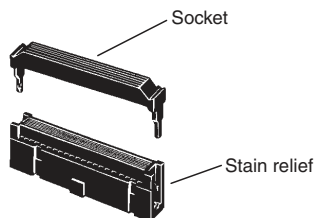

Name	OMRON model number	Daichi Electronics model number
Socket	XG4M-4030	FRC5-AO40-3TON
Stain Relief	XG4M-4004	-
Set model number	XG4M-4030-T	FRC5-AO40-3TOS
Recommended Flat Cable	XY3A-200□	-

- MIL Loose Wire Crimp Connectors (40-pin Pressure-fitted Connectors)

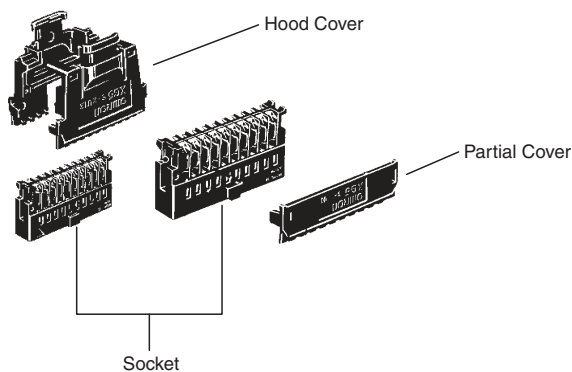

Name	OMRON model number	
Socket	AWG24	XG5M-4032-N
	AWG26 to AWG28	XG5M-4035-N
Spare Contacts (See note 1.)	AWG24	XG5W-0031-N
	AWG26 to AWG28	XG5W-0034-N
Hood Cover (See note 2.)	XG5S-4022	
Partial Cover (See note 2.) (2 required for each socket)	XG5S-2001	

- Note: 1.** Contacts are included with the Socket.  
**2.** Select either the Hood Cover or the Partial Cover.

#### Wiring

We recommend using a cable with wires sized between 28 and 24 AWG (0.2 to 0.08 mm<sup>2</sup>). Use a wire with an outer diameter of 1.61 mm max.

#### Compatible Terminal Blocks

Recommended Cable	Compatible Terminal Block	Number of pins	Size	Temperature (°C)
XW2Z-□□□K	XW2D-40G6	40	Small	0 to 55
	XW2B-40G5		Standard	-25 to 80
	XW2B-40G4			



## Using an OMRON Cable preassembled with the special connector

### Connection to Connector-Terminal Block Conversion Unit with Built-in I/O

CJ1M-CPU2□ (with Built-in I/O)

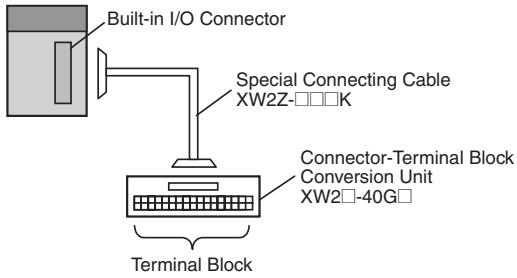

### Connection to Servo Driver with Built-in I/O

CJ1M-CPU2□ (with Built-in I/O)

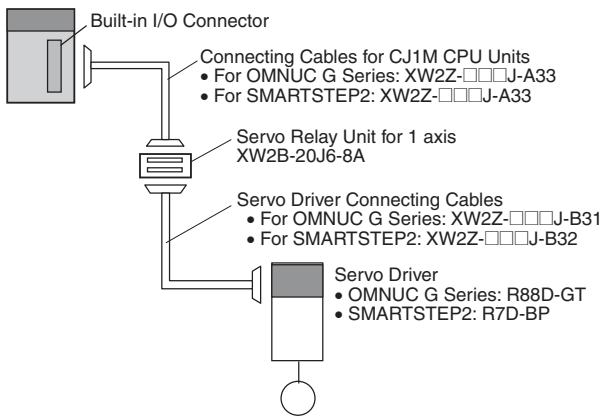

When two axes are used, two Connecting Cables are required at the Servo Driver for each Servo Relay Unit.

## Dimensions

(Unit : mm)

### CJ1M CPU Units (with Built-in I/O)

#### CJ1M-CPU21/22/23

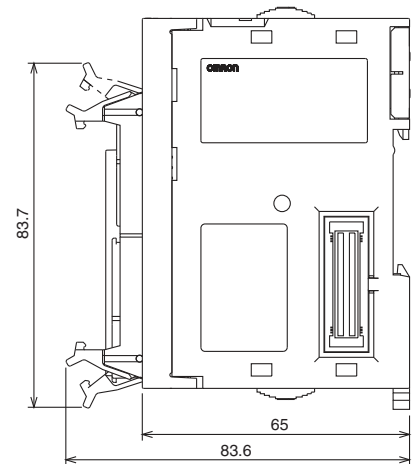
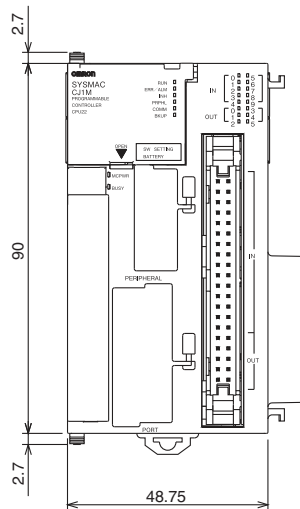

## About Manuals

Name	Cat. No.	Contents
SYSMAC CJ/NSJ Series CJ1H-CPU□□H-R, CJ1G-CPU□□, CJ1M-CPU□□, CJ1G-CPU□□P, CJ1G/H-CPU□□H Programmable Controllers Operation Manual	W393	Provides an outlines of and describes the design, installation, maintenance, and other basic operations for the CJ-series PLCs.
SYSMAC CS/CJ/NSJ Series CS1G/H-CPU□□-EV1, CS1G/H-CPU□□H, CS1D-CPU□□H, CS1D-CPU□□S, CJ1H-CPU□□H-R, CJ1G-CPU□□, CJ1M-CPU□□, CJ1G-CPU□□P, CJ1G/H-CPU□□H, NSJ□-□□□□(B)-G5D, NSJ□-□□□□(B)-M3D Programmable Controllers Programming Manual	W394	This manual describes programming and other methods to use the functions of the CS/CJ-series and NSJ-series PLCs.
SYSMAC CJ Series CJ1M-CPU21/22/23 Built-in I/O Operation Manual	W395	Describes the functions of the built-in I/O for CJ1M CPU Units.
SYSMAC CS/CJ/NSJ Series CS1G/H-CPU□□-EV1, CS1G/H-CPU□□H, CS1D-CPU□□H, CS1D-CPU□□S, CJ1H-CPU□□H-R, CJ1G-CPU□□, CJ1M-CPU□□, CJ1G-CPU□□P, CJ1G/H-CPU□□H, NSJ□-□□□□(B)-G5D, NSJ□-□□□□(B)-M3D Programmable Controllers Instructions Reference Manual	W340	Describes the ladder diagram programming instructions supported by CS/CJ-series and NSJ-series PLCs
SYSMAC CS/CJ Series CQM1H-PRO01-E, C200H-PRO27-E, CQM1-PRO01-E Programming Consoles Operation Manual	W341	Provides information on how to program and operate CS/CJ-series PLCs using a Programming Console.
SYSMAC CS/CJ/NSJ Series CS1G/H-CPU□□-EV1, CS1G/H-CPU□□H, CS1D-CPU□□H, CS1D-CPU□□S, CJ1G-CPU□□, CJ1M-CPU□□, CJ1G-CPU□□P, CJ1G/H-CPU□□H, CS1W-SCB□□-V1, CS1W-SCU□□-V1, CJ1W-SCU□□-V1, CP1H-X□□□□□-□, CP1H-XA□□□□□-□, CP1H-Y□□□□□-□, NSJ□-□□□□(B)-G5D, NSJ□-□□□□(B)-M3D Communications Commands Reference Manual	W342	Describes the C-series (Host Link) and FINS communications commands used with CS/CJ-series PLCs.
SYSMAC WS02-CX□□-V□ CX-Programmer Operation Manual	W446	Provides information on how to use the CX-Programmer for all functionality except for function blocks.
SYSMAC WS02-CX□□-V□ CX-Programmer Operation Manual Function Blocks (CS1G-CPU□□H, CS1H-CPU□□H, CJ1G-CPU□□H, CJ1H-CPU□□H, CJ1M-CPU□□, CP1H-X□□□□□-□, CP1H-XA□□□□□-□, CP1H-Y□□□□□-□ CPU Units)	W447	Describes the functionality unique to the CX-Programmer Ver. 7.0 and CP-series CPU Units or CS/CJ-series CPU Units with unit version 3.0 or later based on function blocks. Functionality that is the same as that of the CX-Programmer is described in W446 (enclosed).
CXONE-AL□□C-V□/CXONE-AL□□D-V□ CX-Integrator Operation Manual	W464	Describes operating procedures for the CX-Integrator Network Configuration Tool for CS-, CJ-, CP-, and NSJ-series Controllers.
CXONE-AL□□C-V□/AL□□D-V□ CX-One FA Integrated Tool Package Setup Manual	W463	Installation and overview of CX-One FA Integrated Tool Package.

## Read and Understand This Catalog

Please read and understand this catalog before purchasing the products. Please consult your OMRON representative if you have any questions or comments.

## Warranty and Limitations of Liability

### WARRANTY

OMRON's exclusive warranty is that the products are free from defects in materials and workmanship for a period of one year (or other period if specified) from date of sale by OMRON.

OMRON MAKES NO WARRANTY OR REPRESENTATION, EXPRESS OR IMPLIED, REGARDING NON-INFRINGEMENT, MERCHANTABILITY, OR FITNESS FOR PARTICULAR PURPOSE OF THE PRODUCTS. ANY BUYER OR USER ACKNOWLEDGES THAT THE BUYER OR USER ALONE HAS DETERMINED THAT THE PRODUCTS WILL SUITABLY MEET THE REQUIREMENTS OF THEIR INTENDED USE. OMRON DISCLAIMS ALL OTHER WARRANTIES, EXPRESS OR IMPLIED.

### LIMITATIONS OF LIABILITY

OMRON SHALL NOT BE RESPONSIBLE FOR SPECIAL, INDIRECT, OR CONSEQUENTIAL DAMAGES, LOSS OF PROFITS OR COMMERCIAL LOSS IN ANY WAY CONNECTED WITH THE PRODUCTS, WHETHER SUCH CLAIM IS BASED ON CONTRACT, WARRANTY, NEGLIGENCE, OR STRICT LIABILITY.

In no event shall the responsibility of OMRON for any act exceed the individual price of the product on which liability is asserted.

IN NO EVENT SHALL OMRON BE RESPONSIBLE FOR WARRANTY, REPAIR, OR OTHER CLAIMS REGARDING THE PRODUCTS UNLESS OMRON'S ANALYSIS CONFIRMS THAT THE PRODUCTS WERE PROPERLY HANDLED, STORED, INSTALLED, AND MAINTAINED AND NOT SUBJECT TO CONTAMINATION, ABUSE, MISUSE, OR INAPPROPRIATE MODIFICATION OR REPAIR.

## Application Considerations

### SUITABILITY FOR USE

OMRON shall not be responsible for conformity with any standards, codes, or regulations that apply to the combination of products in the customer's application or use of the products.

At the customer's request, OMRON will provide applicable third party certification documents identifying ratings and limitations of use that apply to the products. This information by itself is not sufficient for a complete determination of the suitability of the products in combination with the end product, machine, system, or other application or use.

The following are some examples of applications for which particular attention must be given. This is not intended to be an exhaustive list of all possible uses of the products, nor is it intended to imply that the uses listed may be suitable for the products:

- Outdoor use, uses involving potential chemical contamination or electrical interference, or conditions or uses not described in this catalog.
- Nuclear energy control systems, combustion systems, railroad systems, aviation systems, medical equipment, amusement machines, vehicles, safety equipment, and installations subject to separate industry or government regulations.
- Systems, machines, and equipment that could present a risk to life or property.

Please know and observe all prohibitions of use applicable to the products.

NEVER USE THE PRODUCTS FOR AN APPLICATION INVOLVING SERIOUS RISK TO LIFE OR PROPERTY WITHOUT ENSURING THAT THE SYSTEM AS A WHOLE HAS BEEN DESIGNED TO ADDRESS THE RISKS, AND THAT THE OMRON PRODUCTS ARE PROPERLY RATED AND INSTALLED FOR THE INTENDED USE WITHIN THE OVERALL EQUIPMENT OR SYSTEM.

### PROGRAMMABLE PRODUCTS

OMRON shall not be responsible for the user's programming of a programmable product, or any consequence thereof.

## Disclaimers

### CHANGE IN SPECIFICATIONS

Product specifications and accessories may be changed at any time based on improvements and other reasons.

It is our practice to change model numbers when published ratings or features are changed, or when significant construction changes are made. However, some specifications of the products may be changed without any notice. When in doubt, special model numbers may be assigned to fix or establish key specifications for your application on your request. Please consult with your OMRON representative at any time to confirm actual specifications of purchased products.

### DIMENSIONS AND WEIGHTS

Dimensions and weights are nominal and are not to be used for manufacturing purposes, even when tolerances are shown.

### PERFORMANCE DATA

Performance data given in this catalog is provided as a guide for the user in determining suitability and does not constitute a warranty. It may represent the result of OMRON's test conditions, and the users must correlate it to actual application requirements. Actual performance is subject to the OMRON Warranty and Limitations of Liability.

### ERRORS AND OMISSIONS

The information in this document has been carefully checked and is believed to be accurate; however, no responsibility is assumed for clerical, typographical, or proofreading errors, or omissions.

2012.4

In the interest of product improvement, specifications are subject to change without notice.

**OMRON Corporation**  
Industrial Automation Company

<http://www.ia.omron.com/>

(c)Copyright OMRON Corporation 2012 All Right Reserved.