

## Power MOSFET

### PRODUCT SUMMARY

$V_{DS}$ (V)	500	
$R_{DS(on)}$ ( $\Omega$ )	$V_{GS} = 10$ V	0.125
$Q_g$ (Max.) (nC)	230	
$Q_{gs}$ (nC)	65	
$Q_{gd}$ (nC)	110	
Configuration	Single	

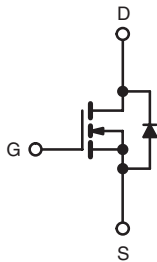

N-Channel MOSFET



### FEATURES

- Super Fast Body Diode Eliminates the Need for External Diodes in ZVS Applications
- Lower Gate Charge Results in Simpler Drive Requirements
- Enhanced  $dV/dt$  Capabilities Offer Improved Ruggedness
- Higher Gate Voltage Threshold Offers Improved Noise Immunity
- Lead (Pb)-free Available



Available

**RoHS\***  
COMPLIANT

### APPLICATIONS

- Zero Voltage Switching SMPS
- Telecom and Server Power Supplies
- Uninterruptible Power Supplies
- Motor Control Applications

### ORDERING INFORMATION

Package	SUPER-247™
Lead (Pb)-free	IRFPS35N50LPbF
	SiHFPS35N50L-E3
SnPb	IRFPS35N50L
	SiHFPS35N50L

### ABSOLUTE MAXIMUM RATINGS $T_C = 25$ °C, unless otherwise noted

PARAMETER	SYMBOL	LIMIT	UNIT	
Drain-Source Voltage	$V_{DS}$	500	V	
Gate-Source Voltage	$V_{GS}$	$\pm 30$		
Continuous Drain Current	$V_{GS}$ at 10 V	$T_C = 25$ °C	34	A
		$T_C = 100$ °C	22	
Pulsed Drain Current <sup>a</sup>	$I_{DM}$	140		
Linear Derating Factor		3.6	W/°C	
Single Pulse Avalanche Energy <sup>b</sup>	$E_{AS}$	560	mJ	
Repetitive Avalanche Current <sup>a</sup>	$I_{AR}$	34	A	
Repetitive Avalanche Energy <sup>a</sup>	$E_{AR}$	45	mJ	
Maximum Power Dissipation	$T_C = 25$ °C	$P_D$	450	W
Peak Diode Recovery $dV/dt^c$	$dV/dt$	15	V/ns	
Operating Junction and Storage Temperature Range	$T_J, T_{stg}$	- 55 to + 150	°C	
Soldering Recommendations (Peak Temperature)	for 10 s	300 <sup>d</sup>		
Mounting Torque	6-32 or M3 screw	10	lbf · in	
		1.1	N · m	

#### Notes

- Repetitive rating; pulse width limited by maximum junction temperature (see fig. 11).
- Starting  $T_J = 25$  °C,  $L = 0.97$  mH,  $R_G = 25$   $\Omega$ ,  $I_{AS} = 34$  A (see fig. 12).
- $I_{SD} \leq 34$  A,  $dI/dt \leq 765$  A/ $\mu$ s,  $V_{DD} \leq V_{DS}$ ,  $T_J \leq 150$  °C.
- 1.6 mm from case.

\* Pb containing terminations are not RoHS compliant, exemptions may apply

THERMAL RESISTANCE RATINGS				
PARAMETER	SYMBOL	TYP.	MAX.	UNIT
Maximum Junction-to-Ambient	$R_{thJA}$	-	40	°C/W
Case-to-Sink, Flat, Greased Surface	$R_{thCS}$	0.24	-	
Maximum Junction-to-Case (Drain)	$R_{thJC}$	-	0.28	

### Note

a.  $R_{th}$  is measured at  $T_J$  approximately 90 °C.

SPECIFICATIONS $T_J = 25\text{ °C}$ , unless otherwise noted							
PARAMETER	SYMBOL	TEST CONDITIONS	MIN.	TYP.	MAX.	UNIT	
<b>Static</b>							
Drain-Source Breakdown Voltage	$V_{DS}$	$V_{GS} = 0\text{ V}$ , $I_D = 250\text{ }\mu\text{A}$	500	-	-	V	
$V_{DS}$ Temperature Coefficient	$\Delta V_{DS}/T_J$	Reference to 25 °C, $I_D = 1\text{ mA}$	-	0.12	-	V/°C	
Gate-Source Threshold Voltage	$V_{GS(th)}$	$V_{DS} = V_{GS}$ , $I_D = 250\text{ }\mu\text{A}$	3.0	-	5.0	V	
Gate-Source Leakage	$I_{GSS}$	$V_{GS} = \pm 30\text{ V}$	-	-	$\pm 100$	nA	
Zero Gate Voltage Drain Current	$I_{DSS}$	$V_{DS} = 500\text{ V}$ , $V_{GS} = 0\text{ V}$	-	-	50	$\mu\text{A}$	
		$V_{DS} = 400\text{ V}$ , $V_{GS} = 0\text{ V}$ , $T_J = 125\text{ °C}$	-	-	2.0	mA	
Drain-Source On-State Resistance	$R_{DS(on)}$	$V_{GS} = 10\text{ V}$   $I_D = 20\text{ A}^b$	-	0.125	0.145	$\Omega$	
Forward Transconductance	$g_{fs}$	$V_{DS} = 50\text{ V}$ , $I_D = 20\text{ A}^b$	18	-	-	S	
<b>Dynamic</b>							
Input Capacitance	$C_{iss}$	$V_{GS} = 0\text{ V}$ , $V_{DS} = 25\text{ V}$ , $f = 1.0\text{ MHz}$ , see fig. 5	-	5580	-	pF	
Output Capacitance	$C_{oss}$		-	590	-		
Reverse Transfer Capacitance	$C_{rss}$		-	58	-		
Output Capacitance	$C_{oss}$	$V_{GS} = 0\text{ V}$	$V_{DS} = 1.0\text{ V}$ , $f = 1.0\text{ MHz}$	-	7290	-	
Effective Output Capacitance	$C_{oss\text{ eff.}}$		$V_{DS} = 400\text{ V}$ , $f = 1.0\text{ MHz}$	-	160	-	
Effective Output Capacitance (Energy Related)	$C_{oss\text{ eff. (ER)}}$	$V_{DS} = 0\text{ V to }400\text{ V}^c$	-	320	-		
Total Gate Charge	$Q_g$	$V_{GS} = 10\text{ V}$	$I_D = 34\text{ A}$ , $V_{DS} = 400\text{ V}$ , see fig. 7 and 13 <sup>b</sup>	-	-	230	nC
Gate-Source Charge	$Q_{gs}$			-	-	65	
Gate-Drain Charge	$Q_{gd}$			-	-	110	
Internal Gate Resistance	$R_G$	$f = 1\text{ MHz}$ , open drain		-	1.1	-	$\Omega$
Turn-On Delay Time	$t_{d(on)}$	$V_{DD} = 250\text{ V}$ , $I_D = 34\text{ A}$ , $R_G = 1.2\text{ }\Omega$ , see fig. 10 <sup>b</sup>	-	24	-	ns	
Rise Time	$t_r$		-	100	-		
Turn-Off Delay Time	$t_{d(off)}$		-	42	-		
Fall Time	$t_f$		-	42	-		
<b>Drain-Source Body Diode Characteristics</b>							
Continuous Source-Drain Diode Current	$I_S$	MOSFET symbol showing the integral reverse p - n junction diode 	-	-	34	A	
Pulsed Diode Forward Current <sup>a</sup>	$I_{SM}$		-	-	140		
Body Diode Voltage	$V_{SD}$	$T_J = 25\text{ °C}$ , $I_S = 34\text{ A}$ , $V_{GS} = 0\text{ V}^b$	-	-	1.5	V	
Body Diode Reverse Recovery Time	$t_{rr}$	$T_J = 25\text{ °C}$ , $I_F = 34\text{ A}$	-	170	250	ns	
		$T_J = 125\text{ °C}$ , $dI/dt = 100\text{ A}/\mu\text{s}^b$	-	220	330		
Body Diode Reverse Recovery Charge	$Q_{rr}$	$T_J = 25\text{ °C}$ , $I_S = 34\text{ A}$ , $V_{GS} = 0\text{ V}^b$	-	670	1010	$\mu\text{C}$	
		$T_J = 125\text{ °C}$ , $dI/dt = 100\text{ A}/\mu\text{s}^b$	-	1500	2200		
Reverse Recovery Current	$I_{RRM}$	$T_J = 25\text{ °C}$	-	8.5	-	A	
Forward Turn-On Time	$t_{on}$	Intrinsic turn-on time is negligible (turn-on is dominated by $L_S$ and $L_D$ )					

### Notes

- Repetitive rating; pulse width limited by maximum junction temperature (see fig. 11).
- Pulse width  $\leq 400\text{ }\mu\text{s}$ ; duty cycle  $\leq 2\%$ .
- $C_{oss\text{ eff.}}$  is a fixed capacitance that gives the same charging time as  $C_{oss}$  while  $V_{DS}$  is rising from 0 to 80 %  $V_{DS}$ .  
 $C_{oss\text{ eff. (ER)}}$  is a fixed capacitance that stores the same energy as  $C_{oss}$  while  $V_{DS}$  is rising from 0 to 80 %  $V_{DS}$ .

**TYPICAL CHARACTERISTICS** 25 °C, unless otherwise noted

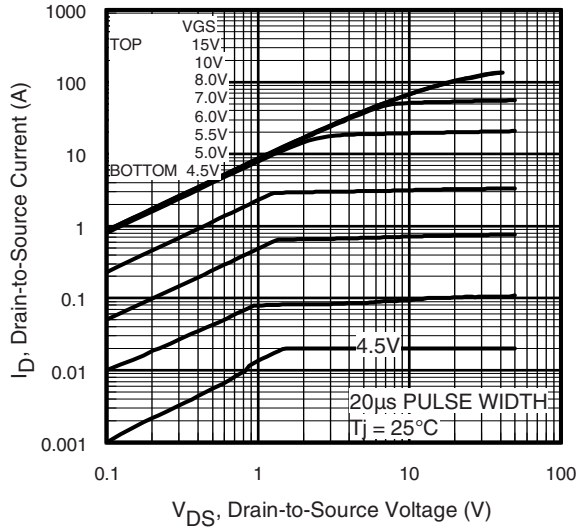

**Fig. 1 - Typical Output Characteristics**

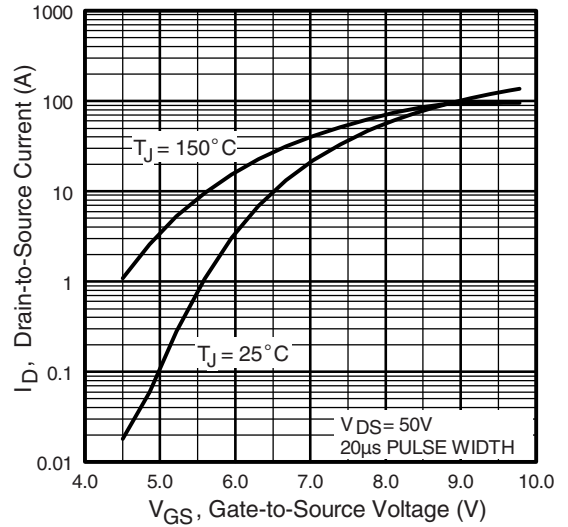

**Fig. 3 - Typical Transfer Characteristics**

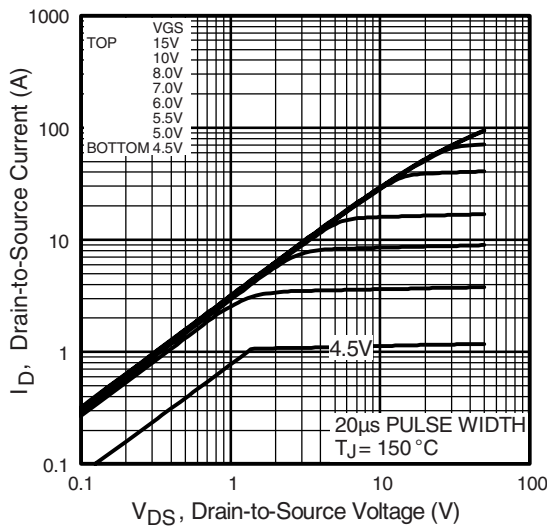

**Fig. 2 - Typical Output Characteristics**

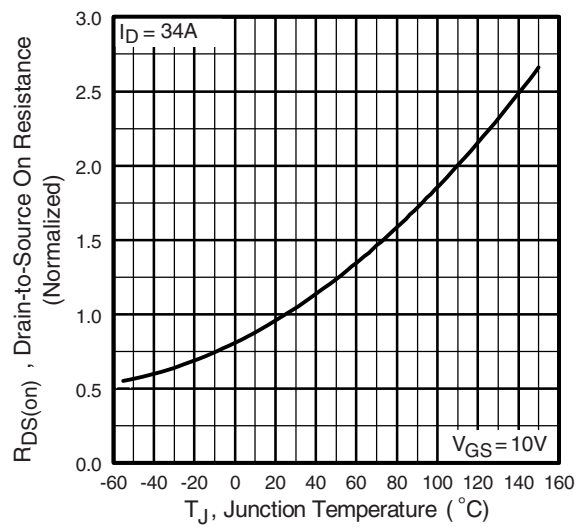

**Fig. 4 - Normalized On-Resistance vs. Temperature**

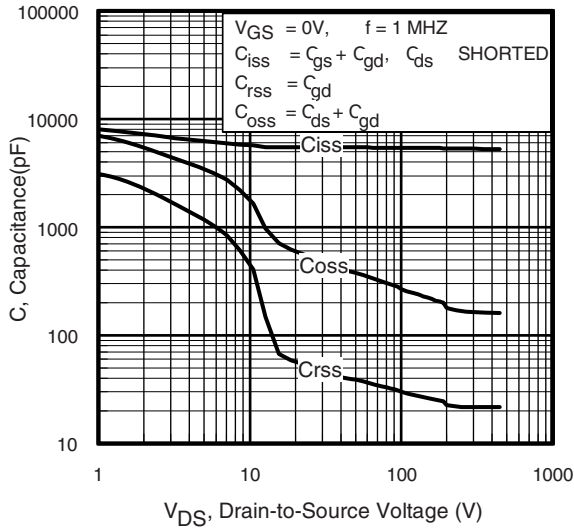

**Fig. 5 - Typical Capacitance vs. Drain-to-Source Voltage**

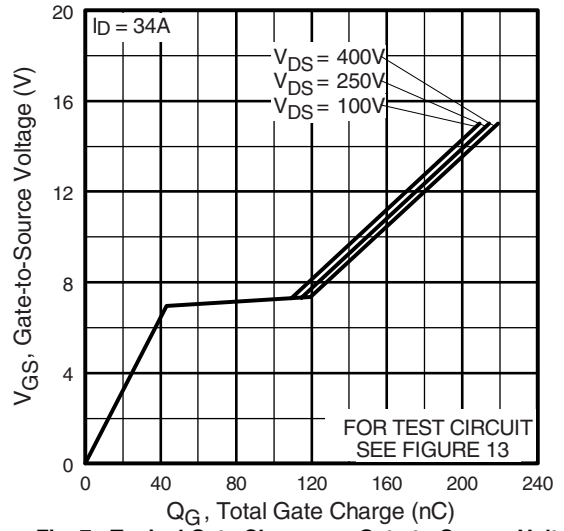

**Fig. 7 - Typical Gate Charge vs. Gate-to-Source Voltage**

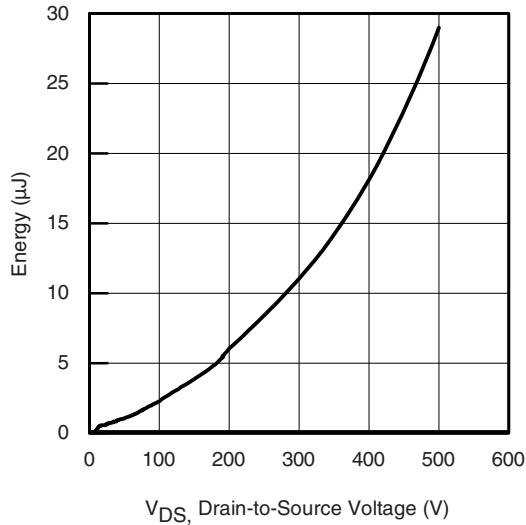

**Fig. 6 - Typical Output Capacitance Stored Energy vs.  $V_{DS}$**

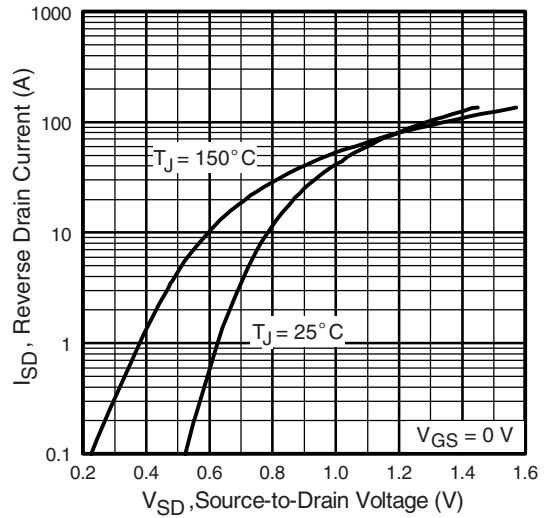

**Fig. 8 - Typical Source Drain Diode Forward Voltage**

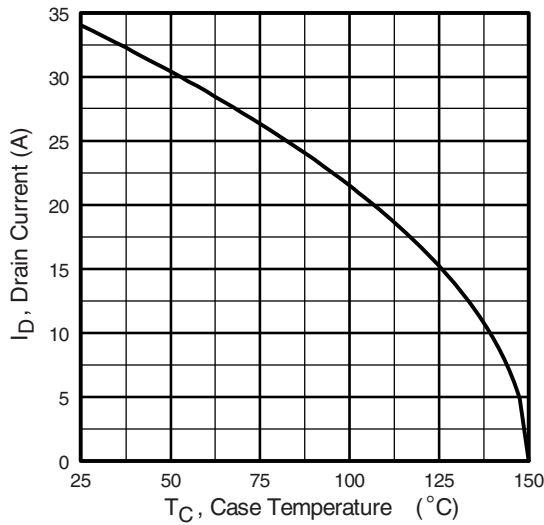

Fig. 9 - Maximum Drain Current vs. Case Temperature

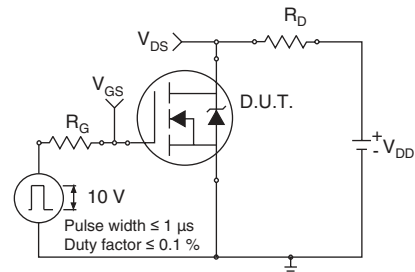

Fig. 10a - Switching Time Test Circuit

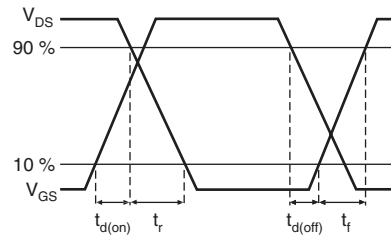

Fig. 10b - Switching Time Waveforms

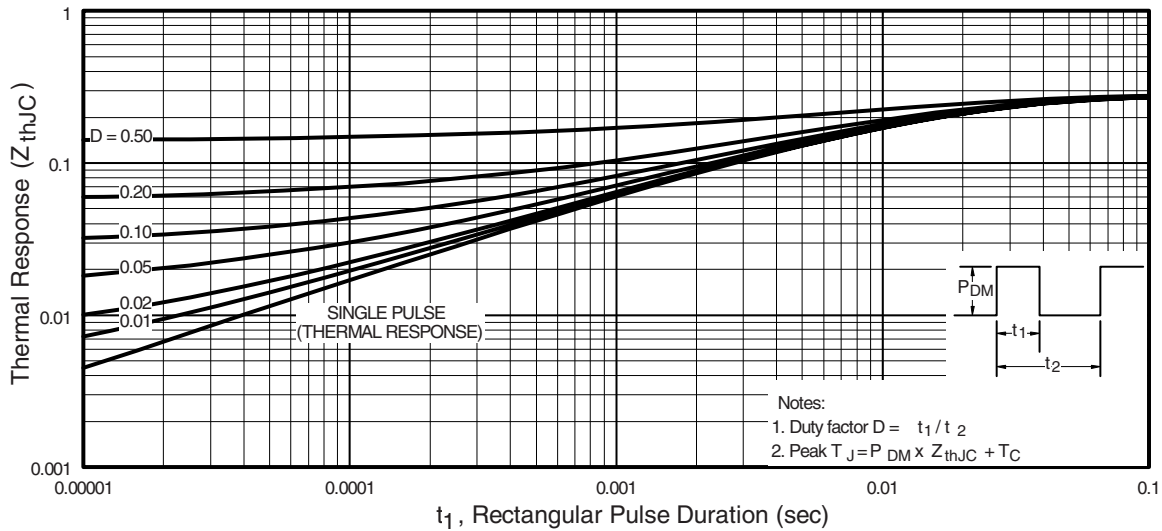

Fig. 11 - Maximum Effective Transient Thermal Impedance, Junction-to-Case

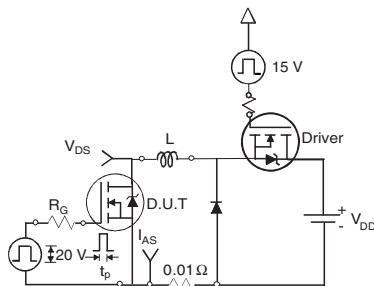

Fig. 12a - Unclamped Inductive Test Circuit

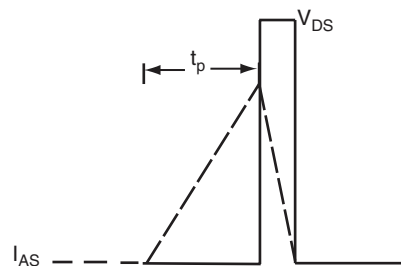

Fig. 12b - Unclamped Inductive Waveforms

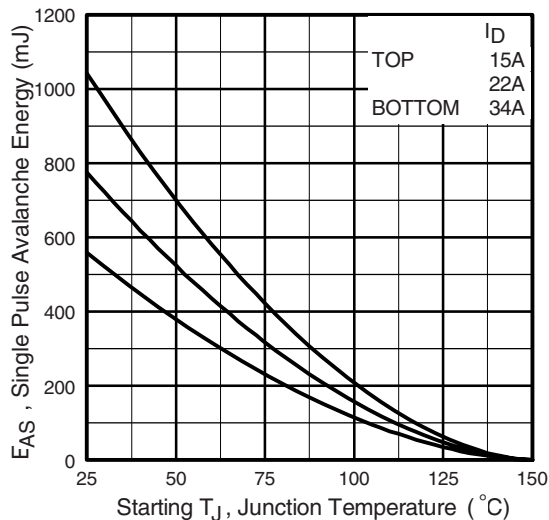

Fig. 12c - Maximum Avalanche Energy vs. Drain Current

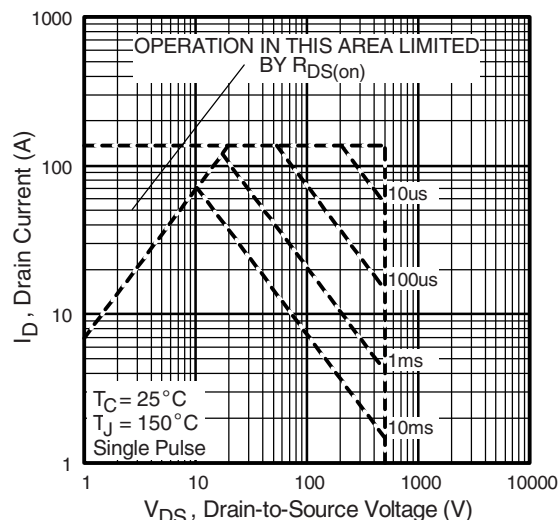

Fig. 12d - Maximum Safe Operating Area

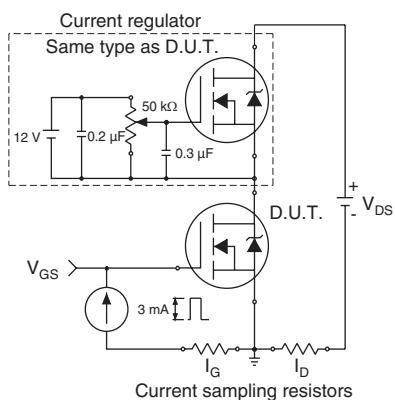

Fig. 13a - Gate Charge Test Circuit

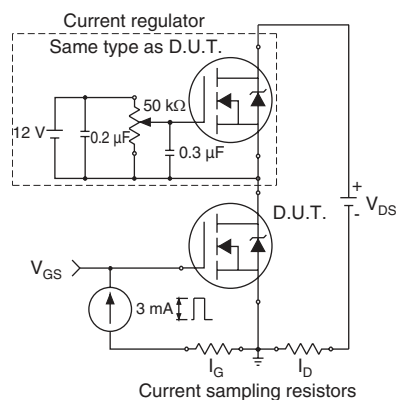
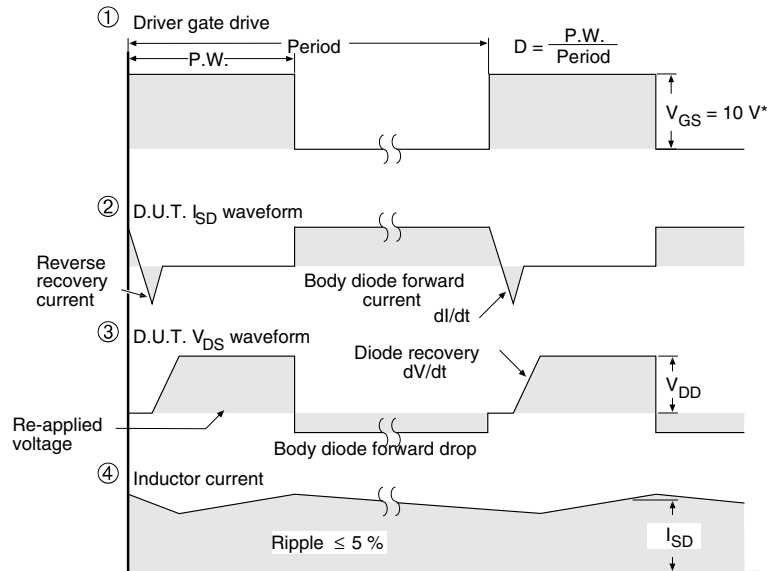
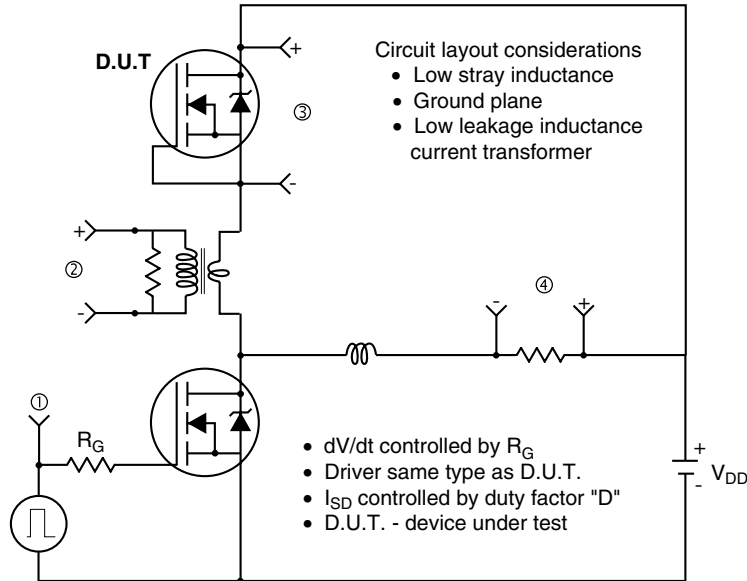

Fig. 13b - Basic Gate Charge Waveform

## Peak Diode Recovery dV/dt Test Circuit



\*  $V_{GS} = 5 V$  for logic level devices

Fig. 14 - For N-Channel

Vishay Siliconix maintains worldwide manufacturing capability. Products may be manufactured at one of several qualified locations. Reliability data for Silicon Technology and Package Reliability represent a composite of all qualified locations. For related documents such as package/tape drawings, part marking, and reliability data, see <http://www.vishay.com/ppg?91257>.



## Disclaimer

All product specifications and data are subject to change without notice.

Vishay Intertechnology, Inc., its affiliates, agents, and employees, and all persons acting on its or their behalf (collectively, "Vishay"), disclaim any and all liability for any errors, inaccuracies or incompleteness contained herein or in any other disclosure relating to any product.

Vishay disclaims any and all liability arising out of the use or application of any product described herein or of any information provided herein to the maximum extent permitted by law. The product specifications do not expand or otherwise modify Vishay's terms and conditions of purchase, including but not limited to the warranty expressed therein, which apply to these products.

No license, express or implied, by estoppel or otherwise, to any intellectual property rights is granted by this document or by any conduct of Vishay.

The products shown herein are not designed for use in medical, life-saving, or life-sustaining applications unless otherwise expressly indicated. Customers using or selling Vishay products not expressly indicated for use in such applications do so entirely at their own risk and agree to fully indemnify Vishay for any damages arising or resulting from such use or sale. Please contact authorized Vishay personnel to obtain written terms and conditions regarding products designed for such applications.

Product names and markings noted herein may be trademarks of their respective owners.