

DWG. NO.
SD-35452-001

SIMILAR ITEM

PROJECT NO.

DO NOT SCALE DRAWING
DIMENSION IN METRIC

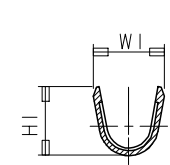
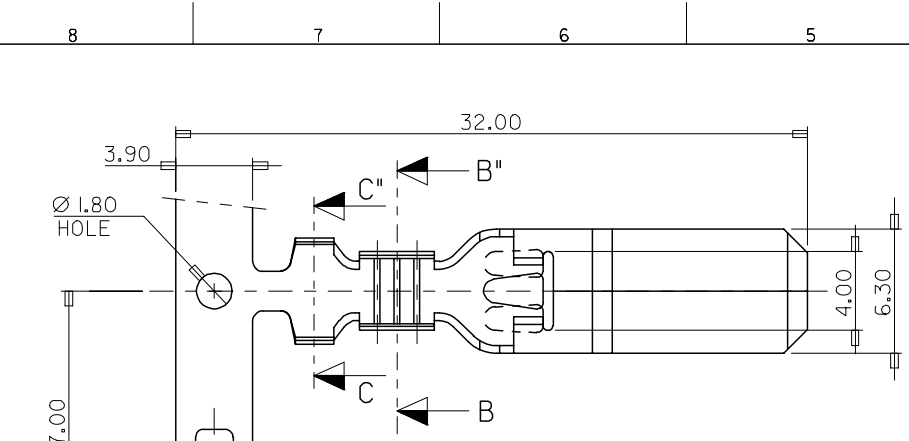

SECTION B-B'

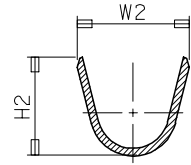

SECTION C-C'

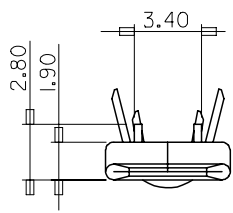

NOTES

1. MATERIAL: BRASS
2. FINISHES: PRE-TIN PLATED

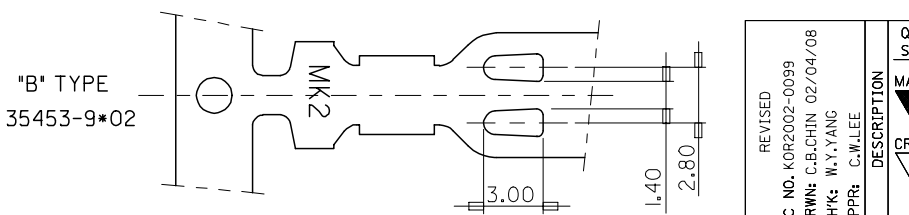
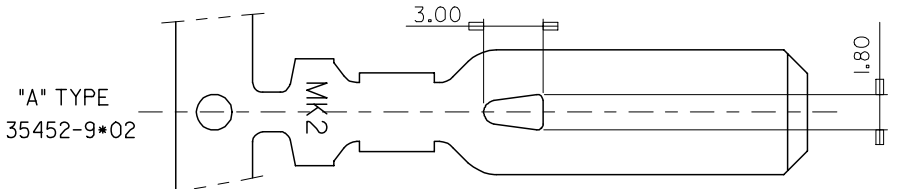
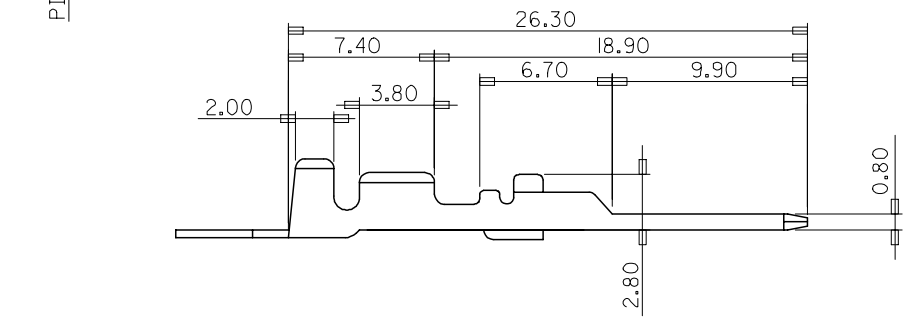

ENG.NO	MATERIAL NO.	W1	H1	W2	H2
3545*-9702	3545*9702	2.8	2.8	3.8	3.8
3545*-9802	3545*9802	3.5	3.5	5.6	5.2
3545*-9902	3545*9902	5.0	4.8	6.3	6.3

* : 2 AND 3

REVISED	EC NO. KOR2002-0099	QUALITY SYMBOLS
DRWN: C.B.CHIN 02/04/08	CHK: W.Y.YANG	MAJOR = 0
APPR: C.W.LEE		CRITICAL = 0
DESCRIPTION		
REV		
A		

GENERAL TOLERANCES: (UNLESS SPECIFIED)	mm	INCH
4 PLACES	±0.	±.
3 PLACES	±0.	±.
2 PLACES	±0.30	±.
1 PLACE	±0.30	±.
ANGULAR: ± 1.0 °		

SCALE 4:1	DESIGN UNITS <input checked="" type="checkbox"/> mm <input type="checkbox"/> INCH
DRAWN BY & DATE W.Y.YANG 97/11/04	
CHECKED BY & DATE B.K.CHOI 97/11/04	
APPROVED BY & DATE C.W.LEE 97/11/04	
CAD FILENAME S35452AA.DGN	
DRAFT WHERE APPLICABLE MUST REMAIN WITHIN DIMENSIONS	

THIRD ANGLE PROJECTION		DIMENSIONS: <input type="checkbox"/> mm <input type="checkbox"/> INCH <input type="checkbox"/> mm <input checked="" type="checkbox"/> mm ONLY		SHT	REV
TITLE: .250 HEAVY TAB-(A),(B)		MATERIAL NO. SEE TABLE		REVISE ON CAD ONLY	
MOLEX MOLEX INCORPORATED		DRAWING NO. SD-35452-001		SHEET NO. 1/1	
THIS DRAWING CONTAINS INFORMATION THAT IS PROPRIETARY TO MOLEX INCORPORATED AND SHOULD NOT BE USED WITHOUT WRITTEN PERMISSION.		MATERIAL NO. SEE TABLE		SIZE B	