



2SC5646A

RF Transistor

4V, 30mA, $f_T=12.5\text{GHz}$, NPN Single SSFP

ON Semiconductor®

<http://onsemi.com>

Features

- Low-noise : $NF=1.5\text{dB}$ typ ($f=2\text{GHz}$)
- High cut-off frequency : $f_T=10\text{GHz}$ typ ($V_{CE}=1\text{V}$)
: $f_T=12.5\text{GHz}$ typ ($V_{CE}=3\text{V}$)
- Low-voltage operation
- High gain : $|S_{21e}|^2=9.5\text{dB}$ typ ($f=2\text{GHz}$)
- Ultrasmall, slim flat-lead package (1.4mm×0.8mm×0.6mm)
- Halogen free compliance

Specifications

Absolute Maximum Ratings at $T_a=25^\circ\text{C}$

Parameter	Symbol	Conditions	Ratings	Unit
Collector-to-Base Voltage	V_{CBO}		9	V
Collector-to-Emitter Voltage	V_{CEO}		4	V
Emitter-to-Base Voltage	V_{EBO}		2	V
Collector Current	I_C		30	mA
Collector Dissipation	P_C		100	mW
Junction Temperature	T_j		150	$^\circ\text{C}$
Storage Temperature	T_{stg}		-55 to +150	$^\circ\text{C}$

Stresses exceeding Maximum Ratings may damage the device. Maximum Ratings are stress ratings only. Functional operation above the Recommended Operating Conditions is not implied. Extended exposure to stresses above the Recommended Operating Conditions may affect device reliability.

Package Dimensions

unit : mm (typ)

7029A-002

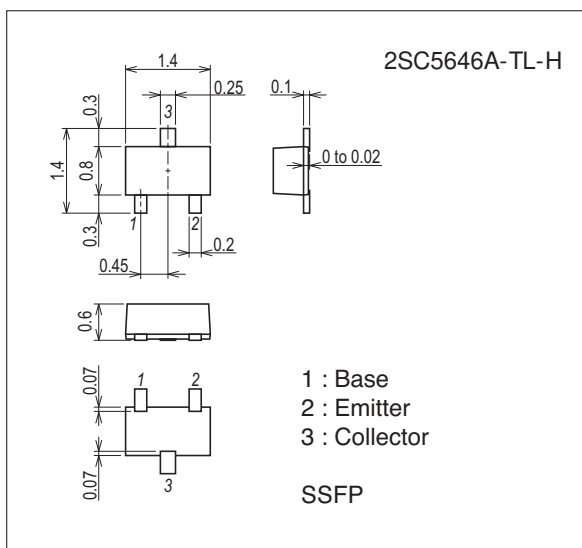

Product & Package Information

- Package : SSFP
- JEITA, JEDEC : SC-81
- Minimum Packing Quantity : 8,000 pcs./reel

Packing Type: TL

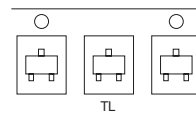

Marking

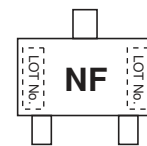

Electrical Connection

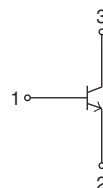

2SC5646A

Electrical Characteristics at Ta=25°C

Parameter	Symbol	Conditions	Ratings			Unit
			min	typ	max	
Collector Cutoff Current	ICBO	V _{CB} =5V, I _E =0A			1.0	μA
Emitter Cutoff Current	IEBO	V _{EB} =1V, I _C =0A			10	μA
DC Current Gain	h _{FE}	V _{CE} =1V, I _C =5mA	100		160	
Gain-Bandwidth Product	f _{T1}	V _{CE} =1V, I _C =5mA	8	10		GHz
	f _{T2}	V _{CE} =3V, I _C =15mA		12.5		GHz
Output Capacitance	C _{ob}	V _{CB} =1V, f=1MHz		0.55	0.7	pF
Reverse Transfer Capacitance	C _{re}				0.4	pF
Forward Transfer Gain	S _{21e} ² ₁	V _{CE} =1V, I _C =5mA, f=2GHz	8	9.5		dB
	S _{21e} ² ₂	V _{CE} =3V, I _C =15mA, f=2GHz		10.5		dB
Noise Figure	NF	V _{CE} =1V, I _C =3mA, f=2GHz		1.5	2.3	dB

Ordering Information

Device	Package	Shipping	memo
2SC5646A-TL-H	SSFP	8,000pcs./reel	Pb Free and Halogen Free

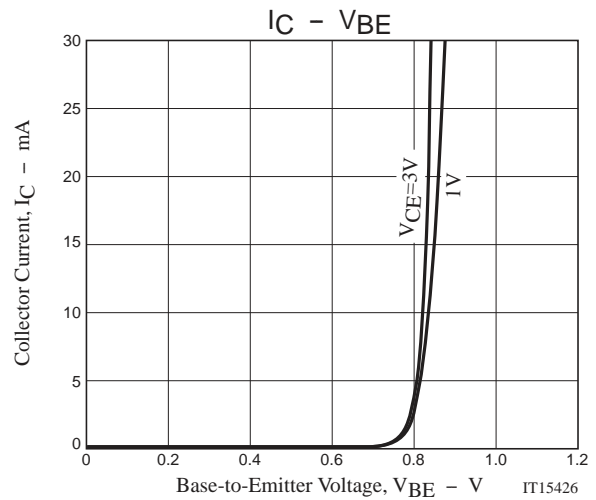
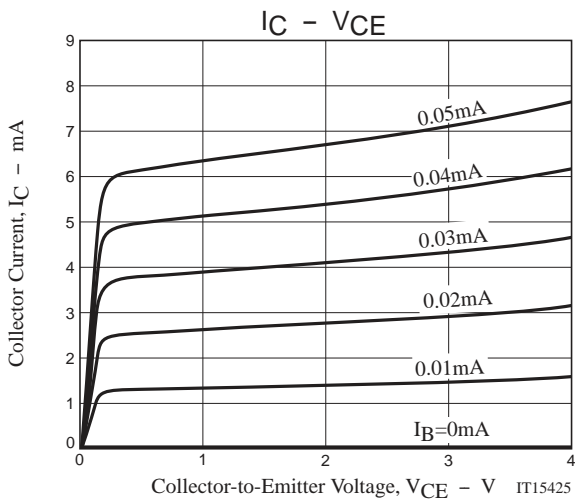

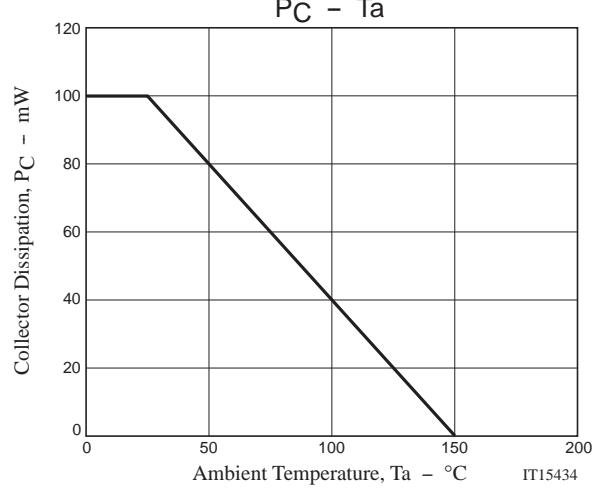
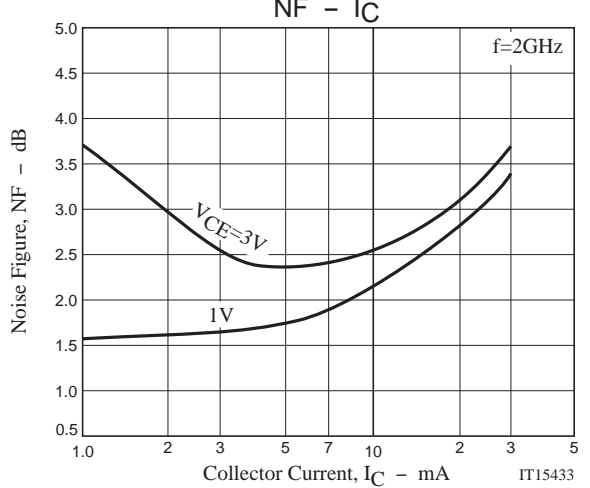
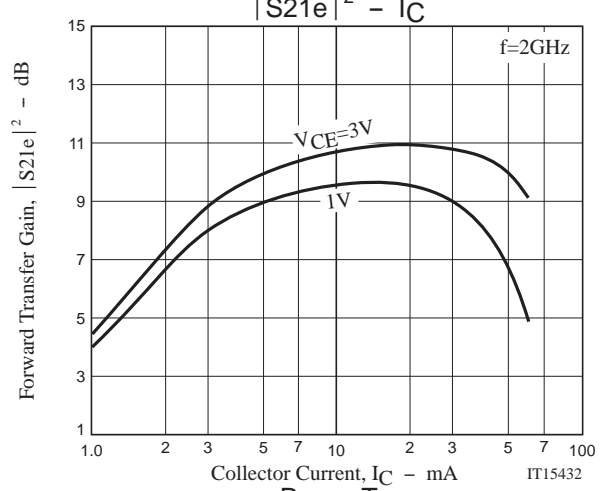
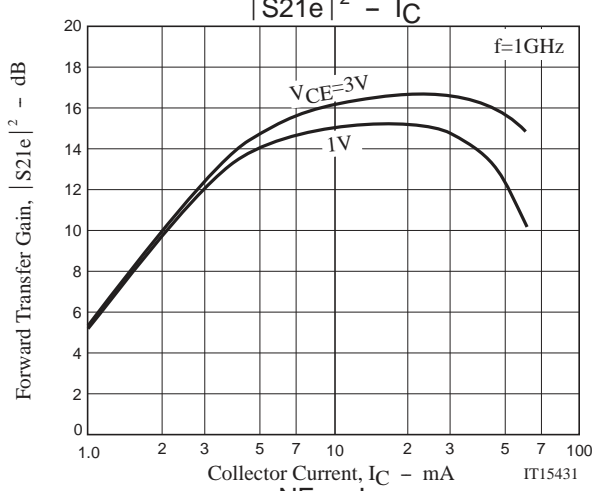
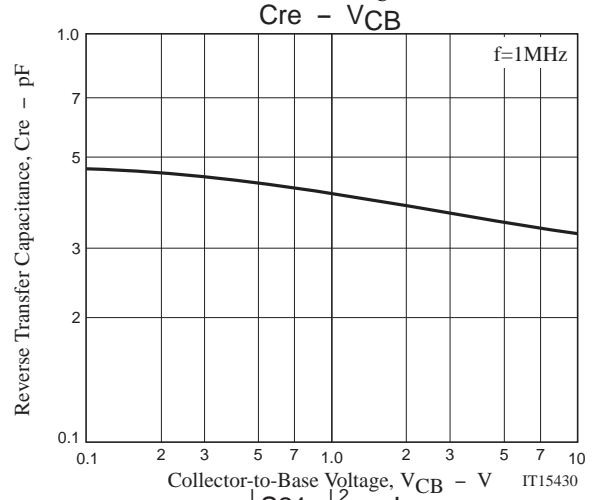
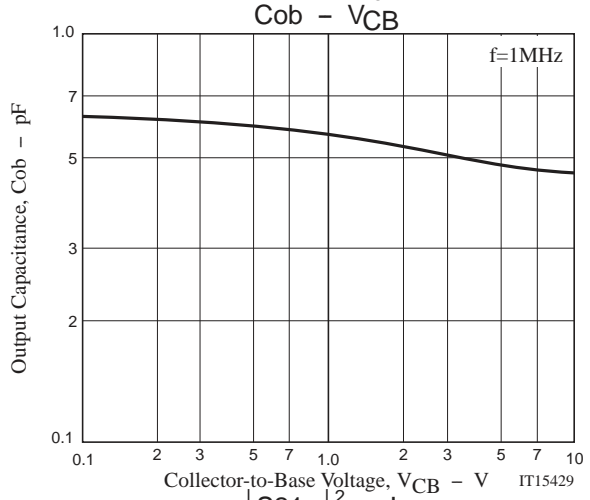
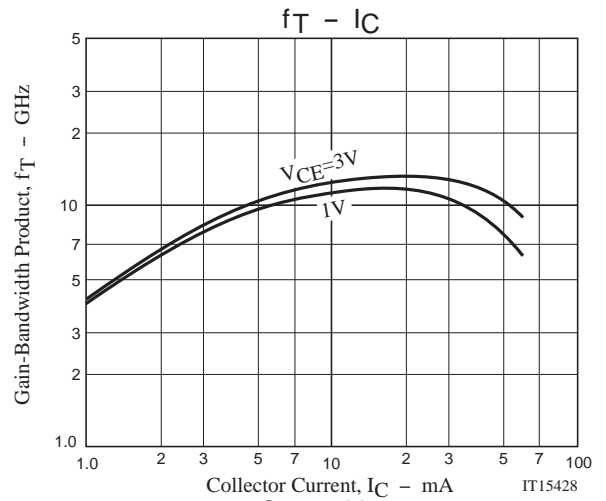
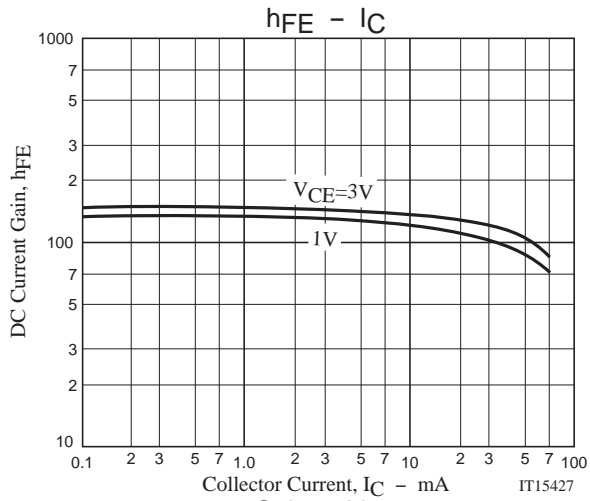

2SC5646A

S Parameters (Common emitter)

$V_{CE}=1V, I_C=1mA, Z_0=50\Omega$

Freq(MHz)	S11	$\angle S11$	S21	$\angle S21$	S12	$\angle S12$	S22	$\angle S22$
200	0.967	-13.5	2.360	164.5	0.050	74.0	0.982	-11.4
400	0.929	-26.2	2.289	150.8	0.093	67.5	0.933	-21.8
600	0.888	-36.3	1.944	138.2	0.128	58.3	0.878	-31.2
800	0.821	-51.9	2.239	128.0	0.156	50.6	0.819	-38.6
1000	0.773	-61.9	2.046	119.0	0.172	44.5	0.763	-45.2
1200	0.724	-72.5	1.952	110.3	0.190	39.5	0.717	-50.9
1400	0.662	-84.6	1.956	101.8	0.198	35.4	0.675	-56.1
1600	0.629	-91.8	1.777	95.0	0.204	31.7	0.642	-60.9
1800	0.589	-101.5	1.720	88.5	0.206	29.3	0.612	-65.0
2000	0.554	-110.4	1.649	82.4	0.208	27.2	0.589	-69.1
2200	0.537	-116.0	1.521	76.7	0.207	25.9	0.569	-73.0
2400	0.510	-124.3	1.473	71.7	0.207	24.8	0.555	-76.4
2600	0.496	-130.1	1.393	67.1	0.203	24.4	0.543	-80.2
2800	0.481	-136.1	1.328	62.6	0.201	24.2	0.533	-83.4
3000	0.468	-142.2	1.280	58.5	0.199	25.1	0.527	-86.8

$V_{CE}=1V, I_C=5mA, Z_0=50\Omega$

Freq(MHz)	S11	$\angle S11$	S21	$\angle S21$	S12	$\angle S12$	S22	$\angle S22$
200	0.826	-30.9	9.413	151.9	0.039	70.9	0.866	-27.2
400	0.679	-61.6	8.593	130.9	0.068	56.4	0.681	-44.5
600	0.576	-83.1	7.017	117.1	0.082	49.2	0.547	-55.2
800	0.485	-105.2	6.080	105.2	0.091	47.6	0.457	-61.3
1000	0.436	-120.0	5.151	97.1	0.098	48.0	0.398	-66.0
1200	0.408	-131.3	4.423	90.8	0.109	48.1	0.362	-69.5
1400	0.388	-140.8	3.896	85.3	0.115	49.4	0.331	-72.8
1600	0.376	-148.8	3.465	80.6	0.125	50.8	0.311	-76.1
1800	0.368	-155.4	3.122	76.4	0.132	51.6	0.297	-78.6
2000	0.363	-161.1	2.846	72.6	0.141	52.5	0.289	-81.8
2200	0.361	-166.5	2.621	68.8	0.150	53.6	0.280	-84.6
2400	0.358	-171.3	2.426	65.4	0.160	54.1	0.276	-87.5
2600	0.358	-175.7	2.262	62.1	0.171	54.7	0.273	-90.5
2800	0.357	-179.9	2.125	58.9	0.181	54.9	0.271	-93.3
3000	0.356	176.4	2.003	56.1	0.190	55.7	0.271	-96.4

$V_{CE}=1V, I_C=10mA, Z_0=50\Omega$

Freq(MHz)	S11	$\angle S11$	S21	$\angle S21$	S12	$\angle S12$	S22	$\angle S22$
200	0.680	-49.0	14.963	141.8	0.037	61.7	0.745	-37.5
400	0.504	-91.9	11.934	117.7	0.051	54.2	0.514	-55.1
600	0.426	-116.8	8.944	104.8	0.064	52.9	0.393	-63.2
800	0.389	-133.6	7.032	96.3	0.073	55.8	0.324	-68.3
1000	0.371	-145.4	5.768	90.2	0.083	57.7	0.282	-71.5
1200	0.362	-154.0	4.888	85.2	0.094	59.1	0.255	-74.0
1400	0.356	-161.3	4.240	80.8	0.105	60.4	0.239	-77.0
1600	0.352	-166.8	3.750	76.8	0.116	60.2	0.226	-79.4
1800	0.354	-172.1	3.363	73.2	0.128	61.2	0.221	-82.9
2000	0.353	-176.4	3.059	69.8	0.139	62.3	0.215	-86.1
2200	0.353	179.5	2.804	66.5	0.151	61.9	0.211	-88.9
2400	0.354	175.8	2.592	63.4	0.163	62.0	0.210	-91.8
2600	0.357	172.4	2.417	60.5	0.176	62.0	0.210	-95.3
2800	0.357	169.1	2.263	57.5	0.187	62.0	0.212	-98.4
3000	0.357	166.1	2.133	54.8	0.200	61.4	0.215	-101.4

2SC5646A

S Parameters (Common emitter)

$V_{CE}=1V, I_C=20mA, Z_O=50\Omega$

Freq(MHz)	S11	$\angle S11$	S21	$\angle S21$	S12	$\angle S12$	S22	$\angle S22$
200	0.492	-82.8	19.544	128.7	0.030	59.2	0.601	-47.3
400	0.399	-124.0	13.186	107.6	0.042	57.9	0.381	-61.9
600	0.377	-143.8	9.339	97.6	0.052	61.4	0.284	-68.1
800	0.367	-155.4	7.181	91.0	0.065	64.4	0.235	-71.6
1000	0.364	-163.4	5.837	85.9	0.077	66.8	0.209	-74.0
1200	0.363	-169.7	4.913	81.5	0.089	66.5	0.192	-76.9
1400	0.363	-174.8	4.250	77.7	0.102	67.0	0.182	-79.9
1600	0.364	-178.8	3.751	74.1	0.114	67.7	0.178	-82.7
1800	0.365	177.3	3.361	70.8	0.128	67.4	0.174	-85.9
2000	0.367	173.9	3.049	67.6	0.142	67.5	0.173	-89.1
2200	0.369	170.8	2.798	64.5	0.154	67.0	0.174	-93.0
2400	0.372	167.9	2.584	61.5	0.166	66.4	0.175	-95.8
2600	0.373	165.1	2.403	58.6	0.178	66.0	0.178	-98.7
2800	0.375	162.3	2.254	55.9	0.194	65.3	0.180	-102.0
3000	0.378	159.8	2.119	53.2	0.207	64.8	0.185	-104.8

$V_{CE}=3V, I_C=1mA, Z_O=50\Omega$

Freq(MHz)	S11	$\angle S11$	S21	$\angle S21$	S12	$\angle S12$	S22	$\angle S22$
200	0.969	-12.0	2.363	165.7	0.043	77.2	0.981	-9.8
400	0.942	-23.4	2.289	153.2	0.076	71.1	0.950	-18.6
600	0.906	-32.6	1.955	141.5	0.107	62.0	0.903	-27.0
800	0.847	-46.8	2.285	131.9	0.131	54.9	0.853	-33.7
1000	0.804	-55.8	2.076	123.6	0.149	48.8	0.803	-39.9
1200	0.755	-65.9	2.018	115.0	0.163	44.0	0.761	-45.1
1400	0.694	-77.3	2.042	106.9	0.173	40.0	0.721	-49.8
1600	0.662	-84.0	1.857	100.1	0.179	35.6	0.691	-54.3
1800	0.618	-93.6	1.822	93.6	0.182	33.6	0.660	-58.2
2000	0.579	-102.1	1.755	87.5	0.183	31.4	0.637	-62.0
2200	0.560	-107.6	1.616	81.9	0.183	30.1	0.616	-65.6
2400	0.529	-116.0	1.582	76.7	0.182	29.1	0.600	-68.9
2600	0.510	-121.7	1.492	72.0	0.181	28.7	0.588	-72.4
2800	0.493	-127.9	1.428	67.5	0.180	29.6	0.577	-75.5
3000	0.475	-134.3	1.381	63.3	0.177	29.8	0.569	-78.8

$V_{CE}=3V, I_C=5mA, Z_O=50\Omega$

Freq(MHz)	S11	$\angle S11$	S21	$\angle S21$	S12	$\angle S12$	S22	$\angle S22$
200	0.849	-26.5	9.604	154.4	0.034	68.7	0.895	-22.2
400	0.716	-52.4	8.894	134.9	0.056	59.5	0.736	-37.2
600	0.615	-71.2	7.356	121.6	0.072	52.4	0.605	-46.2
800	0.503	-92.9	6.628	109.2	0.081	50.8	0.519	-51.4
1000	0.441	-107.5	5.685	100.8	0.088	50.2	0.460	-54.9
1200	0.402	-118.7	4.918	94.3	0.098	51.3	0.419	-57.5
1400	0.373	-129.0	4.350	88.6	0.104	52.5	0.390	-60.0
1600	0.355	-137.2	3.872	83.8	0.112	53.4	0.369	-62.3
1800	0.343	-144.4	3.502	79.5	0.120	54.1	0.352	-64.6
2000	0.332	-151.2	3.197	75.5	0.129	55.6	0.340	-67.1
2200	0.327	-156.8	2.940	71.8	0.136	56.2	0.332	-69.5
2400	0.322	-162.0	2.724	68.4	0.146	57.1	0.326	-72.0
2600	0.320	-167.1	2.541	65.0	0.156	58.0	0.322	-74.8
2800	0.319	-171.4	2.384	61.9	0.165	58.4	0.319	-77.2
3000	0.317	-175.6	2.247	58.9	0.175	58.8	0.316	-80.1

2SC5646A

S Parameters (Common emitter)

$V_{CE}=3V$, $I_C=10mA$, $Z_O=50\Omega$

Freq(MHz)	S11	$\angle S11$	S21	$\angle S21$	S12	$\angle S12$	S22	$\angle S22$
200	0.721	-40.7	15.749	145.6	0.028	64.8	0.794	-30.5
400	0.531	-78.2	13.000	122.1	0.046	57.2	0.583	-44.9
600	0.428	-102.2	9.969	108.6	0.056	58.2	0.458	-51.3
800	0.372	-120.2	7.950	99.6	0.066	56.8	0.387	-54.3
1000	0.342	-133.0	6.549	93.0	0.077	59.1	0.344	-56.1
1200	0.325	-142.5	5.564	87.9	0.084	60.8	0.314	-57.6
1400	0.316	-150.8	4.833	83.4	0.095	61.6	0.296	-59.3
1600	0.309	-157.5	4.276	79.4	0.106	63.2	0.284	-61.2
1800	0.306	-162.9	3.835	75.8	0.117	63.7	0.275	-63.4
2000	0.304	-168.1	3.486	72.4	0.128	64.3	0.268	-65.7
2200	0.304	-172.5	3.197	69.2	0.138	64.2	0.263	-67.8
2400	0.304	-176.5	2.955	66.1	0.149	64.3	0.261	-70.8
2600	0.305	-179.5	2.753	63.1	0.161	64.6	0.260	-73.5
2800	0.308	-176.0	2.576	60.2	0.172	64.3	0.258	-76.4
3000	0.308	-172.8	2.423	57.5	0.184	64.2	0.259	-78.9

$V_{CE}=3V$, $I_C=20mA$, $Z_O=50\Omega$

Freq(MHz)	S11	$\angle S11$	S21	$\angle S21$	S12	$\angle S12$	S22	$\angle S22$
200	0.537	-63.4	22.589	134.4	0.024	61.2	0.673	-37.7
400	0.387	-106.2	15.289	111.6	0.038	58.4	0.458	-48.4
600	0.336	-128.8	10.917	100.7	0.047	62.9	0.356	-51.5
800	0.318	-143.0	8.424	93.7	0.059	65.4	0.304	-52.6
1000	0.309	-152.8	6.849	88.4	0.069	69.0	0.275	-53.4
1200	0.306	-160.1	5.773	84.0	0.081	68.8	0.258	-54.5
1400	0.305	-166.3	4.995	80.1	0.092	69.1	0.247	-56.1
1600	0.303	-171.2	4.410	76.6	0.103	70.3	0.240	-58.2
1800	0.304	-175.4	3.947	73.3	0.116	69.6	0.234	-60.1
2000	0.304	-179.2	3.576	70.1	0.128	69.2	0.233	-62.6
2200	0.308	-177.4	3.275	67.1	0.139	69.2	0.230	-65.6
2400	0.310	-174.1	3.027	64.3	0.152	69.3	0.229	-68.1
2600	0.310	-170.9	2.815	61.5	0.164	68.3	0.229	-71.1
2800	0.314	-168.1	2.639	58.7	0.176	68.2	0.231	-74.1
3000	0.315	-165.2	2.479	56.2	0.187	67.8	0.232	-76.9

Embossed Taping Specification

2SC5646A-TL-H

1. Packing Format

Package Name	Carrier Tape Type	Maximum Number of devices contained (pcs)			Packing format	
		Reel	Inner box	Outer box	Inner BOX (C-1)	Outer BOX (A-7)
SSFP	SSFP	8,000	40,000	240,000	5 reels contained Dimensions:mm (external) 183×72×185	6 inner boxes contained Dimensions:mm (external) 440×195×210

Packing method

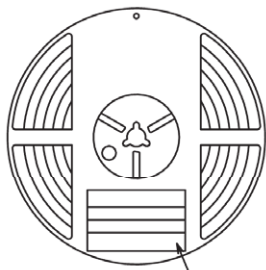

Reel label

Reel label, Inner box label
(unit:mm)

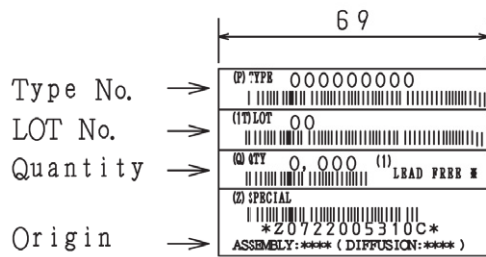

Outer box label

It is a label at the time of factory shipments. The form of a label may change in physical distribution process.

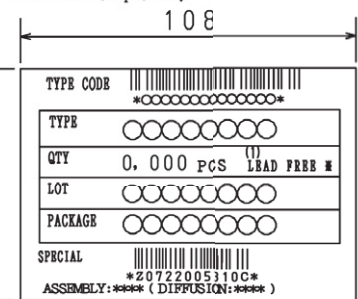

NOTE (1)

The LEAD FREE * description shows that the surface treatment of the terminal is lead free.

Label	JEITA Phase
LEAD FREE 3	JEITA Phase 3A
LEAD FREE 4	JEITA Phase 3

2. Taping configuration

2-1. Carrier tape size (unit:mm)

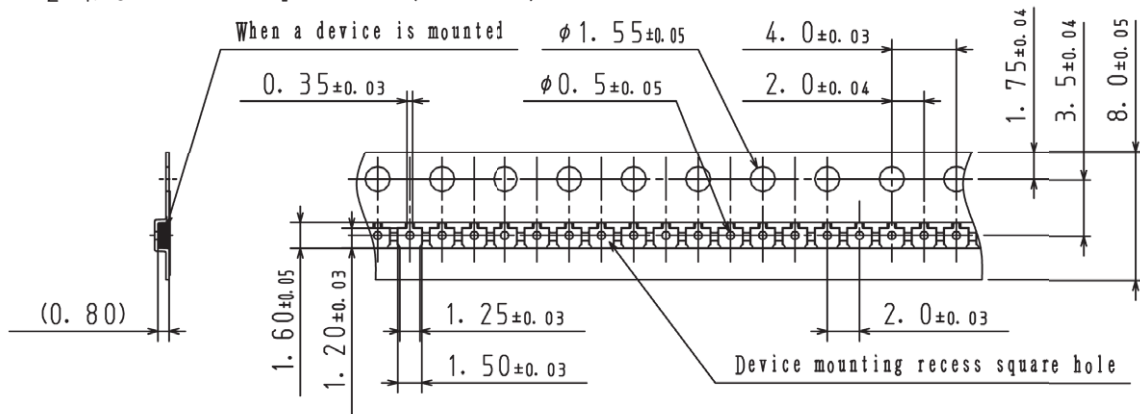

2-2. Device placement direction

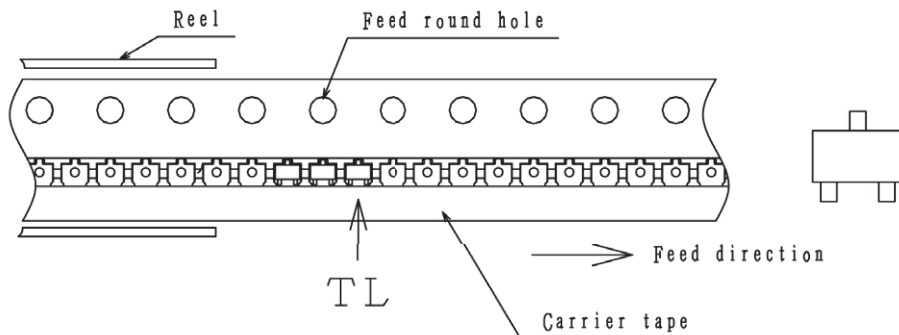

Those with pin 1 index on the feed hole side.....TL

2SC5646A

Outline Drawing

2SC5646A-TL-H

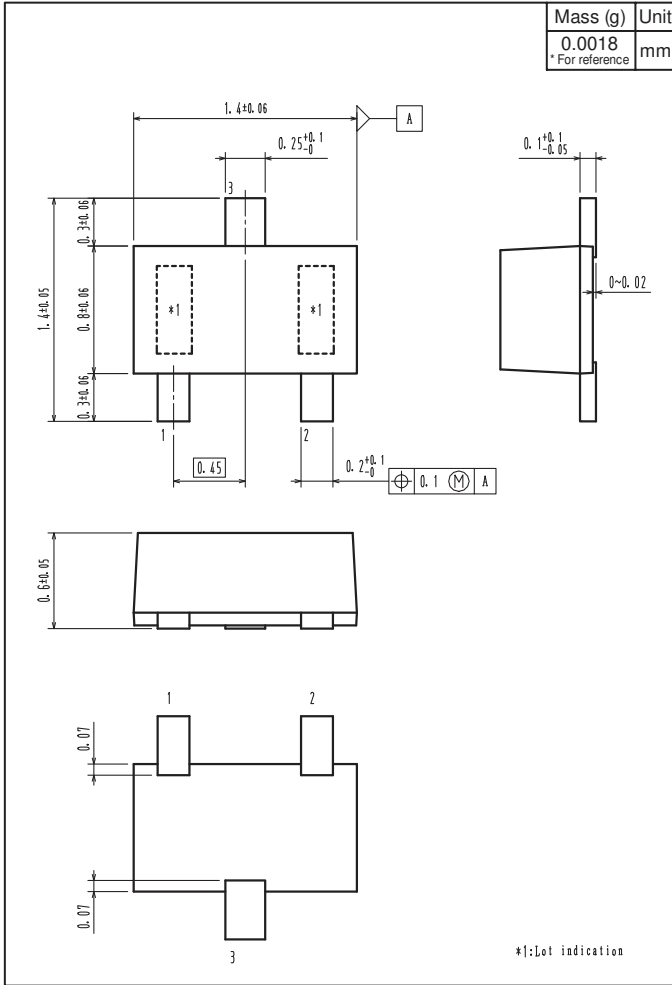

Land Pattern Example

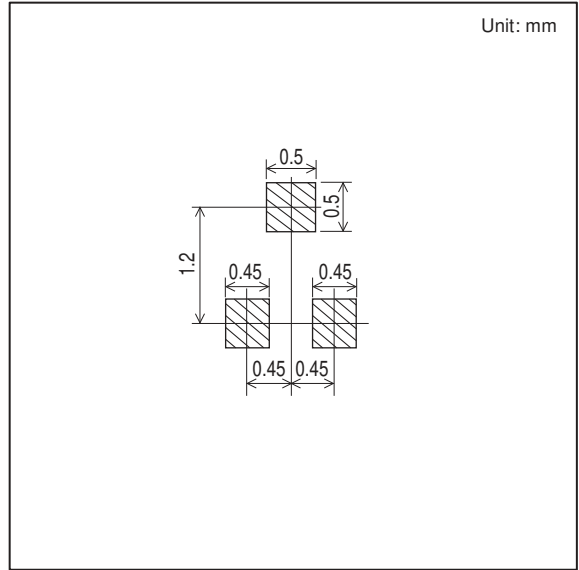

ON Semiconductor and the ON logo are registered trademarks of Semiconductor Components Industries, LLC (SCILLC). SCILLC owns the rights to a number of patents, trademarks, copyrights, trade secrets, and other intellectual property. A listing of SCILLC's product/patent coverage may be accessed at www.onsemi.com/site/pdf/Patent-Marking.pdf. SCILLC reserves the right to make changes without further notice to any products herein. SCILLC makes no warranty, representation or guarantee regarding the suitability of its products for any particular purpose, nor does SCILLC assume any liability arising out of the application or use of any product or circuit, and specifically disclaims any and all liability, including without limitation special, consequential or incidental damages. "Typical" parameters which may be provided in SCILLC data sheets and/or specifications can and do vary in different applications and actual performance may vary over time. All operating parameters, including "Typicals" must be validated for each customer application by customer's technical experts. SCILLC does not convey any license under its patent rights nor the rights of others. SCILLC products are not designed, intended, or authorized for use as components in systems intended for surgical implant into the body, or other applications intended to support or sustain life, or for any other application in which the failure of the SCILLC product could create a situation where personal injury or death may occur. Should Buyer purchase or use SCILLC products for any such unintended or unauthorized application, Buyer shall indemnify and hold SCILLC and its officers, employees, subsidiaries, affiliates, and distributors harmless against all claims, costs, damages, and expenses, and reasonable attorney fees arising out of, directly or indirectly, any claim of personal injury or death associated with such unintended or unauthorized use, even if such claim alleges that SCILLC was negligent regarding the design or manufacture of the part. SCILLC is an Equal Opportunity/Affirmative Action Employer. This literature is subject to all applicable copyright laws and is not for resale in any manner.