



## MIC5314

### Low Voltage Dual 300mA LDO with Power on Reset

## General Description

The MIC5314 is a high performance, dual low input voltage, low dropout regulator with Power On Reset (POR). Major features include two 300mA LDOs, input voltage down to 1.7V, ultra low drop out of 85mV at full load, and Power On Reset. Each LDO has its own low voltage input for system flexibility. The low input voltages and low drop out operation provides high efficiency by reducing the input to output voltage step which minimizes the regulator power loss. An adjustable delay time POR output is provided for the second regulator for design flexibility.

Ideal for battery operated applications; the MIC5314 offers 1% accuracy and low ground current to increase light load efficiency. The MIC5314 can also be put into a zero-off-mode current state, drawing virtually no current when disabled.

The MIC5314 is available in fixed output voltages in the 12-pin 2.5mm x 2.5mm Thin MLF<sup>®</sup> leadless package.

Data sheets and support documentation can be found on Micrel's web site at: [www.micrel.com](http://www.micrel.com).

## Features

- 300mA output current for each LDO
- Dual low voltage regulator inputs: 1.7V to 5.5V
- Low output voltage range: 0.8V to 2.0V
- Ultra-low dropout voltage of 85mV @ 300mA
- Power On Reset output with adjustable delay
- Stable with 1 $\mu$ F ceramic output capacitors
- Very fast transient response
- Thermal shutdown and current limit protection
- Tiny 12-pin 2.5mm x 2.5mm Thin MLF<sup>®</sup> package

## Applications

- Mobile Phones
- GPS and Navigation Devices
- Portable Media Players
- Digital still and video cameras
- PDAs
- Portable electronics

## Typical Application

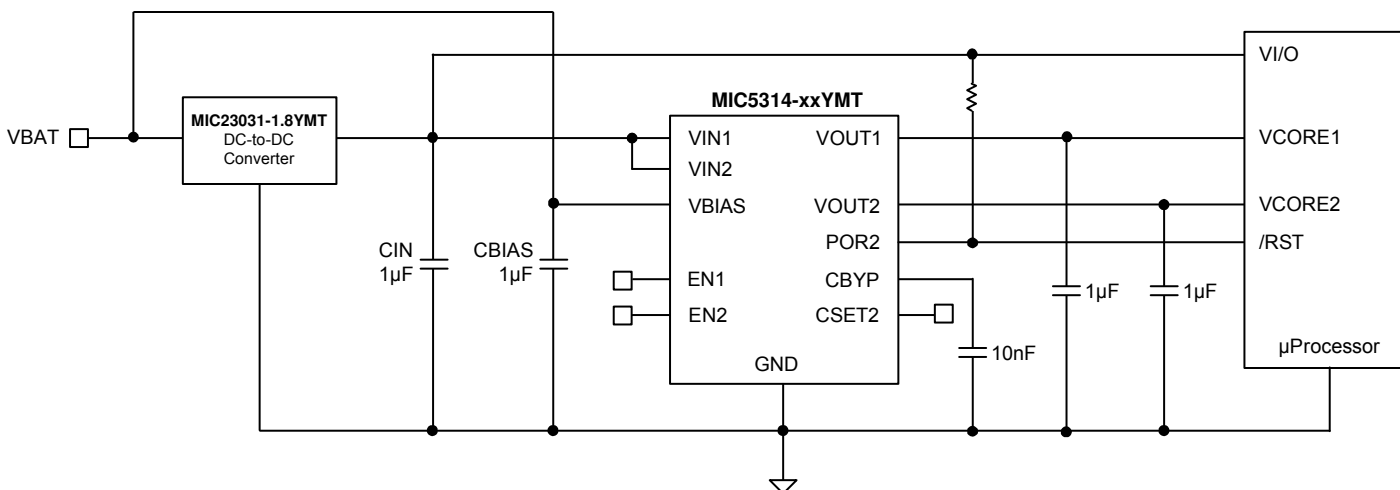

MLF and *MicroLeadFrame* are registered trademarks of Amkor Technology, Inc.

Micrel Inc. • 2180 Fortune Drive • San Jose, CA 95131 • USA • tel +1 (408) 944-0800 • fax + 1 (408) 474-1000 • <http://www.micrel.com>

## Ordering Information

Part Number	Manufacturing Part Number	Marking <sup>(1)</sup>	Voltage <sup>(2)</sup>	Junction Temp. Range	Package <sup>(3)</sup>
MIC5314-1.5/1.0YMT	MIC5314-FCYMT	QFRC	1.5V/1.0V	-40°C to +125°C	12-Pin 2.5mm x 2.5mm Thin MLF <sup>®</sup>
MIC5314-1.5/1.1YMT	MIC5314-F3YMT	QFR3	1.5V/1.1V	-40°C to +125°C	12-Pin 2.5mm x 2.5mm Thin MLF <sup>®</sup>
MIC5314-1.5/1.2YMT	MIC5314-F4YMT	QFR4	1.5V/1.2V	-40°C to +125°C	12-Pin 2.5mm x 2.5mm Thin MLF <sup>®</sup>
MIC5314-1.5/1.3YMT	MIC5314-F5YMT	QFR5	1.5V/1.3V	-40°C to +125°C	12-Pin 2.5mm x 2.5mm Thin MLF <sup>®</sup>
MIC5314-1.5/1.4YMT	MIC5314-F6YMT	QFR6	1.5V/1.4V	-40°C to +125°C	12-Pin 2.5mm x 2.5mm Thin MLF <sup>®</sup>
MIC5314-1.5/1.5YMT	MIC5314-FFYMT	QFRF	1.5V/1.5V	-40°C to +125°C	12-Pin 2.5mm x 2.5mm Thin MLF <sup>®</sup>
MIC5314-1.8/1.2YMT	MIC5314-G4YMT	QGR4	1.8V/1.2V	-40°C to +125°C	12-Pin 2.5mm x 2.5mm Thin MLF <sup>®</sup>
MIC5314-1.8/1.8YMT	MIC5314-GGYMT	QGRG	1.8V/1.8V	-40°C to +125°C	12-Pin 2.5mm x 2.5mm Thin MLF <sup>®</sup>

### Notes:

- Pin 1 identifier = ▲.
- For other voltage option, contact Micrel Marketing for details
- MLF<sup>®</sup> is a GREEN RoHS compliant package. Lead finish is NiPdAu. Mold compound is Halogen Free.

## Pin Configuration

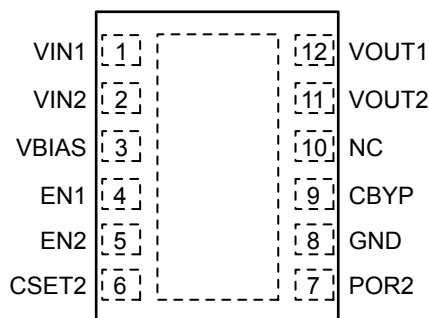

12-Pin 2.5mm x 2.5mm Thin MLF<sup>®</sup> (MT)

## Pin Description

Pin Number	Pin Name	Pin Function
1	VIN1	Voltage Input for LDO1.
2	VIN2	Voltage Input for LDO2.
3	VBIAS	Bias Input Voltage.
4	EN1	Enable Input for LDO1. Active High Input. Logic High = On; Logic Low = Off; Do not leave floating.
5	EN2	Enable Input for LDO2. Active High Input. Logic High = On; Logic Low = Off; Do not leave floating.
6	CSET2	Delay Set Input for POR2. Connect an external capacitor to GND to set the delay for POR2. When left open, there is no delay. Do not ground this pin.
7	POR2	Power-on Reset for LDO2.
8	GND	Ground.
9	CBYP	Bypass: Connect a capacitor to ground to improve output noise and PSRR.
10	NC	No Connect. Not internally connected.
11	VOUT2	Output of regulator 2.
12	VOUT1	Output of regulator 1.

**Absolute Maximum Ratings<sup>(1)</sup>**

Main Input Voltage ( $V_{IN1}$ , $V_{IN2}$ ).....	0V to $V_{BIAS}$
Bias Supply Voltage ( $V_{BIAS}$ ).....	0V to +6V
Enable Input Voltage ( $V_{EN1}$ , $V_{EN2}$ ) .....	0V to $V_{BIAS}$
POR Voltage ( $V_{POR2}$ ) .....	0V to $V_{BIAS}$
Power Dissipation .....	Internally Limited <sup>(3)</sup>
Lead Temperature (soldering, 3sec.).....	260°C
Storage Temperature ( $T_s$ ) .....	-65°C to +150°C
ESD Rating <sup>(4)</sup> .....	2kV

**Operating Ratings<sup>(2)</sup>**

Supply voltage ( $V_{IN1}$ , $V_{IN2}$ ).....	+1.7V to $V_{BIAS}$
Bias Supply Voltage ( $V_{BIAS}$ ) .....	2.5V to +5.5V
Enable Input Voltage ( $V_{EN1}$ , $V_{EN2}$ ) .....	0V to $V_{BIAS}$
POR Voltage ( $V_{POR2}$ ).....	0V to $V_{BIAS}$
Junction Temperature ( $T_J$ ).....	-40°C to +125°C
Junction Thermal Resistance 2.5mm x 2.5mm Thin MLF-12 ( $\theta_{JA}$ ).....	70°C/W

**Electrical Characteristics<sup>(4)</sup>**

$V_{BIAS} = 3.6V$ ;  $V_{IN1} = V_{IN2} = V_{OUT}$  (Highest of two regulators) + 1V;  $C_{BIAS} = C_{OUT} = 1.0\mu F$ ,  $C_{BYP} = 0.01\mu F$ ,  $I_{OUT} = 100\mu A$ ;  
 $T_J = 25^\circ C$ , **bold** values indicate -40°C to + 125°C; unless noted.

Parameter	Condition	Min	Typ	Max	Units
Output Voltage Accuracy	Variation from nominal $V_{OUT1}$ & $V_{OUT2}$	-1.0		+1.0	%
	Variation from nominal $V_{OUT1}$ & $V_{OUT2}$	<b>-2.0</b>		<b>+2.0</b>	%
$V_{IN}$ Line Regulation	$V_{IN} = V_{OUT} + 1V$ to 5.5V, $V_{BIAS} = 5.5V$		0.02	<b>0.3</b>	%/V
$V_{BIAS}$ Line Regulation	$V_{BIAS} = 3.6V$ to 5.5V, $V_{IN} = V_{OUT} + 1V$		0.02	<b>0.3</b>	%/V
Load Regulation	$I_{OUT} = 100\mu A$ to 300mA		0.4	<b>1.0</b>	%
Dropout Voltage	$I_{OUT} = 150mA$		40	<b>100</b>	mV
	$I_{OUT} = 300mA$		85	<b>200</b>	mV
Ground Pin Current $V_{IN1}, V_{IN2}$	$V_{EN1} = \text{High}$ ; $V_{EN2} = \text{Low}$ ; $I_{OUT1} = 100\mu A$ to 300mA		7	<b>12</b>	$\mu A$
	$V_{EN1} = \text{Low}$ ; $V_{EN2} = \text{High}$ ; $I_{OUT2} = 100\mu A$ to 300mA		7	<b>12</b>	$\mu A$
Ground Pin Current $V_{BIAS}$	$I_{OUT1} = I_{OUT2} = 100\mu A$ to 300mA		30	<b>46</b>	$\mu A$
Ground Pin Current in Shutdown	$V_{EN} \leq 0.2V$		0.01	1.0	$\mu A$
$V_{IN}$ Ripple Rejection	$f = 1kHz$ ; $C_{OUT} = 1.0\mu F$ ; $C_{BYP} = 0.01\mu F$		65		dB
	$f = 20kHz$ ; $C_{OUT} = 1.0\mu F$ ; $C_{BYP} = 0.01\mu F$		40		dB
Current Limit	$V_{OUT} = 0V$	350	550		mA
Output Voltage Noise	$C_{OUT} = 1\mu F$ , $C_{BYP} = 0.01\mu F$ , 10Hz to 100kHz		30		$\mu V_{RMS}$
<b>Enable</b>					
Enable Input Voltage	Logic Low			<b>0.2</b>	V
	Logic High	<b>1.2</b>			V
Enable Input Current	$V_{IL} \leq 0.2V$		0.02	<b>1</b>	$\mu A$
	$V_{IH} \geq 1.2V$		0.2	<b>1</b>	$\mu A$
Turn-on Time	$C_{OUT} = 1\mu F$ ; $C_{BYP} = 0.01\mu F$		150	<b>300</b>	$\mu s$
<b>POR2 Output</b>					
$V_{TH}$	Low Threshold, % of $V_{OUT2}$ (Flag ON)	88			%
	High Threshold, % of $V_{OUT2}$ (Flag OFF)			98	%
$V_{OL}$	POR2 Output Logic Low Voltage; $I_L = 250\mu A$		0.02	0.1	V
$I_{POR2}$	Flag Leakage Current, Flag OFF	-1	0.01	+1	$\mu A$

Parameter	Condition	Min	Typ	Max	Units
<b>CSET2 INPUT</b>					
CSET2 Pin Current Source	$V_{CSET2} = 0V$	<b>0.8</b>	1.4	<b>2</b>	$\mu A$
CSET2 Pin Threshold Voltage	POR2 = High	1.212	1.25	1.288	V

**Notes:**

1. Exceeding the absolute maximum rating may damage the device.
2. The device is not guaranteed to function outside its operating rating.
3. The maximum allowable power dissipation of any  $T_A$  (ambient temperature) is  $P_{D(max)} = (T_{J(max)} - T_A) / \theta_{JA}$ . Exceeding the maximum allowable power dissipation will result in excessive die temperature, and the regulator will go into thermal shutdown.
4. Devices are ESD sensitive. Handling precautions recommended. Human body model, 1.5k $\Omega$  in series with 100pF.
5. Specification for packaged product only.

# Typical Characteristics

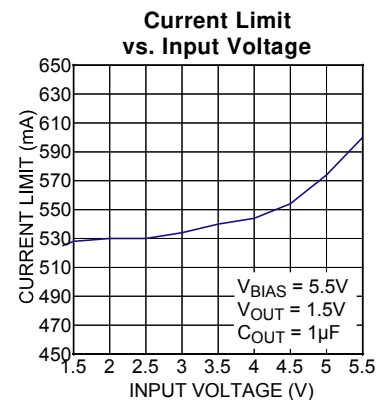
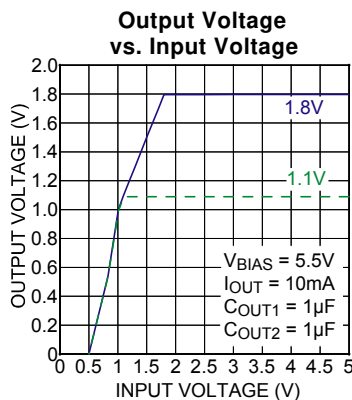
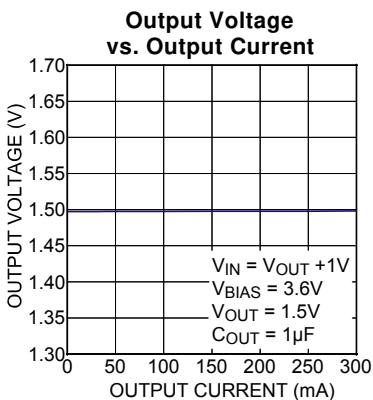
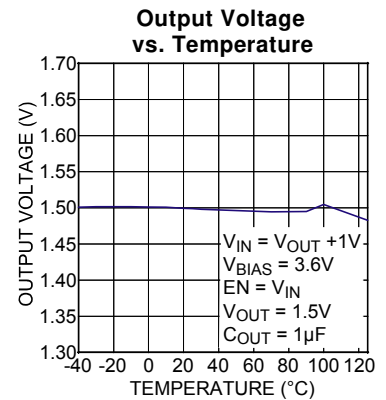
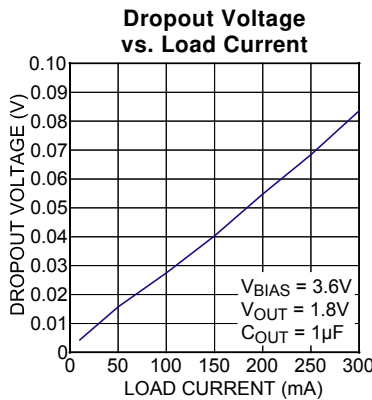
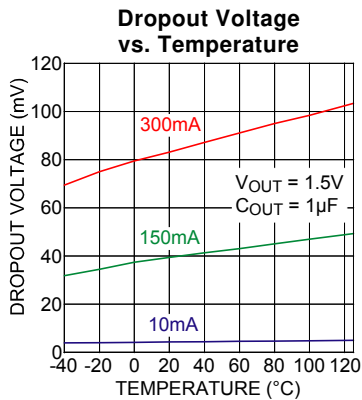
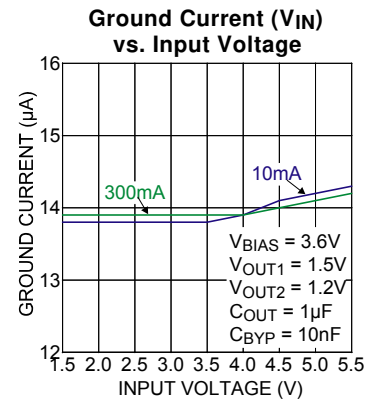
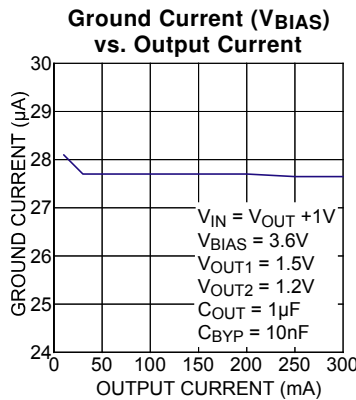
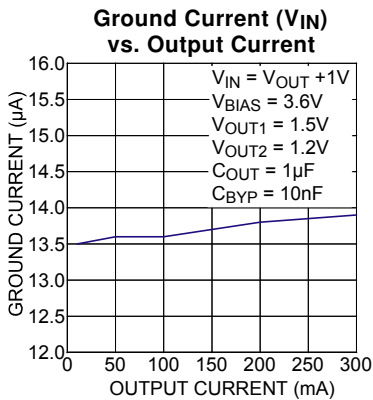
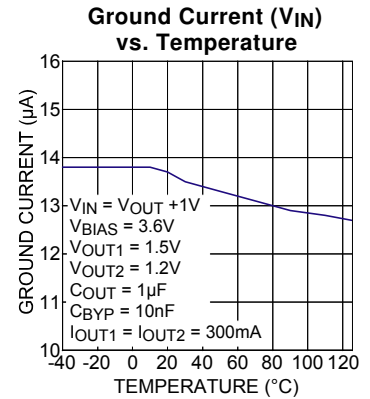
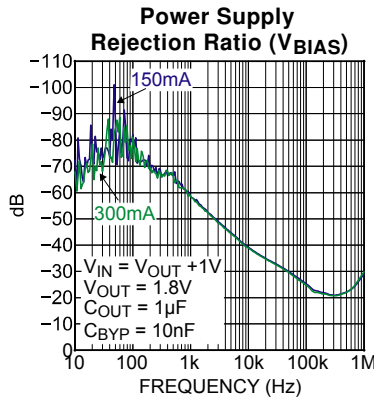
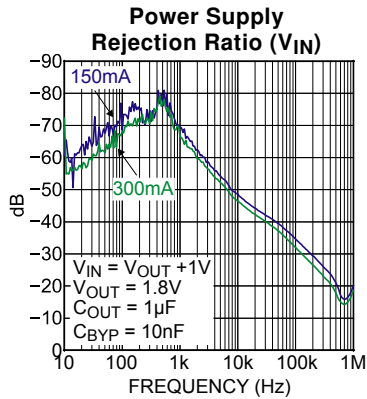

### Typical Characteristics (continued)

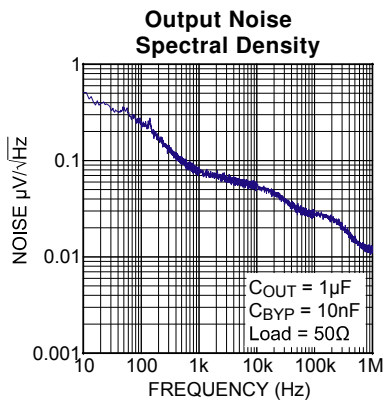

## Functional Characteristics

Line Transient ( $V_{IN}$ )

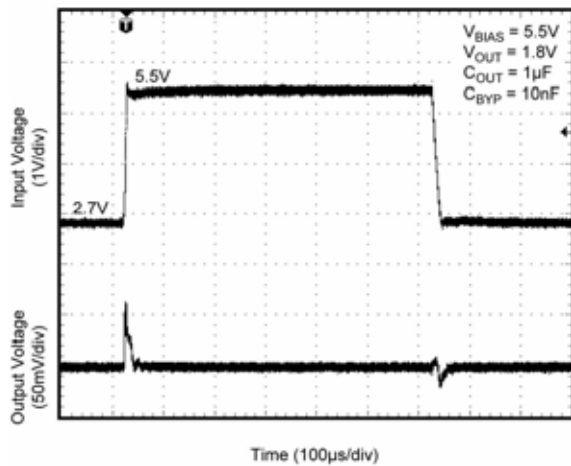

Line Transient ( $V_{BIAS}$ )

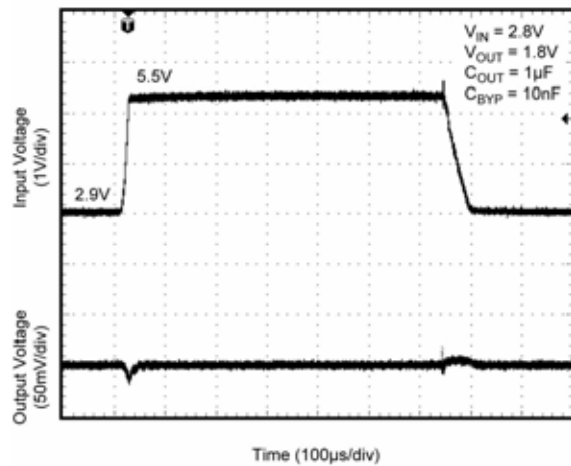

Load Transient

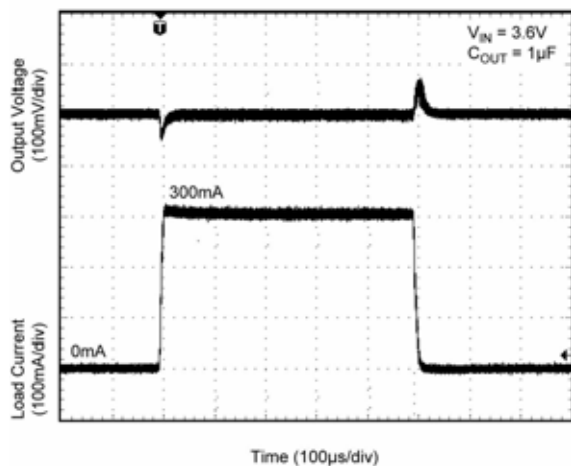

Load Transient

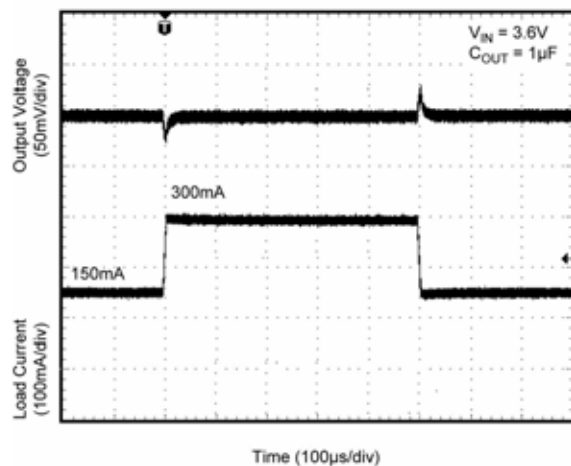

Power-On Reset (Turn-On)

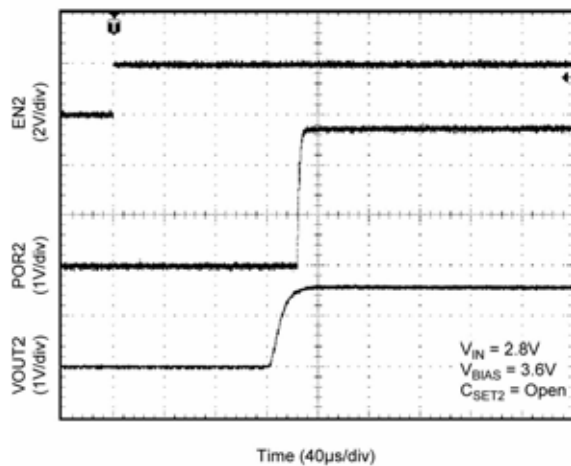

Power-On Reset (Turn-Off)

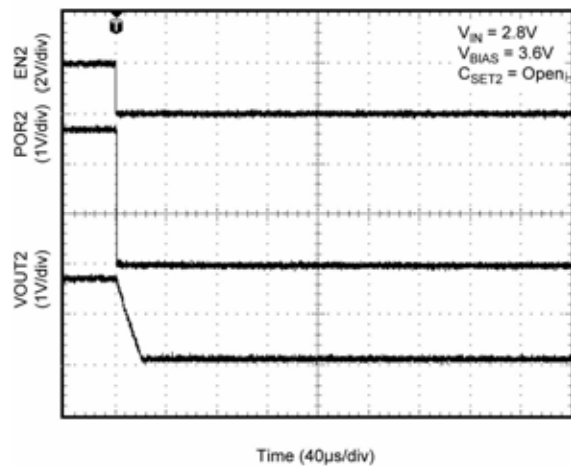

## Functional Characteristics (continued)

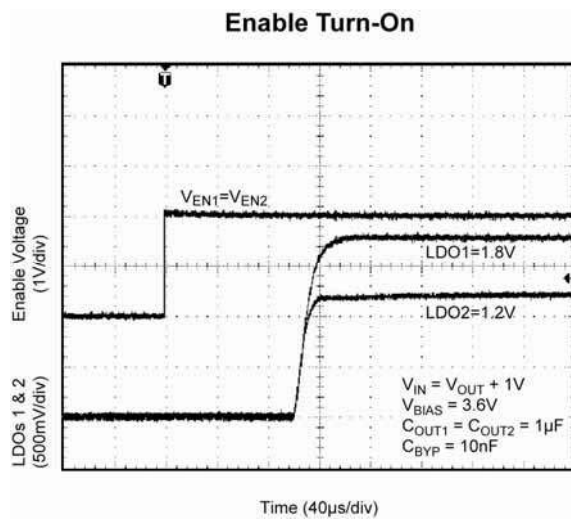



### Functional Diagram

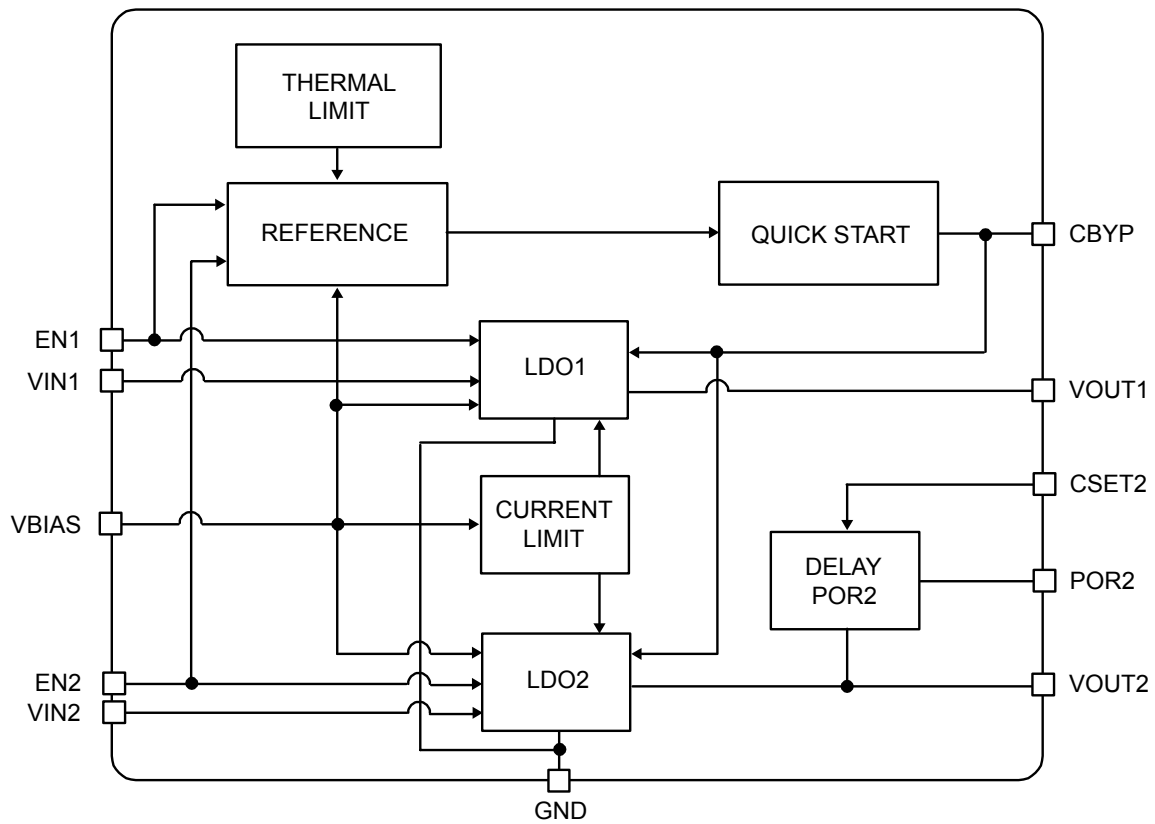

MIC5314 Block Diagram

## Application Information

The MIC5314 is a high performance, dual low input voltage, ultra-low dropout regulator designed for applications requiring very fast transient response. The MIC5314 utilizes two input supplies ( $V_{IN}$  and  $V_{BIAS}$ ), significantly reducing the dropout voltage.

The MIC5314 regulator is fully protected from damage due to fault conditions, offering linear current limiting and thermal shutdown.

### Bias Supply Voltage

$V_{BIAS}$ , requiring relatively light current, provides power to the control portion of the MIC5314. Bypassing on the bias pin is recommended to improve performance of the regulator during line and load transients. A  $1\mu\text{F}$  ceramic capacitor from  $V_{BIAS}$ -to-ground is recommended to help reduce the high frequency noise from being injected into the control circuitry.

### Input Supply Voltage

$V_{IN1}$  and  $V_{IN2}$ , provide the supply to power the LDOs independently. The minimum input voltage is 1.7V allowing conversion from low voltage supplies. The low input voltage provides high efficiency by reducing the input to output voltage step which minimizes the regulator power loss.

### Input Capacitor

The MIC5314 is a high-performance, high bandwidth device. Therefore, it requires a well-bypassed input supply for optimal performance. A  $1\mu\text{F}$  capacitor is required from the input-to-ground to provide stability. Low-ESR ceramic capacitors provide optimal performance at a minimum of space. Additional high-frequency capacitors, such as small-valued NPO dielectric-type capacitors, help filter out high-frequency noise and are good practice in any RF-based circuit. X5R or X7R dielectrics are recommended for the input capacitor. Y5V dielectrics lose most of their capacitance over temperature and are therefore, not recommended.

### Output Capacitor

The MIC5314 requires an output capacitor of  $1\mu\text{F}$  or greater to maintain stability. The design is optimized for use with low-ESR ceramic chip capacitors. High ESR capacitors may cause high frequency oscillation. The output capacitor can be increased, but performance has been optimized for a  $1\mu\text{F}$  ceramic output capacitor and does not improve significantly with larger capacitance.

X7R/X5R dielectric-type ceramic capacitors are recommended because of their temperature performance. X7R-type capacitors change capacitance by 15% over their operating temperature range and are the most stable type of ceramic capacitors. Z5U and Y5V dielectric capacitors change value by as much as

50% and 60%, respectively, over their operating temperature ranges. To use a ceramic chip capacitor with Y5V dielectric, the value must be much higher than an X7R ceramic capacitor to ensure the same minimum capacitance over the equivalent operating temperature range.

### Bypass Capacitor

A capacitor can be placed from the bypass pin-to-ground to reduce the output voltage noise. The capacitor bypasses the internal reference. A  $0.01\mu\text{F}$  capacitor is recommended for applications that require low-noise outputs. The bypass capacitor can be increased, further reducing noise and improving PSRR. Turn-on time increases slightly with respect to the bypass capacitance. A unique, quick-start circuit allows the MIC5314 to drive a large capacitor on the bypass pin without significantly slowing turn-on time.

### No-Load Stability

Unlike many other voltage regulators, the MIC5314 will remain stable and in regulation with no load. This is especially important in CMOS RAM keep-alive applications.

### Enable/Shutdown

The MIC5314 is provided with dual active-high enable pins that allow each regulator to be disabled independently. Forcing the enable pin low disables the regulator and sends it into a “zero” off-mode-current state. In this state, current consumed by the regulator goes nearly to zero. Forcing the enable pin high enables the output voltage. The active-high enable pin uses CMOS technology and the enable pin cannot be left floating; a floating enable pin may cause an indeterminate state on the output.

### Power On Reset

The second regulator (LDO2) provides a Power On Reset (POR2) status pin. This pin is an open drain output. When LDO2 is enabled an active low POR2 indicates an under voltage condition on  $V_{OUT2}$ .

The POR2 status signal can be programmed for a delay ( $1\text{sec}/\mu\text{F}$ ) by adding a capacitor from the  $C_{SET2}$  pin to ground. Zero delay is added by leaving the  $C_{SET2}$  pin open circuit.

### Thermal Considerations

The MIC5314 is designed to provide 300mA of continuous current for both outputs in a very small package. Maximum ambient operating temperature can be calculated based upon the output current and the voltage drop across the part. Given that the input voltage is 1.8V, the output voltage is 1.5V for  $V_{OUT1}$ , 1.0V for  $V_{OUT2}$  and the output current = 300mA for each output. The actual power dissipation of the regulator circuit can

be determined using the equation:

$$P_D = (V_{IN} - V_{OUT1}) I_{OUT1} + (V_{IN} - V_{OUT2}) I_{OUT2} + V_{BIAS} I_{GND}$$

Because this device is CMOS and the ground current is typically  $<100\mu\text{A}$  over the load range, the power dissipation contributed by the ground current is  $< 1\%$  and can be ignored for this calculation.

$$P_D = (1.8\text{V} - 1.5\text{V}) \times 300\text{mA} + (1.8\text{V} - 1.0\text{V}) \times 300\text{mA}$$

$$P_D = 0.33\text{W}$$

To determine the maximum ambient operating temperature of the package, use the junction-to-ambient thermal resistance of the device and the following basic equation:

$$P_{D(\text{MAX})} = \left( \frac{T_{J(\text{MAX})} - T_A}{\theta_{JA}} \right)$$

$T_{J(\text{max})} = 125^\circ\text{C}$ , the maximum junction temperature of the die. The junction-to-ambient thermal resistance for the minimum footprint, is  $\theta_{JA} = 70^\circ\text{C/W}$ .

Substituting  $P_D$  for  $P_{D(\text{max})}$  and solving for the ambient operating temperature will give the maximum operating conditions for the regulator circuit.

The maximum power dissipation must not be exceeded for proper operation.

For example, when operating the MIC5314-FCYMT at an input voltage of 1.8V and 300mA, loads at each output with a minimum footprint layout, the maximum ambient operating temperature  $T_A$  can be determined as follows:

$$0.33\text{W} = (125^\circ\text{C} - T_A)/(70^\circ\text{C/W})$$

$$T_A = 101.9^\circ\text{C}$$

For a full discussion of heat sinking and thermal effects on voltage regulators, refer to the "Regulator Thermals" section of *Micrel's Designing with Low-Dropout Voltage Regulators* handbook. This information can be found on Micrel's website at:

[http://www.micrel.com/\\_PDF/other/LDOBk\\_ds.pdf](http://www.micrel.com/_PDF/other/LDOBk_ds.pdf)

### MIC5314 Typical Application Circuit

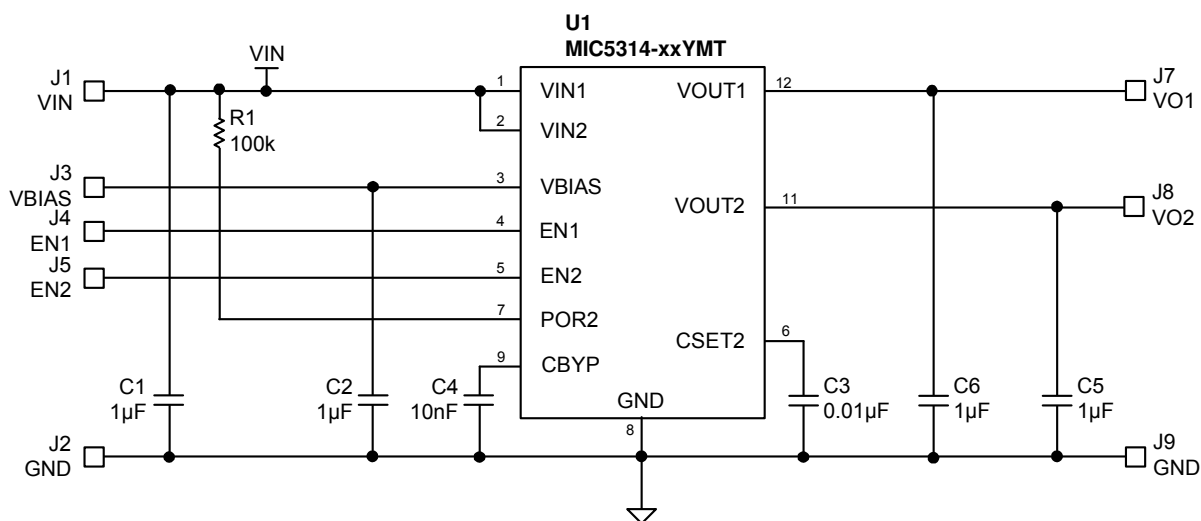

### Bill of Materials

Item	Part Number	Manufacturer	Description	Qty
C1, C2, C5, C6	C1608X5R1A105K	TDK <sup>(1)</sup>	Capacitor, 1µF Ceramic, 10V, X5R, Size 0603	4
C3	VJ0603Y104KXACW1BC	Vishay <sup>(2)</sup>	Capacitor, 0.1µF, 50V, X7R, Size 0603	1
C4	VJ0603Y103KXACW1BC	Vishay <sup>(2)</sup>	Capacitor, 0.01µF, 50V, X7R, Size 0603	1
R1	CRCW0603100KFKEA	Vishay <sup>(2)</sup>	Resistor, 100kΩ, 1%, 1/16W, Size 0603	1
<b>U1</b>	<b>MIC5314-xxYMT</b>	<b>Micrel<sup>(3)</sup></b>	<b>Low Voltage Dual 300mA LDO with POR</b>	<b>1</b>

**Notes:**

1. TDK: [www.tdk.com](http://www.tdk.com)
2. Vishay: [www.vishay.com](http://www.vishay.com)
3. Micrel, Inc.: [www.micrel.com](http://www.micrel.com)

### PCB Layout Recommendations

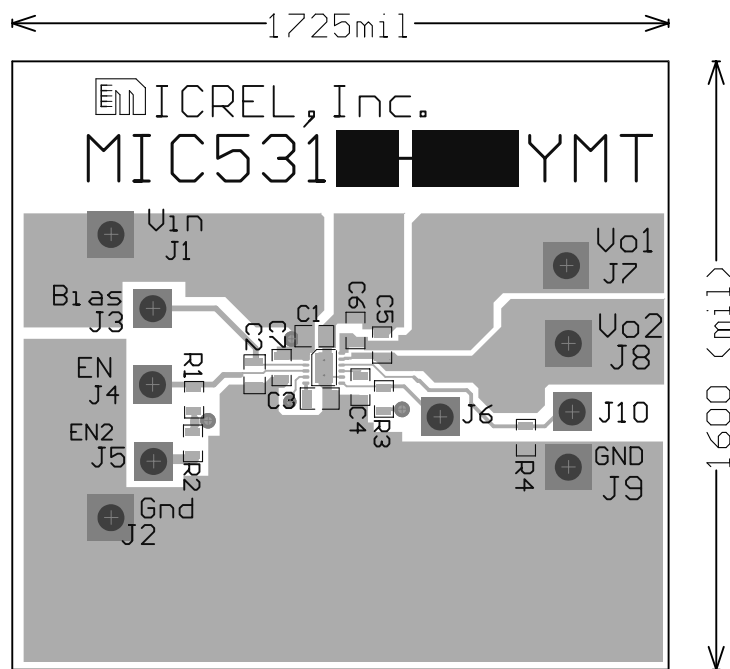

Top Layer

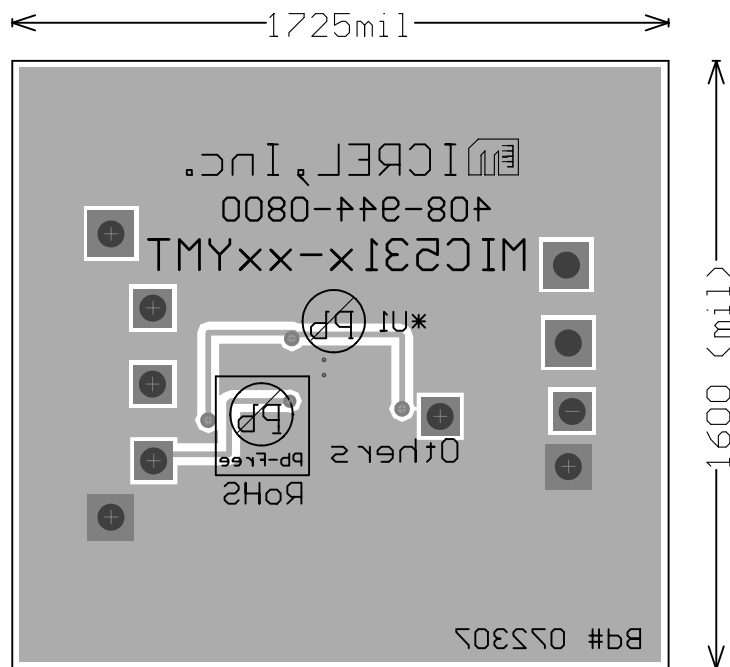

Bottom Layer

# Package Information

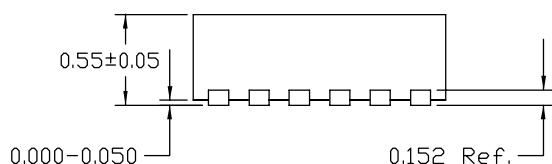
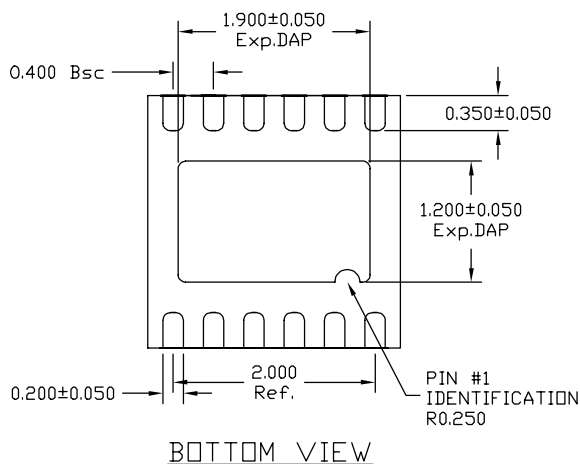
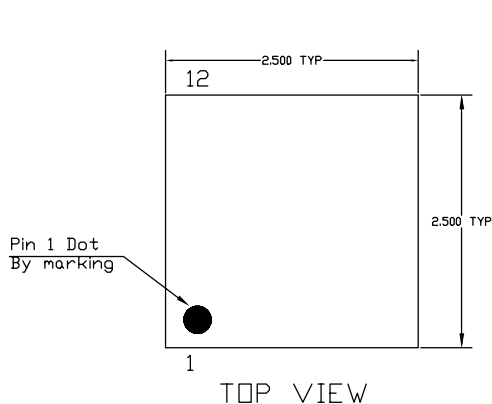

**NOTES :**

1. ALL DIMENSIONS ARE IN MILLIMETERS.
2. MAX. PACKAGE WARPAGE IS 0.05 mm.
3. MAXIMUM ALLOWABLE BURRS IS 0.076 mm IN ALL DIRECTIONS.
4. PIN #1 ID ON TOP WILL BE LASER MARKED.

**12-Pin 2.5mm × 2.5mm Thin MLF® (MT)**

**MICREL, INC. 2180 FORTUNE DRIVE SAN JOSE, CA 95131 USA**  
 TEL +1 (408) 944-0800 FAX +1 (408) 474-1000 WEB <http://www.micrel.com>

The information furnished by Micrel in this data sheet is believed to be accurate and reliable. However, no responsibility is assumed by Micrel for its use. Micrel reserves the right to change circuitry and specifications at any time without notification to the customer.

Micrel Products are not designed or authorized for use as components in life support appliances, devices or systems where malfunction of a product can reasonably be expected to result in personal injury. Life support devices or systems are devices or systems that (a) are intended for surgical implant into the body or (b) support or sustain life, and whose failure to perform can be reasonably expected to result in a significant injury to the user. A Purchaser's use or sale of Micrel Products for use in life support appliances, devices or systems is a Purchaser's own risk and Purchaser agrees to fully indemnify Micrel for any damages resulting from such use or sale.

© 2008 Micrel, Incorporated.