



*The Power of Linking Together*

**ABRACON  
CORPORATION**

**Abracon PTM  
Introduction to ACA Series  
Ceramic Chip Antennas**

**Crystals  
Oscillators  
Filters  
Precision Timing  
Inductors**



# ACA Series Ceramic Chip Antennas

## Purpose

To introduce ACA Series, Ceramic Chip Antennas.

## Objective

Present the advantage, performance and applications of Abracon ACA Series.

## Content

21 pages

## Learning Time

25 minutes

Welcome to Abracon's ACA Series; Ceramic Chip Antenna Training Module. This training session will provide an overview of the key features and benefits; as well as, discuss the applications of this product series.

Crystals  
Oscillators  
Filters  
Precision Timing  
Inductors

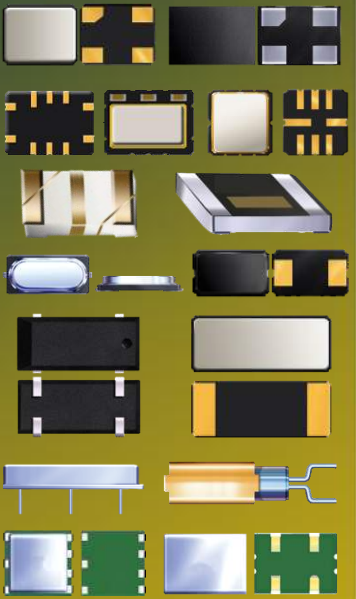



# Product - ACA Series Ceramic Chip Antennas

## Abracon ACA Series-Part Numbering

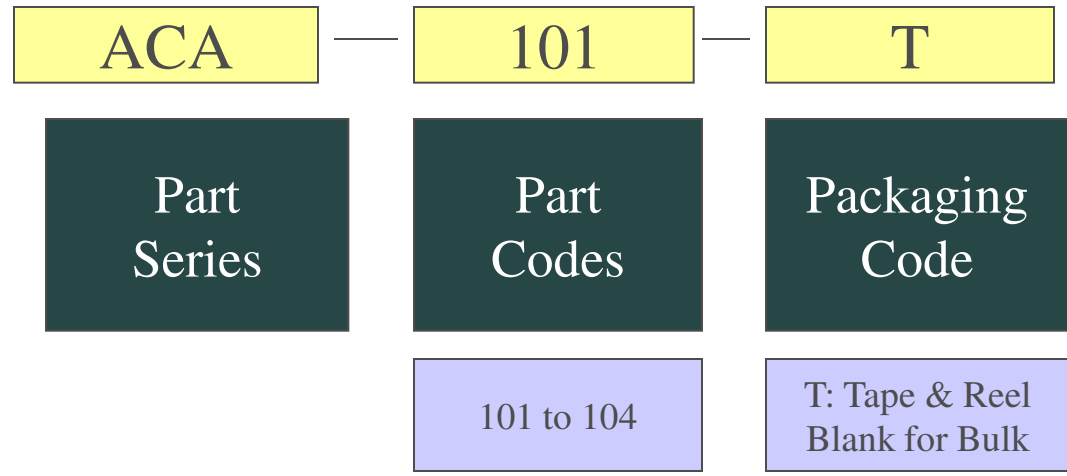
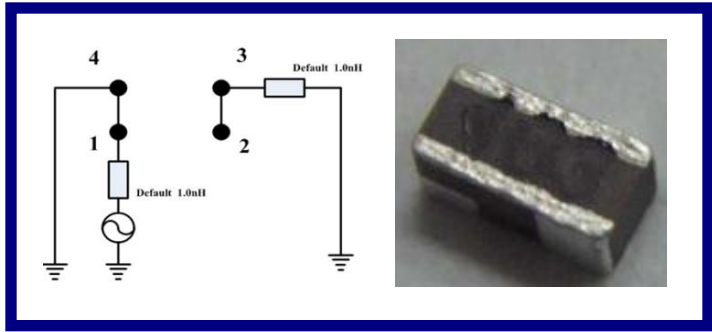

The ACA Series offers a range of Chip Antennas identified by part codes starting 101 to 104.

Crystals  
Oscillators  
Filters  
Precision Timing  
Inductors

**ABRACON**  
CORPORATION



# Abracon ACA Series - Part Numbering & Descriptions

Part No	Description / Band	Frequency Band (MHz)	Size
<b>ACA-101-T</b>	Chip Antenna - WLAN / Bluetooth / Zigbee	2400 ~ 2485	4 x 2 x 1.2 mm
<b>ACA-102-T</b>	Chip Antenna WLAN / Bluetooth	2400 ~ 2485	2 x 1.2 x 1.0 mm
<b>ACA-103-T</b>	Dual Band Chip Antenna – WiFi / Bluetooth & WiFi	2400 ~ 2485 & 5150 ~ 5825	5 x 2 x 1.2 mm
<b>ACA-104-T</b>	Chip Antennas – GPS	1570 ~ 1580	3 x 1.5 x 1.2 mm

Crystals  
Oscillators  
Filters  
Precision Timing  
Inductors



The ACA Series covers Chip Antennas covering 2.45GHz Bluetooth / WiFi and GPS



# Introduction to Chip Antennas

- o An antenna (also known as an aerial) is a transducer that transmits or receives RF signals by converting electromagnetic radiation into electrical current, or vice versa.
- o Antennas can take many forms but this introduction will focus on Ceramic Chip Antenna.
- o Radio communications have become ubiquitous across everyone's daily life's, e.g. WiFi, Cellular Mobile Phones or Machine-to-machine (MCM) devices
- o These devices communicate by transmitting and receiving RF signal bands between 700MHz to 5.4GHz.
- o These radio links require high quality radio interface to support the communication links.
- o To meet selectivity requirements ANTENNA are critical to. the design



Antennas are a critical design elements that provide the effective launch of the Tx EMF wave and reception of the Rx signal from free space, providing the initial selectivity of the radio system.

**Crystals  
Oscillators  
Filters  
Precision Timing  
Inductors**

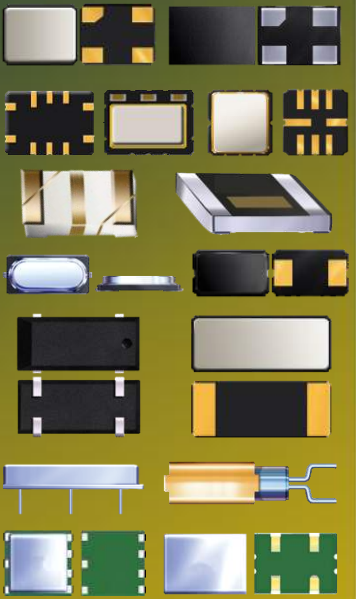



# Example of Block Diagram Bluetooth TCVR

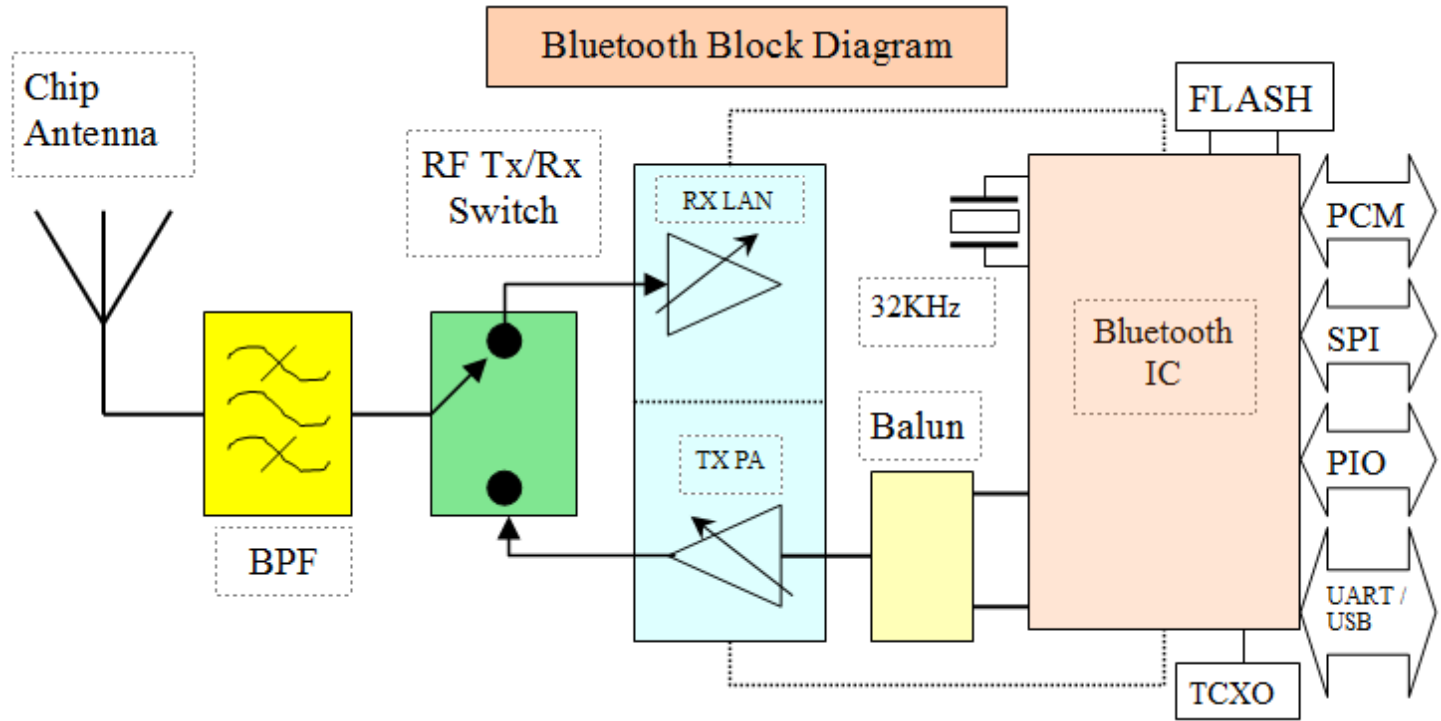

Block diagram shows application of **Chip Antenna** in the 2.45GHz Bluetooth TCVR. See also use of BPF, Balun, TCXO and 32.768KHz Xtal in Bluetooth module.

In this Bluetooth example, the 2.45GHz antenna provides the transmission and reception of signals. In many handheld solution the choice of antenna will be a ceramic chip type. Abracon also provides other BOM elements for Bluetooth boards or modules; typically SAW BPF, as well as 32.768KHz Crystals and TCXO used to clock the radio IC are needed.

Crystals  
Oscillators  
Filters  
Precision Timing  
Inductors

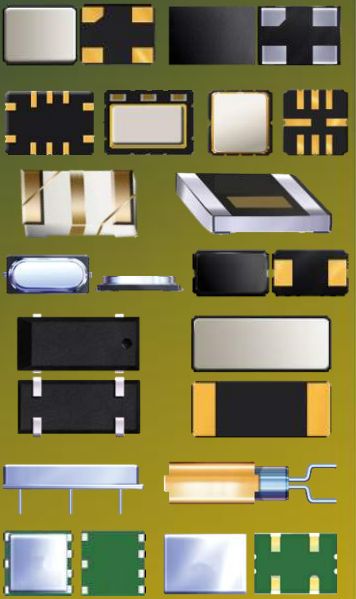



# Ceramic Chip Antenna Technology

## What are Chip Antennas?

Chip antennas come in various sizes and are often seen as small ceramic blocks with minimal metal artwork and SM pads into which the signal is launched. The ACA series are constructed from solid high dielectric ceramic material.

**Chip Antenna** summarizes a group of Ceramic Dielectric Antenna of varied design types including:

- Ceramic Monopole
- Ceramic Loop
- Ceramic Helix
- Ceramic IFA (Inverted F Antenna)

Monopole types

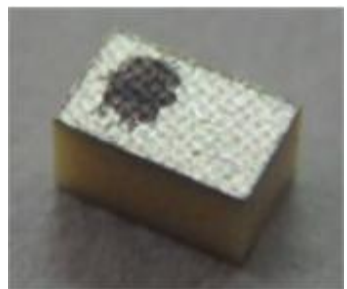

Helix type



Chip Antennas are small ceramic blocks onto which silver patterns are printed to create an antenna structure. The term Chip Antenna covers a range of types of antenna offering different gains and layout considerations.

Crystals  
Oscillators  
Filters  
Precision Timing  
Inductors





# Ceramic Chip Antenna Technology

## Size of Chip Antenna

Chip Antenna vary with the frequency band, the dielectric ( $\epsilon_r$ ) used, and their design architecture.

Integrated solutions like mobile phones have driven the size of these down (within the boundaries of technology), so that we see 2.4GHz parts as small as 2 x 1.2 x 1.0 mm (ACA-102-T)

## Types and trade-offs.

Some Chip Antenna designs like Monopole and Loop types require non-ground PCB “keep out areas” for mounting; while other types like the Inverted F type require a ground area under the antenna by design.

Available space is often a key consideration for antenna type. The “ ceramic loop type” is the smallest but needs added space for traces and keep out areas.

Designers need to refer to the specific layout, and reproduced accurately if antenna performance is to be met.

The size of the Chip Antenna is determined by the dielectric constant ( $\epsilon_r$ ) of the Ceramic used, the radio frequency concerned, and the type or design of antenna. Designers need to consider trade-offs of board space required when picking an antenna.

Crystals  
Oscillators  
Filters  
Precision Timing  
Inductors

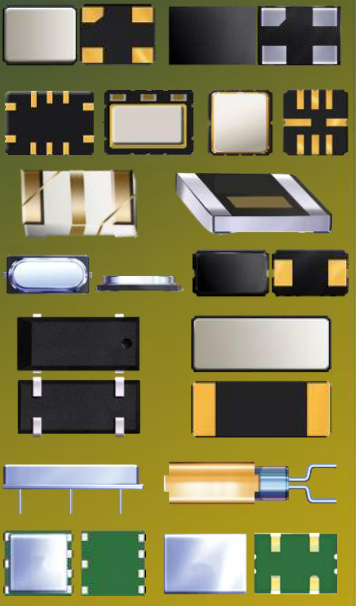





# Key Features of Chip Antennas

- o Use of high dielectric ceramics materials allows compact design.
- o Single or multi-band, across a range of bands, making them ideal for multi-band applications like Mobile Phone / Tablets.
- o They offer low profile, light weight, small form factor suitable for compact applications.
- o Excellent gain and directivity performance relative to their size.
- o Ease of matching during application development.
- o Better SAR response than PCB traces .
- o Improved isolation allowing multiple antenna applications.
- o Their omni-directional radiation highly suitable for mobile communications.

Chip Antennas offer a range of advantages to designers who have restricted space or cannot afford an external antenna. Key features included compact design, excellent efficiency, better SAR score (Specific Absorption Rate) compared to other alternatives, and an omni-directional radiation pattern (like a sphere), ideal for mobile phone applications.

**Crystals**  
**Oscillators**  
**Filters**  
**Precision Timing**  
**Inductors**

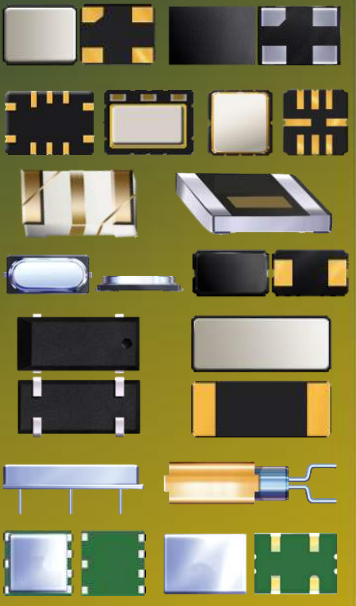



# Ceramic Chip vs. PCB Trace Antennas

- o Designers have the option to add their antenna as a printed trace on the PCB, this adds no additional BOM cost, but will increase the pcb size, and may have other issues as well.
- o A trace antenna manufactured within the printed circuit board (PCB) is often the first type of interface considered based on cost
- o Ceramic Antenna are often good or even better alternative to trace antenna solutions
- o The table in the next slide demonstrates the design attributes to sell Chip Antenna, when compared to cheaper PCB trace solutions.

Designers are constantly faced with reduction of BOM cost. Antennas embedded in the PCB offer a cost saving solution, but these are rarely the smallest or quickest design solutions on offer. Chip antenna offer a number of advantages, and this and the following slide cover the trade offs designers face.

**Crystals**  
**Oscillators**  
**Filters**  
**Precision Timing**  
**Inductors**

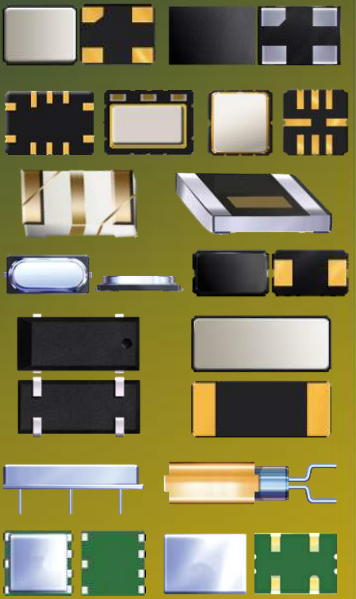



# Ceramic Chip vs. PCB Trace Antennas

Comparative Features	Chip Antenna	PCB Trace
Lower manufacturing costs	✗	✓
Simple PCB structure	✗	✓
Larger Bandwidth	✗	✓
Embedded design	✗	✓
PCB area for Antenna	✓	✗
Close objects cause detune	✓	✗
Antenna performance and tuning affected by PCB design	✓	✗
Ease of tuning antenna	✓	✗
Design Iteration, improved time to market	✓	✗
Ease of design changes	✓	✗
Flexible testing and tuning options	✓	✗
Rework Costs to PCB	✓	✗

Crystals  
Oscillators  
Filters  
Precision Timing  
Inductors

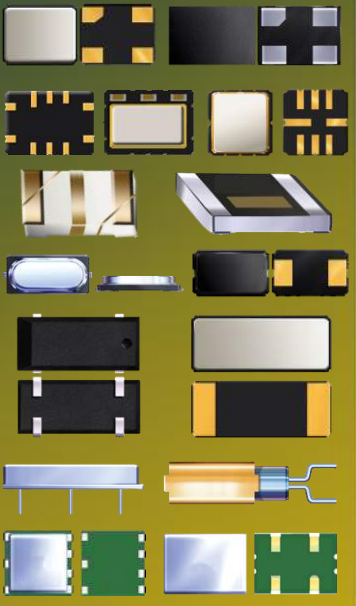



Crystals  
Oscillators  
Filters  
Precision Timing  
Inductors

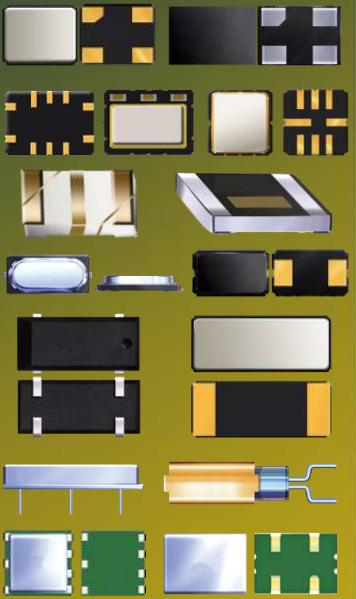

# Antenna Radiation Patterns

## 3D Radiation Pattern

2445.000MHz

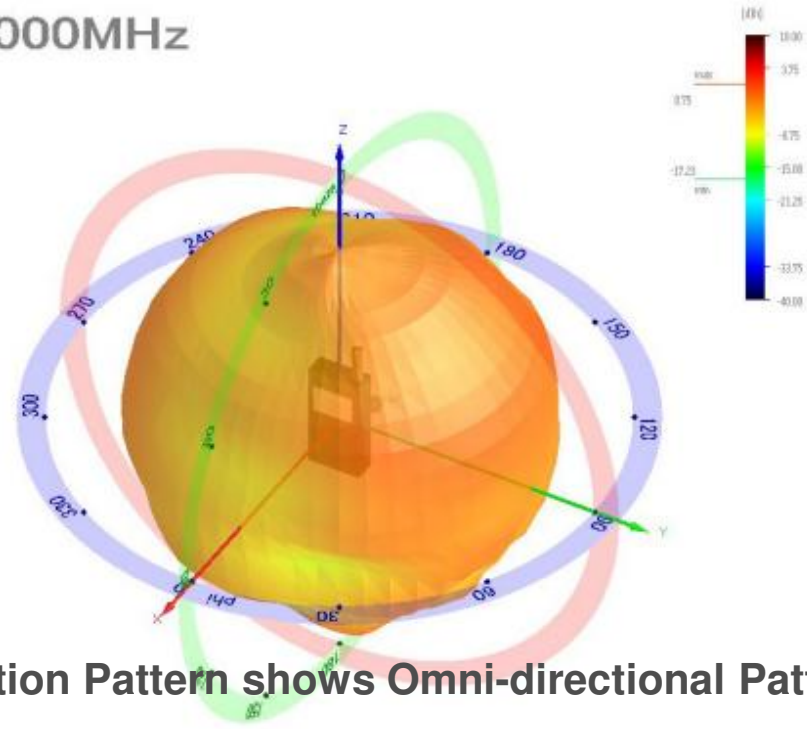

3D Radiation Pattern shows Omni-directional Pattern

No.	Freq.	Pwr Sum	Eff[%]	Avg[dB]	Peak[dB]	θ[deg]	φ[deg]	H(θ-90)	Peak[dB]	φ[deg]	BW[deg]	E1(φ-9)	Peak[dB]	θ[deg]	BW[deg]	E2(φ-90)	Peak[dB]	θ[deg]	BW[deg]
1	2400.000	32.82	-4.84	-0.42	135.00	195.00	-4.91	-2.19	150.00	130.57	-5.76	-2.53	-135.00	40.19	-4.43	-1.55	30.00	101.04	
2	2425.000	34.77	-4.59	-0.33	135.00	195.00	-4.33	-2.14	210.00	135.20	-5.50	-2.31	-135.00	38.97	-4.20	-1.66	30.00	115.60	
3	2445.000	44.89	-3.48	0.60	135.00	195.00	-3.02	-0.71	210.00	132.38	-4.54	-1.32	-135.00	42.79	-3.18	-0.66	60.00	123.04	
4	2465.000	31.90	-4.96	-1.03	135.00	195.00	-4.41	-1.97	210.00	54.47	-6.02	-2.65	-135.00	46.22	-4.77	-2.21	60.00	118.75	
5	2485.000	30.51	-5.16	-1.28	135.00	195.00	-4.60	-2.17	210.00	47.55	-6.09	-3.03	-135.00	48.37	-5.07	-2.58	60.00	115.82	

The diagram shows the omni-directional 3D radiation patter of a typical Chip Antenna. This provides 360 degree coverage, and is suited to handheld devices.



# Typical Antenna PCB Matching

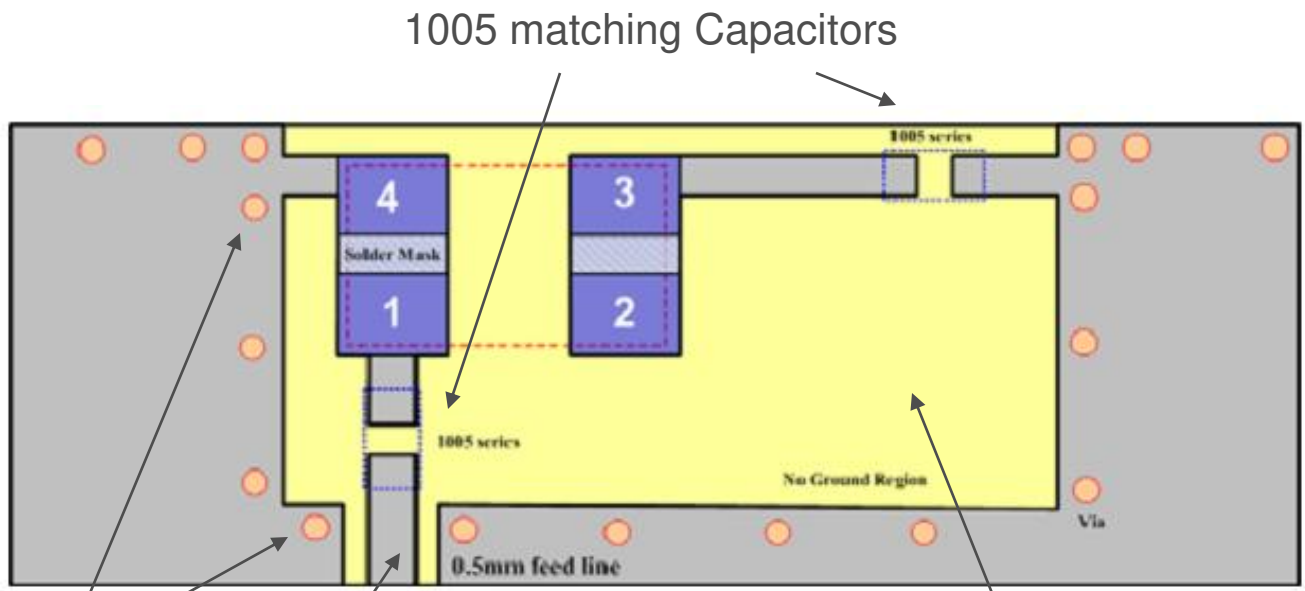

Vias

0.5mm Feed line

No Ground Area.  
Keep Out area

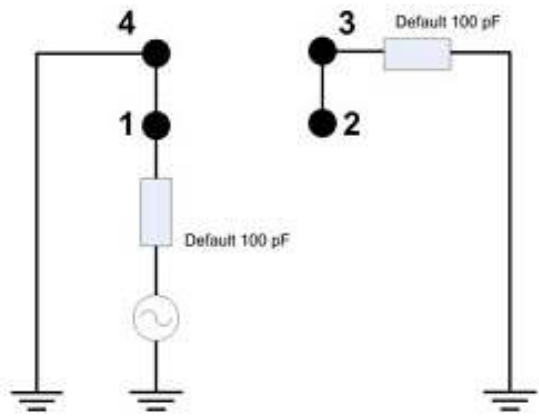

< Default Condition Equivalent Circuit >

**Please see data sheets for specific part layout**

The diagram shows a typical pcb layout for a chip antenna, with matching components. Typically these will need a no-ground region / keep out area, as this is critical for antenna performance.

Crystals  
Oscillators  
Filters  
Precision Timing  
Inductors

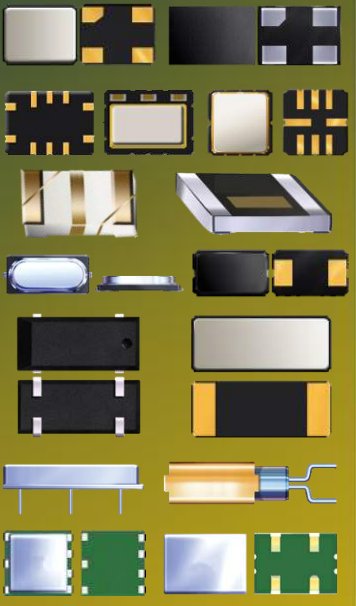



# What RF Applications need Chip Antenna

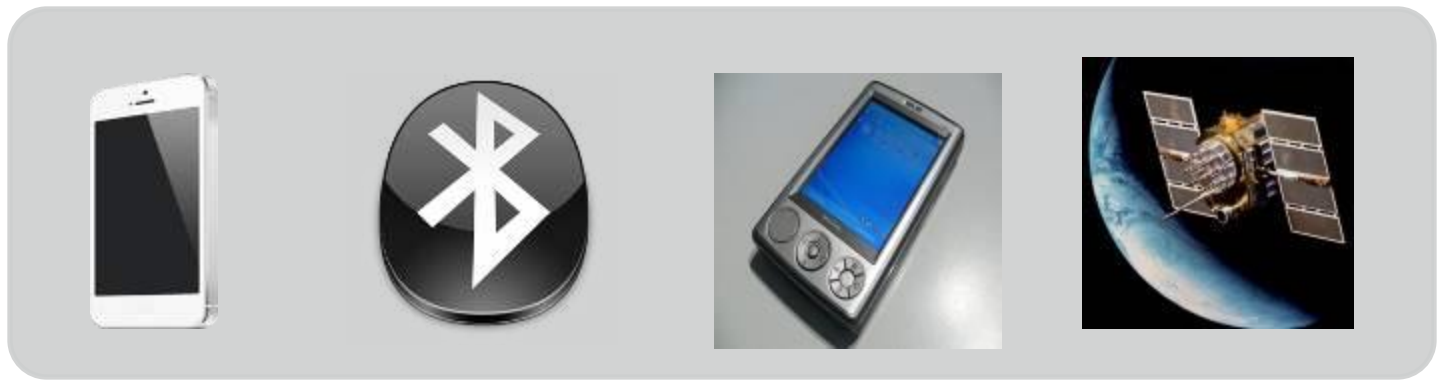

Mobile Phones  
Tablets  
Mobile Gaming

Bluetooth

WLAN  
802.11a/b/  
g/j/n  
Dual Band

GPS

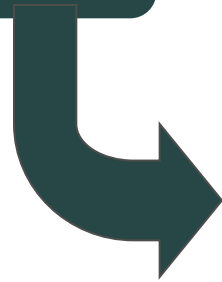

ACA-101-T &  
ACA-102-T

ACA-103-T  
Dual Band

ACA-104-T

Bluetooth / WiFi at 2.45GHz and 5.5GHz and GPS offer many applications for Chip Antennas.

**Crystals**  
**Oscillators**  
**Filters**  
**Precision Timing**  
**Inductors**

**ABRACON CORPORATION**



# Where Chip Antennas are Utilized

## **Bluetooth Applications:**

- o Bluetooth exists in many products, such as telephones, tablets, media players, and gaming like Lego Mindstorms NXT, Playstation 3, PS Vita, Nintendo Wii, and HD Headsets, Modems and watches:
- o Bluetooth Headsets / Intercoms
- o Bluetooth Audio Headsets
- o Keyboards / Mouse
- o Games Consoles / Controllers
- o Wireless bridge between two Industrial Ethernet (e.g. PROFINET) networks.
- o Short range transmission of health sensor data from medical devices to mobile phone, or dedicated “Telehealth” devices.
- o Personal security applications – tags

**Crystals  
Oscillators  
Filters  
Precision Timing  
Inductors**

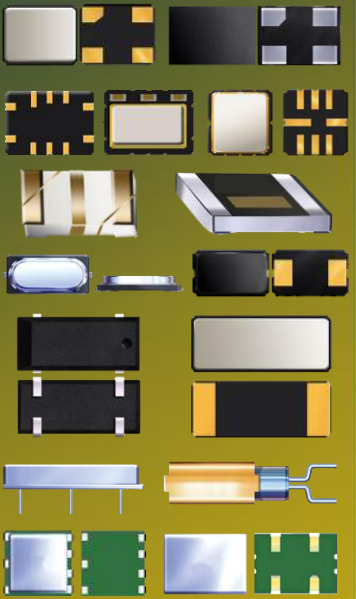

The Bluetooth technology offers a wide selection of companies involved with Bluetooth enabled devices.



# Where Chip Antennas are Utilized

- o **WiFi Applications: The “Internet of Things”**
  - o The number of Internet-connected devices in the world in 2011 was estimated at 20 billion by 2020 this is expected to rise to 50 billion devices.
  - o Networking
  - o Consumer Electronics
  - o Computing and Peripherals
  - o Headsets
  - o Automotive and Transport
  - o Health & Fitness
  - o Smart Energy
  - o Industrial Communications

**Crystals  
Oscillators  
Filters  
Precision Timing  
Inductors**

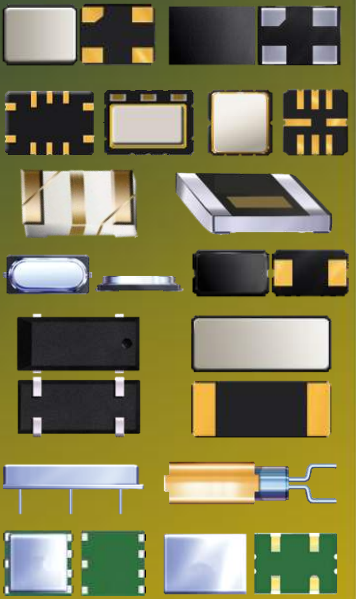

The “Internet of Things” offers an increasing wide application of connected or controlled WiFi solutions. A wide selection of WiFi certified product exist, and provide many applications for Chip Antennas.





# Where Chip Antennas are Utilized

- o **GPS Applications:**
  - o GPS devices have different antenna types dependant on their application. GPS Chip antenna often find applications in smaller and handheld devices.
  - o Navigation devices, Garmin / TomTom etc
    - o Vehicles
    - o Cycling
    - o Walking
  - o Survey Equipment
  - o Commercial fleet management
  - o Car Trackers (anti-theft)
    - o Tracking of valuable cargoes, and covert tracking of suspects.
  - o Agricultural control (Farm vehicles)
  - o Scientific applications of GPS
    - o Environmental and atmospheric monitoring,
    - o Animal behaviour studies,
    - o Botanical specimen location

**Crystals  
Oscillators  
Filters  
Precision Timing  
Inductors**

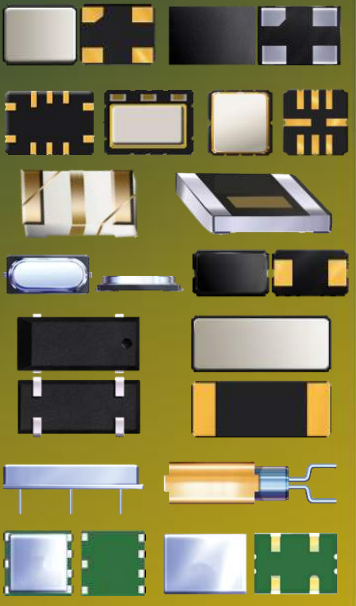

Many GPS enabled devices offer application for Chip Antennas, especially smaller commercial and handheld solutions, where size and cost are drivers.



# Cost Effective and Fast lead time

P/N	Size	VSWR Max	Gain Peak / Avg (dBi)	Qty/Reel	Std. L/T
ACA-101-T (2.45GHz)	4x2x1.2mm	3.0 max (typ 2.5)	1.09 / -3.49	1K	8Wks
ACA-102-T (2.45GHz)	2x1.2x1mm	2.6 max (typ 1.6)	0.6 / -3.48	1K	8Wks
ACA-103-T (2.45 & 5.2GHz)	5x2x1.2mm	3.0 max (typ 2.5)	-1.37 / -4.53	1K	8Wks
ACA-104-T (1575MHz)	3x1.5x1.2 mm	3.0 max (typ 2.0)	0.03 / -2.98	1K	8Wks

Crystals  
Oscillators  
Filters  
Precision Timing  
Inductors

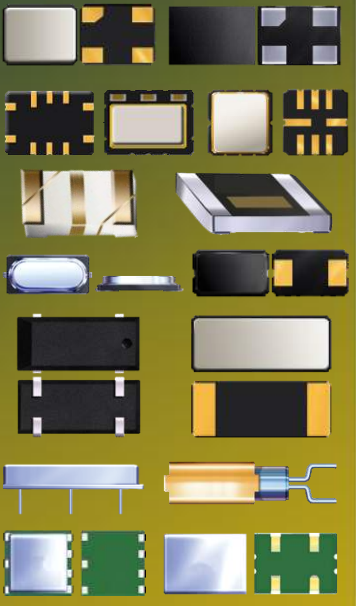

Website Datasheet: <http://www.abracon.com/products.php?search=chipAntenna>

The table summarizes the cost effective Chip Antenna solutions offered by Abracon along with the technology advantages of size, efficiency and gain offered here.

Thank You for your Kind Attention

-----

Abracon Ceramic Chip Antennas