



EV3120-J-00A

1.2A, 1.1MHz Synchronous Boost Converter Evaluation Board

DESCRIPTION

The EV3120-J-00A is a Boost converter evaluation board for the MP3120DJ, a synchronous, 1.1MHz fixed frequency, current mode step-up converter with output to input disconnect.

It can startup from an input voltage as low as 0.85V and provides inrush current limiting as well as output short circuit protection.

The output voltage also can be regulated when $V_{IN} > V_{OUT}$, and the P-channel MOS is no longer act as a low impedance switch.

The EV3120-J-00A regulates the output voltage up to 3.3V from single cell AA battery without the uses of an external Schottky diode.

The MP3120DJ is offered in a TSOT23-6 package.

ELECTRICAL SPECIFICATION

Parameter	Symbol	Value	Units
Input Voltage	V_{IN}	0.85-5	V
Output Voltage	V_{OUT}	3.3	V

FEATURES

- Up to 96% Efficiency
- True Output Load Disconnect
- Inrush Current Limiting and Internal Soft-Start
- Low Voltage Start-Up: 0.85V
- Internal Synchronous Rectifier
- Current Mode Control with Internal Compensation
- Short-Circuit Protection
- 1.1MHz Fixed Frequency Switching
- Input Range: 0.85V to 5V
- Output Range: 2.5V to 5V
- Tiny External Components
- Small 6-lead ThinSOT Package

APPLICATION

- Single-cell, Two-cell and Three-cell Alkaline, NiCd or NiMH or single-cell Li Battery Consumer Products
- MP3 Players
- Wireless Mouse
- Audio Recorders

All MPS parts are lead-free and adhere to the RoHS directive. For MPS green status, please visit MPS website under Products, Quality Assurance page. "MPS" and "The Future of Analog IC Technology" are registered trademarks of Monolithic Power Systems, Inc.

EV3120-J-00A EVALUATION BOARD



Board Number	MPS IC Number
EV3120-J-00A	MP3120DJ

Efficiency vs. Output Current

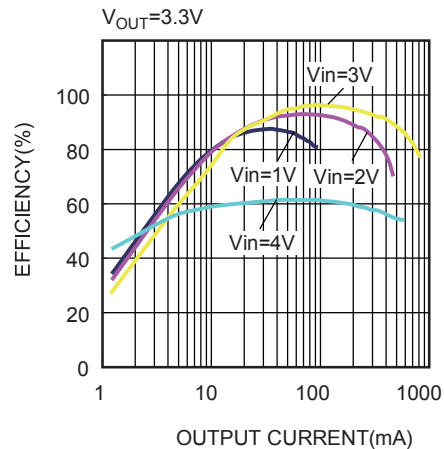

EVALUATION BOARD SCHEMATIC

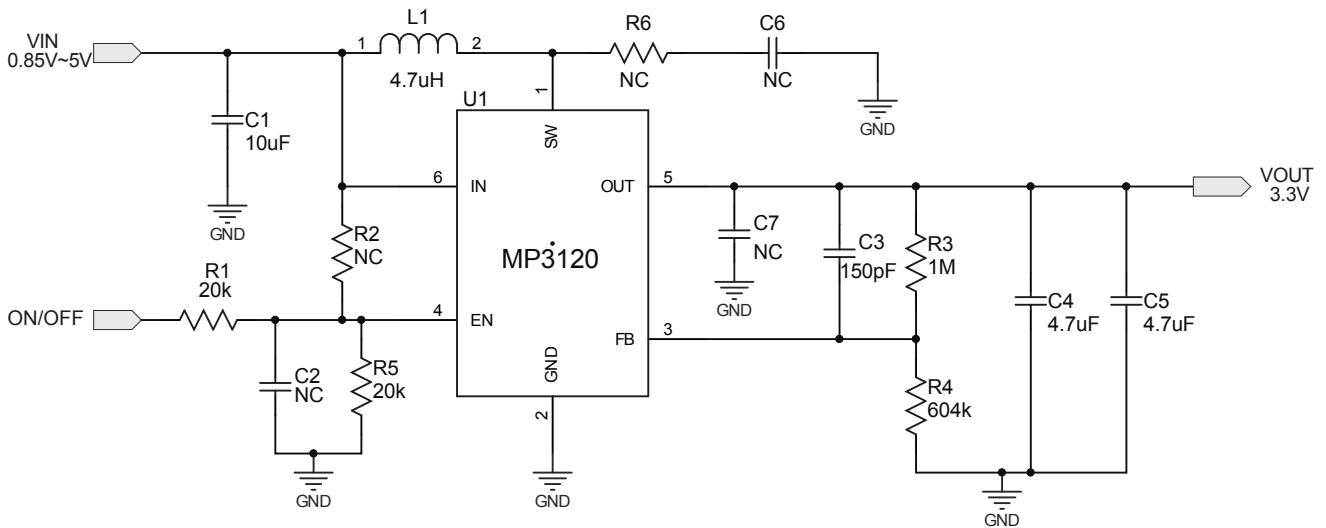

EV3120-J-00A BILL OF MATERIALS

Qty	Ref	Value	Description	Package	Manufacturer	Manufacturer P/N
1	U1	MP3120	Boost converter	TSOT23-6	MPS	MP3120DJ
1	L1	4.7µH	R _{DC} =19.5mΩ, 7A inductor,	SMD	Würth	744311470
1	C1	10µF	Ceramic Capacitor,25V,X7R	1206	TDK	C3216X7R1E106K
1	C2	NC				
1	C3	150pF	Ceramic Capacitor,50V,X7R	0603	TDK	C1608X7R1C151K
2	C4,C5	4.7µF	Ceramic Capacitor,16V,X7R	1206	TDK	C3216X7R1C475K
2	C6,C7	NC				
2	R1, R5	20k	Resistor 5%	0603	Yageo	RC0603JR-0720KL
2	R2,R6	NC				
1	R3	1M	Resistor 1%	0603	Yageo	RC0603FR-071ML
1	R4	604k	Resistor 1%	0603	Yageo	RC0603FR-07604KL

TEST RESULT

C1=10μF, C2=C3=4.7μF, L1=4.7μH, TA=25°C, unless otherwise noted.

Steady Waveform
VIN=2.5V, VOUT=3.3V, IOUT=0mA

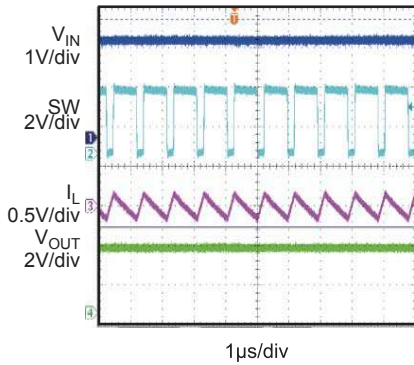

Steady Waveform
VIN=2.5V, VOUT=3.3V, IOUT=500mA

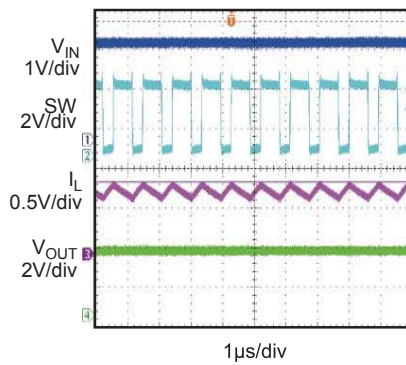

Steady Waveform
VIN=4.4V, VOUT=3.3V, IOUT=0mA

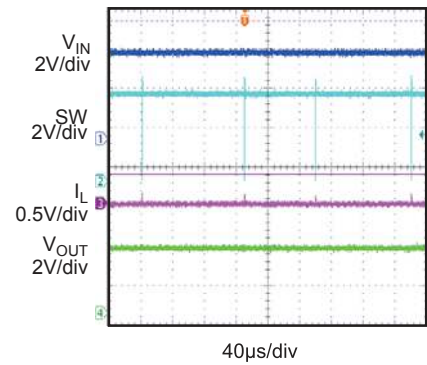

Steady Waveform
VIN=4.4V, VOUT=3.3V, IOUT=500mA

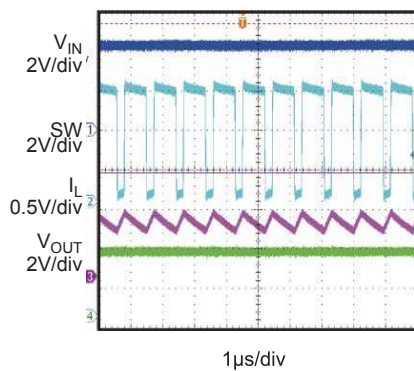

Load Transient Waveform
VIN=2.5V, VOUT=3.3V, IOUT=0mA to 200mA

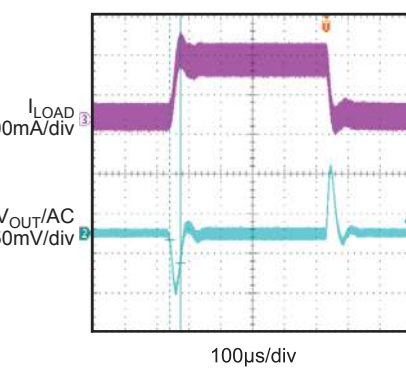

VIN Startup
VIN=2.5V, VOUT=3.3V, IOUT=500mA

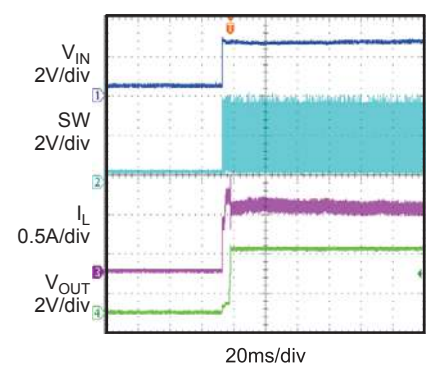

EN Startup
VIN=2.5V, VOUT=3.3V, IOUT=500mA

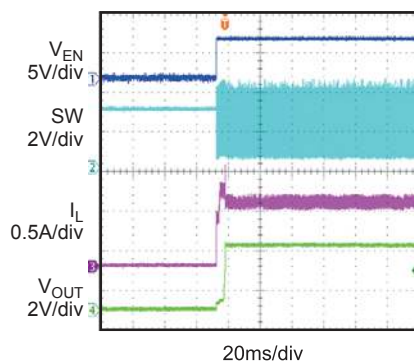

VIN Shut down
VIN=2.5V, VOUT=3.3V, IOUT=500mA

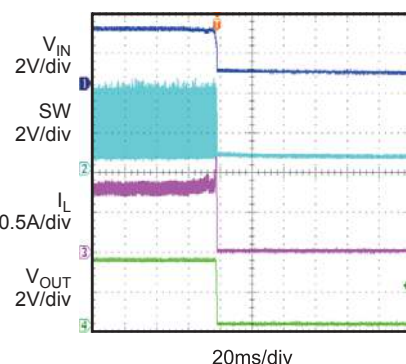

EN Shut down
VIN=2.5V, VOUT=3.3V, IOUT=500mA

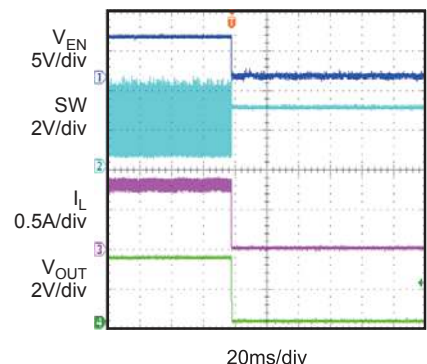

TEST RESULT

C1=10 μ F, C2=C3=4.7 μ F, L1=4.7 μ H, T_A=25°C, unless otherwise noted.

Short Circuit and Recovery

V_{IN}=3V

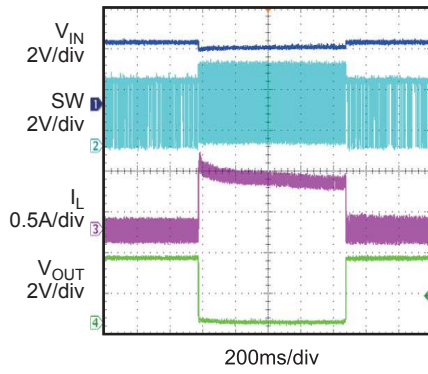

Short Circuit Steady Waveform

V_{IN}=3V

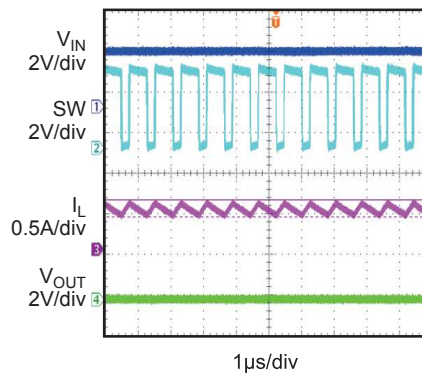

PRINTED CIRCUIT BOARD LAYOUT

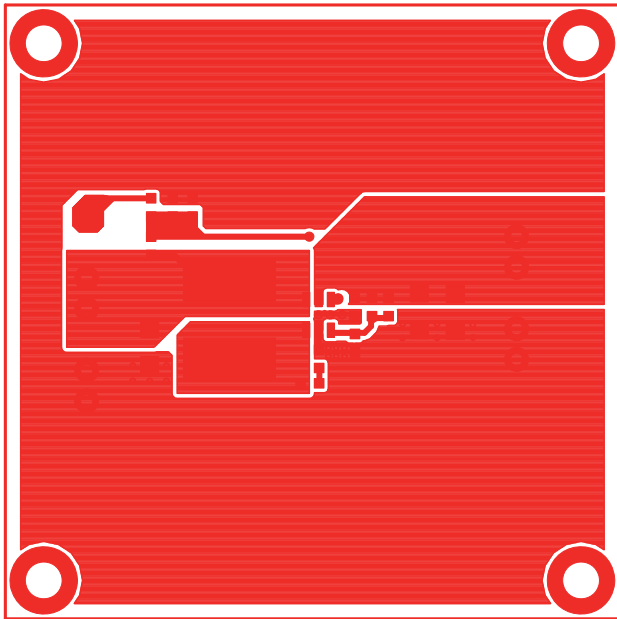

Figure1-Top layer

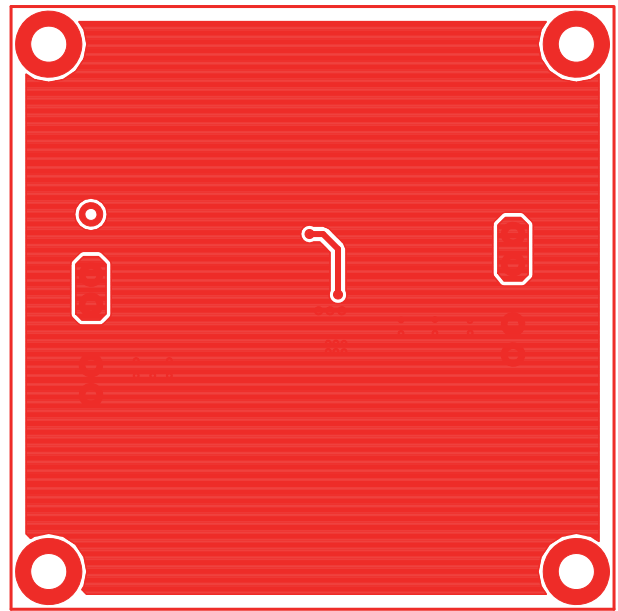

Figure2-Bottom Layer

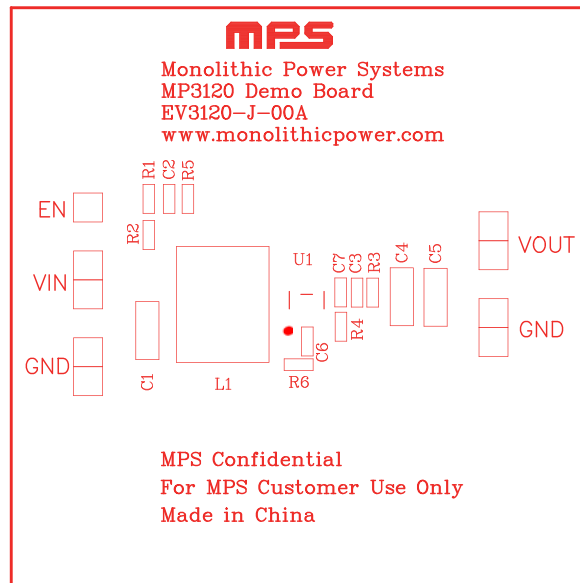

Figure3-Top Silk Layer

QUICK START GUIDE

The output voltage of this board is set to 3.3V. The board layout accommodates most commonly used inductors and output capacitors.

1. Preset power supply to $0.85V \leq V_{IN} \leq 5V$;
2. Turn off the power supply;
3. Connect power supply terminals to
Positive (+): VIN
Negative (-): GND
4. Connect Load to:
Positive (+): OUT
Negative (-): GND
5. Connect the EN to 5V power supply
Positive (+): EN
Negative (-): GND
6. Turn on the power supply.
7. The V_{OUT} of the EVB is set to 3.3V. If other output voltage is needed, adjust V_{OUT} with the formula:

$$V_{OUT} = V_{FB} \times \frac{R3 + R4}{R4}$$

Where $V_{FB}=1.21V$.

NOTICE: The information in this document is subject to change without notice. Users should warrant and guarantee that third party Intellectual Property rights are not infringed upon when integrating MPS products into any application. MPS will not assume any legal responsibility for any said applications.