



Crystal Clock Oscillator Specification

IQD Part No. + Packaging: LFSPX0018038Reel

Würth Part No. 831018038



Description

- Standard 7 x 5mm crystal oscillator in a ceramic package with a seam sealed metal lid, hermetically sealed.
- Model CFPS-73
- Model Issue number 13

Frequency Parameters

- Frequency 16.0MHz
- Frequency Stability $\pm 50.00\text{ppm}$
- Operating Temperature Range 0.00 to 70.00°C
- Ageing $\pm 3\text{ppm per year max}$

Electrical Parameters

- Supply Voltage 3.3V $\pm 10\%$
- Current Draw 7.000mA
- Note: parameters are referenced to 15pF load

Output Details

- Output Compatibility HCMOS
- Drive Capability 15pF std, 50pF max
- Rise and Fall Time 10.0ns max
- Duty Cycle 45/55

Output Control

- Standby Operation:
Logic '1' (>70% VS) to pad 1 enables oscillator output
Logic '0' (<30% VS) to pad 1 disables oscillator output; the oscillator output goes to the high impedance state
No connection to pad 1 enables oscillator output
Standby Current: 10 μ A max

Noise Parameters

- Phase Noise @125MHz (typical):
10Hz -54dBc
100Hz -92dBc
1kHz -130dBc
10kHz -149dBc
100kHz -159dBc
1MHz -163dBc
- RMS Phase Jitter @125MHz: 52fs typical

Environmental Parameters

- Shock: MIL-STD-202, Method 213, Condition E
- Vibration: MIL-STD-883, Method 2007, Condition A
- Storage Temperature Range: -55 to 125°C

Manufacturing Details

- RoHS Terminations NiAu
- RoHS Reflow Temp 260degC 10s

Compliance

- RoHS Status (2011/65/EU) Compliant
- REACH Status Compliant
- MSL Rating (JDEC-STD-033): Not Applicable



Outline (mm)

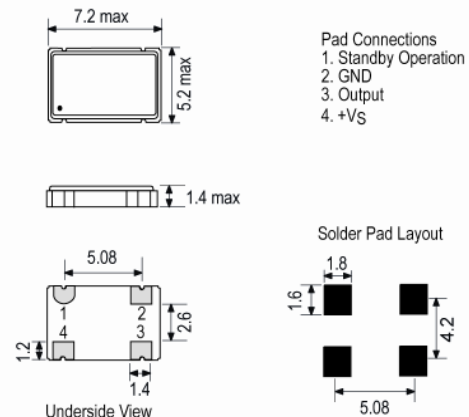

Test Circuit

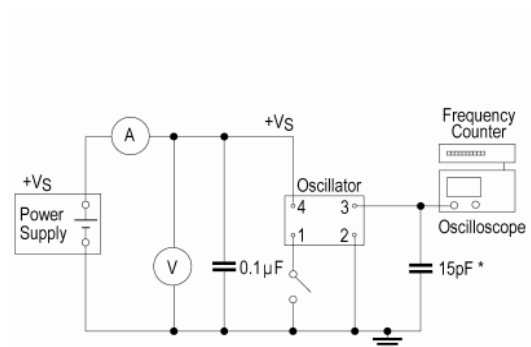

* Inclusive of jigging and equipment capacitance

CONTACT INFORMATION:

Würth Elektronik eiSos GmbH & Co. KG
Max-Eyth-Str. 1, 74638 Waldenburg, Germany
Tel: +49(0) 7942 945-0

Email: eiSos@we-online.de
Web: www.we-online.com



Crystal Clock Oscillator Specification

IQD Part No. + Packaging: LFSPX0018038Reel

Würth Part No. 831018038



Packaging Details

- Pack Style: Reel Tape & reel in accordance with EIA-481-D
Pack Size: 1,000
- Alternative packing option available

USEFUL LINKS

Toolbox:

www.we-online.com/toolbox

Product Catalog:

www.we-online.com/products

Wave Form

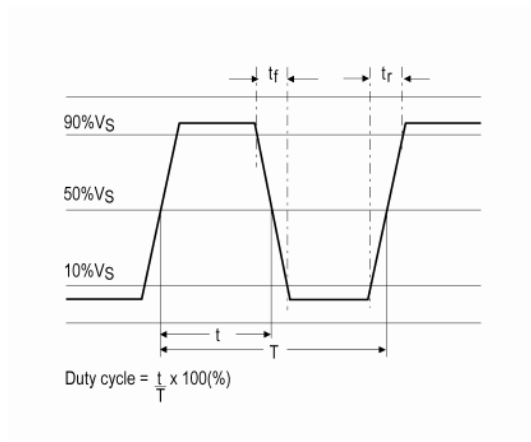

Phase Noise / Jitter

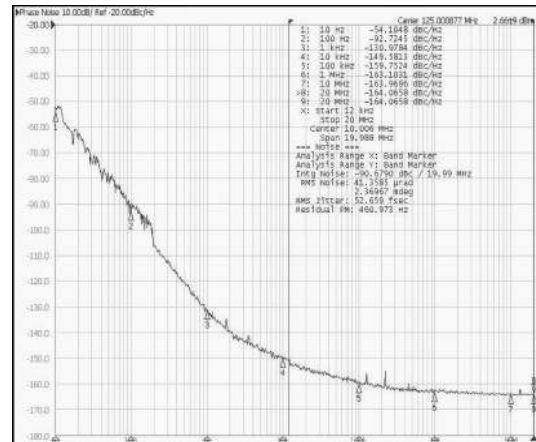

CONTACT INFORMATION:

Würth Elektronik eiSos GmbH & Co. KG
Max-Eyth-Str. 1, 74638 Waldenburg, Germany
Tel: +49(0) 7942 945-0

Email: eiSos@we-online.de
Web: www.we-online.com