

2 Watt

- International medical safety approvals
- Single & dual unregulated outputs
- Compact SMD package
- 4kV VAC reinforced isolation
- 1 x MOPP at 300 VAC
- 2 μ A patient leakage current
- Operating temperature -25 °C to +105 °C
- Full load to 60°C convection
- Tape & reel package available
- 3 year warranty

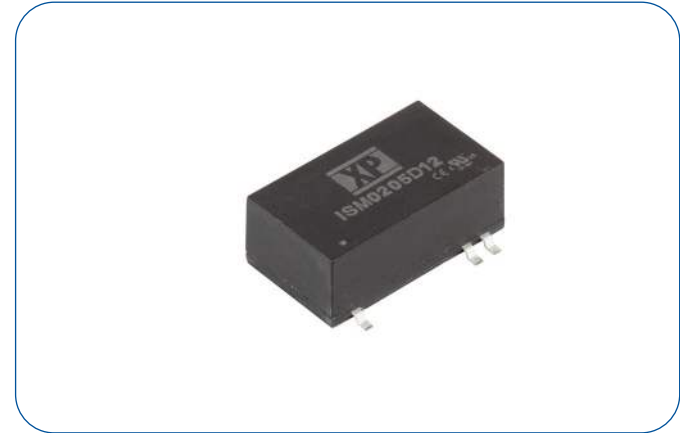

Dimensions:

ISM02:
0.94 x 0.71 x 0.36" (24.0 x 18.1 x 9.3 mm)

The ISM02 provides a compact cost effective SMD solution for healthcare applications providing 1 MOPP, 2 MOOP and IEC60601-1 compliance. Features include a high operating temperature, low leakage current, reinforced insulation and short circuit protection.

Models & Ratings

Input voltage	Output voltage	Output current		Input current ⁽¹⁾		Maximum capacitive load ⁽²⁾	Efficiency ⁽⁶⁾	Model number ⁽³⁾
		Max	Min	No load	Full load			
5V (4.5-5.5V)	5V	400 mA	8.0 mA	90 mA	605 mA	330 μ F	72%	ISM0205S05
	12V	165 mA	3.0 mA		600 mA	330 μ F	72%	ISM0205S12
	15V	133 mA	2.5 mA		605 mA	330 μ F	72%	ISM0205S15
	± 12 V	± 83 mA	± 1.5 mA		555 mA	± 100 μ F	72%	ISM0205D12
	± 15 V	± 66 mA	± 1.0 mA		540 mA	± 100 μ F	73%	ISM0205D15
12V (10.8-13.2V)	5V	400 mA	8.0 mA	40 mA	255 mA	330 μ F	70%	ISM0212S05
	12V	165 mA	3.0 mA		250 mA	330 μ F	72%	ISM0212S12
	15V	133 mA	2.5 mA		250 mA	330 μ F	72%	ISM0212S15
	± 12 V	± 83 mA	± 1.5 mA		225 mA	± 100 μ F	74%	ISM0212D12
	± 15 V	± 66 mA	± 1.0 mA		220 mA	± 100 μ F	75%	ISM0212D15
24V (21.6-26.4V)	5V	400 mA	8.0 mA	30 mA	125 mA	330 μ F	68%	ISM0224S05
	12V	165 mA	3.0 mA		125 mA	330 μ F	68%	ISM0224S12
	15V	133 mA	2.5 mA		125 mA	330 μ F	68%	ISM0224S15
	± 12 V	± 83 mA	± 1.5 mA		110 mA	± 100 μ F	74%	ISM0224D12
	± 15 V	± 66 mA	± 1.0 mA		110 mA	± 100 μ F	75%	ISM0224D15

Notes

1. Input currents measured at nominal input voltage.
2. Maximum capacitive load is per output.
3. For optional water washable version add suffix '-P'.

4. Add suffix '-TR' for tape and reel. MOQ 200 pcs.
5. Standard tube quantity 10 pcs.
6. Measured at maximum load.

Input

Characteristic	Minimum	Typical	Maximum	Units	Notes & Conditions
Input Voltage Range	4.5		5.5	VDC	5 V nominal
	10.8		13.2		12 V nominal
	21.6		26.4		24 V nominal
Input Filter	Internal Pi type filter				
Input Surge			9	VDC for 1 s	5 V nominal
			18		12 V models
			30		24 V models

Output

Characteristic	Minimum	Typical	Maximum	Units	Notes & Conditions
Output Voltage	5		30	VDC	See Models and Ratings table
Initial Set Accuracy		±2.0	±4.0	%	
Output Voltage Balance		±0.1	±1.0	%	For dual output with balanced loads
Minimum Load				A	See Models and Ratings table
Line Regulation		±1.2	±1.5	%	
Load Regulation			10	%	From 20% to 100% load. 5V output version is 12% max
Cross Regulation			±5.0	%	On dual output models when one load is varied between 25% and 100% and other is fixed at 100%
Transient Response		3	5	% deviation	Recovery within 1% in less than 250 µs for a 25% load change.
Ripple & Noise			150	mV pk-pk	20 MHz bandwidth. Measured using 0.47 µF ceramic capacitor.
Short Circuit Protection			0.5	s	With auto recovery
Maximum Capacitive Load					See Models and Ratings table
Temperature Coefficient			0.02	%/°C	

General

Characteristic	Minimum	Typical	Maximum	Units	Notes & Conditions
Efficiency		72		%	See Models and Ratings table
Isolation: Input to Output	4000			VAC	60 s, reinforced isolation at 300 VAC, 1 x MOPP/2 x MOOP
	6000			VDC	1 s
Leakage Current			2	µA	240 VAC, 60 Hz
Isolation Resistance	10 ⁹			Ω	At 500 VDC
Isolation Capacitance		15	20	pF	
Switching Frequency	50	80	100	kHz	
Power Density			12.2	W/in ³	
Mean Time Between Failure		2		MHrs	MIL-HDBK-217F, +25 °C GB
Lead-Free Reflow Solder Process	IPC/JEDEC J-STD-020D.1				
Case Material	Non conductive black plastic. UL94V-0 rated. Not suitable for water washing.				
Pin Material	Solder-coated phosphor bronze				
Weight		0.01 (3.75)		lb (g)	
Moisture Sensitivity Level	Level 2				IPC/JEDEC J-STD-020D.1

Environmental

Characteristic	Minimum	Typical	Maximum	Units	Notes & Conditions
Operating Temperature	-40		+105	°C	See derating curve
Storage Temperature	-50		+125	°C	
Case Temperature			+105	°C	
Humidity			95	%RH	Non-condensing
Cooling					Natural convection

Safety Approvals

Safety Agency	Safety Standard	Notes & Conditions
CB Medical	IEC60601-1	
UL Medical	ANSI AMMI ES60601-1	
EN Medical	EN60601-1	
UL ITE	UL/cUL60950-1, UL/cUL62368-1	
CE	Meets all applicable directives	
UKCA	Meets all applicable legislation	

EMC: Emissions

Phenomenon	Standard	Test Level	Notes & Conditions
Conducted	EN55011	Class A	See Application Notes

EMC: Immunity

Phenomenon	Standard	Test Level	Criteria	Notes & Conditions
ESD	EN61000-4-2	±15 kV air discharge, ±8 kV contact	A	
Radiated	EN61000-4-3	10 V/m	A	
EFT/Burst	EN61000-4-4	±2 kV	A	
Surge	EN61000-4-5	±1 kV	A	
Conducted	EN61000-4-6	6kV rms	A	
Magnetic Fields	EN61000-4-8	30 A/m	A	

Mechanical Details

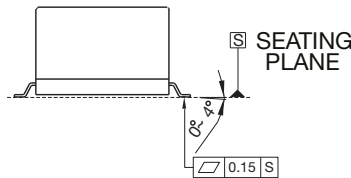
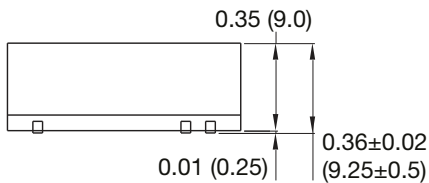
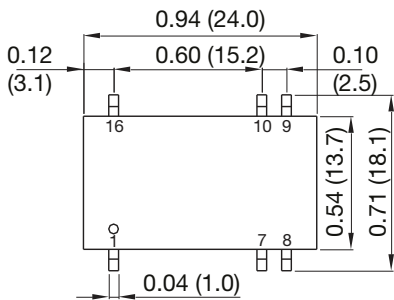

Connecting Pin Pattern

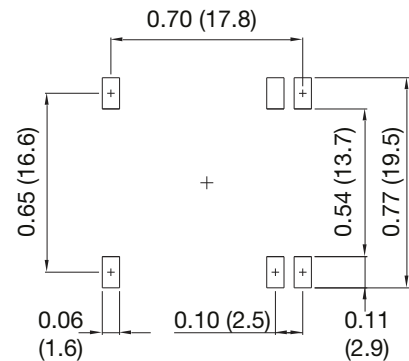

Pin Connections

Pin	Single	Dual
1	-Vin	-Vin
7	No Connection	No Connection
8	No Connection	Common
9	+Vout	+Vout
10	-Vout	-Vout
16	+Vin	+Vin

Application Notes

Derating Curve

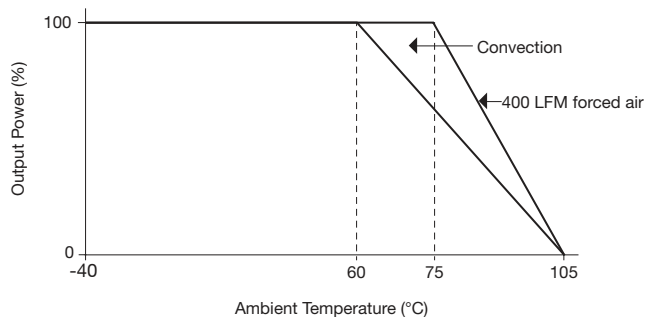

EMC Circuit for Class A

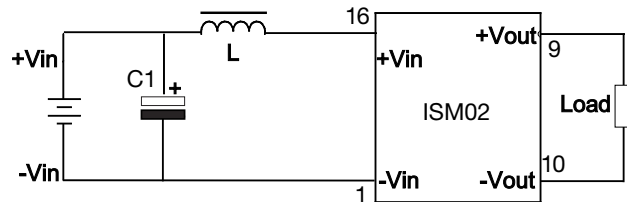

C1	L
2.2µF/150V	88µH

Notes

- All dimensions are in inches (mm)
- Weight: 0.01 lbs (3.75 g) approx.
- Tolerance: X.XX±0.01 (X.X±0.25)
X.XXX±0.005 (X.XX±0.13)
- Pin Tolerance: ±0.002 (±0.05)