

UNR511x Series (UN511x Series)

Silicon PNP epitaxial planar type

For digital circuits

■ Features

- Costs can be reduced through downsizing of the equipment and reduction of the number of parts
- S-Mini type package, allowing automatic insertion through the tape/magazine packing

■ Resistance by Part Number

	Marking symbol	(R ₁)	(R ₂)
• UNR5110 (UN5110)	6L	47 kΩ	—
• UNR5111 (UN5111)	6A	10 kΩ	10 kΩ
• UNR5112 (UN5112)	6B	22 kΩ	22 kΩ
• UNR5113 (UN5113)	6C	47 kΩ	47 kΩ
• UNR5114 (UN5114)	6D	10 kΩ	47 kΩ
• UNR5115 (UN5115)	6E	10 kΩ	—
• UNR5116 (UN5116)	6F	4.7 kΩ	—
• UNR5117 (UN5117)	6H	22 kΩ	—
• UNR5118 (UN5118)	6I	0.51 kΩ	5.1 kΩ
• UNR5119 (UN5119)	6K	1 kΩ	10 kΩ
• UNR511D (UN511D)	6M	47 kΩ	10 kΩ
• UNR511E (UN511E)	6N	47 kΩ	22 kΩ
• UNR511F (UN511F)	6O	4.7 kΩ	10 kΩ
• UNR511H (UN511H)	6P	2.2 kΩ	10 kΩ
• UNR511L (UN511L)	6Q	4.7 kΩ	4.7 kΩ
• UNR511M (UN511M)	EI	2.2 kΩ	47 kΩ
• UNR511N (UN511N)	EW	4.7 kΩ	47 kΩ
• UNR511T (UN511T)	EY	22 kΩ	47 kΩ
• UNR511V (UN511V)	FC	2.2 kΩ	2.2 kΩ
• UNR511Z (UN511Z)	FE	4.7 kΩ	22 kΩ

■ Absolute Maximum Ratings T_a = 25°C

Parameter	Symbol	Rating	Unit
Collector-base voltage (Emitter open)	V _{CBO}	-50	V
Collector-emitter voltage (Base open)	V _{CEO}	-50	V
Collector current	I _C	-100	mA
Total power dissipation	P _T	150	mW
Junction temperature	T _j	150	°C
Storage temperature	T _{stg}	-55 to +150	°C

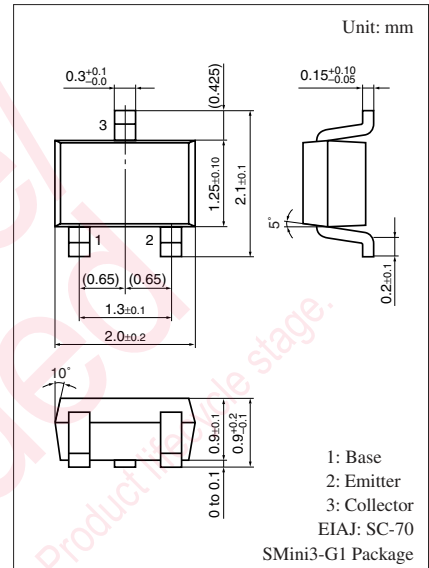

Internal Connection

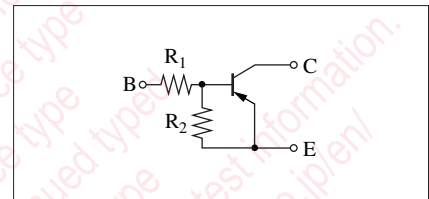

(Note) The part numbers in the parenthesis show conventional part number.

■ Electrical Characteristics $T_a = 25^\circ\text{C} \pm 3^\circ\text{C}$

Parameter		Symbol	Conditions	Min	Typ	Max	Unit	
Collector-base voltage (Emitter open)		V_{CBO}	$I_C = -10 \mu\text{A}, I_E = 0$	-50			V	
Collector-emitter voltage (Base open)		V_{CEO}	$I_C = -2 \text{ mA}, I_B = 0$	-50			V	
Collector-base cutoff current (Emitter open)		I_{CBO}	$V_{CB} = -50 \text{ V}, I_E = 0$			-0.1	μA	
Collector-emitter cutoff current (Base open)		I_{CEO}	$V_{CE} = -50 \text{ V}, I_B = 0$			-0.5	μA	
Emitter-base cutoff current (Collector open)	UNR5110/5115/5116/5117	I_{EBO}	$V_{EB} = -6 \text{ V}, I_C = 0$			-0.01	mA	
	UNR5113					-0.1		
	UNR5112/5114/511D/511E/511M/511N/511T					-0.2		
	UNR511Z					-0.4		
	UNR5111					-0.5		
	UNR511F/511H					-1.0		
	UNR5119					-1.5		
	UNR5118/511L/511V					-2.0		
Forward current transfer ratio	UNR511V	h_{FE}	$V_{CE} = -10 \text{ V}, I_C = -5 \text{ mA}$	6		20	—	
	UNR5118/511L			20				
	UNR5119/511D/511F/511H			30				
	UNR5111			35				
	UNR5112/511E			60				
	UNR511Z			60	200			
	UNR5113/5114/511M			80				
	UNR511N/511T			80	400			
	UNR5110*/5115*/5116*/5117*			160	460			
Collector-emitter saturation voltage		$V_{CE(sat)}$	$I_C = -10 \text{ mA}, I_B = -0.3 \text{ mA}$			-0.25	V	
	UNR511V			$I_C = -10 \text{ mA}, I_B = -1.5 \text{ mA}$				
Output voltage high-level	V_{OH}		$V_{CC} = -5 \text{ V}, V_B = -0.5 \text{ V}, R_L = 1 \text{ k}\Omega$	-4.9			V	
Output voltage low-level		V_{OL}	$V_{CC} = -5 \text{ V}, V_B = -2.5 \text{ V}, R_L = 1 \text{ k}\Omega$			-0.2	V	
	UNR5113			$V_{CC} = -5 \text{ V}, V_B = -3.5 \text{ V}, R_L = 1 \text{ k}\Omega$				
	UNR511D			$V_{CC} = -5 \text{ V}, V_B = -10 \text{ V}, R_L = 1 \text{ k}\Omega$				
	UNR511E			$V_{CC} = -5 \text{ V}, V_B = -6 \text{ V}, R_L = 1 \text{ k}\Omega$				
Transition frequency		f_T	$V_{CB} = -10 \text{ V}, I_E = 1 \text{ mA}, f = 200 \text{ MHz}$		80		MHz	
	UNR5116			$V_{CB} = -10 \text{ V}, I_E = 2 \text{ mA}, f = 200 \text{ MHz}$		150		
Input resistance	UNR5118	R_1		-30%	0.51	+30%	k Ω	
	UNR5119				1.0			
	UNR511H/511M/511V				2.2			
	UNR5116/511F/511L/511N/511Z				4.7			
	UNR5111/5114/5115				10			
	UNR5112/5117/511T				22			
	UNR5110/5113/511D/511E				47			
Resistance ratio	UNR511M	R_1/R_2			0.047		—	
	UNR511N				0.1			
	UNR5118/5119			0.08	0.10	0.12		
	UNR511Z				0.21			

■ Electrical Characteristics (continued) $T_a = 25^\circ\text{C} \pm 3^\circ\text{C}$

Parameter		Symbol	Conditions	Min	Typ	Max	Unit
Resistance ratio	UNR5114			0.17	0.21	0.25	
	UNR511H			0.17	0.22	0.27	
	UNR511T				0.47		
	UNR511F			0.37	0.47	0.57	
	UNR511V				1.0		
	UNR5111/5112/5113/511L			0.8	1.0	1.2	
	UNR511E			1.70	2.14	2.60	
	UNR511D			3.7	4.7	5.7	

Note) 1. Measuring methods are based on JAPANESE INDUSTRIAL STANDARD JIS C 7030 measuring methods for transistors.

2. *: Rank classification

Rank	Q	R	S	No-rank
h_{FE}	160 to 260	210 to 340	290 to 460	160 to 460

Common characteristics chart

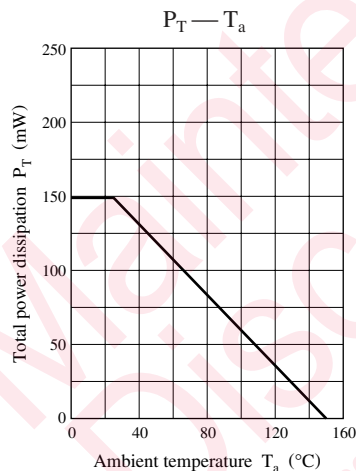

Characteristics charts of UNR5110

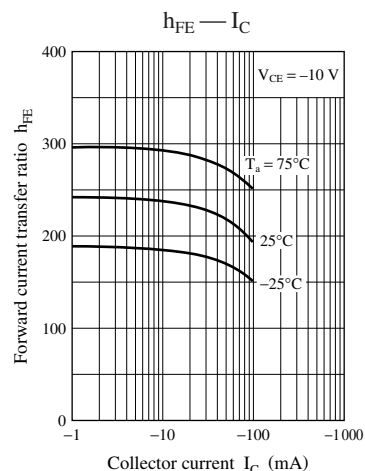
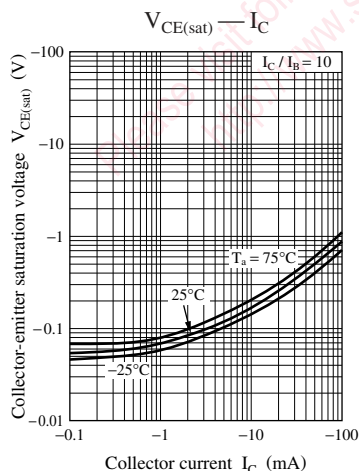
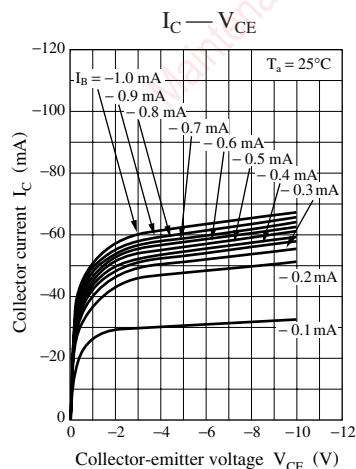

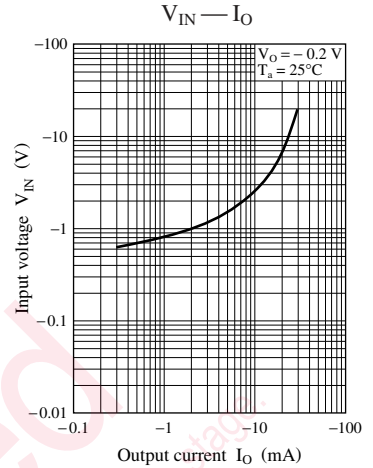
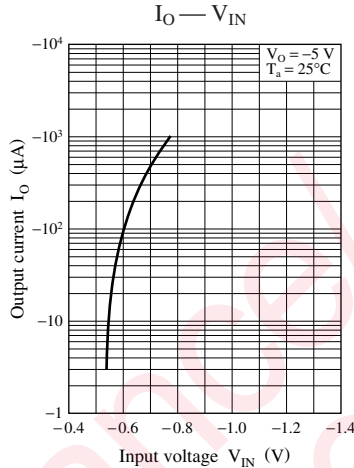
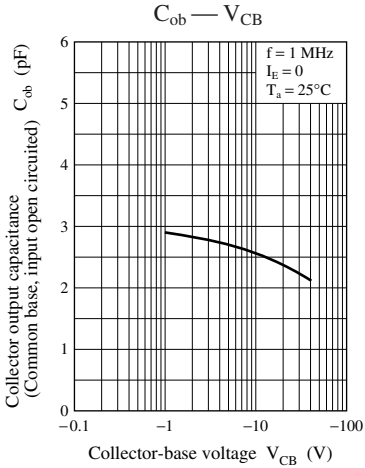

Characteristics charts of UNR5111

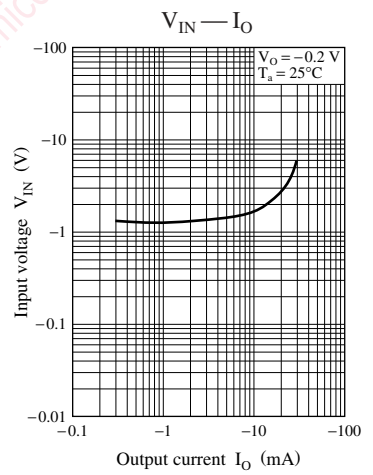
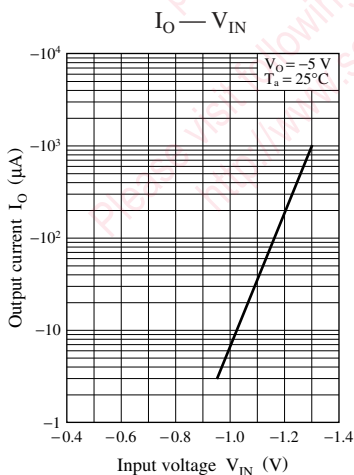
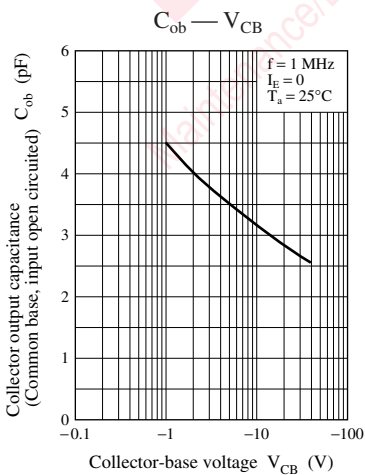
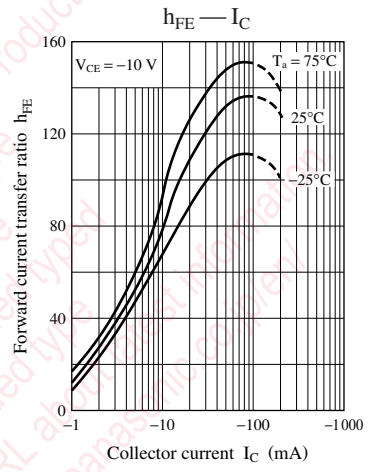
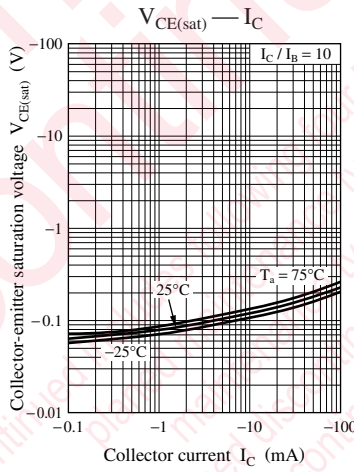
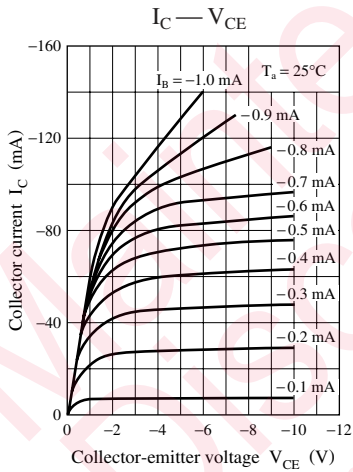

Characteristics charts of UNR5112

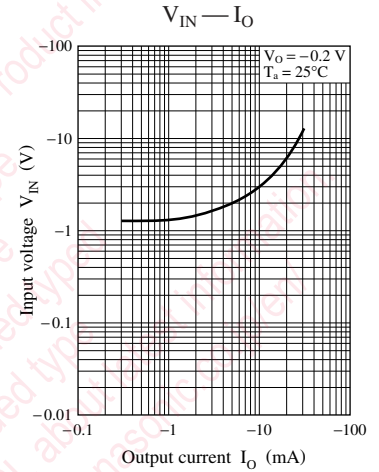
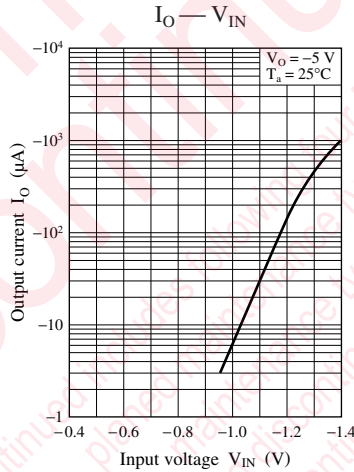
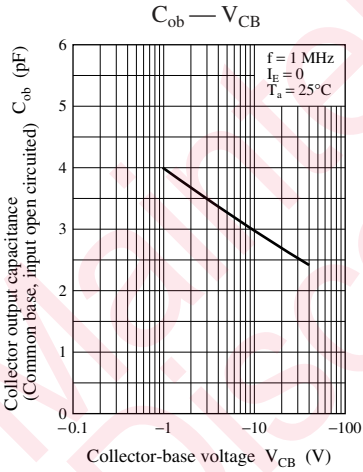
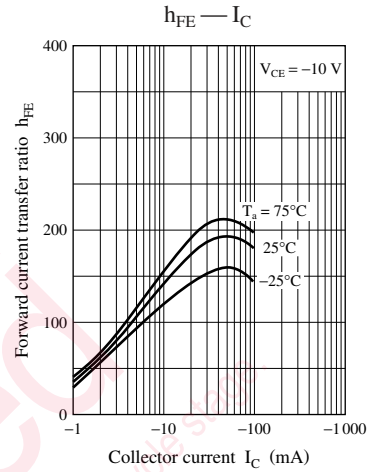
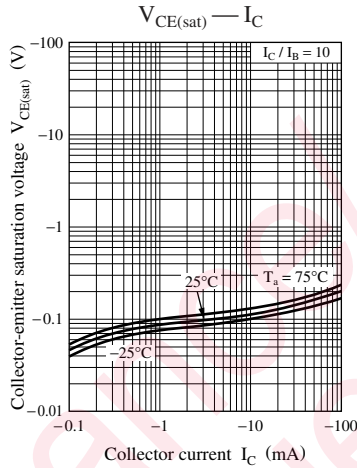
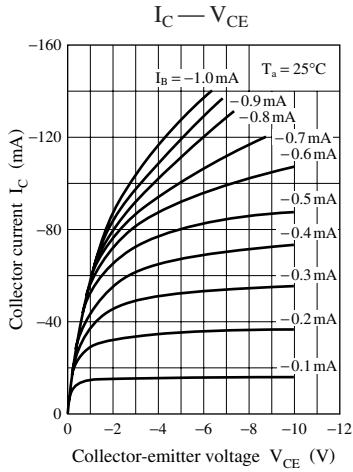

Characteristics charts of UNR5113

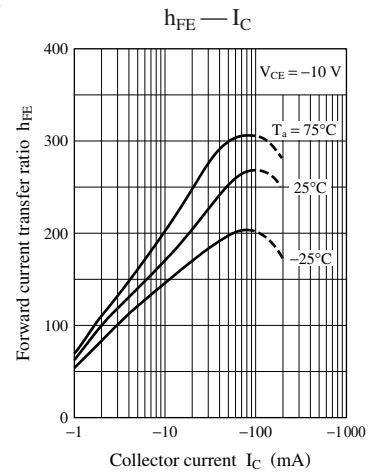
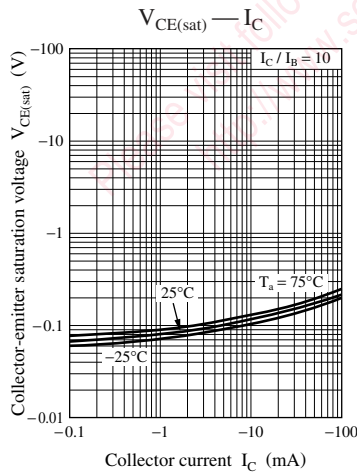
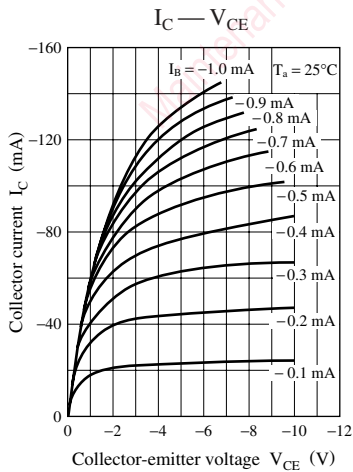

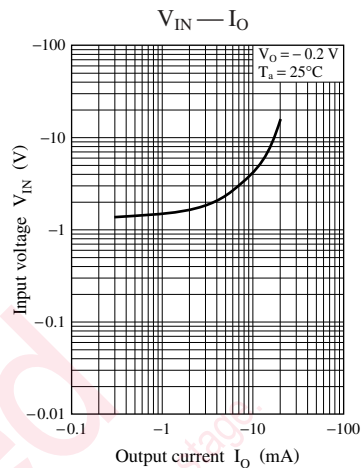
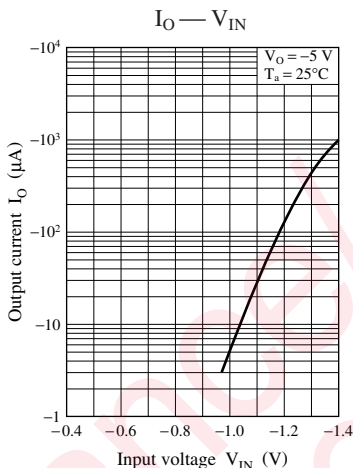
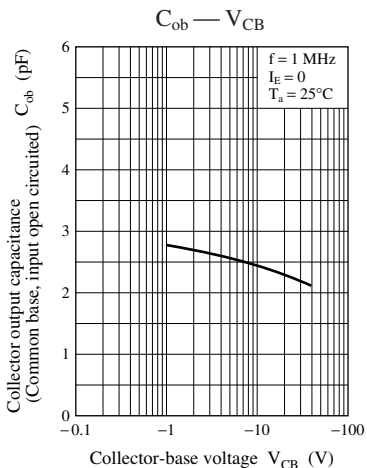

Characteristics charts of UNR5114

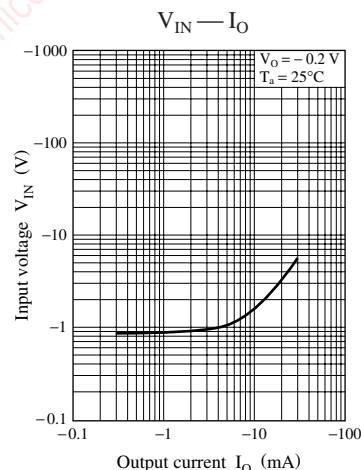
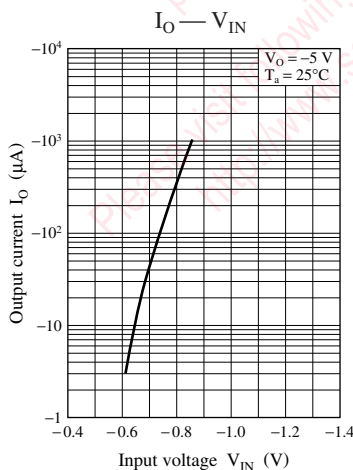
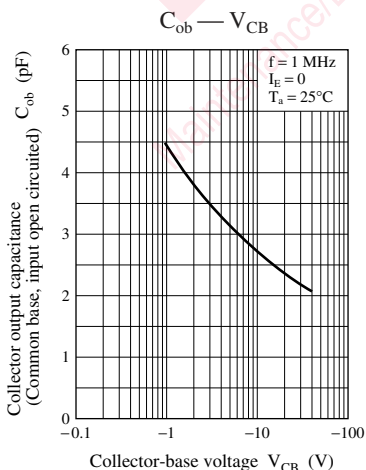
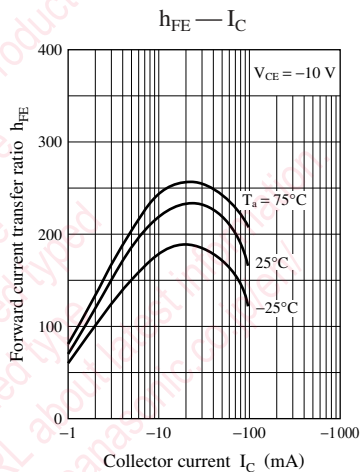
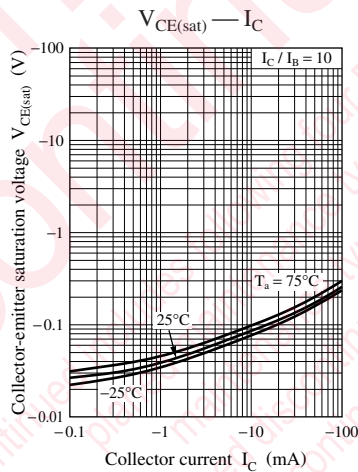
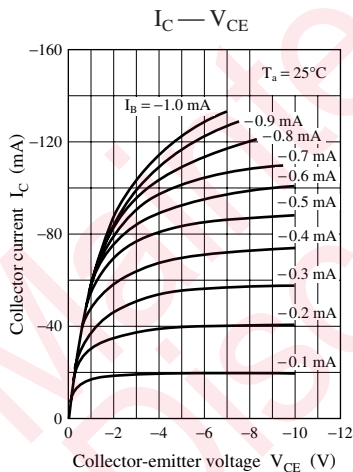

Characteristics charts of UNR5115

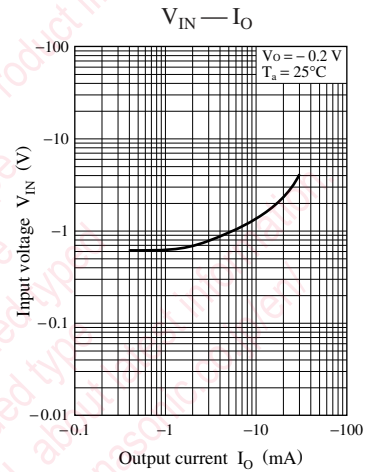
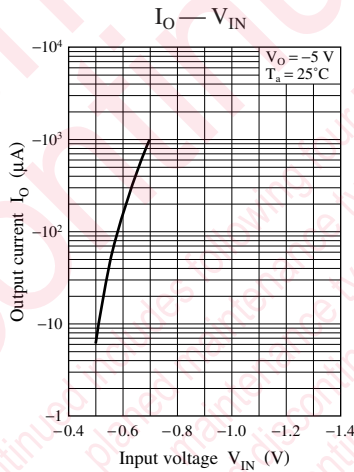
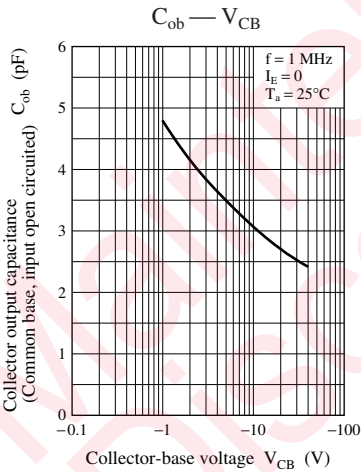
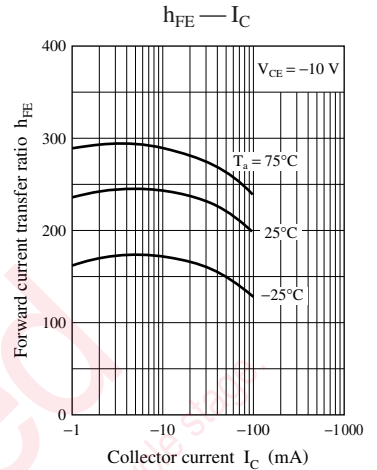
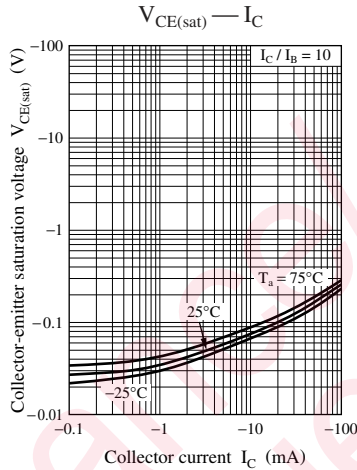
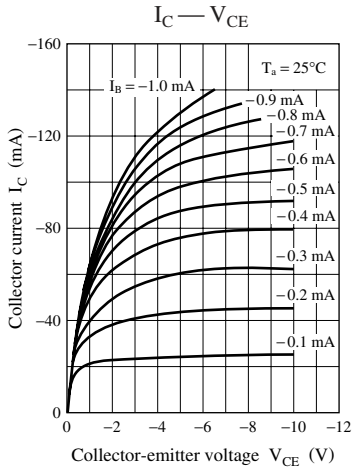

Characteristics charts of UNR5116

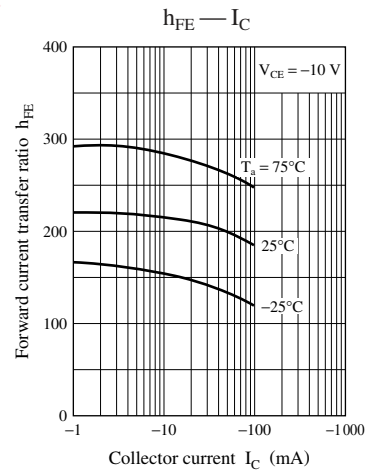
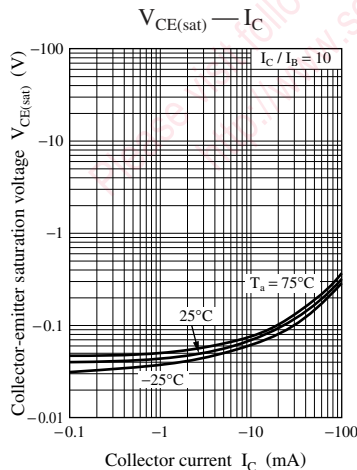
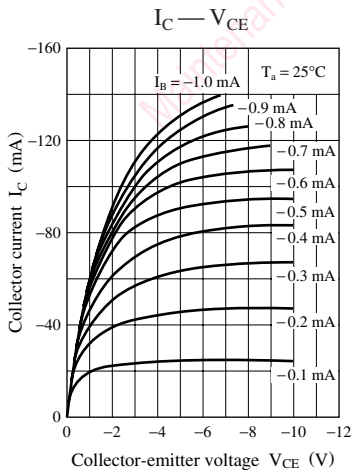

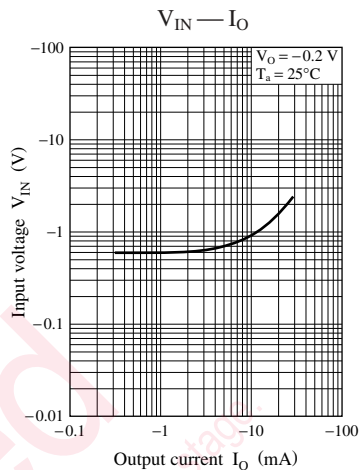
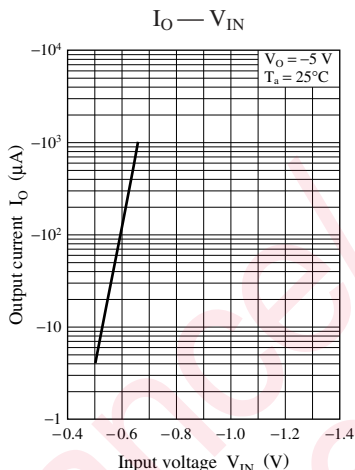
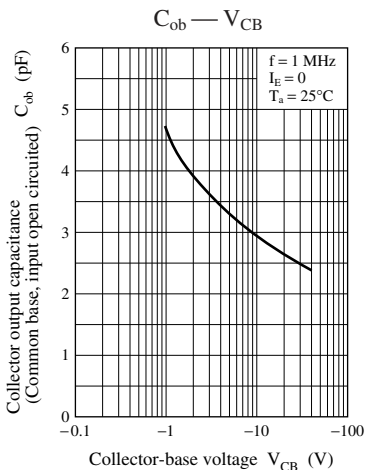

Characteristics charts of UNR5117

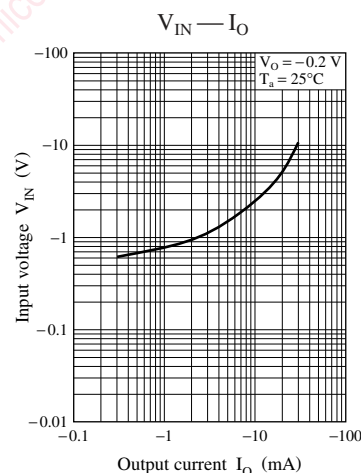
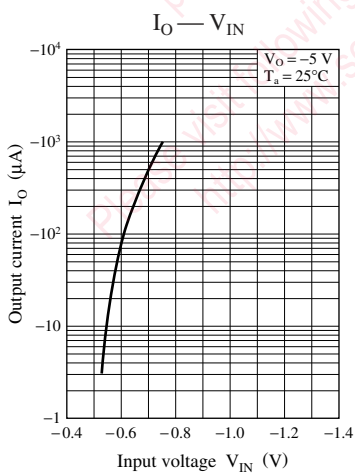
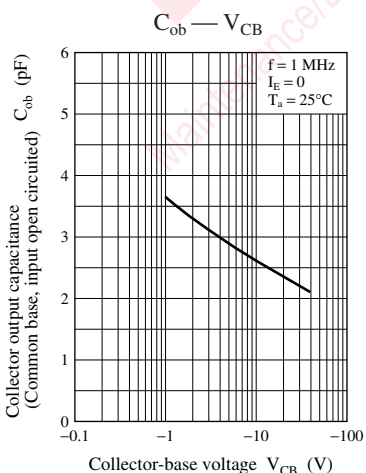
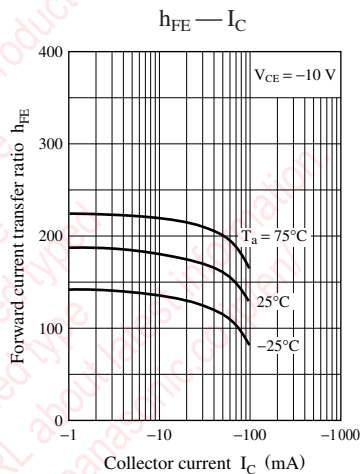
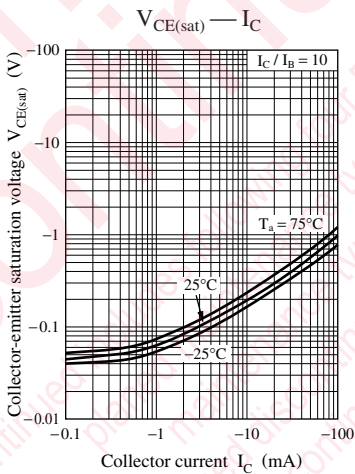
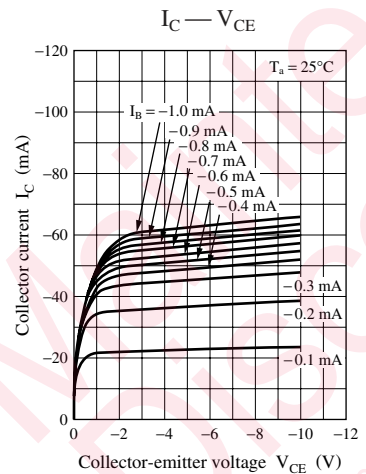

Characteristics charts of UNR5118

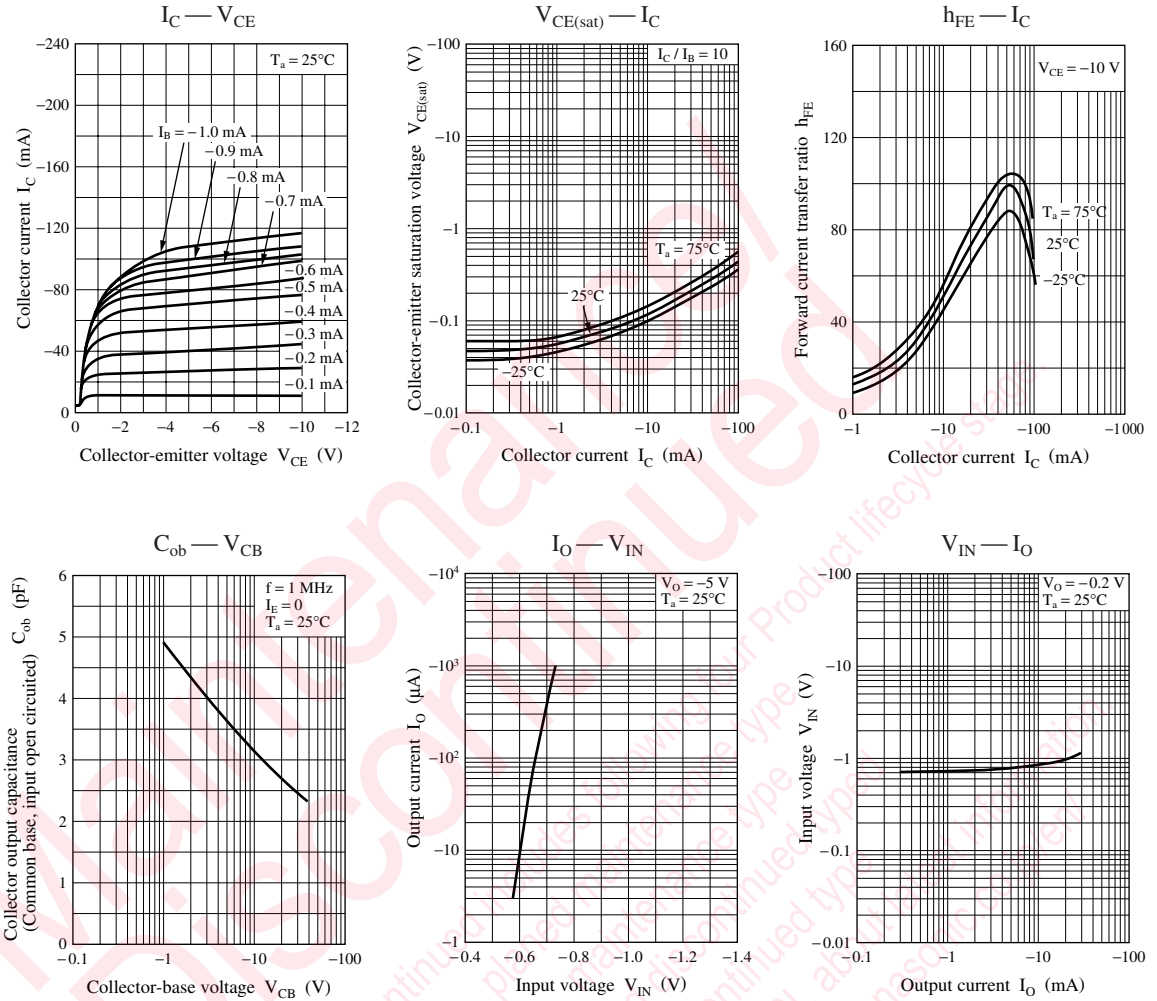

Characteristics charts of UNR5119

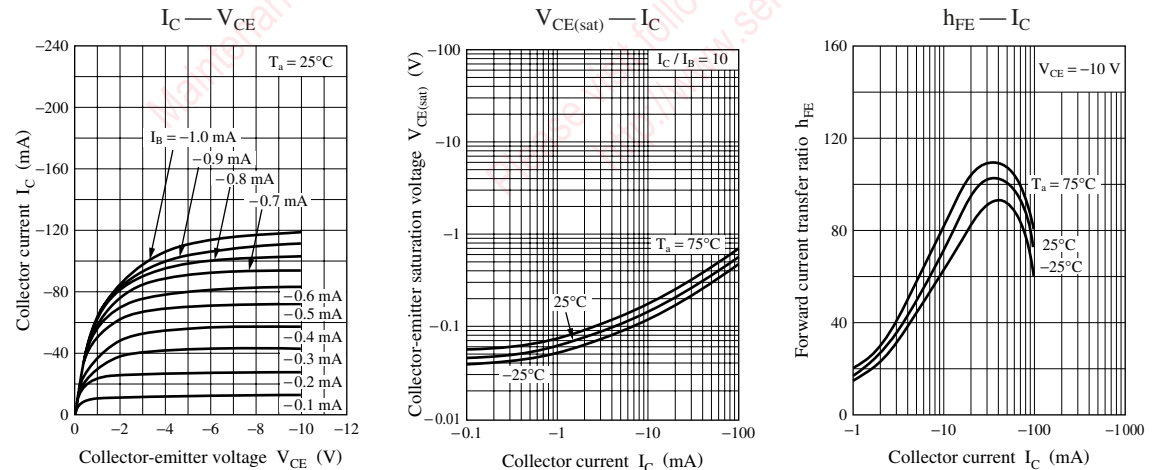

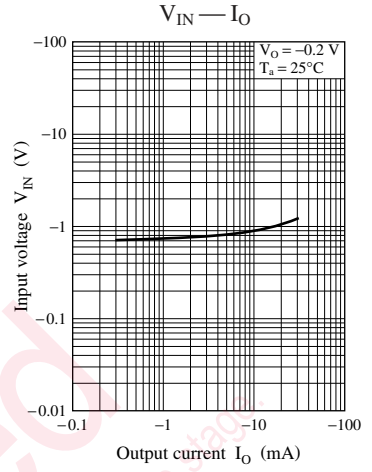
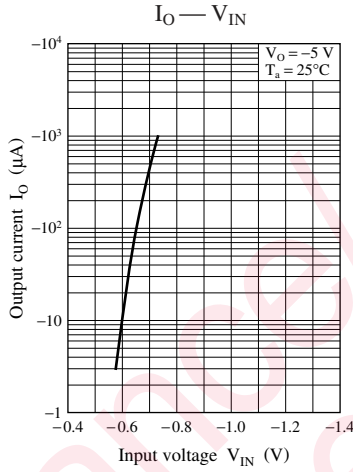
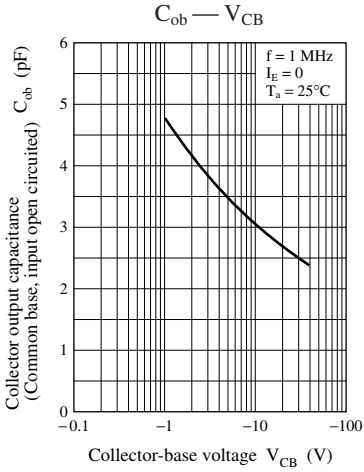

Characteristics charts of UNR511D

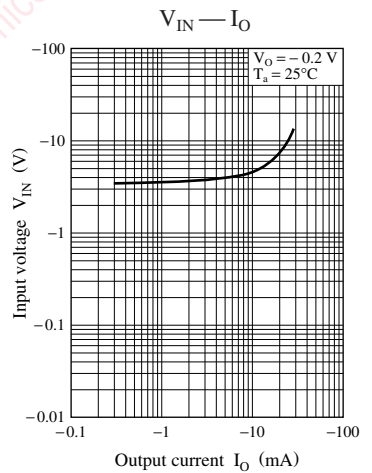
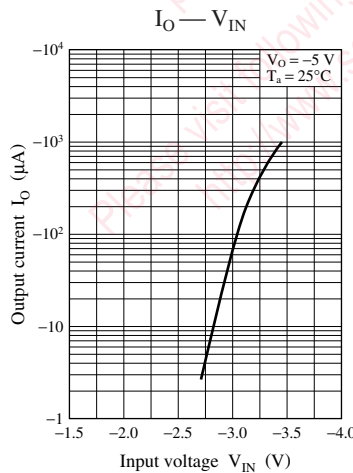
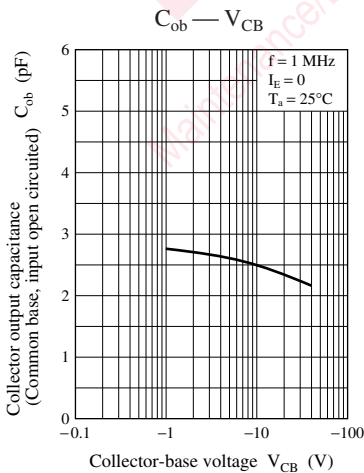
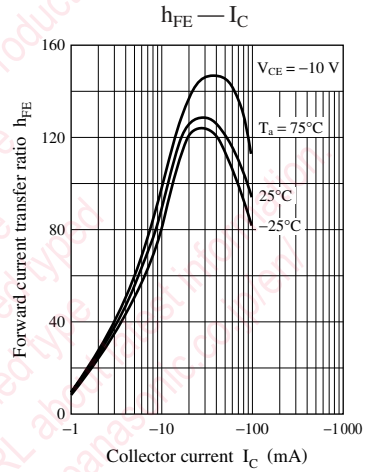
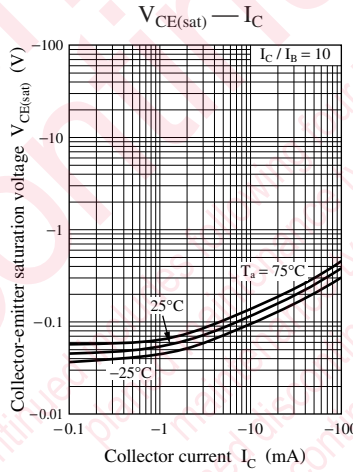
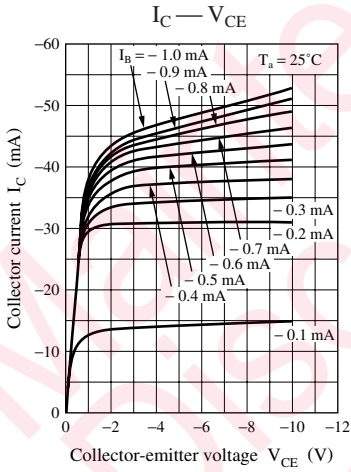

Characteristics charts of UNR511E

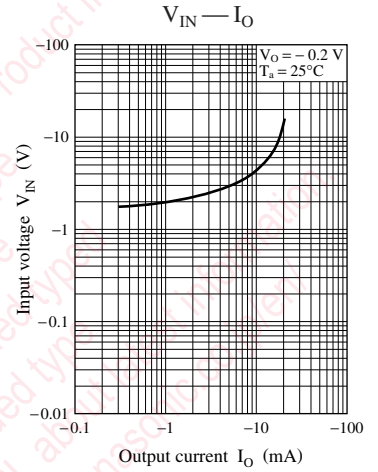
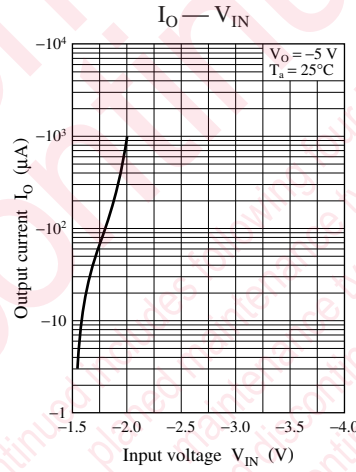
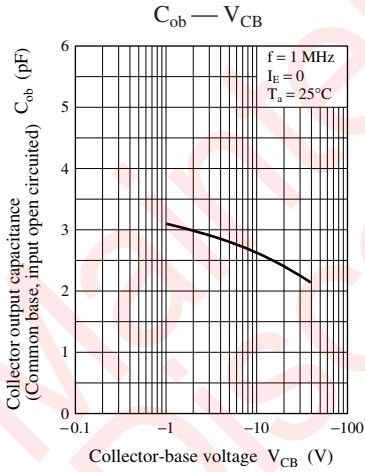
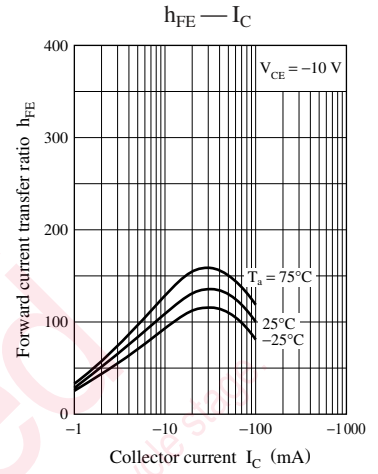
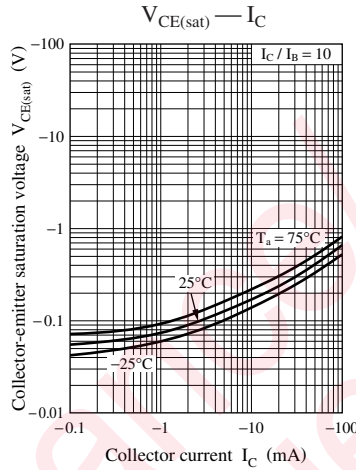
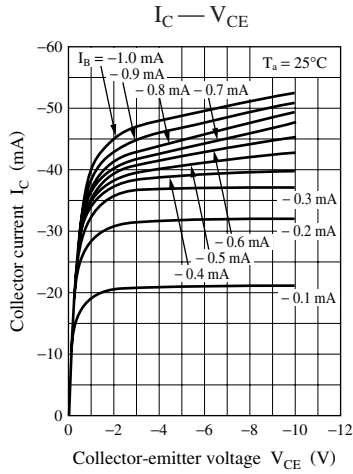

Characteristics charts of UNR511F

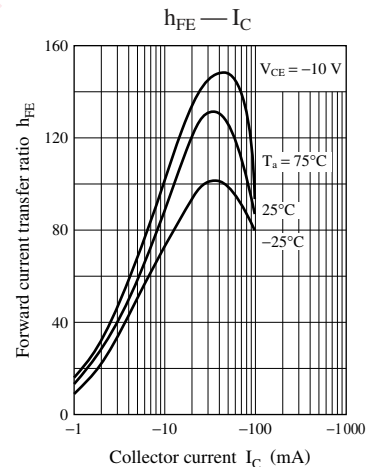
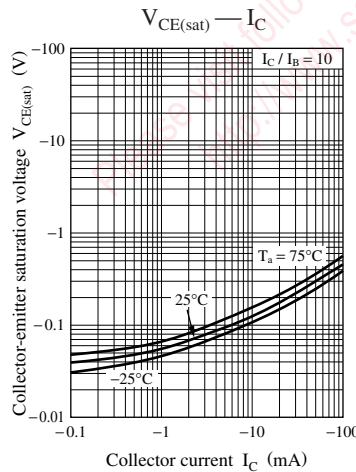
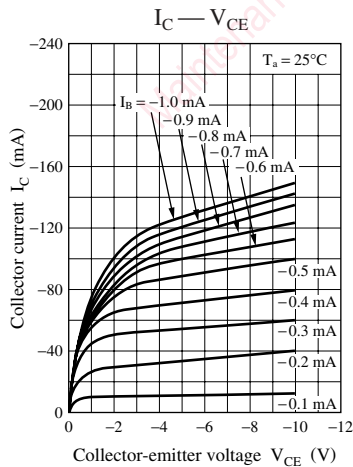

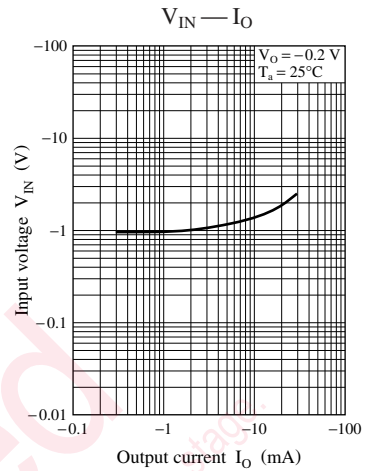
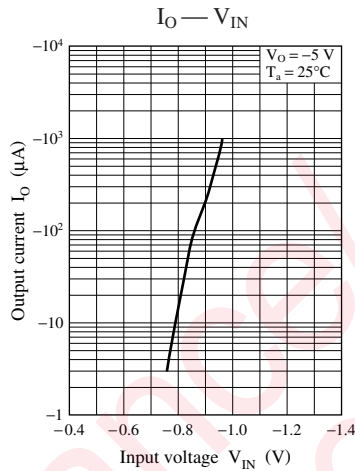
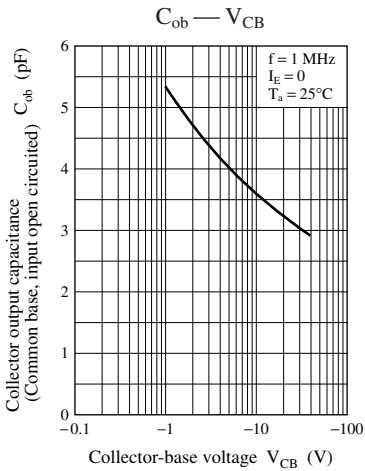

Characteristics charts of UNR511H

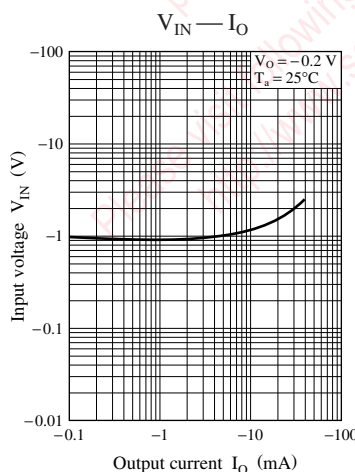
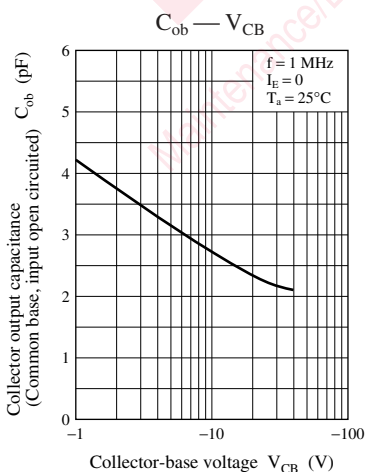
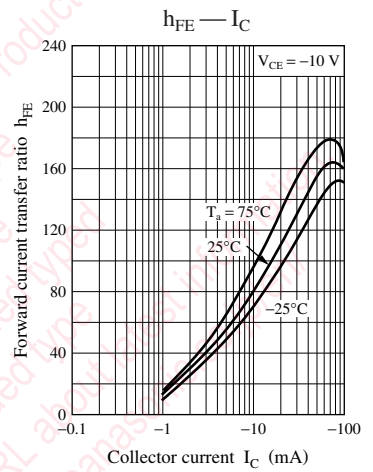
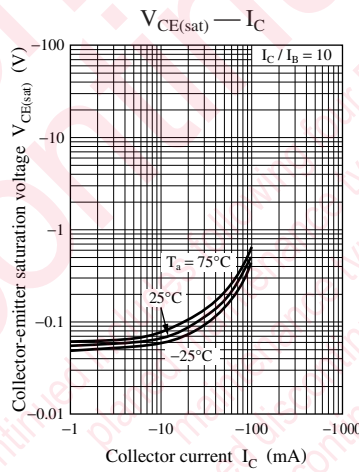
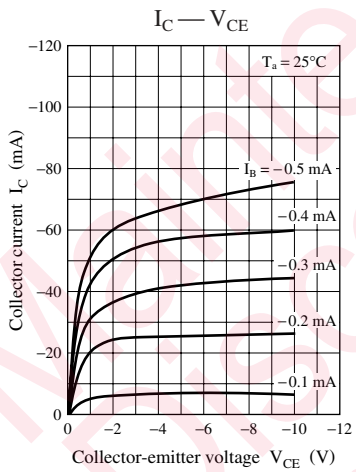

Characteristics charts of UNR511L

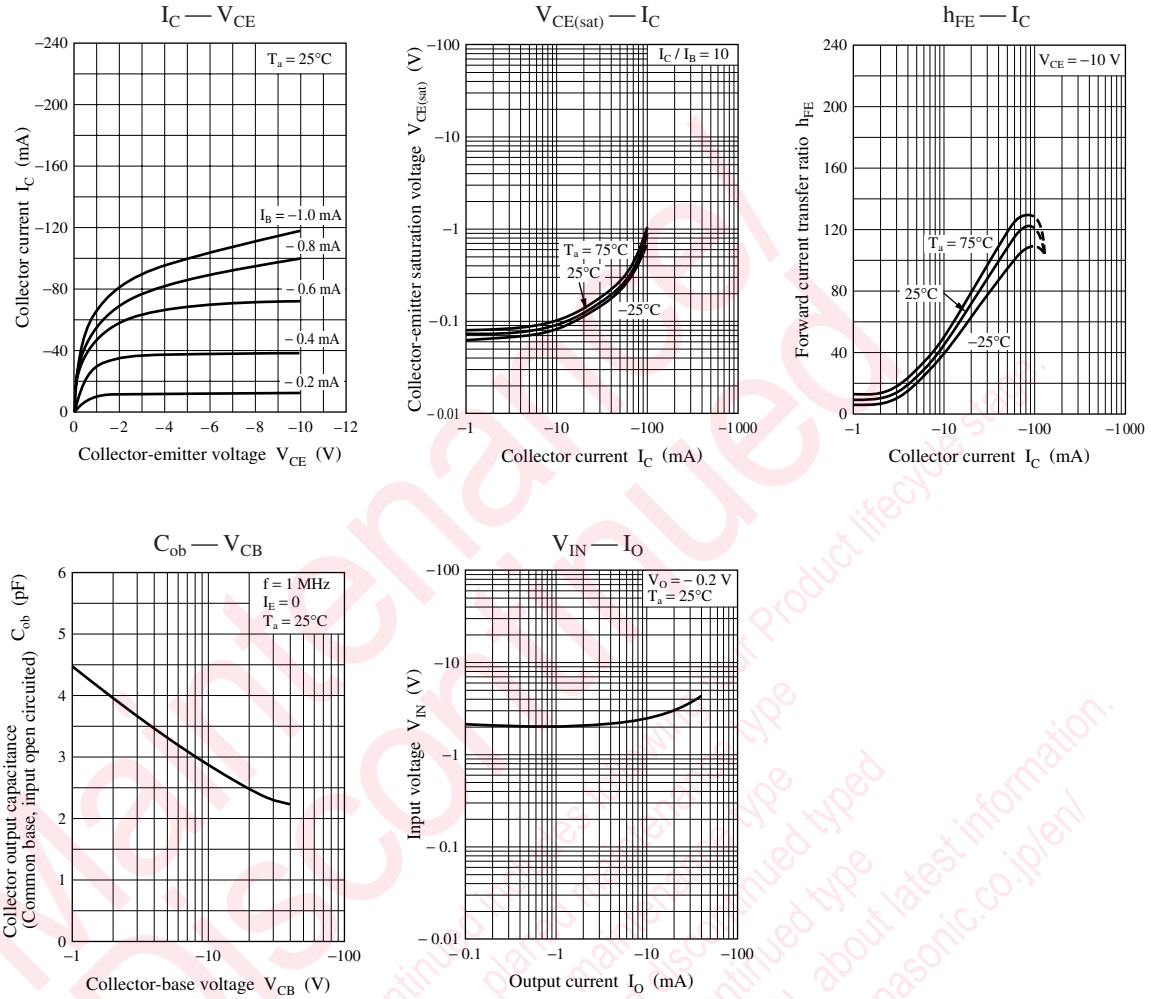

Characteristics charts of UNR511M

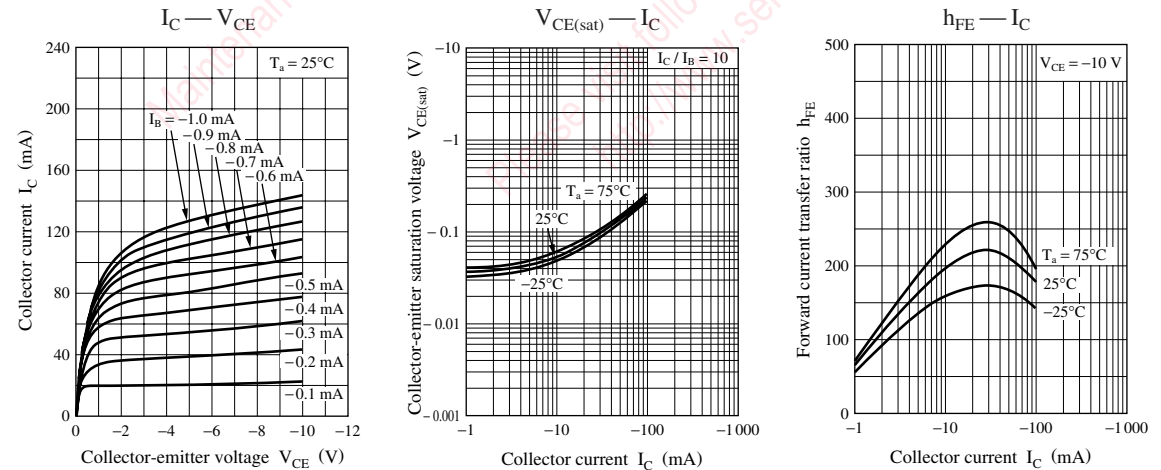

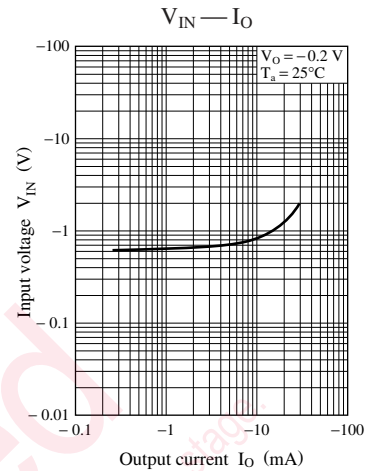
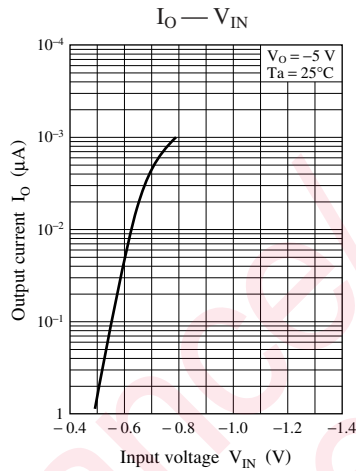
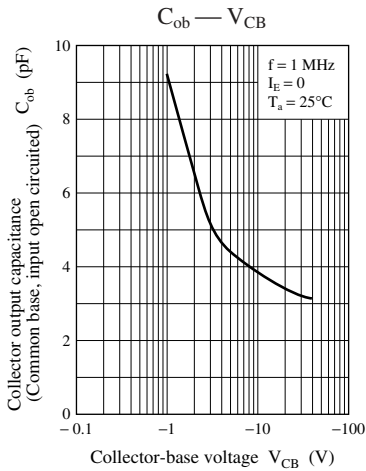

Characteristics charts of UNR511N

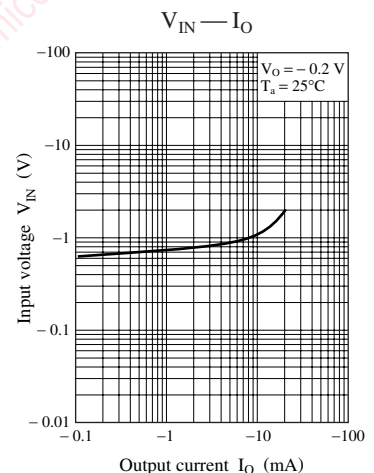
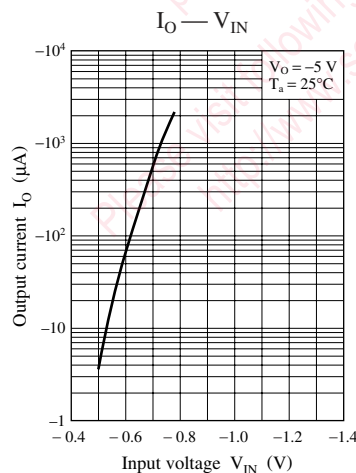
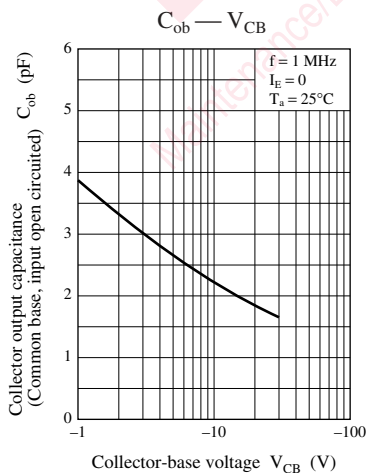
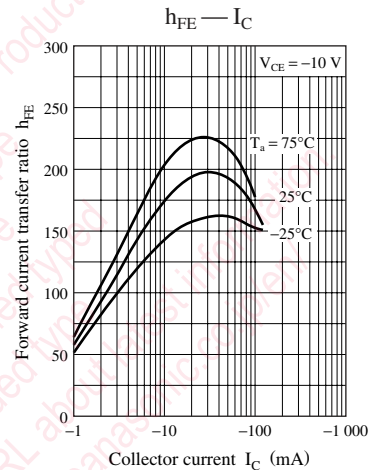
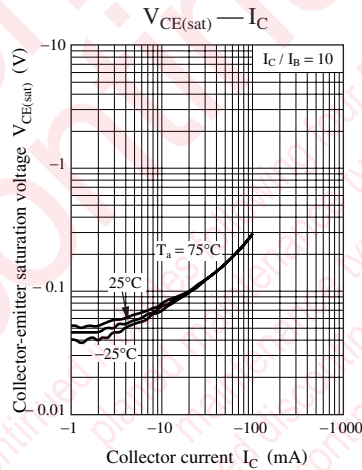
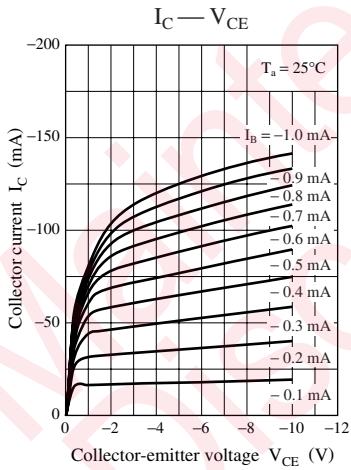

Characteristics charts of UNR511T

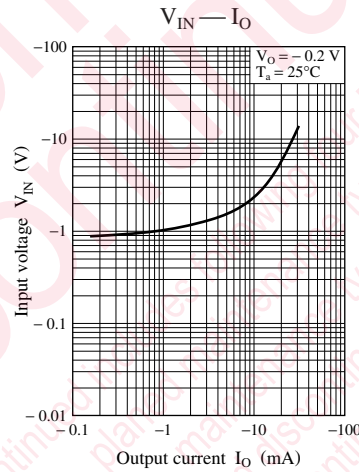
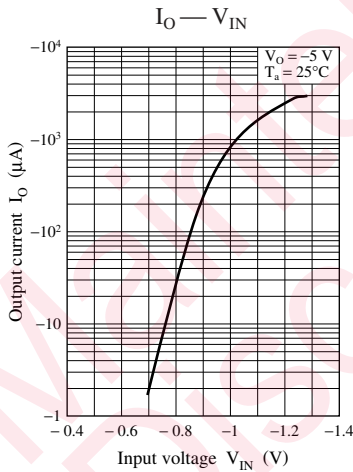
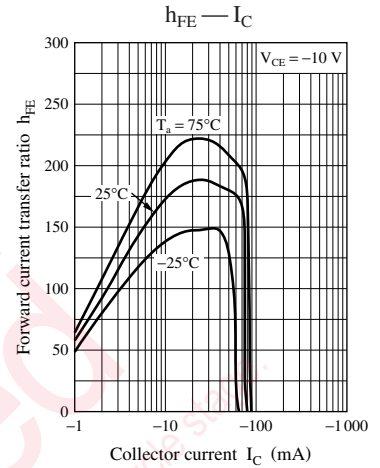
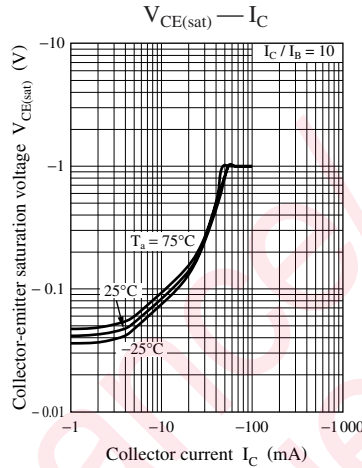
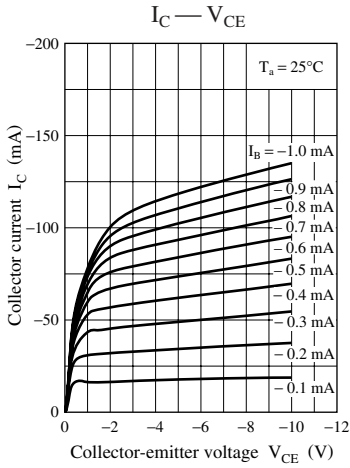

Characteristics charts of UNR511V

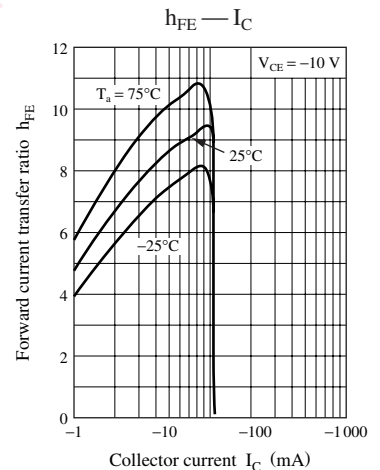
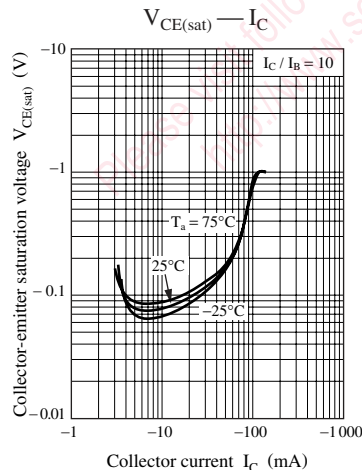
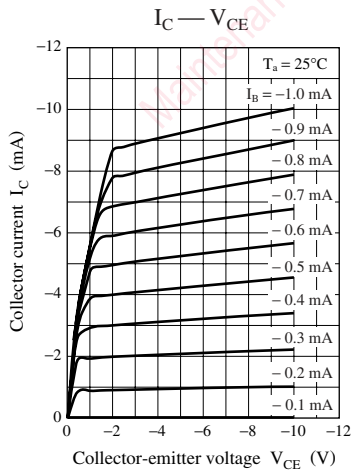

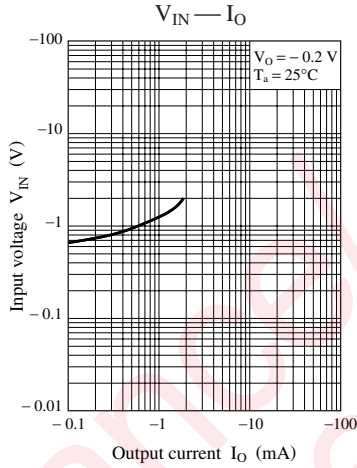
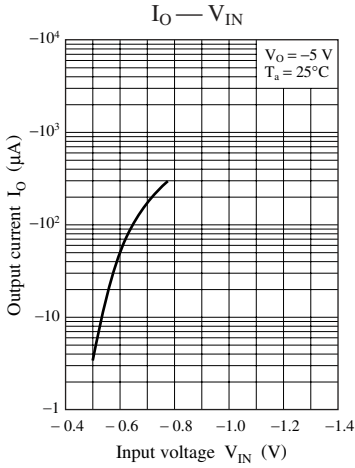

Characteristics charts of UNR511Z

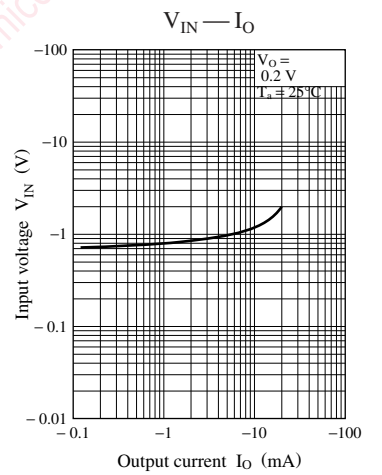
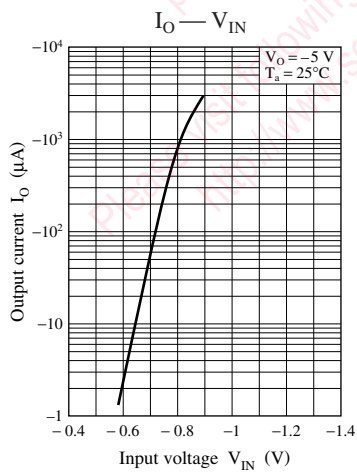
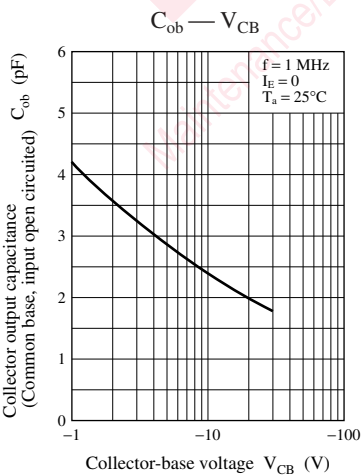
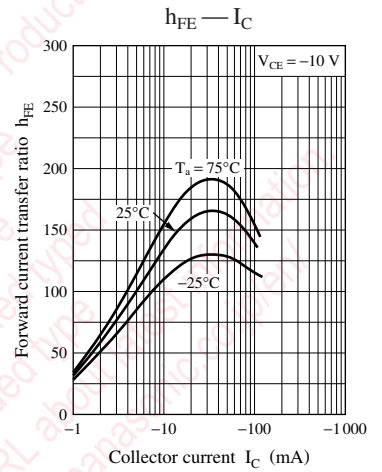
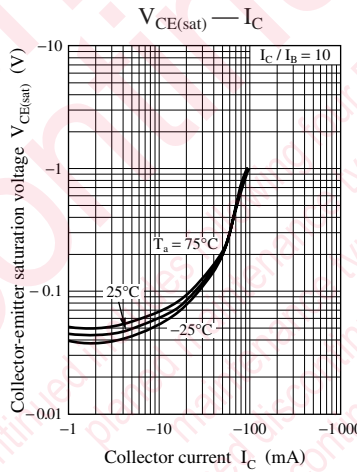
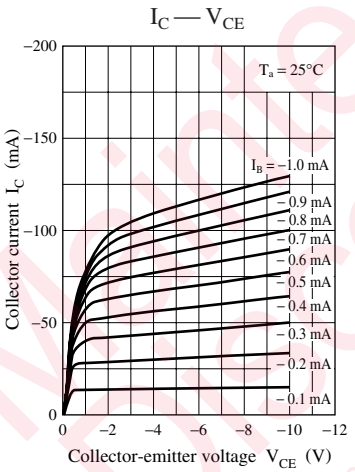

Request for your special attention and precautions in using the technical information and semiconductors described in this book

- (1) If any of the products or technical information described in this book is to be exported or provided to non-residents, the laws and regulations of the exporting country, especially, those with regard to security export control, must be observed.
- (2) The technical information described in this book is intended only to show the main characteristics and application circuit examples of the products, and no license is granted under any intellectual property right or other right owned by our company or any other company. Therefore, no responsibility is assumed by our company as to the infringement upon any such right owned by any other company which may arise as a result of the use of technical information described in this book.
- (3) The products described in this book are intended to be used for standard applications or general electronic equipment (such as office equipment, communications equipment, measuring instruments and household appliances).
Consult our sales staff in advance for information on the following applications:
 - Special applications (such as for airplanes, aerospace, automobiles, traffic control equipment, combustion equipment, life support systems and safety devices) in which exceptional quality and reliability are required, or if the failure or malfunction of the products may directly jeopardize life or harm the human body.
 - Any applications other than the standard applications intended.
- (4) The products and product specifications described in this book are subject to change without notice for modification and/or improvement. At the final stage of your design, purchasing, or use of the products, therefore, ask for the most up-to-date Product Standards in advance to make sure that the latest specifications satisfy your requirements.
- (5) When designing your equipment, comply with the range of absolute maximum rating and the guaranteed operating conditions (operating power supply voltage and operating environment etc.). Especially, please be careful not to exceed the range of absolute maximum rating on the transient state, such as power-on, power-off and mode-switching. Otherwise, we will not be liable for any defect which may arise later in your equipment.
Even when the products are used within the guaranteed values, take into the consideration of incidence of break down and failure mode, possible to occur to semiconductor products. Measures on the systems such as redundant design, arresting the spread of fire or preventing glitch are recommended in order to prevent physical injury, fire, social damages, for example, by using the products.
- (6) Comply with the instructions for use in order to prevent breakdown and characteristics change due to external factors (ESD, EOS, thermal stress and mechanical stress) at the time of handling, mounting or at customer's process. When using products for which damp-proof packing is required, satisfy the conditions, such as shelf life and the elapsed time since first opening the packages.
- (7) This book may be not reprinted or reproduced whether wholly or partially, without the prior written permission of Matsushita Electric Industrial Co., Ltd.