



# Aluminum electrolytic capacitors

Axial-lead and soldering star capacitors

**Series/Type:** B41689, B41789

**Date:** December 2019

### Applications

- Automotive electronics

### Features

- High vibration stability, special design with high vibration stability up to 60 g available upon request
- Very high ripple current capability
- Long useful life, 10000 h at up to 125 °C
- Low ESR also at rated voltage 63 V DC
- SIKOREL design – storage for up to 15 years at a temperature of up to 35 °C
- RoHS-compatible

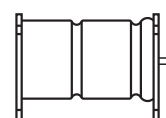
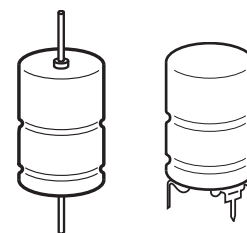

### Construction

- Charge/discharge-proof, polar
- Aluminum case with PET insulating sleeve
- Negative pole connected to case
- Version without insulating sleeve available upon request

### Terminals

- Axial leads, welded to capacitor case and cover disc
- Soldering star option for upright mounting on PCB or welding to busbar
- Alternative axial-lead design with double-sided plates for horizontal mounting available upon request

### Taping and packing

- Axial-lead capacitors will be delivered in pallet package  
Capacitors with  $d \times l \leq 16 \times 39$  mm are also available taped on reel
- Soldering star capacitors are packed in blister trays

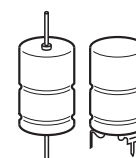
**Specifications and characteristics in brief**

|   |   |    |  |      |    |    |
|---|---|----|--|------|----|----|
| Rated voltage $V_R$   | 25 ... 63 V DC  |    |  |      |    |    |
| Surge voltage $V_S$   | $1.15 \cdot V_R$  |    |  |      |    |    |
| Rated capacitance $C_R$   | 360 ... 4500 $\mu\text{F}$  |    |  |      |    |    |
| Capacitance tolerance   | $-10/+30\% \triangleq Q$  |    |  |      |    |    |
| Leakage current $I_{\text{leak}}$<br>(5 min, 20 °C)   | $I_{\text{leak}} \leq 0.006 \mu\text{A} \cdot \left( \frac{C_R}{\mu\text{F}} \cdot \frac{V_R}{\text{V}} \right) + 4 \mu\text{A}$  |    |  |      |    |    |
| Self-inductance ESL <sup>1)</sup>   | Diameter d (mm)   |    | 16   | 18   | 20 | 21 |
|   | Terminals   |    | Length l (mm)  |      |    |    |
|   |   |    | Approx. ESL (nH)   |      |    |    |
|   | axial   | 25 | 26   | 30   | –  | –  |
|   |   | 29 | –  | –    | 38 | –  |
|   |   | 30 | 29   | 34   | –  | 39 |
|   |   | 35 | 31   | 36   | –  | 41 |
|   |   | 39 | 33   | 38   | –  | 45 |
|   |   | 49 | –  | –    | –  | 50 |
|   | soldering star  | 25 | 7  | 8    | –  | –  |
|   |   | 30 | 8  | 10   | –  | 11 |
|   |   | 35 | 9  | 10.5 | –  | 12 |
| 39  |   | 9  | 11   | –    | 13 |    |
| 49  |   | –  | –  | –    | 14 |    |
| Useful life <sup>2)</sup><br>150 °C; $V_R$ ; $0.5 \cdot I_{AC,R}$<br>125 °C; $V_R$ ; $I_{AC,max}$<br>125 °C; $V_R$ ; $I_{AC,R}$ | > 2000 h <sup>3)</sup><br>> 4000 h<br>> 10000 h   |    | Requirements:  |      |    |    |
|   |   |    | $ \Delta C/C  \leq 30\%$ of initial value                  |      |    |    |
|   |   |    | $I_{\text{leak}} \leq$ initial specified limit             |      |    |    |
| Voltage endurance test<br>125 °C; $V_R$   | 4000 h for $V_R \leq 40$ V DC<br>3000 h for $V_R = 63$ V DC   |    | Post test requirements:                                    |      |    |    |
|   |   |    | $ \Delta C/C  \leq 10\%$ of initial value                  |      |    |    |
|   |   |    | ESR $\leq 1.3$ times initial specified limit <sup>4)</sup> |      |    |    |
| Vibration resistance test   | $I_{\text{leak}} \leq$ initial specified limit  |    |  |      |    |    |
|   | To IEC 60068-2-6, test Fc:  |    |  |      |    |    |
|   | Frequency range 10 Hz ... 2 kHz, displacement amplitude max. 1.5 mm, acceleration max. 20 g, duration 3 × 2 h.<br>Capacitor rigidly clamped by the aluminum case e.g. using our standard fixture. |    |  |      |    |    |
| IEC climatic category   | To IEC 60068-1: 55/125/56 (–55 °C/+125 °C/56 days damp heat test)   |    |  |      |    |    |
| Sectional specification   | IEC 60384-4   |    |  |      |    |    |
| Reference standard  | AEC-Q200 <sup>5)</sup>  |    |  |      |    |    |

1) If optimum circuit design is used, the values are lower by 30%.

2) Refer to chapter "General technical information, 5 Useful life" on how to interpret useful life.

3) Continuous operation above 130 °C is limited to a maximum of 100 h per load duration, and it must be followed by a no-load cycle or operation under 130 °C for at least the same duration.

4)  $ESR_{\text{max}}$  at 100 Hz, 20 °C

5) Refer to chapter "General technical information, 2.3 AEC-Q200 standard" for further details.

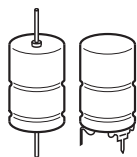

**B41689, B41789**

**Very high ripple current – up to 150 °C**

**B41689, Axial-lead capacitors**

**Dimensional drawing**

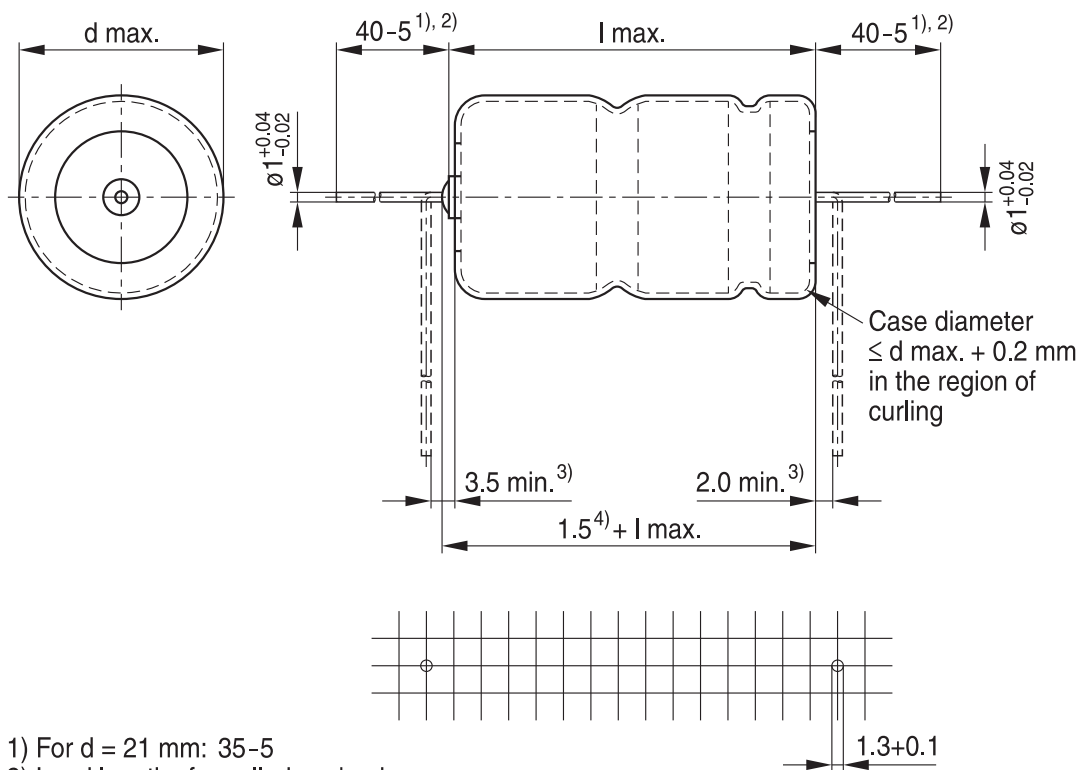

- 1) For d = 21 mm: 35-5
- 2) Lead lengths for palled packaging
- 3) Minimum bending distance recommended per wire
- 4) Maximum length of welding projection

KAL1749-V-E

**Dimensions, weights and packing units**

| d × l<br>mm | d <sub>max</sub> × l <sub>max</sub><br>mm | Approx. weight<br>g | Packing units (pcs.) |      |
|-------------|---|---------------------|----------------------|------|
|             |   |                     | Pallet               | Reel |
| 16 × 25     | 16.5 × 25.5                               | 7.4                 | 180                  | 250  |
| 16 × 30     | 16.5 × 30.5                               | 8.9                 | 180                  | 250  |
| 16 × 35     | 16.5 × 35.5                               | 10.4                | 180                  | 250  |
| 16 × 39     | 16.5 × 40                                 | 11.7                | 180                  | 250  |
| 18 × 25     | 18.5 × 25.5                               | 9.3                 | 160                  | —    |
| 18 × 30     | 18.5 × 30.5                               | 11.1                | 160                  | —    |
| 18 × 35     | 18.5 × 35.5                               | 12.8                | 160                  | —    |
| 18 × 39     | 18.5 × 40                                 | 14.7                | 160                  | —    |
| 20 × 29     | 20.5 × 29.5                               | 13.5                | 140                  | —    |
| 21 × 30     | 21.5 × 30.5                               | 16.5                | 140                  | —    |
| 21 × 35     | 21.5 × 35.5                               | 17.0                | 140                  | —    |
| 21 × 39     | 21.5 × 40                                 | 20.0                | 140                  | —    |
| 21 × 49     | 21.5 × 50                                 | 25.0                | 110                  | —    |

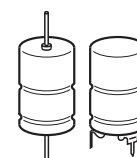
**B41789, Soldering star capacitors**
**Dimensional drawings**

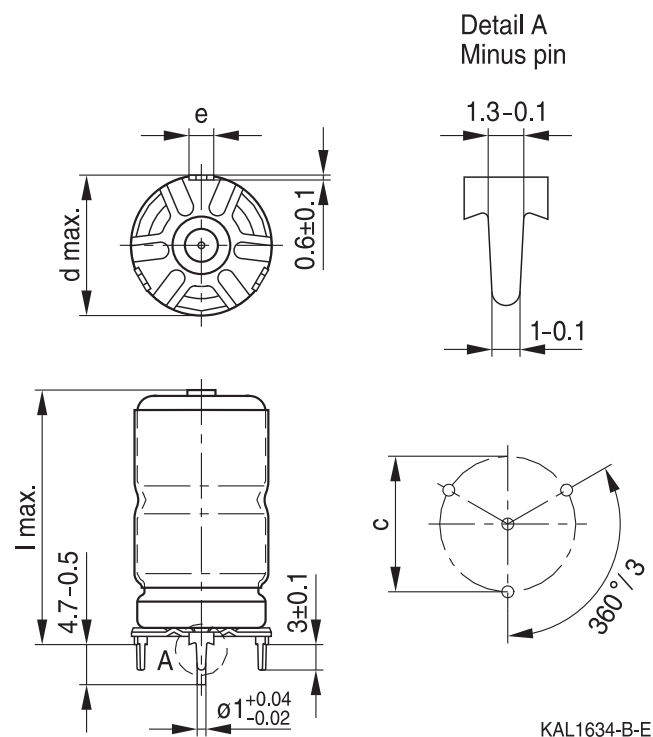
 Mounting holes  $d = 16 \text{ mm} \dots 21 \text{ mm}$ 

**Dimensions, weights and packing units**

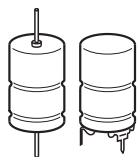
| $d \times l$<br>mm | $d_{\max} \times l_{\max}$<br>mm | $c \pm 0.1$<br>mm | $e \pm 0.1$<br>mm | Approx. weight<br>g | Packing units<br>pcs. |
|--------------------|----------------------------------|-------------------|-------------------|---------------------|-----------------------|
| 16 × 25            | 17.5 × 27                        | 16.5              | 3.0               | 7.9                 | 300                   |
| 16 × 30            | 17.5 × 32                        | 16.5              | 3.0               | 9.4                 | 300                   |
| 16 × 35            | 17.5 × 37                        | 16.5              | 3.0               | 10.9                | 200                   |
| 16 × 39            | 17.5 × 41.5                      | 16.5              | 3.0               | 12.2                | 200                   |
| 18 × 25            | 19.5 × 27                        | 18.5              | 3.0               | 9.9                 | 300                   |
| 18 × 30            | 19.5 × 32                        | 18.5              | 3.0               | 11.8                | 300                   |
| 18 × 35            | 19.5 × 37                        | 18.5              | 3.0               | 13.2                | 200                   |
| 18 × 39            | 19.5 × 41.5                      | 18.5              | 3.0               | 15.4                | 200                   |
| 21 × 30            | 22.5 × 32                        | 21.5              | 3.5               | 17.5                | 468                   |
| 21 × 35            | 22.5 × 37                        | 21.5              | 3.5               | 18.3                | 324                   |
| 21 × 39            | 22.5 × 41.5                      | 21.5              | 3.5               | 21.0                | 324                   |
| 21 × 49            | 22.5 × 51.5                      | 21.5              | 3.5               | 26.0                | 264                   |



**B41689, B41789**

**Very high ripple current – up to 150 °C**

### Overview of available types

| $V_R$ (V DC)            | 25                                | 40      | 63                 |
|-------------------------|-----------------------------------|---------|--------------------|
|                         | Case dimensions $d \times l$ (mm) |         |                    |
| $C_R$ ( $\mu\text{F}$ ) |                                   |         |                    |
| 360                     |                                   |         | 16 × 25            |
| 470                     |                                   |         | 18 × 25            |
| 510                     |                                   |         | 16 × 30            |
| 560                     |                                   | 16 × 25 |                    |
| 620                     |                                   |         | 16 × 35<br>18 × 30 |
| 680                     |                                   | 18 × 25 |                    |
| 720                     |                                   | 16 × 30 |                    |
| 750                     |                                   |         | 16 × 39            |
| 820                     |                                   | 16 × 35 | 18 × 35            |
| 900                     |                                   | 18 × 30 |                    |
| 910                     |                                   |         | 18 × 39<br>21 × 30 |
| 1000                    | 16 × 25                           | 16 × 39 |                    |
| 1100                    |                                   |         | 21 × 35            |
| 1200                    | 18 × 25                           | 20 × 29 |                    |
| 1300                    | 16 × 30                           |         | 21 × 39            |
| 1400                    |                                   | 18 × 39 |                    |
| 1500                    | 16 × 35                           |         |                    |
| 1700                    | 18 × 30                           |         |                    |
| 1800                    | 16 × 39                           |         | 21 × 49            |
| 1900                    | 20 × 29                           |         |                    |
| 2000                    |                                   | 21 × 39 |                    |
| 2200                    | 18 × 39                           |         |                    |
| 2700                    |                                   | 21 × 49 |                    |
| 3300                    | 21 × 39                           |         |                    |
| 4500                    | 21 × 49                           |         |                    |

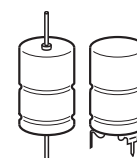
**Case dimensions and ordering codes**

| $C_R$<br>120 Hz<br>20 °C<br>$\mu\text{F}$ | Case<br>dimensions<br>$d \times l$<br>mm | Ordering code<br>Axial pallet | Ordering code<br>Axial reel | Ordering code<br>Soldering star |
|---|--|-------------------------------|-----------------------------|---------------------------------|
| <b><math>V_R = 25 \text{ V DC}</math></b> |  |                               |                             |                                 |
| 1000                                      | 16 × 25                                  | B41689A5108Q001               | B41689A5108Q003             | B41789A5108Q001                 |
| 1000 ▽                                    | 16 × 25                                  | B41689K5108Q001               | B41689K5108Q003             | B41789K5108Q001                 |
| 1200                                      | 18 × 25                                  | B41689A5128Q001               |                             | B41789A5128Q001                 |
| 1200 ▽                                    | 18 × 25                                  | B41689K5128Q001               |                             | B41789K5128Q001                 |
| 1300                                      | 16 × 30                                  | B41689A5138Q001               | B41689A5138Q003             | B41789A5138Q001                 |
| 1300 ▽                                    | 16 × 30                                  | B41689K5138Q001               | B41689K5138Q003             | B41789K5138Q001                 |
| 1500                                      | 16 × 35                                  | B41689A5158Q001               | B41689A5158Q003             | B41789A5158Q001                 |
| 1500 ▽                                    | 16 × 35                                  | B41689K5158Q001               | B41689K5158Q003             | B41789K5158Q001                 |
| 1700                                      | 18 × 30                                  | B41689A5178Q001               |                             | B41789A5178Q001                 |
| 1700 ▽                                    | 18 × 30                                  | B41689K5178Q001               |                             | B41789K5178Q001                 |
| 1800                                      | 16 × 39                                  | B41689A5188Q001               | B41689A5188Q003             | B41789A5188Q001                 |
| 1800 ▽                                    | 16 × 39                                  | B41689K5188Q001               | B41689K5188Q003             | B41789K5188Q001                 |
| 1900                                      | 20 × 29                                  | B41689A5198Q001               |                             |                                 |
| 1900 ▽                                    | 20 × 29                                  | B41689K5198Q001               |                             |                                 |
| 2200                                      | 18 × 39                                  | B41689A5228Q001               |                             | B41789A5228Q001                 |
| 2200 ▽                                    | 18 × 39                                  | B41689K5228Q001               |                             | B41789K5228Q001                 |
| 3300                                      | 21 × 39                                  | B41689A5338Q001               |                             | B41789A5338Q001                 |
| 3300 ▽                                    | 21 × 39                                  | B41689K5338Q001               |                             | B41789K5338Q001                 |
| 4500                                      | 21 × 49                                  | B41689A5458Q001               |                             | B41789A5458Q001                 |
| 4500 ▽                                    | 21 × 49                                  | B41689K5458Q001               |                             | B41789K5458Q001                 |

▽ Increased ripple current due to optimized thermal design

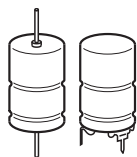
**B41689, B41789**
**Very high ripple current – up to 150 °C**
**Case dimensions and ordering codes**

| $C_R$<br>120 Hz<br>20 °C<br>$\mu\text{F}$ | Case<br>dimensions<br>$d \times l$<br>mm | Ordering code<br>Axial pallet | Ordering code<br>Axial reel | Ordering code<br>Soldering star |
|---|--|-------------------------------|-----------------------------|---------------------------------|
| $V_R = 40 \text{ V DC}$                   |  |                               |                             |                                 |
| 560                                       | 16 × 25                                  | B41689A7567Q001               | B41689A7567Q003             | B41789A7567Q001                 |
| 560 ▽                                     | 16 × 25                                  | B41689K7567Q001               | B41689K7567Q003             | B41789K7567Q001                 |
| 680                                       | 18 × 25                                  | B41689A7687Q001               |                             | B41789A7687Q001                 |
| 680 ▽                                     | 18 × 25                                  | B41689K7687Q001               |                             | B41789K7687Q001                 |
| 720                                       | 16 × 30                                  | B41689A7727Q001               | B41689A7727Q003             | B41789A7727Q001                 |
| 720 ▽                                     | 16 × 30                                  | B41689K7727Q001               | B41689K7727Q003             | B41789K7727Q001                 |
| 820                                       | 16 × 35                                  | B41689A7827Q001               | B41689A7827Q003             | B41789A7827Q001                 |
| 820 ▽                                     | 16 × 35                                  | B41689K7827Q001               | B41689K7827Q003             | B41789K7827Q001                 |
| 900                                       | 18 × 30                                  | B41689A7907Q001               |                             | B41789A7907Q001                 |
| 900 ▽                                     | 18 × 30                                  | B41689K7907Q001               |                             | B41789K7907Q001                 |
| 1000                                      | 16 × 39                                  | B41689A7108Q001               | B41689A7108Q003             | B41789A7108Q001                 |
| 1000 ▽                                    | 16 × 39                                  | B41689K7108Q001               | B41689K7108Q003             | B41789K7108Q001                 |
| 1200                                      | 20 × 29                                  | B41689A7128Q001               |                             |                                 |
| 1200 ▽                                    | 20 × 29                                  | B41689K7128Q001               |                             |                                 |
| 1400                                      | 18 × 39                                  | B41689A7148Q001               |                             | B41789A7148Q001                 |
| 1400 ▽                                    | 18 × 39                                  | B41689K7148Q001               |                             | B41789K7148Q001                 |
| 2000                                      | 21 × 39                                  | B41689A7208Q001               |                             | B41789A7208Q001                 |
| 2000 ▽                                    | 21 × 39                                  | B41689K7208Q001               |                             | B41789K7208Q001                 |
| 2700                                      | 21 × 49                                  | B41689A7278Q001               |                             | B41789A7278Q001                 |
| 2700 ▽                                    | 21 × 49                                  | B41689K7278Q001               |                             | B41789K7278Q001                 |

▽ Increased ripple current due to optimized thermal design

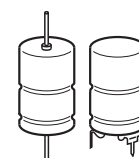

**Case dimensions and ordering codes**

| $C_R$<br>120 Hz<br>20 °C<br>$\mu\text{F}$ | Case<br>dimensions<br>$d \times l$<br>mm | Ordering code<br>Axial pallet | Ordering code<br>Axial reel | Ordering code<br>Soldering star |
|---|--|-------------------------------|-----------------------------|---------------------------------|
| $V_R = 63 \text{ V DC}$                   |  |                               |                             |                                 |
| 360                                       | 16 × 25                                  | B41689B8367Q001               | B41689B8367Q003             | B41789B8367Q001                 |
| 360 ▽                                     | 16 × 25                                  | B41689L8367Q001               | B41689L8367Q003             | B41789L8367Q001                 |
| 470                                       | 18 × 25                                  | B41689B8477Q001               |                             | B41789B8477Q001                 |
| 470 ▽                                     | 18 × 25                                  | B41689L8477Q001               |                             | B41789L8477Q001                 |
| 510                                       | 16 × 30                                  | B41689B8517Q001               | B41689B8517Q003             | B41789B8517Q001                 |
| 510 ▽                                     | 16 × 30                                  | B41689L8517Q001               | B41689L8517Q003             | B41789L8517Q001                 |
| 620                                       | 16 × 35                                  | B41689B8627Q001               | B41689B8627Q003             | B41789B8627Q001                 |
| 620                                       | 18 × 30                                  | B41689C8627Q001               |                             | B41789C8627Q001                 |
| 620 ▽                                     | 16 × 35                                  | B41689L8627Q001               | B41689L8627Q003             | B41789L8627Q001                 |
| 620 ▽                                     | 18 × 30                                  | B41689M8627Q001               |                             | B41789M8627Q001                 |
| 750                                       | 16 × 39                                  | B41689B8757Q001               | B41689B8757Q003             | B41789B8757Q001                 |
| 750 ▽                                     | 16 × 39                                  | B41689L8757Q001               | B41689L8757Q003             | B41789L8757Q001                 |
| 820                                       | 18 × 35                                  | B41689B8827Q001               |                             | B41789B8827Q001                 |
| 820 ▽                                     | 18 × 35                                  | B41689L8827Q001               |                             | B41789L8827Q001                 |
| 910                                       | 18 × 39                                  | B41689B8917Q001               |                             | B41789B8917Q001                 |
| 910                                       | 21 × 30                                  | B41689C8917Q001               |                             | B41789C8917Q001                 |
| 910 ▽                                     | 18 × 39                                  | B41689L8917Q001               |                             | B41789L8917Q001                 |
| 910 ▽                                     | 21 × 30                                  | B41689M8917Q001               |                             | B41789M8917Q001                 |
| 1100                                      | 21 × 35                                  | B41689B8118Q001               |                             | B41789B8118Q001                 |
| 1100 ▽                                    | 21 × 35                                  | B41689L8118Q001               |                             | B41789L8118Q001                 |
| 1300                                      | 21 × 39                                  | B41689B8138Q001               |                             | B41789B8138Q001                 |
| 1300 ▽                                    | 21 × 39                                  | B41689L8138Q001               |                             | B41789L8138Q001                 |
| 1800                                      | 21 × 49                                  | B41689B8188Q001               |                             | B41789B8188Q001                 |
| 1800 ▽                                    | 21 × 49                                  | B41689L8188Q001               |                             | B41789L8188Q001                 |

▽ Increased ripple current due to optimized thermal design

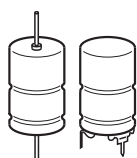
**B41689, B41789**
**Very high ripple current – up to 150 °C**
**Technical data**

| $C_R$                             | Case dimensions | $ESR_{max}$<br>100 Hz | $ESR_{max}$<br>100 Hz | $ESR_{max}$<br>10 kHz | $Z_{max}$<br>100 kHz | $I_{AC,max}^{1)}$<br>10 kHz | $I_{AC,max}$<br>10 kHz | $I_{AC,R}$<br>10 kHz | $I_{AC,max}$<br>10 kHz |
|-----------------------------------|-----------------|-----------------------|-----------------------|-----------------------|----------------------|-----------------------------|------------------------|----------------------|------------------------|
| 120 Hz                            | $d \times l$    | 20 °C                 | -40 °C                | 20 °C                 | 20 °C                | $T_C$ 125 °C                | 125 °C                 | 125 °C               | 150 °C                 |
| $\mu F$                           | mm              | m $\Omega$            | m $\Omega$            | m $\Omega$            | m $\Omega$           | A                           | A                      | A                    | A                      |
| <b><math>V_R = 25</math> V DC</b> |                 |                       |                       |                       |                      |                             |                        |                      |                        |
| 1000                              | 16 × 25         | 98                    | 565                   | 53                    | 50                   | 9.2                         | 5.7                    | 3.5                  | 1.7                    |
| 1000 ▽                            | 16 × 25         | 98                    | 565                   | 53                    | 50                   | 10.1                        | 6.0                    | 3.6                  | 1.8                    |
| 1200                              | 18 × 25         | 80                    | 470                   | 43                    | 41                   | 11.1                        | 6.9                    | 4.2                  | 2.1                    |
| 1200 ▽                            | 18 × 25         | 80                    | 470                   | 43                    | 41                   | 12.2                        | 7.2                    | 4.4                  | 2.2                    |
| 1300                              | 16 × 30         | 75                    | 435                   | 41                    | 39                   | 11.4                        | 7.1                    | 4.3                  | 2.2                    |
| 1300 ▽                            | 16 × 30         | 75                    | 435                   | 41                    | 39                   | 12.5                        | 7.4                    | 4.5                  | 2.2                    |
| 1500                              | 16 × 35         | 65                    | 377                   | 35                    | 34                   | 13.3                        | 8.3                    | 5.0                  | 2.5                    |
| 1500 ▽                            | 16 × 35         | 65                    | 377                   | 35                    | 34                   | 14.6                        | 8.6                    | 5.2                  | 2.6                    |
| 1700                              | 18 × 30         | 57                    | 332                   | 31                    | 29                   | 14.1                        | 8.8                    | 5.3                  | 2.7                    |
| 1700 ▽                            | 18 × 30         | 57                    | 332                   | 31                    | 29                   | 15.5                        | 9.1                    | 5.5                  | 2.8                    |
| 1800                              | 16 × 39         | 55                    | 314                   | 30                    | 28                   | 15.1                        | 9.4                    | 5.7                  | 2.9                    |
| 1800 ▽                            | 16 × 39         | 55                    | 314                   | 30                    | 28                   | 16.6                        | 9.8                    | 5.9                  | 3.0                    |
| 1900                              | 20 × 29         | 52                    | 297                   | 28                    | 27                   | 14.5                        | 9.1                    | 5.5                  | 2.7                    |
| 1900 ▽                            | 20 × 29         | 52                    | 297                   | 28                    | 27                   | 16.0                        | 9.5                    | 5.7                  | 2.9                    |
| 2200                              | 18 × 39         | 44                    | 257                   | 24                    | 23                   | 18.3                        | 11.4                   | 6.9                  | 3.4                    |
| 2200 ▽                            | 18 × 39         | 44                    | 257                   | 24                    | 23                   | 20.1                        | 11.8                   | 7.2                  | 3.6                    |
| 3300                              | 21 × 39         | 31                    | 172                   | 17                    | 16                   | 21.0                        | 13.1                   | 7.9                  | 4.0                    |
| 3300 ▽                            | 21 × 39         | 31                    | 172                   | 17                    | 16                   | 23.2                        | 13.6                   | 8.3                  | 4.1                    |
| 4500                              | 21 × 49         | 23                    | 126                   | 13                    | 12                   | 26.5                        | 16.5                   | 10.0                 | 5.0                    |
| 4500 ▽                            | 21 × 49         | 23                    | 126                   | 13                    | 12                   | 29.2                        | 17.2                   | 10.4                 | 5.2                    |

▽ Increased ripple current due to optimized thermal design

1) Maximum ripple current at 125 °C capacitor case temperature  $T_C$  (measured at aluminum case surface), when mounted to a heat sink. Further details available upon request.

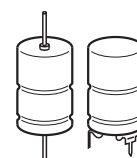
**Technical data**

| $C_R$                             | Case dimensions | $ESR_{max}$<br>100 Hz | $ESR_{max}$<br>100 Hz | $ESR_{max}$<br>10 kHz | $Z_{max}$<br>100 kHz | $I_{AC,max}^{2)}$<br>10 kHz | $I_{AC,max}$<br>10 kHz | $I_{AC,R}$<br>10 kHz | $I_{AC,max}$<br>10 kHz |
|-----------------------------------|-----------------|-----------------------|-----------------------|-----------------------|----------------------|-----------------------------|------------------------|----------------------|------------------------|
| 120 Hz                            | $d \times l$    | 20 °C                 | -40 °C                | 20 °C                 | 20 °C                | $T_C$ 125 °C                | 125 °C                 | 125 °C               | 150 °C                 |
| $\mu F$                           | mm              | m $\Omega$            | m $\Omega$            | m $\Omega$            | m $\Omega$           | A                           | A                      | A                    | A                      |
| <b><math>V_R = 40</math> V DC</b> |                 |                       |                       |                       |                      |                             |                        |                      |                        |
| 560                               | 16 × 25         | 129                   | 587                   | 53                    | 50                   | 9.2                         | 5.7                    | 3.5                  | 1.7                    |
| 560 ▽                             | 16 × 25         | 129                   | 587                   | 53                    | 50                   | 10.1                        | 6.0                    | 3.6                  | 1.8                    |
| 680                               | 18 × 25         | 105                   | 483                   | 43                    | 41                   | 11.1                        | 6.9                    | 4.2                  | 2.1                    |
| 680 ▽                             | 18 × 25         | 105                   | 483                   | 43                    | 41                   | 12.3                        | 7.2                    | 4.4                  | 2.2                    |
| 720                               | 16 × 30         | 100                   | 457                   | 42                    | 39                   | 11.4                        | 7.1                    | 4.3                  | 2.1                    |
| 720 ▽                             | 16 × 30         | 100                   | 457                   | 42                    | 39                   | 12.5                        | 7.4                    | 4.5                  | 2.2                    |
| 820                               | 16 × 35         | 88                    | 401                   | 36                    | 34                   | 13.2                        | 8.2                    | 5.0                  | 2.5                    |
| 820 ▽                             | 16 × 35         | 88                    | 401                   | 36                    | 34                   | 14.5                        | 8.6                    | 5.2                  | 2.6                    |
| 900                               | 18 × 30         | 80                    | 365                   | 33                    | 31                   | 13.9                        | 8.6                    | 5.2                  | 2.6                    |
| 900 ▽                             | 18 × 30         | 80                    | 365                   | 33                    | 31                   | 15.2                        | 9.0                    | 5.4                  | 2.7                    |
| 1000                              | 16 × 39         | 73                    | 329                   | 30                    | 29                   | 15.1                        | 9.4                    | 5.7                  | 2.8                    |
| 1000 ▽                            | 16 × 39         | 73                    | 329                   | 30                    | 29                   | 16.6                        | 9.8                    | 5.9                  | 3.0                    |
| 1200                              | 20 × 29         | 61                    | 274                   | 26                    | 24                   | 14.9                        | 9.3                    | 5.6                  | 2.8                    |
| 1200 ▽                            | 20 × 29         | 61                    | 274                   | 26                    | 24                   | 16.5                        | 9.7                    | 5.9                  | 2.9                    |
| 1400                              | 18 × 39         | 52                    | 235                   | 22                    | 20                   | 18.9                        | 11.8                   | 7.1                  | 3.6                    |
| 1400 ▽                            | 18 × 39         | 52                    | 235                   | 22                    | 20                   | 20.8                        | 12.2                   | 7.4                  | 3.7                    |
| 2000                              | 21 × 39         | 38                    | 165                   | 16                    | 16                   | 21.3                        | 13.2                   | 8.0                  | 4.0                    |
| 2000 ▽                            | 21 × 39         | 38                    | 165                   | 16                    | 16                   | 23.4                        | 13.8                   | 8.4                  | 4.2                    |
| 2700                              | 21 × 49         | 28                    | 123                   | 12                    | 12                   | 26.8                        | 16.7                   | 10.1                 | 5.0                    |
| 2700 ▽                            | 21 × 49         | 28                    | 123                   | 12                    | 12                   | 29.5                        | 17.4                   | 10.5                 | 5.3                    |

▽ Increased ripple current due to optimized thermal design

2) Maximum ripple current at 125 °C capacitor case temperature  $T_C$  (measured at aluminum case surface), when mounted to a heat sink. Further details available upon request.

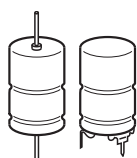

**B41689, B41789**
**Very high ripple current – up to 150 °C**
**Technical data**

| $C_R$                             | Case dimensions | $ESR_{max}$<br>100 Hz | $ESR_{max}$<br>100 Hz | $ESR_{max}$<br>10 kHz | $Z_{max}$<br>100 kHz | $I_{AC,max}^{3)}$<br>10 kHz | $I_{AC,max}$<br>10 kHz | $I_{AC,R}$<br>10 kHz | $I_{AC,max}$<br>10 kHz |
|-----------------------------------|-----------------|-----------------------|-----------------------|-----------------------|----------------------|-----------------------------|------------------------|----------------------|------------------------|
| 120 Hz                            | $d \times l$    | 20 °C                 | -40 °C                | 20 °C                 | 20 °C                | $T_C$ 125 °C                | 125 °C                 | 125 °C               | 150 °C                 |
| $\mu F$                           | mm              | m $\Omega$            | m $\Omega$            | m $\Omega$            | m $\Omega$           | A                           | A                      | A                    | A                      |
| <b><math>V_R = 63</math> V DC</b> |                 |                       |                       |                       |                      |                             |                        |                      |                        |
| 360                               | 16 × 25         | 173                   | 652                   | 58                    | 55                   | 8.9                         | 5.1                    | 3.2                  | 1.6                    |
| 360 ▽                             | 16 × 25         | 173                   | 652                   | 58                    | 55                   | 9.2                         | 5.3                    | 3.3                  | 1.6                    |
| 470                               | 18 × 25         | 132                   | 499                   | 43                    | 41                   | 11.1                        | 6.3                    | 4.0                  | 2.0                    |
| 470 ▽                             | 18 × 25         | 132                   | 499                   | 43                    | 41                   | 11.4                        | 6.6                    | 4.1                  | 2.1                    |
| 510                               | 16 × 30         | 124                   | 461                   | 42                    | 40                   | 11.2                        | 6.4                    | 4.0                  | 2.0                    |
| 510 ▽                             | 16 × 30         | 124                   | 461                   | 42                    | 40                   | 11.6                        | 6.7                    | 4.2                  | 2.1                    |
| 620                               | 16 × 35         | 102                   | 379                   | 34                    | 33                   | 13.4                        | 7.6                    | 4.8                  | 2.4                    |
| 620                               | 18 × 30         | 100                   | 379                   | 33                    | 32                   | 13.8                        | 7.9                    | 4.9                  | 2.5                    |
| 620 ▽                             | 16 × 35         | 102                   | 379                   | 34                    | 33                   | 13.8                        | 7.9                    | 5.0                  | 2.5                    |
| 620 ▽                             | 18 × 30         | 100                   | 379                   | 33                    | 32                   | 14.2                        | 8.2                    | 5.1                  | 2.6                    |
| 750                               | 16 × 39         | 84                    | 314                   | 29                    | 27                   | 15.2                        | 8.7                    | 5.5                  | 2.7                    |
| 750 ▽                             | 16 × 39         | 84                    | 314                   | 29                    | 27                   | 15.8                        | 9.0                    | 5.6                  | 2.8                    |
| 820                               | 18 × 35         | 76                    | 287                   | 26                    | 24                   | 16.6                        | 9.5                    | 6.0                  | 3.0                    |
| 820 ▽                             | 18 × 35         | 76                    | 287                   | 26                    | 24                   | 17.2                        | 9.9                    | 6.2                  | 3.1                    |
| 910                               | 18 × 39         | 69                    | 258                   | 23                    | 22                   | 18.6                        | 10.6                   | 6.7                  | 3.3                    |
| 910                               | 21 × 30         | 71                    | 259                   | 25                    | 24                   | 16.1                        | 9.2                    | 5.8                  | 2.9                    |
| 910 ▽                             | 18 × 39         | 69                    | 258                   | 23                    | 22                   | 19.2                        | 11.0                   | 6.9                  | 3.4                    |
| 910 ▽                             | 21 × 30         | 71                    | 259                   | 25                    | 24                   | 16.6                        | 9.5                    | 6.0                  | 3.0                    |
| 1100                              | 21 × 35         | 58                    | 215                   | 21                    | 20                   | 19.0                        | 10.8                   | 6.8                  | 3.4                    |
| 1100 ▽                            | 21 × 35         | 58                    | 215                   | 21                    | 20                   | 19.7                        | 11.2                   | 7.0                  | 3.5                    |
| 1300                              | 21 × 39         | 50                    | 182                   | 18                    | 17                   | 21.5                        | 12.3                   | 7.7                  | 3.9                    |
| 1300 ▽                            | 21 × 39         | 50                    | 182                   | 18                    | 17                   | 22.3                        | 12.7                   | 8.0                  | 4.0                    |
| 1800                              | 21 × 49         | 36                    | 132                   | 13                    | 13                   | 27.3                        | 15.6                   | 9.8                  | 4.9                    |
| 1800 ▽                            | 21 × 49         | 36                    | 132                   | 13                    | 13                   | 28.2                        | 16.0                   | 10.0                 | 5.0                    |

▽ Increased ripple current due to optimized thermal design

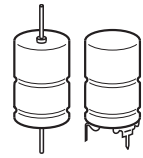
 3) Maximum ripple current at 125 °C capacitor case temperature  $T_C$  (measured at aluminum case surface), when mounted to a heat sink. Further details available upon request.

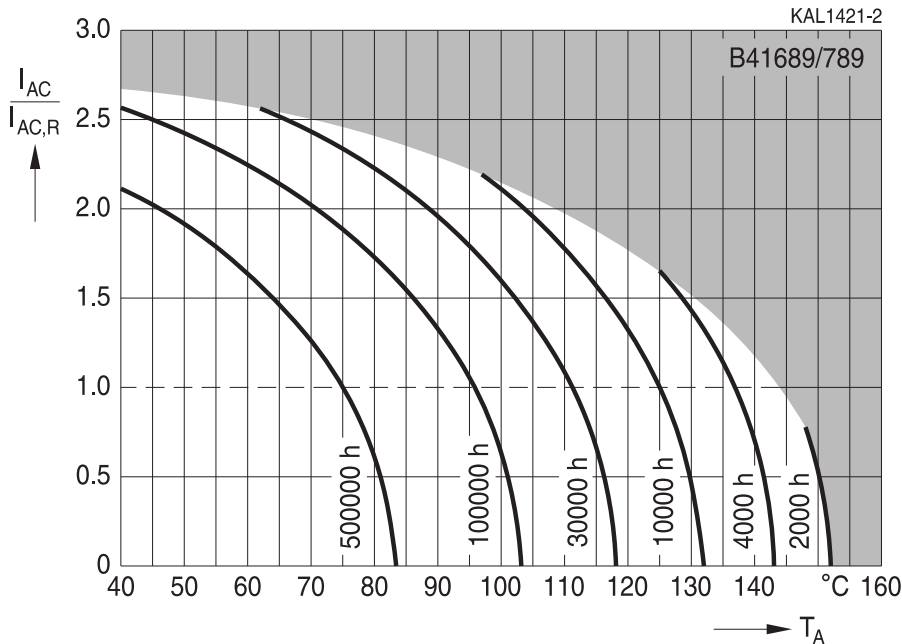
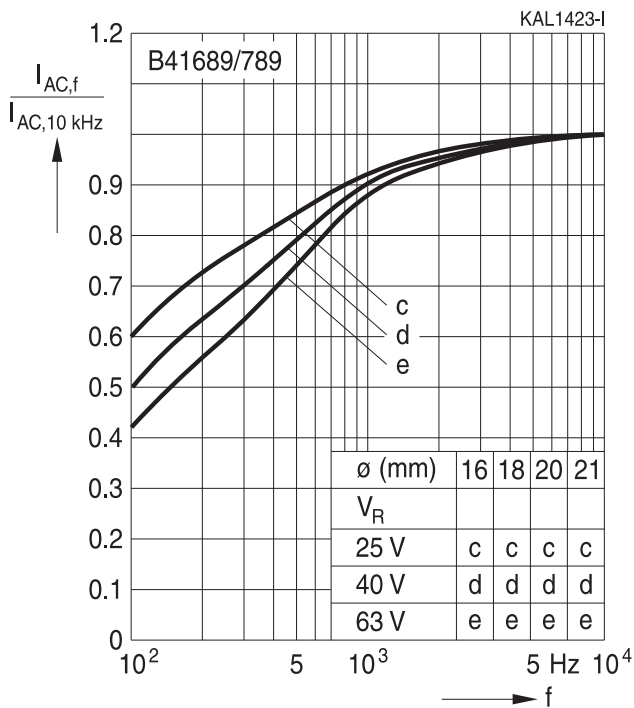
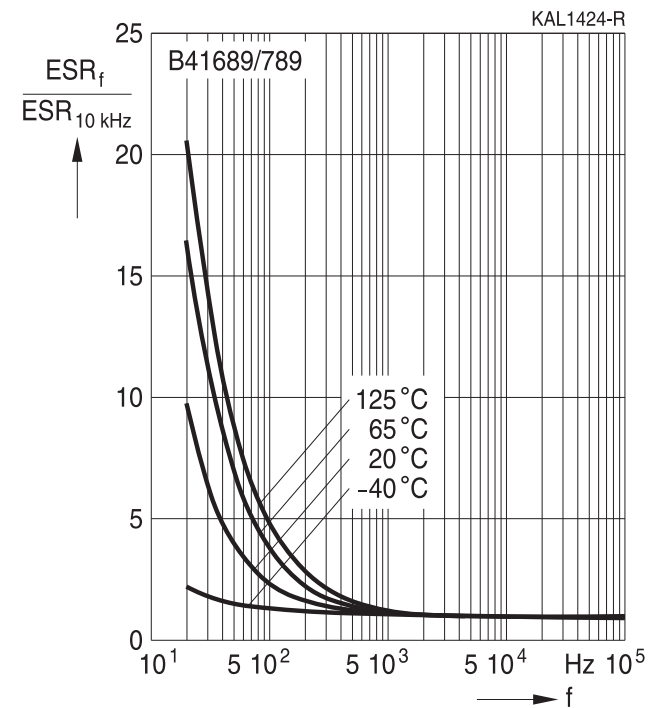
**Useful life<sup>1)</sup>**

 depending on ambient temperature  $T_A$  under ripple current operating conditions at  $V_R$ 

**Frequency factor of permissible ripple current  $I_{AC}$  versus frequency  $f$** 

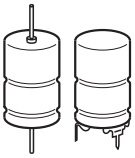
**Frequency characteristics of ESR**  
 Typical behavior

1) Refer to chapter "General technical information, 5 Useful life" on how to interpret useful life.



**B41689, B41789**

**Very high ripple current – up to 150 °C**

**Equivalent series resistance ESR  
versus frequency f**

Typical behavior for 820  $\mu$ F/63 V

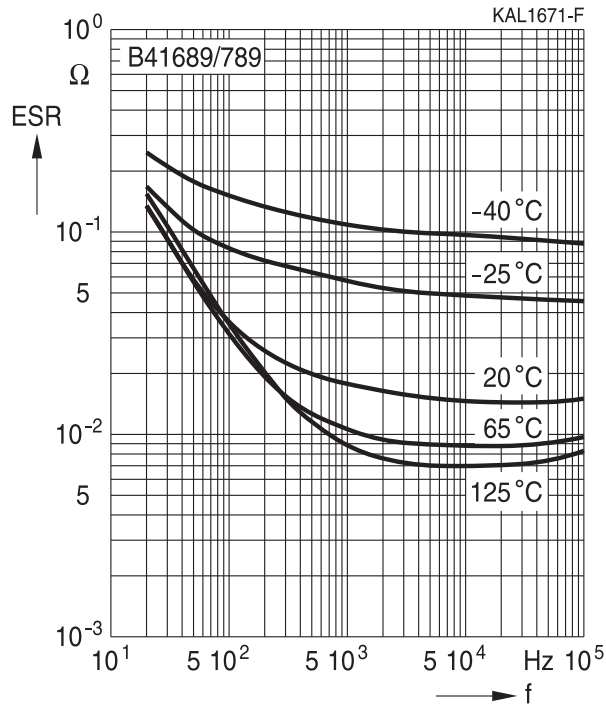

**Impedance Z  
versus frequency f**

Typical behavior for 820  $\mu$ F/63 V

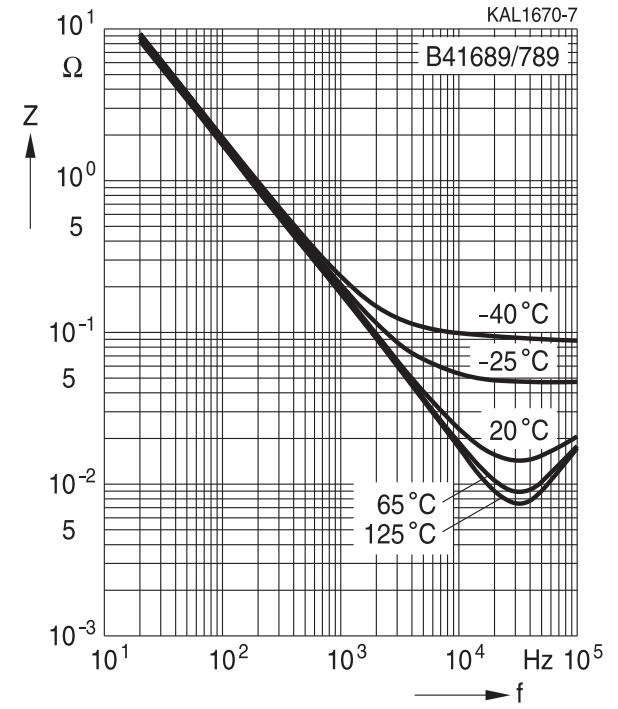

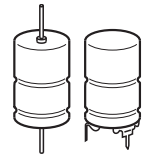

## Cautions and warnings

### Personal safety

The electrolytes used have been optimized both with a view to the intended application and with regard to health and environmental compatibility. They do not contain any solvents that are detrimental to health, e.g. dimethyl formamide (DMF) or dimethyl acetamide (DMAC). Furthermore, some of the high-voltage electrolytes used are self-extinguishing.

As far as possible, we do not use any dangerous chemicals or compounds to produce operating electrolytes, although in exceptional cases, such materials must be used in order to achieve specific physical and electrical properties because no alternative materials are currently known. We do, however, restrict the amount of dangerous materials used in our products to an absolute minimum.

Materials and chemicals used in our aluminum electrolytic capacitors are continuously adapted in compliance with the TDK Electronics Corporate Environmental Policy and the latest EU regulations and guidelines such as RoHS, REACH/SVHC, GADSL, and ELV.

MDS (Material Data Sheets) are available on our website for all types listed in the data book. MDS for customer specific capacitors are available upon request.

MSDS (Material Safety Data Sheets) are available for our electrolytes upon request.

Nevertheless, the following rules should be observed when handling aluminum electrolytic capacitors: No electrolyte should come into contact with eyes or skin. If electrolyte does come into contact with the skin, wash the affected areas immediately with running water. If the eyes are affected, rinse them for 10 minutes with plenty of water. If symptoms persist, seek medical treatment. Avoid inhaling electrolyte vapor or mists. Workplaces and other affected areas should be well ventilated. Clothing that has been contaminated by electrolyte must be changed and rinsed in water.

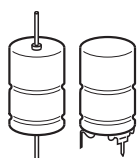

**B41689, B41789**

**Very high ripple current – up to 150 °C**

## Product safety

The table below summarizes the safety instructions that must be observed without fail. A detailed description can be found in the relevant sections of separate file chapter "General technical information".

| Topic  | Safety information  | Reference chapter "General technical information"                |
|--|---|--|
| Polarity                                       | Make sure that polar capacitors are connected with the right polarity.  | 1<br>"Basic construction of aluminum electrolytic capacitors"    |
| Reverse voltage                                | Voltages of opposite polarity should be prevented by connecting a diode.  | 3.1.6<br>"Reverse voltage"                                       |
| Mounting position of screw-terminal capacitors | Screw terminal capacitors must not be mounted with terminals facing down unless otherwise specified.  | 11.1.<br>"Mounting positions of capacitors with screw terminals" |
| Robustness of terminals                        | The following maximum tightening torques must not be exceeded when connecting screw terminals:<br>M5: 2.5 Nm<br>M6: 4.0 Nm  | 11.3<br>"Mounting torques"                                       |
| Mounting of single-ended capacitors            | The internal structure of single-ended capacitors might be damaged if excessive force is applied to the lead wires.<br>Avoid any compressive, tensile or flexural stress.<br>Do not move the capacitor after soldering to PC board.<br>Do not pick up the PC board by the soldered capacitor.<br>Do not insert the capacitor on the PC board with a hole space different to the lead space specified. | 11.4<br>"Mounting considerations for single-ended capacitors"    |
| Soldering                                      | Do not exceed the specified time or temperature limits during soldering.  | 11.5<br>"Soldering"  |
| Soldering, cleaning agents                     | Do not allow halogenated hydrocarbons to come into contact with aluminum electrolytic capacitors.   | 11.6<br>"Cleaning agents"  |
| Upper category temperature                     | Do not exceed the upper category temperature.   | 7.2<br>"Maximum permissible operating temperature"               |
| Passive flammability                           | Avoid external energy, e.g. fire.   | 8.1<br>"Passive flammability"                                    |



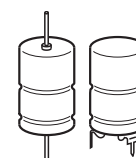

| Topic                                    | Safety information   | Reference chapter "General technical information"   |
|--|--|---|
| Active flammability                      | Avoid overload of the capacitors.  | 8.2<br>"Active flammability"                        |
| Maintenance                              | Make periodic inspections of the capacitors.<br>Before the inspection, make sure that the power supply is turned off and carefully discharge the capacitors.<br>Do not apply excessive mechanical stress to the capacitor terminals when mounting. | 10<br>"Maintenance"                                 |
| Storage                                  | Do not store capacitors at high temperatures or high humidity. Capacitors should be stored at +5 to +35 °C and a relative humidity of ≤ 75%.   | 7.3<br>"Shelf life and storage conditions"          |
|  |  | Reference chapter "Capacitors with screw terminals" |
| Breakdown strength of insulating sleeves | Do not damage the insulating sleeve, especially when ring clips are used for mounting.   | "Screw terminals – accessories"                     |

### Display of ordering codes for TDK Electronics products

The ordering code for one and the same product can be represented differently in data sheets, data books, other publications, on the company website, or in order-related documents such as shipping notes, order confirmations and product labels. The varying representations of the ordering codes are due to different processes employed and do not affect the specifications of the respective products.

Detailed information can be found on the Internet under [www.tdk-electronics.tdk.com/orderingcodes](http://www.tdk-electronics.tdk.com/orderingcodes).

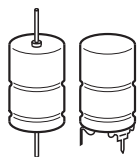

**B41689, B41789**

**Very high ripple current – up to 150 °C**

## Symbols and terms

| Symbol        | English   | German  |
|---------------|---|---|
| C             | Capacitance   | Kapazität   |
| $C_R$         | Rated capacitance   | Nennkapazität   |
| $C_S$         | Series capacitance  | Serienkapazität   |
| $C_{S,T}$     | Series capacitance at temperature T                       | Serienkapazität bei Temperatur T                          |
| $C_f$         | Capacitance at frequency f                                | Kapazität bei Frequenz f                                  |
| d             | Case diameter, nominal dimension                          | Gehäusedurchmesser, Nennmaß                               |
| $d_{max}$     | Maximum case diameter                                     | Maximaler Gehäusedurchmesser                              |
| ESL           | Self-inductance   | Eigeninduktivität   |
| ESR           | Equivalent series resistance                              | Ersatzserienwiderstand                                    |
| $ESR_f$       | Equivalent series resistance at frequency f               | Ersatzserienwiderstand bei Frequenz f                     |
| $ESR_T$       | Equivalent series resistance at temperature T             | Ersatzserienwiderstand bei Temperatur T                   |
| f             | Frequency   | Frequenz  |
| I             | Current   | Strom   |
| $I_{AC}$      | Alternating current (ripple current)                      | Wechselstrom  |
| $I_{AC,RMS}$  | Root-mean-square value of alternating current             | Wechselstrom, Effektivwert                                |
| $I_{AC,f}$    | Ripple current at frequency f                             | Wechselstrom bei Frequenz f                               |
| $I_{AC,max}$  | Maximum permissible ripple current                        | Maximal zulässiger Wechselstrom                           |
| $I_{AC,R}$    | Rated ripple current                                      | Nennwechselstrom  |
| $I_{leak}$    | Leakage current   | Reststrom   |
| $I_{leak,op}$ | Operating leakage current                                 | Betriebsreststrom   |
| l             | Case length, nominal dimension                            | Gehäuselänge, Nennmaß                                     |
| $l_{max}$     | Maximum case length (without terminals and mounting stud) | Maximale Gehäuselänge (ohne Anschlüsse und Gewindebolzen) |
| R             | Resistance  | Widerstand  |
| $R_{ins}$     | Insulation resistance                                     | Isolationswiderstand                                      |
| $R_{symm}$    | Balancing resistance                                      | Symmetrierwiderstand                                      |
| T             | Temperature   | Temperatur  |
| $\Delta T$    | Temperature difference                                    | Temperaturdifferenz                                       |
| $T_A$         | Ambient temperature                                       | Umgebungstemperatur                                       |
| $T_C$         | Case temperature  | Gehäusetemperatur   |
| $T_B$         | Capacitor base temperature                                | Temperatur des Gehäusebodens                              |
| t             | Time  | Zeit  |
| $\Delta t$    | Period  | Zeitraum  |
| $t_b$         | Service life (operating hours)                            | Brauchbarkeitsdauer (Betriebszeit)                        |

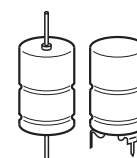

| Symbol        | English                                 | German                               |
|---------------|---|--------------------------------------|
| V             | Voltage                                 | Spannung                             |
| $V_F$         | Forming voltage                         | Formierspannung                      |
| $V_{op}$      | Operating voltage                       | Betriebsspannung                     |
| $V_R$         | Rated voltage, DC voltage               | Nennspannung, Gleichspannung         |
| $V_S$         | Surge voltage                           | Spitzenspannung                      |
| $X_C$         | Capacitive reactance                    | Kapazitiver Blindwiderstand          |
| $X_L$         | Inductive reactance                     | Induktiver Blindwiderstand           |
| Z             | Impedance                               | Scheinwiderstand                     |
| $Z_T$         | Impedance at temperature T              | Scheinwiderstand bei Temperatur T    |
| $\tan \delta$ | Dissipation factor                      | Verlustfaktor                        |
| $\lambda$     | Failure rate                            | Ausfallrate                          |
| $\epsilon_0$  | Absolute permittivity                   | Elektrische Feldkonstante            |
| $\epsilon_r$  | Relative permittivity                   | Dielektrizitätszahl                  |
| $\omega$      | Angular velocity; $2 \cdot \pi \cdot f$ | Kreisfrequenz; $2 \cdot \pi \cdot f$ |

**Note**

All dimensions are given in mm.

## Important notes

The following applies to all products named in this publication:

1. Some parts of this publication contain **statements about the suitability of our products for certain areas of application**. These statements are based on our knowledge of typical requirements that are often placed on our products in the areas of application concerned. We nevertheless expressly point out **that such statements cannot be regarded as binding statements about the suitability of our products for a particular customer application**. As a rule, we are either unfamiliar with individual customer applications or less familiar with them than the customers themselves. For these reasons, it is always ultimately incumbent on the customer to check and decide whether a product with the properties described in the product specification is suitable for use in a particular customer application.
2. We also point out that **in individual cases, a malfunction of electronic components or failure before the end of their usual service life cannot be completely ruled out in the current state of the art, even if they are operated as specified**. In customer applications requiring a very high level of operational safety and especially in customer applications in which the malfunction or failure of an electronic component could endanger human life or health (e.g. in accident prevention or lifesaving systems), it must therefore be ensured by means of suitable design of the customer application or other action taken by the customer (e.g. installation of protective circuitry or redundancy) that no injury or damage is sustained by third parties in the event of malfunction or failure of an electronic component.
3. **The warnings, cautions and product-specific notes must be observed.**
4. In order to satisfy certain technical requirements, **some of the products described in this publication may contain substances subject to restrictions in certain jurisdictions (e.g. because they are classed as hazardous)**. Useful information on this will be found in our Material Data Sheets on the Internet ([www.tdk-electronics.tdk.com/material](http://www.tdk-electronics.tdk.com/material)). Should you have any more detailed questions, please contact our sales offices.
5. We constantly strive to improve our products. Consequently, **the products described in this publication may change from time to time**. The same is true of the corresponding product specifications. Please check therefore to what extent product descriptions and specifications contained in this publication are still applicable before or when you place an order. We also **reserve the right to discontinue production and delivery of products**. Consequently, we cannot guarantee that all products named in this publication will always be available. The aforementioned does not apply in the case of individual agreements deviating from the foregoing for customer-specific products.
6. Unless otherwise agreed in individual contracts, **all orders are subject to our General Terms and Conditions of Supply**.

## Important notes

7. **Our manufacturing sites serving the automotive business apply the IATF 16949 standard.** The IATF certifications confirm our compliance with requirements regarding the quality management system in the automotive industry. Referring to customer requirements and customer specific requirements (“CSR”) TDK always has and will continue to have the policy of respecting individual agreements. Even if IATF 16949 may appear to support the acceptance of unilateral requirements, we hereby like to emphasize that **only requirements mutually agreed upon can and will be implemented in our Quality Management System.** For clarification purposes we like to point out that obligations from IATF 16949 shall only become legally binding if individually agreed upon.
8. The trade names EPCOS, CeraCharge, CeraDiode, CeraLink, CeraPad, CeraPlas, CSMP, CTVS, DeltaCap, DigiSiMic, ExoCore, FilterCap, FormFit, LeaXield, MiniBlue, MiniCell, MKD, MKK, MotorCap, PCC, PhaseCap, PhaseCube, PhaseMod, PhiCap, PowerHap, PQSine, PQvar, SIFERRIT, SIFI, SIKOREL, SilverCap, SIMDAD, SiMic, SIMID, SineFormer, SIOV, ThermoFuse, WindCap are **trademarks registered or pending** in Europe and in other countries. Further information will be found on the Internet at [www.tdk-electronics.tdk.com/trademarks](http://www.tdk-electronics.tdk.com/trademarks).

Release 2018-10