

mikroBASIC PRO for AVR

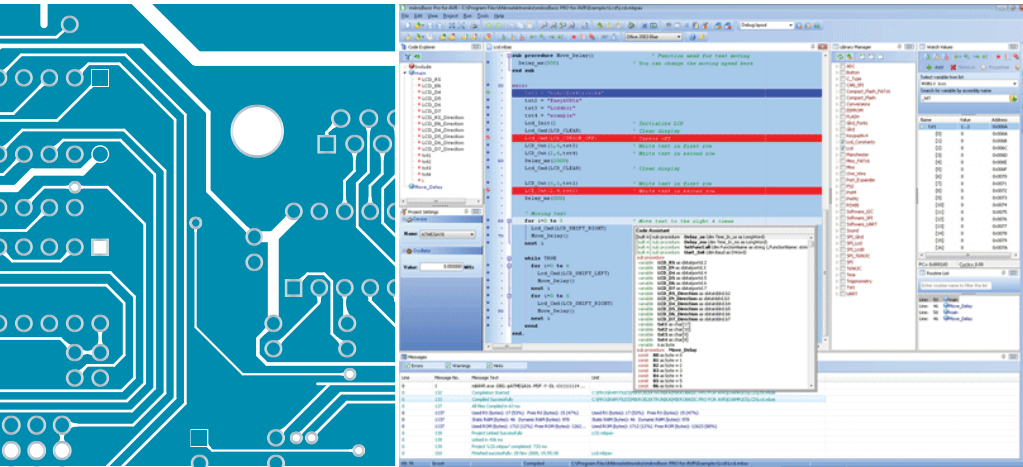

USER MANUAL

Develop your applications quickly and easily with the world's most intuitive mikroBasic PRO for AVR Microcontrollers.

Highly sophisticated IDE provides the power you need with the simplicity of a Windows based point-and-click environment.

With useful implemented tools, many practical code examples, broad set of built-in routines, and a comprehensive Help, mikroBasic PRO for AVR makes a fast and reliable tool, which can satisfy needs of experienced engineers and beginners alike.

March 2009.

Reader's note

DISCLAIMER:

mikroBasic PRO for AVR and this manual are owned by mikroElektronika and are protected by copyright law and international copyright treaty. Therefore, you should treat this manual like any other copyrighted material (e.g., a book). The manual and the compiler may not be copied, partially or as a whole without the written consent from the mikroElektronika. The PDF-edition of the manual can be printed for private or local use, but not for distribution. Modifying the manual or the compiler is strictly prohibited.

HIGH RISK ACTIVITIES:

The *mikroBasic PRO for AVR* compiler is not fault-tolerant and is not designed, manufactured or intended for use or resale as on-line control equipment in hazardous environments requiring fail-safe performance, such as in the operation of nuclear facilities, aircraft navigation or communication systems, air traffic control, direct life support machines, or weapons systems, in which the failure of the Software could lead directly to death, personal injury, or severe physical or environmental damage ("High Risk Activities"). mikroElektronika and its suppliers specifically disclaim any express or implied warranty of fitness for High Risk Activities.

LICENSE AGREEMENT:

By using the *mikroBasic PRO for AVR* compiler, you agree to the terms of this agreement. Only one person may use licensed version of *mikroPascal for 8051* compiler at a time. Copyright © mikroElektronika 2003 - 2009.

This manual covers *mikroBasic PRO for AVR* version 1.2 and the related topics. Newer versions may contain changes without prior notice.

COMPILER BUG REPORTS:

The compiler has been carefully tested and debugged. It is, however, not possible to guarantee a 100 % error free product. If you would like to report a bug, please contact us at the address office@mikroe.com. Please include next information in your bug report:

- Your operating system
- Version of *mikroBasic PRO for AVR*
- Code sample
- Description of a bug

CONTACT US:

mikroElektronika
Voice: + 381 (11) 36 28 830
Fax: + 381 (11) 36 28 831
Web: www.mikroe.com
E-mail: office@mikroe.com

Windows is a Registered trademark of Microsoft Corp. All other trade and/or services marks are the property of the respective owners.

Table of Contents

CHAPTER 1	Introduction
CHAPTER 2	<i>mikroBasic PRO for AVR</i> Environment
CHAPTER 3	<i>mikroBasic PRO for AVR</i> Specifics
CHAPTER 4	AVR Specifics
CHAPTER 5	<i>mikroBasic PRO for AVR</i> Language Reference
CHAPTER 6	<i>mikroBasic PRO for AVR</i> Libraries

CHAPTER 1

Features	2
Where to Start	3
mikroElektronika Associates License Statement and Limited Warranty	4
IMPORTANT - READ CAREFULLY	4
This license statement and limited warranty constitute a legal agree ment (“License Agreement”)	4
LIMITED WARRANTY	5
HIGH RISK ACTIVITIES	6
GENERAL PROVISIONS	6
Technical Support	7
How to Register	8
Who Gets the License Key	8
How to Get License Key	8
After Receiving the License Key	10

CHAPTER 2

IDE Overview	12
Main Menu Options	13
File Menu Options	14
Edit Menu Options	15
Find Text	16
Dialog box	16
Find In Files	17
Go To Line	17
Regular expressions	17
View Menu Options	18
Toolbars	19
File Toolbar	19
Edit Toolbar	19
Advanced Edit Toolbar	20
Find/Replace Toolbar	20
Project Toolbar	21
Build Toolbar	21

Debugger	22
Styles Toolbar	22
Tools Toolbar	23
Project Menu Options	24
Run Menu Options	26
Tools Menu Options	27
Help Menu Options	28
Keyboard Shortcuts	29
IDE Overview	31
Customizing IDE Layout	32
Docking Windows	32
Saving Layout	33
Once you have a	33
Auto Hide	34
Advanced Code Editor	35
Advanced Editor Features	35
Code Assistant	36
Code Folding	37
Parameter Assistant	38
Code Templates (Auto Complete)	38
Auto Correct	38
Spell Checker	39
Bookmarks	39
Goto Line	39
Comment / Uncomment	39
Code Explorer	40
Routine List	41
Project Manager	42
Project Settings Window	43
Library Manager	44
Error Window	46
Statistics	47
Memory Usage Windows	47
RAM Memory	47
Rx Memory Space	47
Data Memory Space	48

Special Function Registers	48
Summarizes all Special Funct	48
General Purpose Registers	49
ROM Memory	49
ROM Memory Usage	49
ROM Memory Allocation	50
Procedures Windows	50
Procedures Size Window	50
Procedures Locations Window	51
HTML Window	51
Integrated Tools	52
USART Terminal	52
ASCII Chart	53
EEPROM Editor	54
7 Segment Display Decoder	55
UDP Terminal	56
Graphic Lcd Bitmap Editor	57
Lcd Custom Character	58
Macro Editor	59
Options	60
Code editor	60
Tools	60
Output settings	61
Regular Expressions	62
Introduction	62
Simple matches	62
Escape sequences	62
Character classes	63
Metacharacters	63
Metacharacters - Line separators	63
Metacharacters - Predefined classes	64
Metacharacters - Word boundaries	64
Metacharacters - Iterators	65
Metacharacters - Alternatives	66
Examples:	66
Metacharacters - Subexpressions	66

Metacharacters - Backreferences	66
mikroBasic PRO for AVR Command Line Options	67
Projects	68
New Project	68
New Project Wizard Steps	69
Customizing Projects	72
Edit Project	72
Managing Project Group	72
Add/Remove Files from Project	72
Project Level Defines	73
Source Files	74
Managing Source Files	74
Creating new source file	74
Opening an existing file	74
Printing an open file	74
Saving file	75
Saving file under a different name	75
Closing file	75
Clean Project Folder	76
Clean Project Folder	76
Compilation	77
Output Files	77
Assembly View	77
Error Messages	78
Compiler Error Messages:	78
Warning Messages:	79
Hint Messages:	79
Software Simulator Overview	80
Watch Window	80
Stopwatch Window	82
RAM Window	83
Software Simulator Options	84
Creating New Library	85
Multiple Library Versions	86

CHAPTER 3

Basic Standard Issues	88
Divergence from the Basic Standard	88
Basic Language Exstensions	88
Predefined Globals and Constants	89
SFRs and related constants	89
Math constants	89
Predefined project level defines	89
Accessing Individual Bits	90
Accessing Individual Bits Of Variables	90
sbit type	90
bit type	91
Interrupts	92
Function Calls from Interrupt	92
Linker Directives	94
Directive absolute	94
Directive org	94
Built-in Routines	95
Lo	96
Hi	96
Higher	96
Highest	97
Inc	97
Dec	97
Delay_us	98
Delay_ms	98
Vdelay_ms	98
Delay_Cyc	99
Clock_KHz	99
Clock_MHz	99
SetFuncCall	100
Code Optimization	101
Constant folding	101
Constant propagation	101
Copy propagation	101
Value numbering	101

"Dead code" elimination	101
Stack allocation	101
Local vars optimization	101
Better code generation and local optimization	101
Types Efficiency	103

CHAPTER 4

Nested Calls Limitations	104
Important notes:	104
AVR Memory Organization	105
Program Memory (ROM)	105
Data Memory	105
Memory Type Specifiers	107
code	107
data	107
rx	107
io	108
sfr	108
register	108
Note:	108

CHAPTER 5

mikroBasic PRO for AVR Language Reference	110
Lexical Elements Overview	111
Whitespace	112
Newline Character	112
Whitespace in Strings	112
Comments	113
Tokens	113
Token Extraction Example	113
Literals	114
Integer Literals	114
Floating Point Literals	114
Character Literals	115

String Literals	115
Keywords	116
Identifiers	117
Case Sensitivity	117
Uniqueness and Scope	117
Identifier Examples	117
Punctuators	118
Brackets	118
Parentheses	118
Comma	118
Colon	119
Dot	119
Program Organization	120
Organization of Main Module	120
Organization of Other Modules	121
Scope and Visibility	123
Scope	123
Visibility	123
Modules	124
Include Clause	124
Main Module	125
Other Modules	125
Interface Section	125
Implementation Section	126
Variables	127
Variables and AVR	127
Constants	128
Labels	129
Symbols	130
Functions and Procedures	131
Functions	131
Calling a function	131
Example	132
Procedures	132
Calling a procedure	132
Example	133

Function Pointers	133
Example:	133
Example:	134
Forward declaration	135
Types	136
Type Categories	136
Simple Types	137
Arrays	138
Array Declaration	138
Constant Arrays	138
Strings	139
Note	139
Pointers	140
@ Operator	140
Structures	141
Structure Member Access	142
Types Conversions	143
Implicit Conversion	143
Promotion	143
Clipping	144
Explicit Conversion	144
Operators	145
Operators Precedence and Associativity	145
Arithmetic Operators	146
Division by Zero	146
Unary Arithmetic Operators	146
Relational Operators	147
Relational Operators in Expressions	147
Bitwise Operators	148
Bitwise Operators Overview	148
Logical Operations on Bit Level	148
The bitwise operators and, or, and xor perform logical oper	148
Unsigned and Conversions	149
Signed and Conversions	149
Bitwise Shift Operators	150
Boolean Operators	150

Expressions	151
Statements	152
Assignment Statements	152
Conditional Statements	153
If Statement	153
Nested if statements	153
Select Case Statement	154
Nested Case Statements	155
Iteration Statements	155
For Statement	156
Endless Loop	156
While Statement	157
Do Statement	158
Jump Statements	158
Break and Continue Statements	159
Break Statement	159
Continue Statement	159
Exit Statement	160
Goto Statement	161
Gosub Statement	162
asm Statement	163
Directives	164
Compiler Directives	164
Directives #DEFINE and #UNDEFINE	164
Directives #IFDEF, #ELSEIF and #ELSE	164
Predefined Flags	165
Linker Directives	166
Directive absolute	166
Directive org	166

CHAPTER 6

Hardware AVR-specific Libraries	168
Miscellaneous Libraries	168
Library Dependencies	169
ADC Library	170

ADC_Read	170
Library Example	170
This example code reads a	170
HW Connection	171
CANSPI Library	172
External dependencies of CANSPI Library	173
Library Routines	173
CANSPISetOperationMode	174
CANSPIGetOperationMode	174
CANSPIInitialize	175
CANSPISetBaudRate	177
CANSPISetMask	178
CANSPISetFilter	179
CANSPIRead	180
CANSPIWrite	181
CANSPI Constants	182
CANSPI_OP_MODE	182
CANSPI_CONFIG_FLAGS	182
CANSPI_TX_MSG_FLAGS	183
CANSPI_RX_MSG_FLAGS	184
CANSPI_MASK	184
CANSPI_FILTER	184
Library Example	185
HW Connection	188
Compact Flash Library	189
External dependencies of Compact Flash Library	190
Library Routines	191
Cf_Init	192
Cf_Detect	193
Cf_Enable	193
Cf_Disable	193
Cf_Read_Init	194
Cf_Read_Byte	194
Cf_Write_Init	195
Cf_Write_Byte	195
Cf_Read_Sector	196

Cf_Write_Sector	196
Cf_Fat_Init	197
Cf_Fat_QuickFormat	197
Cf_Fat_Assign	198
Cf_Fat_Reset	199
Cf_Fat_Read	199
Cf_Fat_Rewrite	200
Cf_Fat_Append	200
Cf_Fat_Delete	200
Cf_Fat_Write	201
Cf_Fat_Set_File_Date	201
Cf_Fat_Get_File_Date	202
Cf_Fat_Get_File_Size	202
Cf_Fat_Get_Swap_File	203
Library Example	205
HW Connection	210
EEPROM Library	211
Library Routines	211
EEPROM_Read	211
EEPROM_Write	212
Library Example	213
Flash Memory Library	214
Library Routines	214
FLASH_Read_Byte	214
FLASH_Read_Bytes	215
FLASH_Read_Word	215
FLASH_Read_Words	216
Library Example	216
Graphic Lcd Library	218
External dependencies of Graphic Lcd Library	218
Library Routines	219
Glcd_Init	220
Glcd_Set_Side	221
Glcd_Set_X	221
Glcd_Set_Page	222
Glcd_Read_Data	222

Glcd_Write_Data	223
Glcd_Fill	223
Glcd_Dot	224
Glcd_Line	224
Glcd_V_Line	225
Glcd_H_Line	225
Glcd_Rectangle	226
Glcd_Box	227
Glcd_Circle	227
Glcd_Set_Font	228
Glcd_Write_Char	229
Glcd_Write_Text	230
Glcd_Image	230
Library Example	231
HW Connection	233
Keypad Library	234
Library Routines	234
Keypad_Init	235
Keypad_Key_Press	235
Keypad_Key_Click	235
Library Example	236
HW Connection	239
Lcd Library	240
External dependencies of Lcd Library	240
Library Routines	241
Lcd_Init	241
Lcd_Out	242
Lcd_Out_Cp	242
Lcd_Chr	243
Lcd_Chr_Cp	243
Lcd_Cmd	244
Available Lcd Commands	244
Library Example	245
Manchester Code Library	247
External dependencies of Manchester Code Library	247
Library Routines	248

Man_Receive_Init	248
Man_Receive	249
Man_Send_Init	249
Man_Send	250
Man_Synchro	250
Man_Break	251
Library Example	252
Connection Example	254
Multi Media Card Library	255
Secure Digital Card	255
External dependencies of MMC Library	255
Library Routines	256
Mmc_Init	257
Mmc_Read_Sector	258
Mmc_Write_Sector	259
Mmc_Read_Cid	260
Mmc_Read_Csd	260
Mmc_Fat_Init	261
Mmc_Fat_QuickFormat	262
Mmc_Fat_Assign	263
Mmc_Fat_Reset	264
Mmc_Fat_Read	265
Mmc_Fat_Rewrite	265
Mmc_Fat_Append	266
Mmc_Fat_Delete	266
Mmc_Fat_Write	267
Mmc_Fat_Set_File_Date	268
Mmc_Fat_Get_File_Date	269
Mmc_Fat_Get_File_Size	270
Mmc_Fat_Get_Swap_File	271
Library Example	273
HW Connection	280
OneWire Library	281
External dependencies of OneWire Library	281
Library Routines	281
Ow_Reset	282

Ow_Read	283
Ow_Write	284
Library Example	285
HW Connection	288
Port Expander Library	289
External dependencies of Port Expander Library	289
Library Routines	289
Expander_Init	290
Expander_Read_Byte	291
Expander_Write_Byte	291
Expander_Read_PortA	292
Expander_Read_PortB	292
Expander_Read_PortAB	293
Expander_Write_PortA	294
Expander_Write_PortB	295
Expander_Write_PortAB	296
Expander_Set_DirectionPortA	297
Expander_Set_DirectionPortB	297
Expander_Set_DirectionPortAB	298
Expander_Set_PullUpsPortA	298
Expander_Set_PullUpsPortB	299
Expander_Set_PullUpsPortAB	299
Library Example	300
HW Connection	301
PS/2 Library	302
External dependencies of PS/2 Library	302
Library Routines	302
Ps2_Config	303
Ps2_Key_Read	304
Special Function Keys	305
Library Example	306
HW Connection	307
PWM Library	308
Library Routines	308
Predefined constants used in PWM library	308
PWM_Init	310

PWM_Set_Duty	311
PWM_Start	311
PWM_Stop	312
PWM1_Init	312
PWM1_Set_Duty	314
PWM1_Start	314
PWM1_Stop	314
Library Example	315
HW Connection	316
PWM 16 bit Library	317
Library Routines	317
Predefined constants used in PWM-16bit library	318
PWM16bit_Init	319
PWM16bit_Change_Duty	321
PWM16bit_Start	322
PWM16bit_Stop	322
Library Example	322
The example changes PWM duty ratio continually	322
HW Connection	324
PWM demonstrati	324
RS-485 Library	325
External dependencies of RS-485 Library	326
Library Routines	326
RS485Master_Init	327
RS485Master_Receive	328
RS485Master_Send	329
RS485Slave_Init	330
RS485Slave_Receive	331
RS485Slave_Send	332
Library Example	332
HW Connection	336
Message format and CRC calculations	337
Software I ² C Library	338
External dependencies of Soft_I2C Library	338
Library Routines	339
Soft_I2C_Init	339

Soft_I2C_Start	340
Soft_I2C_Read	340
Soft_I2C_Write	341
Soft_I2C_Stop	341
Soft_I2C_Break	342
Library Example	343
Software SPI Library	346
External dependencies of Software SPI Library	346
Library Routines	347
Soft_SPI_Init	347
Soft_SPI_Read	348
Soft_SPI_Write	348
Library Example	349
Software UART Library	351
External dependencies of Software UART Library	351
Library Routines	351
Soft_UART_Init	352
Soft_UART_Read	353
Soft_UART_Write	354
Soft_UART_Break	355
Library Example	356
Sound Library	357
External dependencies of Sound Library	357
Library Routines	357
Sound_Init	358
Sound_Play	358
Library Example	359
HW Connection	361
SPI Library	362
Library Routines	362
SPI1_Init	362
SPI1_Init_Advanced	363
SPI1_Read	364
SPI1_Write	364
Library Example	365
HW Connection	366

SPI Ethernet Library	367
External dependencies of SPI Ethernet Library	368
Library Routines	369
Spi_Ethernet_Init	369
Spi_Ethernet_Enable	371
Spi_Ethernet_Disable	372
Spi_Ethernet_doPacket	374
Spi_Ethernet_putByte	375
Spi_Ethernet_putBytes	375
Spi_Ethernet_putConstBytes	376
Spi_Ethernet_putString	376
Spi_Ethernet_putConstString	377
Spi_Ethernet_getByte	377
Spi_Ethernet_getBytes	378
Spi_Ethernet_UserTCP	379
Spi_Ethernet_UserUDP	380
Library Example	381
This code shows h	381
HW Connection	389
SPI Graphic Lcd Library	390
External dependencies of SPI Graphic Lcd Library	390
Library Routines	390
SPI_Glcd_Init	391
SPI_Glcd_Set_Side	392
SPI_Glcd_Set_Page	392
SPI_Glcd_Set_X	393
SPI_Glcd_Read_Data	393
SPI_Glcd_Write_Data	394
SPI_Glcd_Fill	394
SPI_Glcd_Dot	395
SPI_Glcd_Line	395
SPI_Glcd_V_Line	396
SPI_Glcd_H_Line	396
SPI_Glcd_Rectangle	397
SPI_Glcd_Box	398
SPI_Glcd_Circle	398

SPI_Glcd_Set_Font	399
SPI_Glcd_Write_Char	400
SPI_Glcd_Write_Text	401
SPI_Glcd_Image	402
Library Example	402
The example demonstrates how to	402
HW Connection	405
SPI Lcd Library	406
External dependencies of SPI Lcd Library	406
Library Routines	406
SPI_Lcd_Config	407
SPI_Lcd_Out	408
SPI_Lcd_Out_Cp	408
SPI_Lcd_Chrc	409
SPI_Lcd_Chrc_Cp	409
SPI_Lcd_Cmd	410
Available SPI Lcd Commands	410
Library Example	411
HW Connection	412
SPI Lcd8 (8-bit interface) Library	413
External dependencies of SPI Lcd Library	413
Library Routines	413
SPI_Lcd8_Config	414
SPI_Lcd8_Out	415
SPI_Lcd8_Out_Cp	415
SPI_Lcd8_Chrc	416
SPI_Lcd8_Chrc_Cp	416
SPI_Lcd8_Cmd	417
Available SPI Lcd8 Commands	417
Library Example	418
HW Connection	419
SPI T6963C Graphic Lcd Library	420
External dependencies of SPI T6963C Graphic Lcd Library	420
Library Routines	421
SPI_T6963C_Config	422
SPI_T6963C_WriteData	423

SPI_T6963C_WriteCommand	424
SPI_T6963C_SetPtr	424
SPI_T6963C_WaitReady	424
SPI_T6963C_Fill	425
SPI_T6963C_Dot	425
SPI_T6963C_Write_Char	426
SPI_T6963C_Write_Text	427
SPI_T6963C_Line	428
SPI_T6963C_Rectangle	428
SPI_T6963C_Box	429
SPI_T6963C_Circle	429
SPI_T6963C_Image	430
SPI_T6963C_Sprite	430
SPI_T6963C_Set_Cursor	431
SPI_T6963C_ClearBit	431
SPI_T6963C_SetBit	431
SPI_T6963C_NegBit	432
SPI_T6963C_DisplayGrPanel	432
SPI_T6963C_DisplayTxtPanel	432
SPI_T6963C_SetGrPanel	433
SPI_T6963C_SetTxtPanel	433
SPI_T6963C_PanelFill	434
SPI_T6963C_GrFill	434
SPI_T6963C_TxtFill	434
SPI_T6963C_Cursor_Height	435
SPI_T6963C_Graphics	435
SPI_T6963C_Text	435
SPI_T6963C_Cursor	436
SPI_T6963C_Cursor_Blink	436
Library Example	436
The following drawing demo tests advanced routines of the S	436
HW Connection	441
SPI T6963C Graphic Lcd Library	442
External dependencies of T6963C Graphic Lcd Library	443
Library Routines	444
T6963C_Init	445

T6963C_WriteData	446
T6963C_WriteCommand	447
T6963C_SetPtr	447
T6963C_WaitReady	447
T6963C_Fill	448
T6963C_Dot	448
T6963C_Write_Char	449
T6963C_Write_Text	450
T6963C_Line	451
T6963C_Rectangle	451
T6963C_Box	452
T6963C_Circle	452
T6963C_Image	453
T6963C_Sprite	453
T6963C_Set_Cursor	454
T6963C_DisplayGrPanel	454
T6963C_DisplayTxtPanel	454
T6963C_SetGrPanel	455
T6963C_SetTxtPanel	455
T6963C_PanelFill	456
T6963C_GrFill	456
T6963C_TxtFill	456
T6963C_Cursor_Height	457
T6963C_Graphics	457
T6963C_Text	457
T6963C_Cursor	458
T6963C_Cursor_Blink	458
Library Example	458
The following drawing demo tests advanced routines	458
HW Connection	464
TWI Library	465
Library Routines	465
TWI_Init	465
TWI_Busy	465
TWI_Start	466
TWI_Read	466

TWI_Write	466
TWI_Stop	467
TWI_Status	467
TWI_Close	467
Library Example	467
This code demonstrates use of TWI Library proc	467
HW Connection	468
UART Library	469
Library Routines	469
UARTx_Init	470
UARTx_Init_Advanced	471
UARTx_Data_Ready	472
UARTx_Read	472
UARTx_Read_Text	473
UARTx_Write	474
UARTx_Write_Text	474
Library Example	475
HW Connection	475
Button Library	476
External dependencies of Button Library	476
Library Routines	476
Button	476
Conversions Library	478
Library Routines	478
ByteToStr	478
ShortToStr	479
WordToStr	479
IntToStr	480
LongintToStr	480
LongWordToStr	481
FloatToStr	482
Dec2Bcd	483
Bcd2Dec16	483
Dec2Bcd16	484
Math Library	485
Library Functions	485

acos	485
asin	485
atan	486
atan2	486
ceil	486
cos	486
cosh	486
eval_poly	486
exp	487
fabs	487
floor	487
frexp	487
ldexp	487
log	487
log10	487
modf	488
pow	488
sin	488
sinh	488
sqrt	488
tan	488
tanh	488
String Library	489
Library Functions	489
memchr	489
memcmp	490
memcpy	490
memmove	490
memset	491
strcat	491
strchr	491
strcmp	491
strcpy	492
strcspn	492
strlen	492
strncat	492

strncmp	493
strncpy	493
strpbrk	493
strchr	493
strspn	494
strstr	494
Time Library	495
Library Routines	495
Time_dateToEpoch	495
Time_epochToDate	496
Time_dateDiff	496
Library Example	497
TimeStruct type definition	497
Trigonometry Library	498
Library Routines	498
sinE3	498
cosE3	499

CHAPTER

1

Introduction to *mikroBasic PRO for AVR*

The *mikroBasic PRO for AVR* is a powerful, feature-rich development tool for AVR microcontrollers. It is designed to provide the programmer with the easiest possible solution to developing applications for embedded systems, without compromising performance or control.

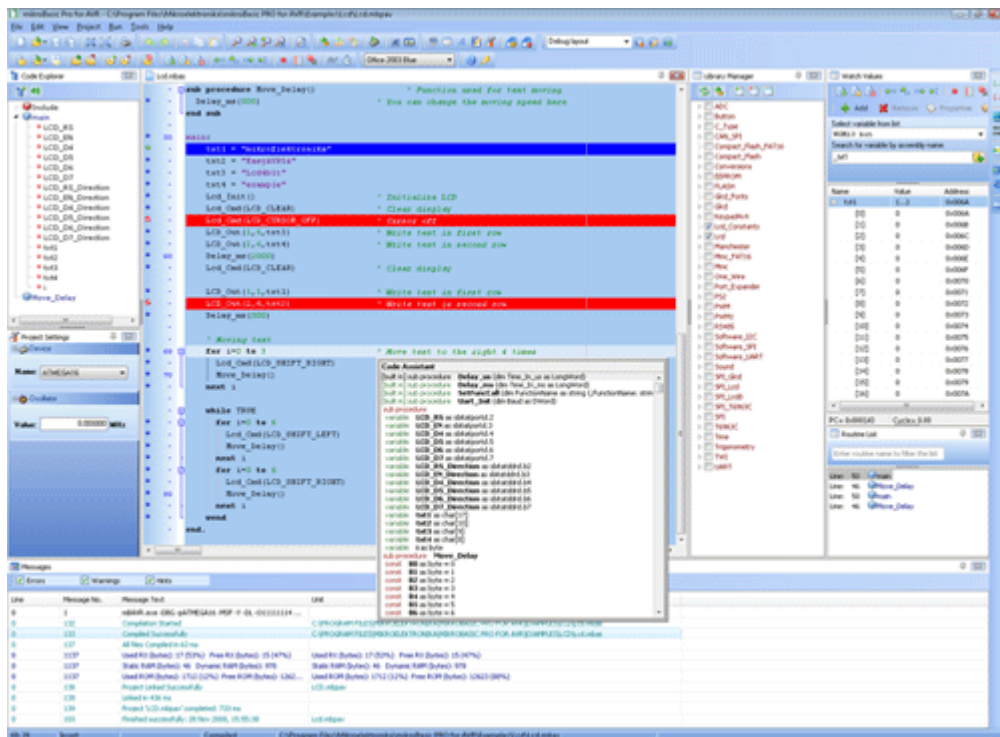

mikroBasic PRO for AVR IDE

Features

mikroBasic PRO for AVR allows you to quickly develop and deploy complex applications:

- Write your Basic source code using the built-in Code Editor (Code and Parameter Assistants, Code Folding, Syntax Highlighting, Spell Checker, Auto Correct, Code Templates, and more.)
- Use included mikroBasic PRO libraries to dramatically speed up the development: data acquisition, memory, displays, conversions, communication etc.
- Monitor your program structure, variables, and functions in the Code Explorer.
- Generate commented, human-readable assembly, and standard HEX compatible with all programmers.
- Inspect program flow and debug executable logic with the integrated Software Simulator.
- Get detailed reports and graphs: RAM and ROM map, code statistics, assembly listing, calling tree, and more.
- mikroBasic PRO for AVR provides plenty of examples to expand, develop, and use as building bricks in your projects. Copy them entirely if you deem fit – that’s why we included them with the compiler.

Where to Start

- In case that you're a beginner in programming AVR microcontrollers, read carefully the AVR Specifics chapter. It might give you some useful pointers on AVR constraints, code portability, and good programming practices.
- If you are experienced in Basic programming, you will probably want to consult mikroBasic PRO for AVR Specifics first. For language issues, you can always refer to the comprehensive Language Reference. A complete list of included libraries is available at mikroBasic PRO for AVR Libraries.
- If you are not very experienced in Basic programming, don't panic! mikroBasic PRO for AVR provides plenty of examples making it easy for you to go quickly. We suggest that you first consult Projects and Source Files, and then start browsing the examples that you're the most interested in.

MIKROELEKTRONIKA ASSOCIATES LICENSE STATEMENT AND LIMITED WARRANTY

IMPORTANT - READ CAREFULLY

This license statement and limited warranty constitute a legal agreement (“License Agreement”) between you (either as an individual or a single entity) and mikroElektronika (“mikroElektronika Associates”) for software product (“Software”) identified above, including any software, media, and accompanying on-line or printed documentation.

BY INSTALLING, COPYING, OR OTHERWISE USING SOFTWARE, YOU AGREE TO BE BOUND BY ALL TERMS AND CONDITIONS OF THE LICENSE AGREEMENT.

Upon your acceptance of the terms and conditions of the License Agreement, mikroElektronika Associates grants you the right to use Software in a way provided below.

This Software is owned by mikroElektronika Associates and is protected by copyright law and international copyright treaty. Therefore, you must treat this Software like any other copyright material (e.g., a book).

You may transfer Software and documentation on a permanent basis provided. You retain no copies and the recipient agrees to the terms of the License Agreement. Except as provided in the License Agreement, you may not transfer, rent, lease, lend, copy, modify, translate, sublicense, time-share or electronically transmit or receive Software, media or documentation. You acknowledge that Software in the source code form remains a confidential trade secret of mikroElektronika Associates and therefore you agree not to modify Software or attempt to reverse engineer, decompile, or disassemble it, except and only to the extent that such activity is expressly permitted by applicable law notwithstanding this limitation.

If you have purchased an upgrade version of Software, it constitutes a single product with the mikroElektronika Associates software that you upgraded. You may use the upgrade version of Software only in accordance with the License Agreement.

LIMITED WARRANTY

Respectfully excepting the Redistributables, which are provided “as is”, without warranty of any kind, mikroElektronika Associates warrants that Software, once updated and properly used, will perform substantially in accordance with the accompanying documentation, and Software media will be free from defects in materials and workmanship, for a period of ninety (90) days from the date of receipt. Any implied warranties on Software are limited to ninety (90) days.

mikroElektronika Associates’ and its suppliers’ entire liability and your exclusive remedy shall be, at mikroElektronika Associates’ option, either (a) return of the price paid, or (b) repair or replacement of Software that does not meet mikroElektronika Associates’ Limited Warranty and which is returned to mikroElektronika Associates with a copy of your receipt. DO NOT RETURN ANY PRODUCT UNTIL YOU HAVE CALLED MIKROELEKTRONIKA ASSOCIATES FIRST AND OBTAINED A RETURN AUTHORIZATION NUMBER. This Limited Warranty is void if failure of Software has resulted from an accident, abuse, or misapplication. Any replacement of Software will be warranted for the rest of the original warranty period or thirty (30) days, whichever is longer.

TO THE MAXIMUM EXTENT PERMITTED BY APPLICABLE LAW, MIKROELEKTRONIKA ASSOCIATES AND ITS SUPPLIERS DISCLAIM ALL OTHER WARRANTIES AND CONDITIONS, EITHER EXPRESSED OR IMPLIED, INCLUDED, BUT NOT LIMITED TO IMPLIED WARRANTIES OF MERCHANTABILITY, FITNESS FOR A PARTICULAR PURPOSE, TITLE, AND NON-INFRINGEMENT, WITH REGARD TO SOFTWARE, AND THE PROVISION OF OR FAILURE TO PROVIDE SUPPORT SERVICES.

IN NO EVENT SHALL MIKROELEKTRONIKA ASSOCIATES OR ITS SUPPLIERS BE LIABLE FOR ANY SPECIAL, INCIDENTAL, INDIRECT, OR CONSEQUENTIAL DAMAGES WHATSOEVER (INCLUDING, WITHOUT LIMITATION, DAMAGES FOR LOSS OF BUSINESS PROFITS AND BUSINESS INFORMATION, BUSINESS INTERRUPTION, OR ANY OTHER PECUNIARY LOSS) ARISING OUT OF THE USE OF OR INABILITY TO USE SOFTWARE PRODUCT OR THE PROVISION OF OR FAILURE TO PROVIDE SUPPORT SERVICES, EVEN IF MIKROELEKTRONIKA ASSOCIATES HAS BEEN ADVISED OF THE POSSIBILITY OF SUCH DAMAGES. IN ANY CASE, MIKROELEKTRONIKA ASSOCIATES’ ENTIRE LIABILITY UNDER ANY PROVISION OF THIS LICENSE AGREEMENT SHALL BE LIMITED TO THE AMOUNT ACTUALLY PAID BY YOU FOR SOFTWARE PRODUCT PROVIDED, HOWEVER, IF YOU HAVE ENTERED INTO A MIKROELEKTRONIKA ASSOCIATES SUPPORT SERVICES AGREEMENT, MIKROELEKTRONIKA ASSOCIATES’ ENTIRE LIABILITY REGARDING SUPPORT SERVICES SHALL BE GOVERNED BY THE TERMS OF THAT AGREEMENT.

HIGH RISK ACTIVITIES

Software is not fault-tolerant and is not designed, manufactured or intended for use or resale as on-line control equipment in hazardous environments requiring fail-safe performance, such as in the operation of nuclear facilities, aircraft navigation or communication systems, air traffic control, direct life support machines, or weapons systems, in which the failure of Software could lead directly to death, personal injury, or severe physical or environmental damage (“High Risk Activities”). mikroElektronika Associates and its suppliers specifically disclaim any expressed or implied warranty of fitness for High Risk Activities.

GENERAL PROVISIONS

This statement may only be modified in writing signed by you and an authorised officer of mikroElektronika Associates. If any provision of this statement is found void or unenforceable, the remainder will remain valid and enforceable according to its terms. If any remedy provided is determined to have failed for its essential purpose, all limitations of liability and exclusions of damages set forth in the Limited Warranty shall remain in effect.

This statement gives you specific legal rights; you may have others, which vary, from country to country. mikroElektronika Associates reserves all rights not specifically granted in this statement.

mikroElektronika

Visegradska 1A,
11000 Belgrade,
Europe.

Phone: + 381 11 36 28 830

Fax: +381 11 36 28 831

Web: www.mikroe.com

E-mail: office@mikroe.com

TECHNICAL SUPPORT

In case you encounter any problem, you are welcome to our support forums at www.mikroe.com/forum/. Here, you may also find helpful information, hardware tips, and practical code snippets. Your comments and suggestions on future development of the mikroBasic PRO for AVR are always appreciated — feel free to drop a note or two on our Wishlist.

In our Knowledge Base www.mikroe.com/en/kb/ you can find the answers to Frequently Asked Questions and solutions to known problems. If you can not find the solution to your problem in Knowledge Base then report it to Support Desk www.mikroe.com/en/support/. In this way, we can record and track down bugs more efficiently, which is in our mutual interest. We respond to every bug report and question in a suitable manner, ever improving our technical support.

HOW TO REGISTER

The latest version of the mikroBasic PRO for AVR is always available for downloading from our website. It is a fully functional software libraries, examples, and comprehensive help included.

The only limitation of the free version is that it cannot generate hex output over 2 KB. Although it might sound restrictive, this margin allows you to develop practical, working applications with no thinking of demo limit. If you intend to develop really complex projects in the mikroBasic PRO for AVR, then you should consider the possibility of purchasing the license key.

Who Gets the License Key

Buyers of the mikroBasic PRO for AVR are entitled to the license key. After you have completed the payment procedure, you have an option of registering your mikroBasic PRO. In this way you can generate hex output without any limitations.

How to Get License Key

After you have completed the payment procedure, start the program. Select **Help > How to Register** from the drop-down menu or click the How To Register Icon . Fill out the registration form (figure below), select your distributor, and click the Send button.

h

How To Register

Step 1. Fill in the form below. Please, make sure you fill in all required fields.
Step 2. Make sure that you provided a **valid email address** in the "EMAIL" edit box. This email will be used for sending you the activation key.
Step 3. Make sure you select a correct distributor which will make the registration process faster. If your distributor is not on the list then select "Other" and type in distributor's email address in the box below.
Step 4. Press the **SEND** button to send key request. A default email client will open with ready-to-send message.
 Note: If email client does not open, you may copy text of the message and paste it manually into a new email message before sending it to your distributor's email.

NAME*	Marko Jovanovic
ADDRESS	Enter your address
INVOICE	Enter invoice number if available in the form AAAAA/BB
2CO Number	Enter 2CheckOut Order Number if available (10 digits)
E-MAIL*	marko@mikroe.com
E-MAIL*	marko@mikroe.com
COMPANY	Enter company name
PRODUCT ID	515C-557269-6F6D72-5C5E
COMMENTS:	Enter comments on your order
DISTRIBUTOR*	<div style="border: 1px solid #ccc; padding: 2px;"> mikroElektronika key@mikroe.com </div>

* Required fields

I have made the payment and I wish to request activation key for mikroBasic PRO for AVR

Name:
Marko Jovanovic

Address:

Invoice number:

2CheckOut order number:

Company:

E-Mail:
marko@mikroe.com

Product key:
515C-557269-6F6D72-5C5E

Copy to clipboard

SEND

Cancel

This will start your e-mail client with message ready for sending. Review the information you have entered, and add the comment if you deem it necessary. Please, do not modify the subject line.

Upon receiving and verifying your request, we will send the license key to the e-mail address you specified in the form.

After Receiving the License Key

The license key comes as a small autoextracting file – just start it anywhere on your computer in order to activate your copy of compiler and remove the demo limit. You do not need to restart your computer or install any additional components. Also, there is no need to run the mikroBasic PRO for AVR at the time of activation.

Notes:

- The license key is valid until you format your hard disk. In case you need to format the hard disk, you should request a new activation key.
- Please keep the activation program in a safe place. Every time you upgrade the compiler you should start this program again in order to reactivate the license.

CHAPTER

2

mikroBasic PRO for AVR Environment

The mikroBasic PRO for AVR is an user-friendly and intuitive environment:

IDE OVERVIEW

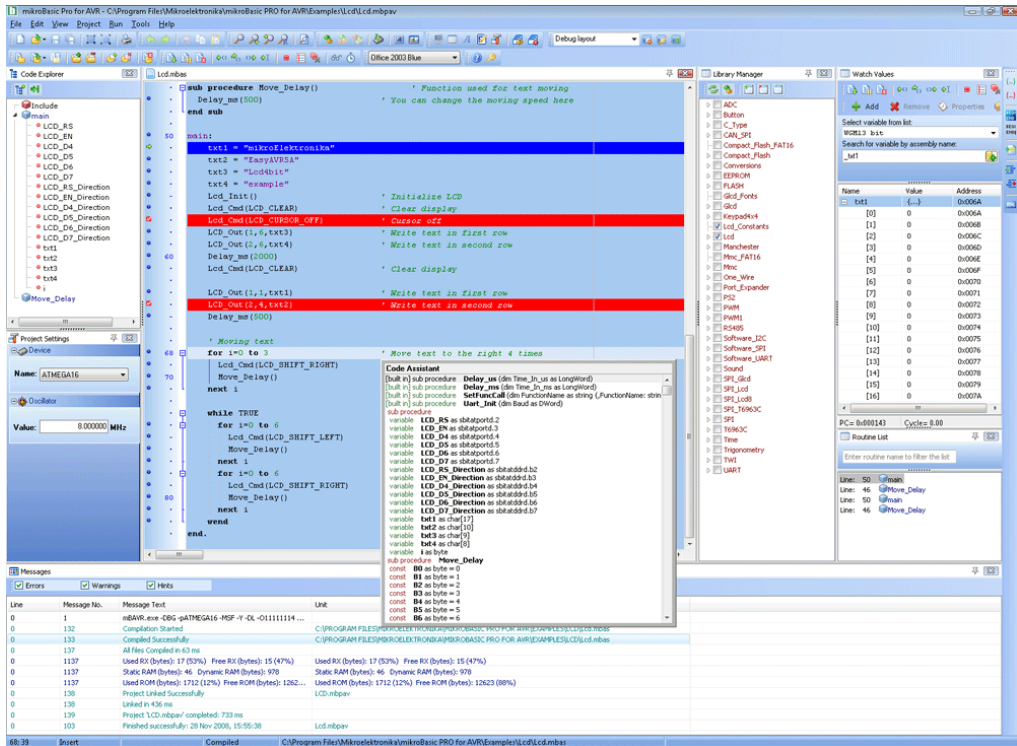

- The Code Editor features adjustable Syntax Highlighting, Code Folding, Code Assistant, Parameters Assistant, Spell Checker, Auto Correct for common typos and Code Templates (Auto Complete).
- The Code Explorer (with Keyboard shortcut browser and Quick Help browser) is at your disposal for easier project management.
- The Project Manager allows multiple project management
- General project settings can be made in the Project Settings window
- Library manager enables simple handling libraries being used in a project
- The Error Window displays all errors detected during compiling and linking.
- The source-level Software Simulator lets you debug executable logic step-by-step by watching the program flow.
- The New Project Wizard is a fast, reliable, and easy way to create a project.
- Help files are syntax and context sensitive.
- Like in any modern Windows application, you may customize the layout of mikroBasic PRO for AVR to suit your needs best.
- Spell checker underlines identifiers which are unknown to the project. In this way it helps the programmer to spot potential problems early, much before the project is compiled.
- Spell checker can be disabled by choosing the option in the Preferences dialog (F12).

MAIN MENU OPTIONS

Available Main Menu options are:

File

Edit

View

Project

Run

Tools





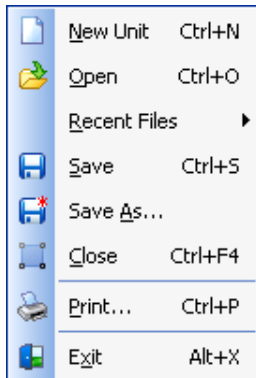

Help

Related topics: Keyboard shortcuts

FILE MENU OPTIONS













The File menu is the main entry point for manipulation with the source files.





















File	Description
 <u>N</u> ew Unit Ctrl+N	Open a new editor window.
 <u>O</u> pen Ctrl+O	Open source file for editing or image file for viewing.
<u>R</u> ecent Files ▶	Reopen recently used file.
 <u>S</u> ave Ctrl+S	Save changes for active editor.
 <u>S</u> ave <u>A</u> s...	Save the active source file with the different name or change the file type.
 <u>C</u> lose Alt+F4	Close active source file.
 <u>P</u> rint... Ctrl+P	Print Preview.
 <u>E</u> xit Alt+X	Exit IDE.

Related topics: Keyboard shortcuts, File Toolbar, Managing Source Files

EDIT MENU OPTIONS

	<u>ndo</u>	Ctrl+Z
	Redo	Shift+Ctrl+Z
	C <u>ut</u>	Ctrl+X
	C <u>opy</u>	Ctrl+C
	P <u>aste</u>	Ctrl+V
	D <u>elete</u>	
	Select <u>A</u> ll	Ctrl+A
	F <u>ind</u> ...	Ctrl+F
	F <u>ind</u> <u>N</u> ext	F3
	F <u>ind</u> P <u>revious</u>	Shift+F3
	R <u>eplace</u> ...	Ctrl+R
	F <u>ind</u> In F <u>iles</u> ...	Alt+F3
	G <u>oto</u> Line...	Ctrl+G
	Adv <u>a</u> nced	▶

File	Description
 <u>ndo</u> Ctrl+Z	Undo last change.
 Redo Shift+Ctrl+Z	Redo last change.
 C <u>ut</u> Ctrl+X	Cut selected text to clipboard.
 C <u>opy</u> Ctrl+C	Copy selected text to clipboard.
 P <u>aste</u> Ctrl+V	Paste text from clipboard.
 D <u>elete</u>	Delete selected text.
Select <u>A</u> ll Ctrl+A	Select all text in active editor.
 F <u>ind</u> ... Ctrl+F	Find text in active editor.
 F <u>ind</u> <u>N</u> ext F3	Find next occurrence of text in active editor.
 F <u>ind</u> P <u>revious</u> Shift+F3	Find previous occurrence of text in active editor.
 R <u>eplace</u> ... Ctrl+R	Replace text in active editor.
 F <u>ind</u> In F <u>iles</u> ... Alt+F3	Find text in current file, in all opened files, or in files from desired folder.
 G <u>oto</u> Line... Ctrl+G	Goto to the desired line in active editor.
Adv <u>a</u> nced ▶	Advanced Code Editor options

File	Description
 <u>C</u> omment Shift+Ctrl+.,	Comment selected code or put single line comment if there is no selection.
 <u>U</u> ncomment Shift+Ctrl+.,	Uncomment selected code or remove single line comment if there is no selection.
 <u>I</u> ndent Shift+Ctrl+I	Indent selected code.
 <u>O</u> utdent Shift+Ctrl+U	Outdent selected code.
 <u>L</u> owercase Ctrl+Alt+L	Changes selected text case to lowercase.
 <u>U</u> ppercase Ctrl+Alt+U	Changes selected text case to uppercase.
 <u>T</u> itlecase Ctrl+Alt+T	Changes selected text case to titlecase.

Find Text

Dialog box for searching the document for the specified text. The search is performed in the direction specified. If the string is not found a message is displayed.

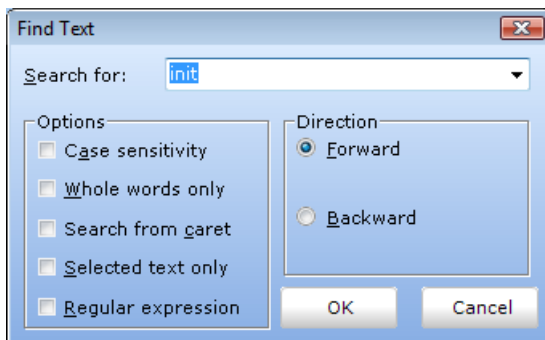

Find In Files

Dialog box for searching for a text string in current file, all opened files, or in files on a disk.

The string to search for is specified in the **Text to find** field. If Search in directories option is selected, The files to search are specified in the **Files mask** and Path fields.

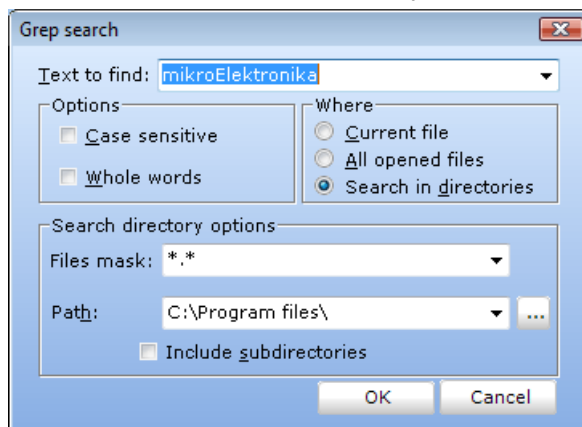

Go To Line

Dialog box that allows the user to specify the line number at which the cursor should be positioned.

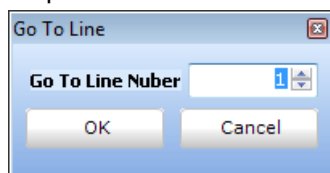

Regular expressions

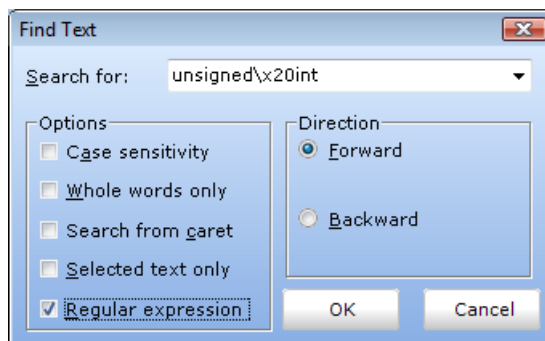

By checking this box, you will be able to advance your search, through Regular expressions.

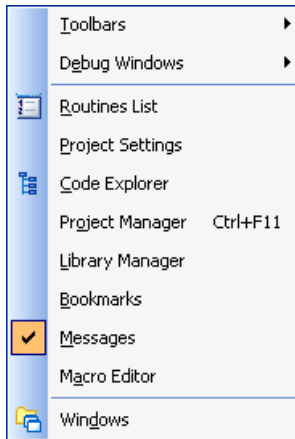

Related topics: Keyboard shortcuts, Edit Toolbar, Advanced Edit Toolbar

VIEW MENU OPTIONS









File	Description
Toolbars	Show/Hide toolbars.
Debug Windows	Show/Hide debug windows.
 Routines List	Show/Hide Routine List in active editor.
Project Settings	Show/Hide Project Settings window.
 Code Explorer	Show/Hide Code Explorer window.
Project Manager Shift+Ctrl+F11	Show/Hide Project Manager window.
Library Manager	Show/Hide Library Manager window.
Bookmarks	Show/Hide Bookmarks window.
Messages	Show/Hide Error Messages window.
Macro Editor	Show/Hide Macro Editor window.
 Windows	Show Window List window.

TOOLBARS

File Toolbar







File Toolbar is a standard toolbar with following options:

Icon	Description
	Opens a new editor window.
	Open source file for editing or image file for viewing.
	Save changes for active window.
	Save changes in all opened windows.
	Close current editor.
	Close all editors.
	Print Preview.

Edit Toolbar











Edit Toolbar is a standard toolbar with following options:

Icon	Description
	Undo last change.
	Redo last change.
	Cut selected text to clipboard.
	Copy selected text to clipboard.
	Paste text from clipboard.

Advanced Edit Toolbar







Advanced Edit Toolbar comes with following options:

Icon	Description
	Comment selected code or put single line comment if there is no selection
	Uncomment selected code or remove single line comment if there is no selection.
	Select text from starting delimiter to ending delimiter.
	Go to ending delimiter.
	Go to line.
	Indent selected code lines.
	Outdent selected code lines.
	Generate HTML code suitable for publishing current source code on the web.

Find/Replace Toolbar











Find/Replace Toolbar is a standard toolbar with following options:

Icon	Description
	Find text in current editor.
	Find next occurrence.
	Find previous occurrence.
	Replace text.
	Find text in files.

Project Toolbar









Project Toolbar comes with following options:

Icon	Description
	Open new project wizard. wizard.
	Open Project
	Save Project
	Add existing project to project group.
	Remove existing project from project group.
	Add File To Project
	Remove File From Project
	Close current project.

Build Toolbar



Build Toolbar comes with following options:

Icon	Description
	Build current project.
	Build all opened projects.
	Build and program active project.
	Start programmer and load current HEX file.
	Open assembly code in editor.
	View statistics for current project.

Debugger



Debugger Toolbar comes with following options:

Icon	Description
	Start Software Simulator.
	Run/Pause debugger.
	Stop debugger.
	Step into.
	Step over.
	Step out.
	Run to cursor.
	Toggle breakpoint.
	Toggle breakpoints.
	Clear breakpoints.
	View watch window
	View stopwatch window

Styles Toolbar

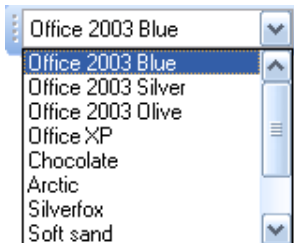





Styles toolbar allows you to easily customize your workspace.

Tools Toolbar



Tools Toolbar comes with following default options:









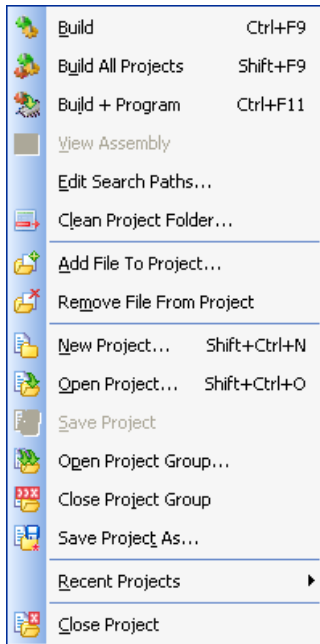





Icon	Description
	Run USART Terminal
	EEPROM
	ASCII Chart
	Seven segment decoder tool.

The Tools toolbar can easily be customized by adding new tools in Options(F12) window.

Related topics: Keyboard shortcuts, Integrated Tools, Debugger Windows













PROJECT MENU OPTIONS















Project	Description
 <u>B</u> uild Ctrl+F9	Build active project.
 <u>B</u> uild All Shift+F9	Build all projects.
 <u>B</u> uild + Program Ctrl+F11	Build and program active project.
 <u>V</u> iew Assembly	View Assembly.
<u>E</u> dit Search Paths...	Edit search paths.
 <u>C</u> lean Project Folder...	Clean Project Folder
 <u>A</u> dd File To Project...	Add file to project.
 <u>R</u> emove File From Project	Remove file from project.
 <u>N</u> ew Project...	Open New Project Wizard
 <u>O</u> pen Project... Shift+Ctrl+O	Open existing project.
 <u>S</u> ave Project	Save current project.
 <u>O</u> pen Project Group...	Open project group.
 <u>C</u> lose Project Group	Close project group.
 <u>S</u> ave Project As...	Save active project file with the different name.
<u>R</u> ecent Projects ▶	Open recently used project.
 <u>C</u> lose Project	Close active project.

Related topics: Keyboard shortcuts, Project Toolbar, Creating New Project, Project Manager, Project Settings

RUN MENU OPTIONS







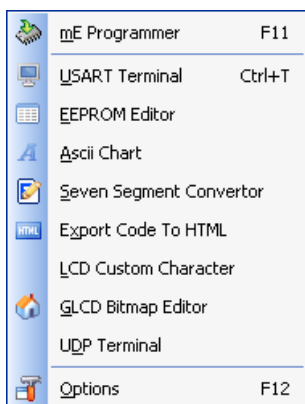

	Start Debugger	F9
	Stop Debugger	Ctrl+F2
	Pause Debugger	F6
	Step Into	F7
	Step Over	F8
	Step Out	Ctrl+F8
	Jump To Interrupt	F2
	Toggle Breakpoint	F5
	Breakpoints	Shift+F4
	Clear Breakpoints	Shift+Ctrl+F5
	Watch Window	Shift+F5
	View Stopwatch	
	Disassembly mode	Alt+D

File	Description
 Start Debugger F9	Start Software Simulator.
 Stop Debugger Ctrl+F2	Stop debugger.
 Pause Debugger F6	Pause Debugger.
 Step Into F7	Step Into.
 Step Over F8	Step Over.
 Step Out Ctrl+F8	Step Out.
 Jump To Interrupt F2	Jump to interrupt in current project.
 Toggle Breakpoint F5	Toggle Breakpoint.
 Show/Hide Breakpoints Shift+F4	Breakpoints.
 Clear Breakpoints Shift+Ctrl+F5	Clear Breakpoints.
 Watch Window Shift+F5	Show/Hide Watch Window
 View Stopwatch	Show/Hide Stopwatch Window
Disassembly mode Ctrl+D	Toggle between Basic source and disassembly.

Related topics: Keyboard shortcuts, Debug Toolbar

TOOLS MENU OPTIONS



Tools	Description
 m E Programmer F11	Run mikroElektronika Programmer
 U SART Terminal Ctrl+T	Run USART Terminal
 E EPR <small>OM</small> Editor	Run EEPROM Editor
 A scii Chart	Run ASCII Chart
 S even Segment Convertor	Run 7 Segment Display Decoder
 E xport Code To HTML	Generate HTML code suitable for publishing source code on the web.
L CD Custom Character	Generate your own custom Lcd characters
 G LCD Bitmap Editor	Generate bitmap pictures for Glcd
U DP Terminal	UDP communication terminal.
 O ptions F12	Open Options window

Related topics: Keyboard shortcuts, Tools Toolbar

HELP MENU OPTIONS

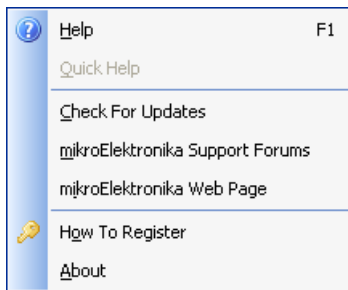

File	Description
<u>H</u> elp F1	Open Help File.
<u>Q</u> uick Help	Quick Help.
<u>C</u> heck For Updates	Check if new compiler version is available.
<u>m</u> ikroElektronika Support Forums	Open mikroElektronika Support Forums in a default browser.
<u>m</u> ikroElektronika Web Page	Open mikroElektronika Web Page in a default browser.
<u>H</u> ow To Register	Information on how to register
<u>A</u> bout	Open About window.

Related topics: Keyboard shortcuts

KEYBOARD SHORTCUTS

Below is a complete list of keyboard shortcuts available in mikroBasic PRO for AVR IDE. You can also view keyboard shortcuts in the Code Explorer window, tab Keyboard.

IDE Shortcuts		Ctrl+X	Cut
F1	Help	Ctrl+Y	Delete entire line
Ctrl+N	New Unit	Ctrl+Z	Undo
Ctrl+O	Open	Ctrl+Shift+Z	Redo
Ctrl+Shift+O	Open Project	Advanced Editor Shortcuts	
Ctrl+Shift+N	Open New Project	Ctrl+Space	Code Assistant
Ctrl+K	Close Project	Ctrl+Shift+Space	Parameters Assistant
Ctrl+F9	Compile	Ctrl+D	Find declaration
Shift+F9	Compile All	Ctrl+E	Incremental Search
Ctrl+F11	Compile and Program	Ctrl+L	Routine List
Shift+F4	View breakpoints	Ctrl+G	Goto line
Ctrl+Shift+F5	Clear breakpoints	Ctrl+J	Insert Code Template
F11	Start AVRFlash Programmer	Ctrl+Shift+.	Comment Code
F12	Preferences	Ctrl+Shift+,	Uncomment Code
Basic Editor Shortcuts		Ctrl+number	Goto bookmark
F3	Find, Find Next	Ctrl+Shift+number	Set bookmark
Shift+F3	Find Previous	Ctrl+Shift+l	Indent selection
Alt+F3	Grep Search, Find in Files	Ctrl+Shift+U	Unindent selection
Ctrl+A	Select All	TAB	Indent selection
Ctrl+C	Copy	Shift+TAB	Unindent selection
Ctrl+F	Find	Alt+Select	Select columns
Ctrl+R	Replace	Ctrl+Alt+Select	Select columns
Ctrl+P	Print	Ctrl+Alt+L	Convert selection to lowercase
Ctrl+S	Save unit	Ctrl+Alt+U	Convert selection to uppercase
Ctrl+Shift+S	Save All	Ctrl+Alt+T	Convert to Titlecase
Ctrl+V	Paste		

Software Simulator Shortcuts	
F2	Jump To Interrupt
F4	Run to Cursor
F5	Toggle Breakpoint
F6	Run/Pause Debugger
F7	Step into
F8	Step over
F9	Debug
Ctrl+F2	Reset
Ctrl+F5	Add to Watch List
Ctrl+F8	Step out
Alt+D	Dissassembly view
Shift+F5	Open Watch Window

IDE OVERVIEW

The mikroBasic PRO for AVR is an user-friendly and intuitive environment:

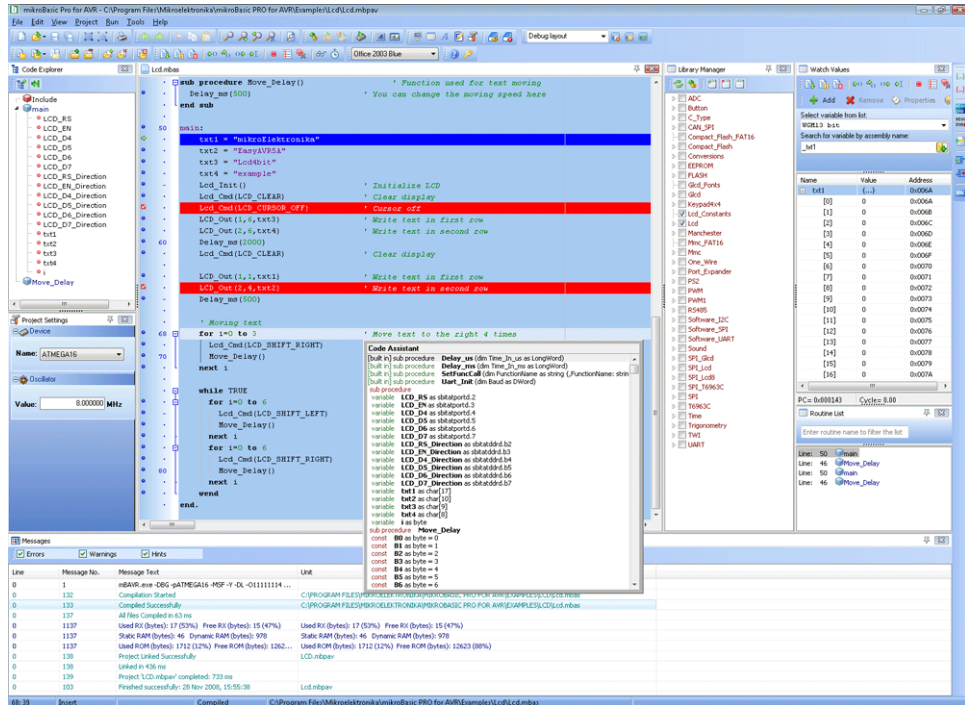

- The Code Editor features adjustable Syntax Highlighting, Code Folding, Code Assistant, Parameters Assistant, Spell Checker, Auto Correct for common typos and Code Templates (Auto Complete).
- The Code Explorer (with Keyboard shortcut browser and Quick Help browser) is at your disposal for easier project management.
- The Project Manager allows multiple project management
- General project settings can be made in the Project Settings window
- Library manager enables simple handling libraries being used in a project
- The Error Window displays all errors detected during compiling and linking.
- The source-level Software Simulator lets you debug executable logic step-by-step by watching the program flow.
- The New Project Wizard is a fast, reliable, and easy way to create a project.
- Help files are syntax and context sensitive.
- Like in any modern Windows application, you may customize the layout of mikroBasic PRO for AVR to suit your needs best.
- Spell checker underlines identifiers which are unknown to the project. In this way it helps the programmer to spot potential problems early, much before the project is compiled.
- Spell checker can be disabled by choosing the option in the Preferences dialog (F12).

CUSTOMIZING IDE LAYOUT

Docking Windows

You can increase the viewing and editing space for code, depending on how you arrange the windows in the IDE.

Step 1: Click the window you want to dock, to give it focus.

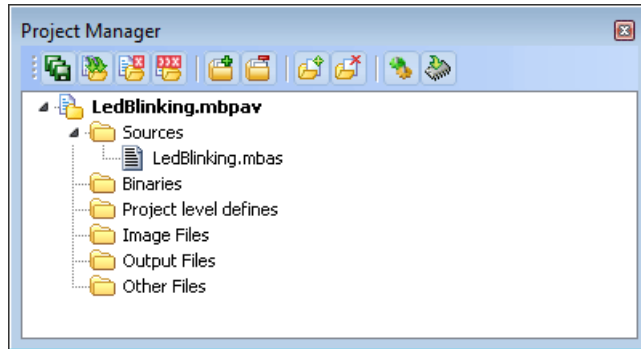

Step 2: Drag the tool window from its current location. A guide diamond appears. The four arrows of the diamond point towards the four edges of the IDE.

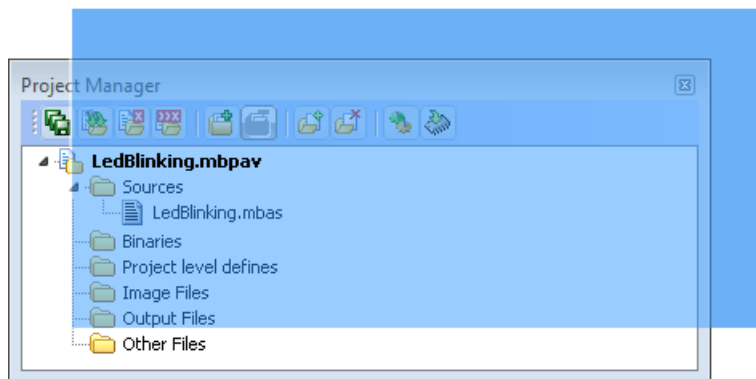

Step 3: Move the pointer over the corresponding portion of the guide diamond. An outline of the window appears in the designated area.

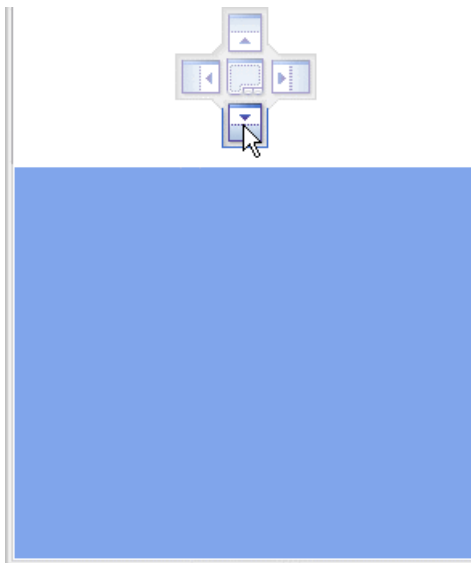



Step 4: To dock the window in the position indicated, release the mouse button.

Tip: To move a dockable window without snapping it into place, press CTRL while dragging it.

Saving Layout

Once you have a window layout that you like, you can save the layout by typing the name for the layout and pressing the Save Layout Icon .

To set the layout select the desired layout from the layout drop-down list and click the Set Layout Icon .

To remove the layout from the drop-down list, select the desired layout from the list and click the Delete Layout Icon .

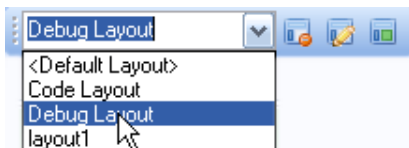

Auto Hide

Auto Hide enables you to see more of your code at one time by minimizing tool windows along the edges of the IDE when not in use.

- Click the window you want to keep visible to give it focus.
- Click the Pushpin Icon  on the title bar of the window.

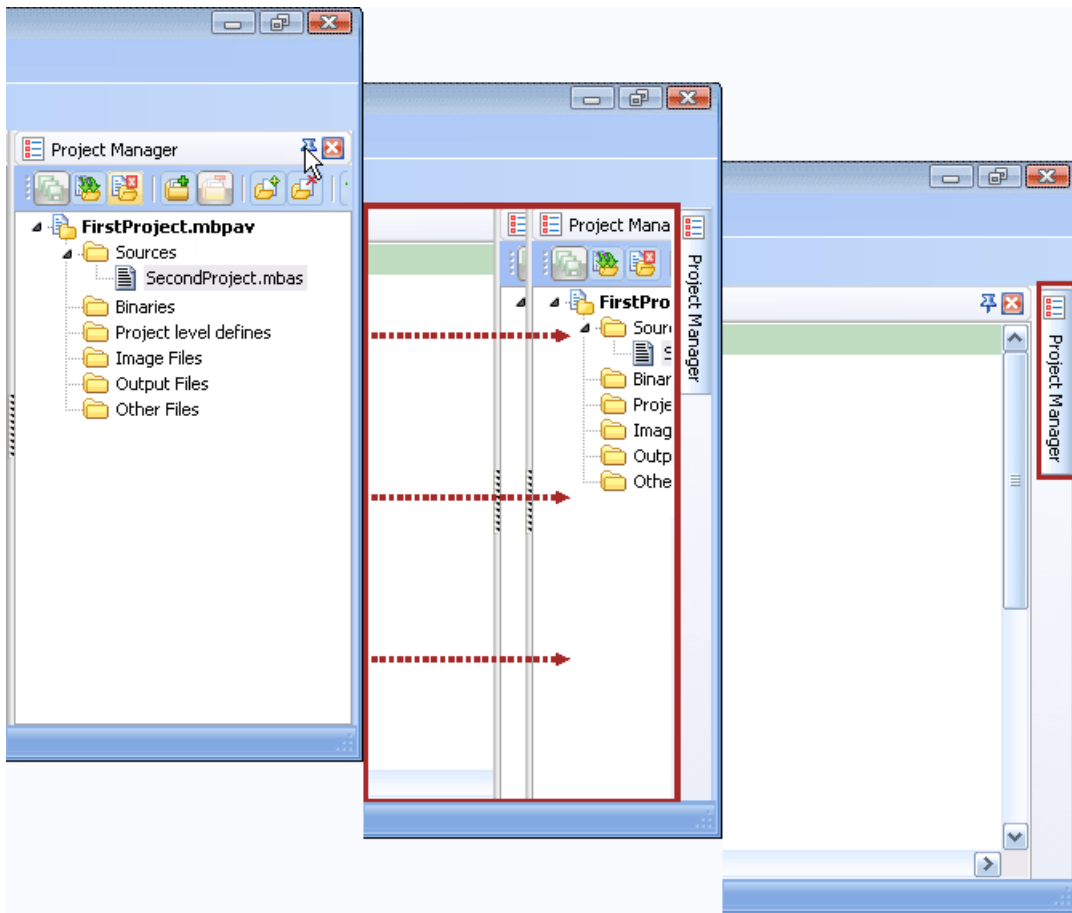

When an auto-hidden window loses focus, it automatically slides back to its tab on the edge of the IDE. While a window is auto-hidden, its name and icon are visible on a tab at the edge of the IDE. To display an auto-hidden window, move your pointer over the tab. The window slides back into view and is ready for use.

ADVANCED CODE EDITOR

The Code Editor is advanced text editor fashioned to satisfy needs of professionals. General code editing is the same as working with any standard text-editor, including familiar Copy, Paste and Undo actions, common for Windows environment.

Advanced Editor Features

- Adjustable Syntax Highlighting
- Code Assistant
- Code Folding
- Parameter Assistant
- Code Templates (Auto Complete)
- Auto Correct for common typos
- Spell Checker
- Bookmarks and Goto Line
- Comment / Uncomment

You can configure the Syntax Highlighting, Code Templates and Auto Correct from the Editor Settings dialog. To access the Settings, click **Tools** > **Options** from the drop-down menu, click the Show Options Icon  or press F12 key.

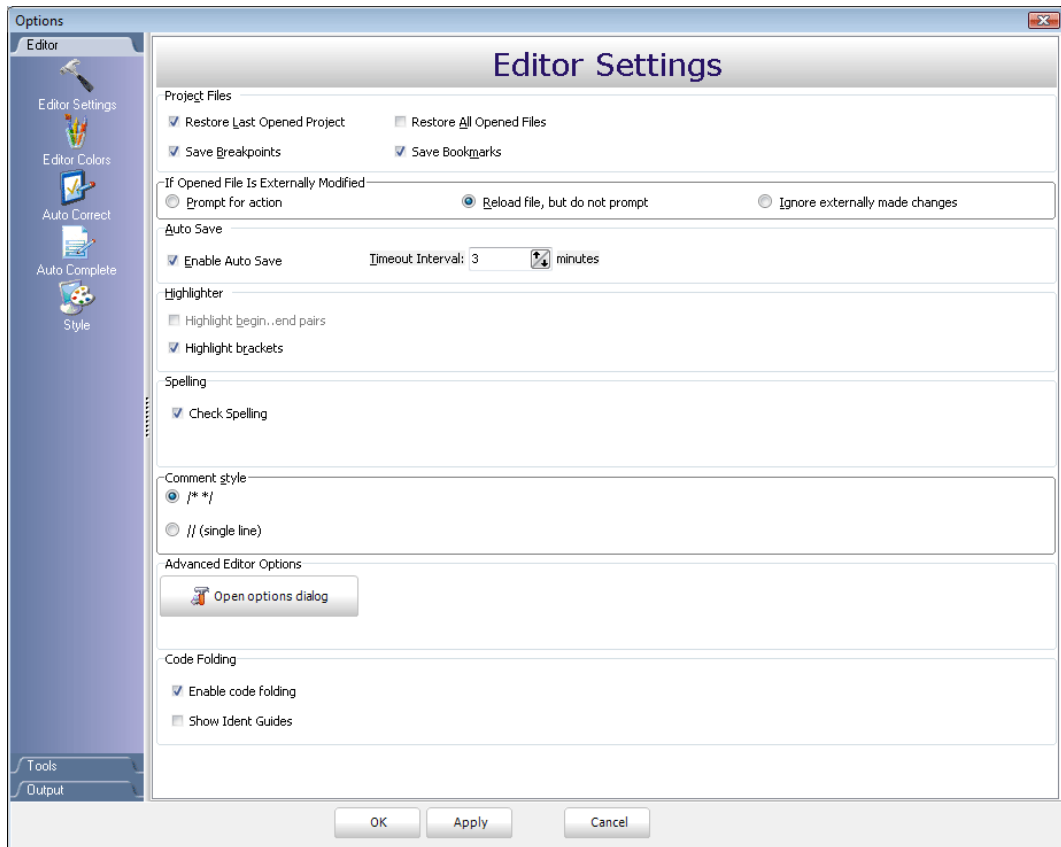



Code Assistant

If you type the first few letters of a word and then press Ctrl+Space, all valid identifiers matching the letters you have typed will be prompted in a floating panel (see the image below). Now you can keep typing to narrow the choice, or you can select one from the list using the keyboard arrows and Enter.



Code Folding

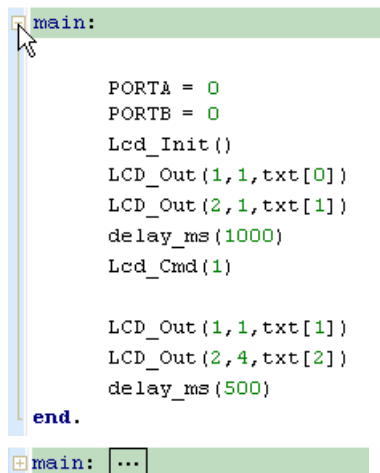

Code folding is IDE feature which allows users to selectively hide and display sections of a source file. In this way it is easier to manage large regions of code within one window, while still viewing only those subsections of the code that are relevant during a particular editing session.

While typing, the code folding symbols ( and ) appear automatically. Use the folding symbols to hide/unhide the code subsections.



```
main:
    PORTA = 0
    PORTB = 0
    Lcd_Init()
    LCD_Out(1,1,txt[0])
    LCD_Out(2,1,txt[1])
    delay_ms(1000)
    Lcd_Cmd(1)

    LCD_Out(1,1,txt[1])
    LCD_Out(2,4,txt[2])
    delay_ms(500)
end.
```

 main: 

If you place a mouse cursor over the tooltip box, the collapsed text will be shown in a tooltip style box.

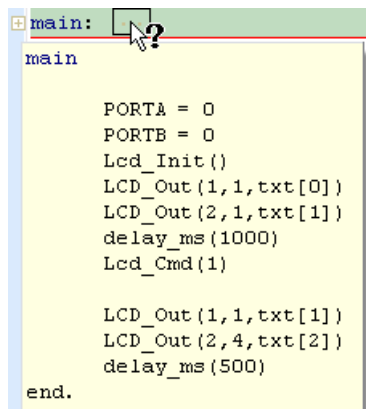

```
main
    PORTA = 0
    PORTB = 0
    Lcd_Init()
    LCD_Out(1,1,txt[0])
    LCD_Out(2,1,txt[1])
    delay_ms(1000)
    Lcd_Cmd(1)

    LCD_Out(1,1,txt[1])
    LCD_Out(2,4,txt[2])
    delay_ms(500)
end.
```

Parameter Assistant

The Parameter Assistant will be automatically invoked when you open parenthesis “(” or press Shift+Ctrl+Space. If the name of a valid function precedes the parenthesis, then the expected parameters will be displayed in a floating panel. As you type the actual parameter, the next expected parameter will become bold.

```
ADC_Read(channel : byte)
```

Code Templates (Auto Complete)

You can insert the Code Template by typing the name of the template (for instance, `whiles`), then press Ctrl+J and the Code Editor will automatically generate a code.

You can add your own templates to the list. Select **Tools > Options** from the drop-down menu, or click the Show Options Icon  and then select the Auto Complete Tab. Here you can enter the appropriate keyword, description and code of your template.

Autocomplete macros can retrieve system and project information:

- `%DATE%` - current system date
- `%TIME%` - current system time
- `%DEVICE%` - device(MCU) name as specified in project settings
- `%DEVICE_CLOCK%` - clock as specified in project settings
- `%COMPILER%` - current compiler version

These macros can be used in template code, see template `ptemplate` provided with mikroBasic PRO for AVR installation.

Auto Correct

The Auto Correct feature corrects common typing mistakes. To access the list of recognized typos, select **Tools > Options** from the drop-down menu, or click the Show Options Icon  and then select the Auto Correct Tab. You can also add your own preferences to the list.

Also, the Code Editor has a feature to comment or uncomment the selected code by simple click of a mouse, using the Comment Icon  and Uncomment Icon  from the Code Toolbar.

Spell Checker

The Spell Checker underlines unknown objects in the code, so it can be easily noticed and corrected before compiling your project.

Select **Tools > Options** from the drop-down menu, or click the Show Options Icon



and then select the Spell Checker Tab.



Bookmarks

Bookmarks make navigation through a large code easier. To set a bookmark, use Ctrl+Shift+number. To jump to a bookmark, use Ctrl+number.

Goto Line

The Goto Line option makes navigation through a large code easier. Use the short-cut Ctrl+G to activate this option.

Comment / Uncomment



Also, the Code Editor has a feature to comment or uncomment the selected code by simple click of a mouse, using the Comment Icon  and Uncomment Icon  from the Code Toolbar.

CODE EXPLORER

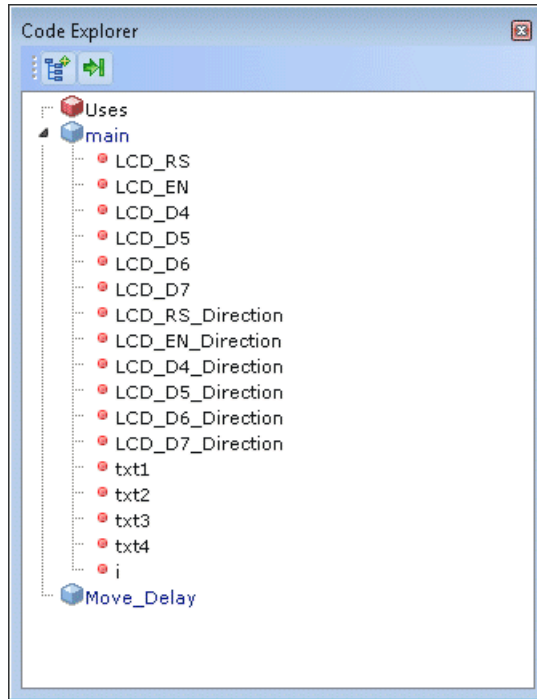
The Code Explorer gives clear view of each item declared inside the source code. You can jump to a declaration of any item by right clicking it. Also, besides the list of defined and declared objects, code explorer displays message about first error and it's location in code.



Following options are available in the Code Explorer:

Icon	Description
	Expand/Collapse all nodes in tree.
	Locate declaration in code.

ROUTINE LIST

Routine list displays list of routines, and enables filtering routines by name. Routine list window can be accessed by pressing Ctrl+L.

You can jump to a desired routine by double clicking on it.

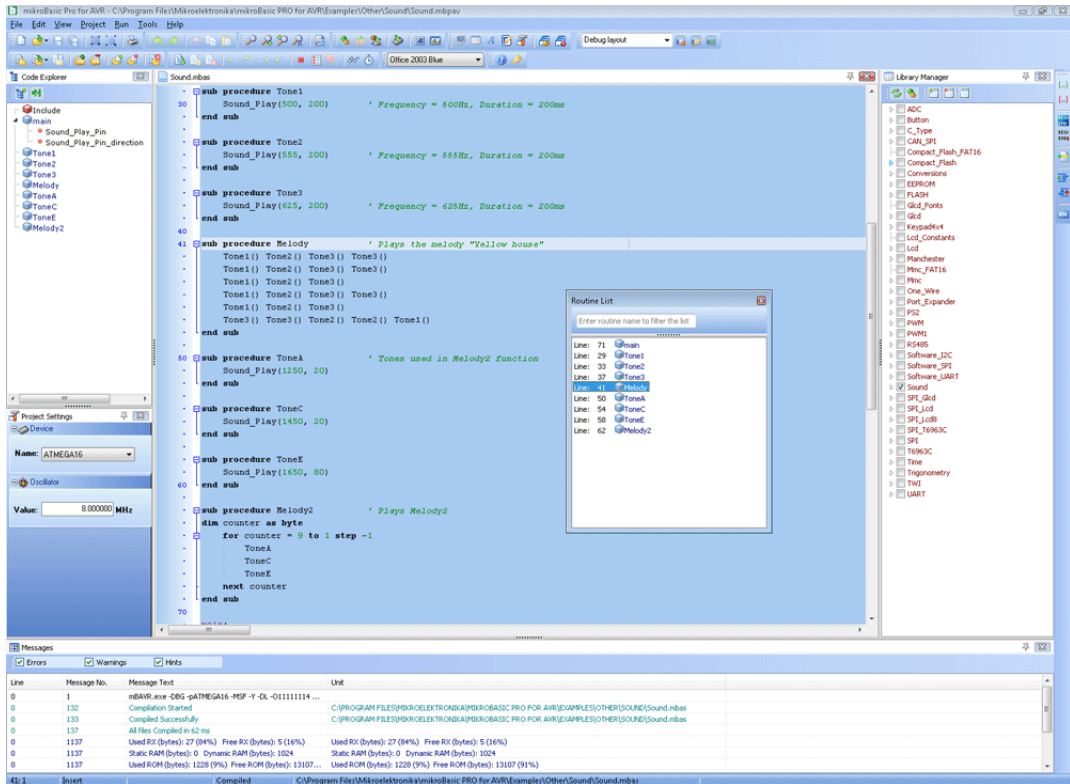

PROJECT MANAGER

Project Manager is IDE feature which allows users to manage multiple projects. Several projects which together make project group may be open at the same time. Only one of them may be active at the moment.

Setting project in **active** mode is performed by **double click** on the desired project in the Project Manager.

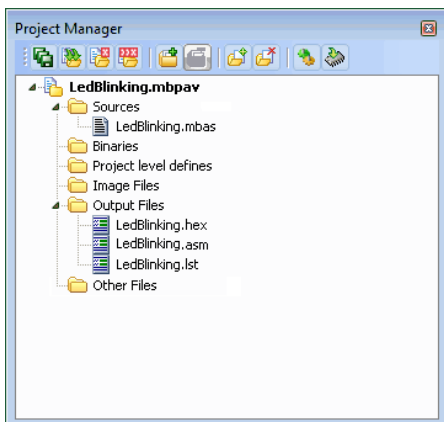

Following options are available in the Project Manager:

Icon	Description
	Save project Group.
	Open project group.
	Close the active project.
	Close project group.
	Add project to the project group.
	Remove project from the project group.
	Add file to the active project.
	Remove selected file from the project.
	Build the active project.
	Run mikroElektronika's Flash programmer.

For details about adding and removing files from project see Add/Remove Files from Project.

Related topics: Project Settings, Project Menu Options, File Menu Options, Project Toolbar, Build Toolbar, Add/Remove Files from Project

PROJECT SETTINGS WINDOW

Following options are available in the Project Settings Window:

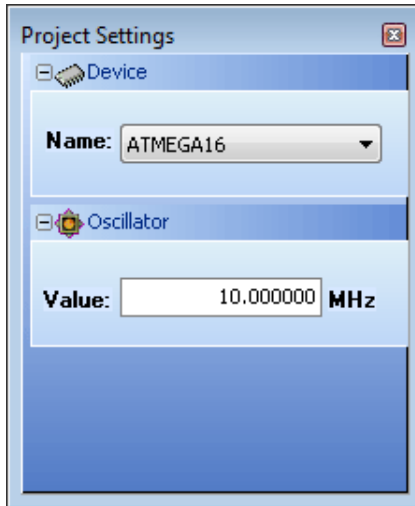

- Device - select the appropriate device from the device drop-down list.
- Oscillator - enter the oscillator frequency value.



Related topics: Project Manager





LIBRARY MANAGER

Library Manager enables simple handling libraries being used in a project. Library Manager window lists all libraries (extension `.mcl`) which are instantly stored in the compiler Uses folder. The desirable library is added to the project by selecting check box next to the library name.

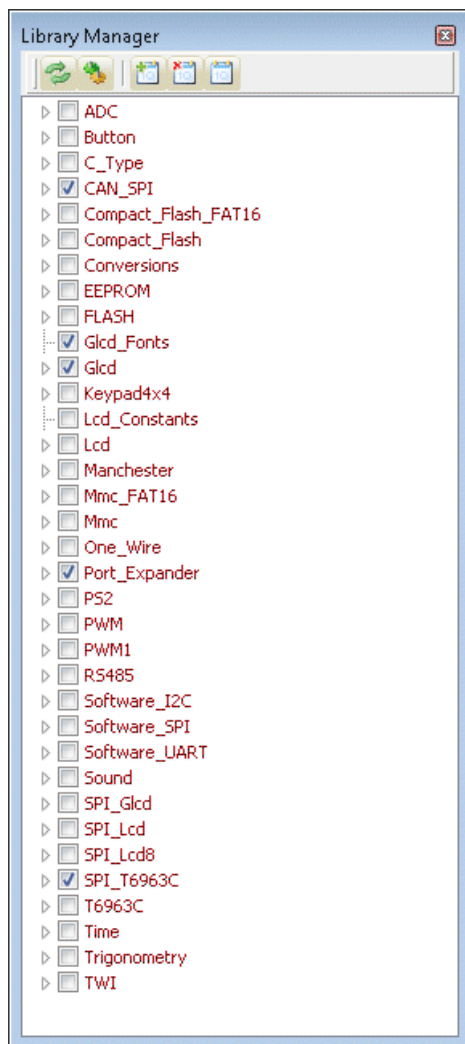
In order to have all library functions accessible, simply press the button **Check All**  and all libraries will be selected. In case none library is needed in a project, press the button **Clear All**  and all libraries will be cleared from the project.

Only the selected libraries will be linked.



Icon	Description
	Refresh Library by scanning files in "Uses" folder. Useful when new libraries are added by copying files to "Uses" folder.
	Rebuild all available libraries. Useful when library sources are available and need refreshing.
	Include all available libraries in current project.
	No libraries from the list will be included in current project.
	Restore library to the state just before last project saving.

Related topics: mikroBasic PRO for AVR Libraries, Creating New Library

ERROR WINDOW

In case that errors were encountered during compiling, the compiler will report them and won't generate a hex file. The Error Window will be prompted at the bottom of the main window by default.

The Error Window is located under message tab, and displays location and type of errors the compiler has encountered. The compiler also reports warnings, but these do not affect the output; only errors can interfere with the generation of hex.

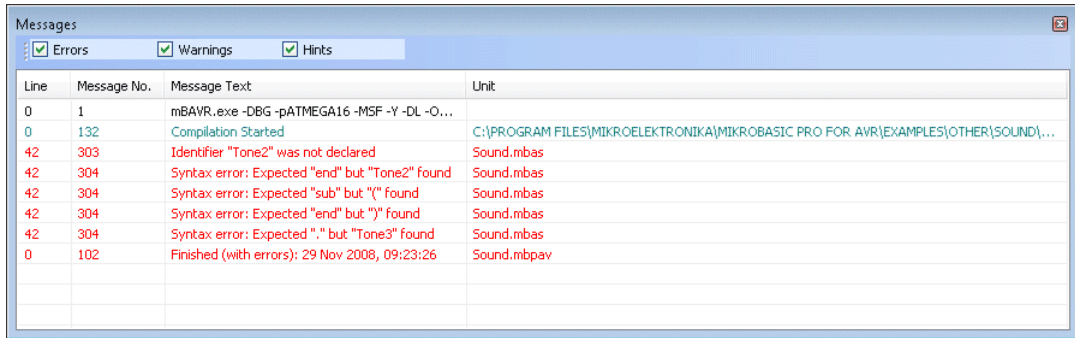

Double click the message line in the Error Window to highlight the line where the error was encountered.

Related topics: Error Messages

STATISTICS

After successful compilation, you can review statistics of your code. Click the Statistics Icon  .

Memory Usage Windows

Provides overview of RAM and ROM usage in the form of histogram.

RAM Memory

Rx Memory Space

Displays Rx memory space usage in form of histogram.

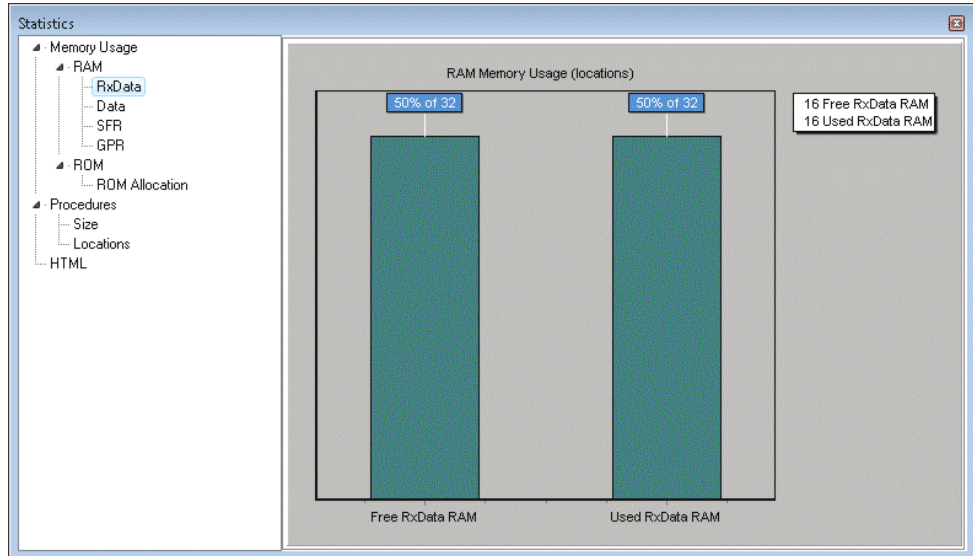

Data Memory Space

Displays Data memory space usage in form of histogram.

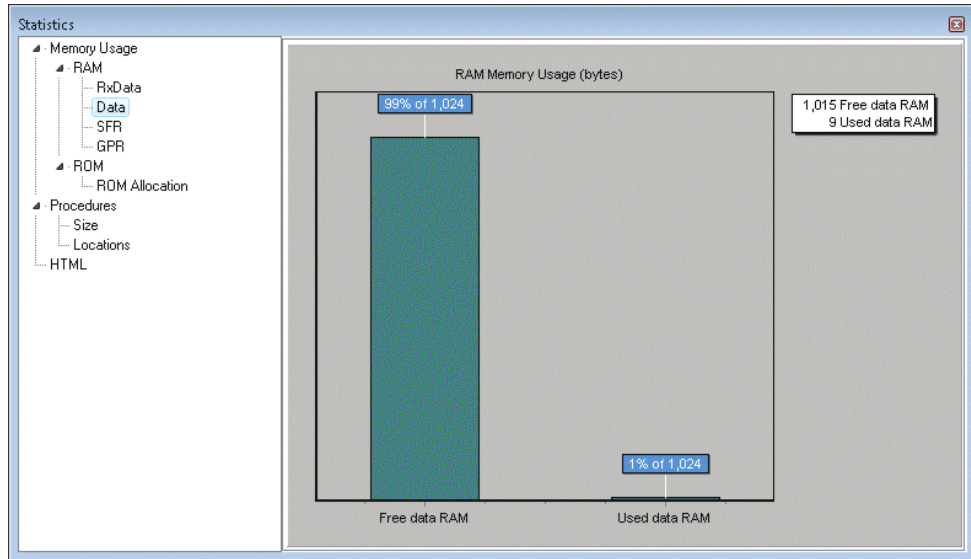

Special Function Registers

Summarizes all Special Function Registers and their addresses.

Statistics

- Memory Usage
 - RAM
 - RxDData
 - Data
 - SFR
 - GPR
 - ROM
 - ROM Allocation
- Procedures
 - Size
 - Locations
- HTML

Special function registers (SFR)

Address	Register
0x00	R0
0x01	R1
0x02	R2
0x03	R3
0x04	R4
0x05	R5
0x06	R6
0x07	R7
0x08	R8
0x09	R9
0x0A	R10
0x0B	R11
0x0C	R12
0x0D	R13
0x0E	R14
0x0F	R15
0x10	R16
0x11	R17

General Purpose Registers

Summarizes all General Purpose Registers and their addresses. Also displays symbolic names of variables and their addresses.

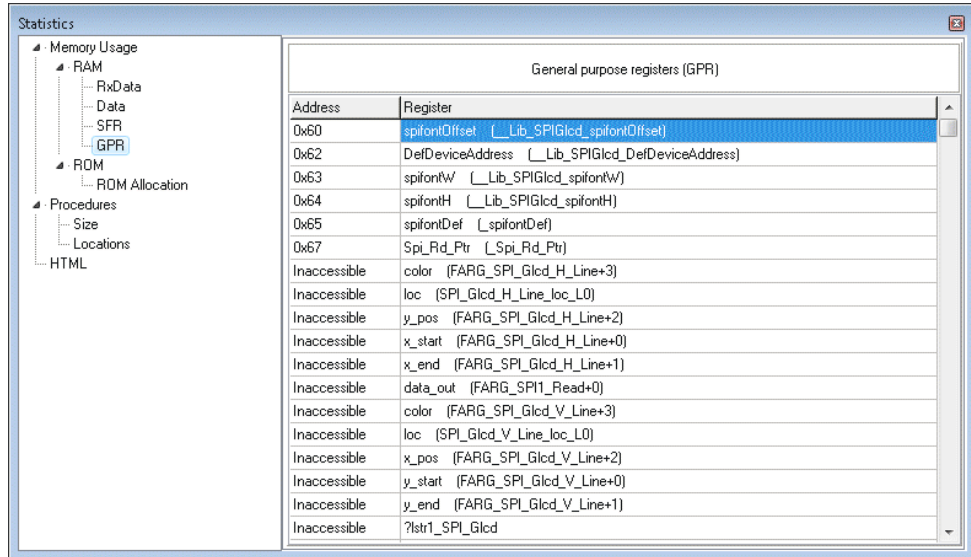

ROM Memory

ROM Memory Usage

Displays ROM memory usage in form of histogram.

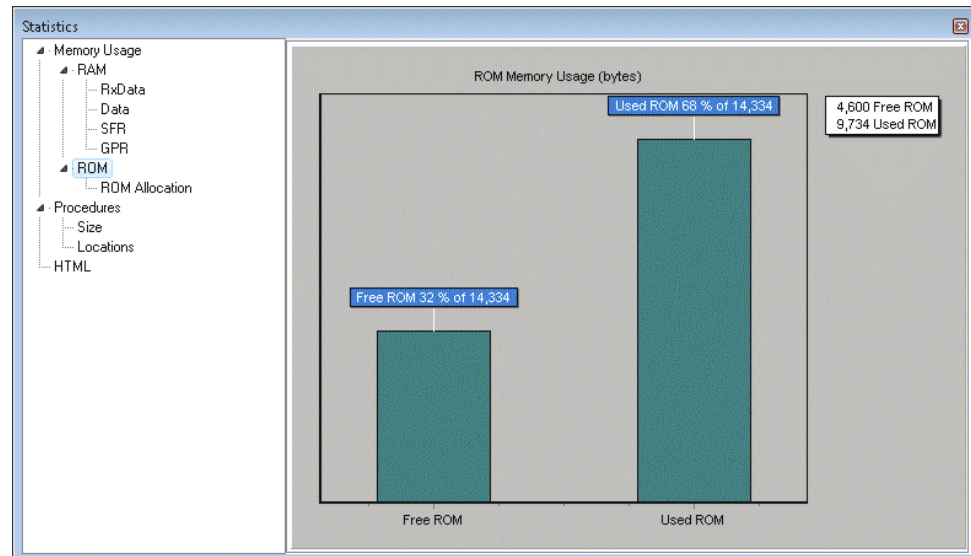

ROM Memory Allocation

Displays ROM memory allocation.

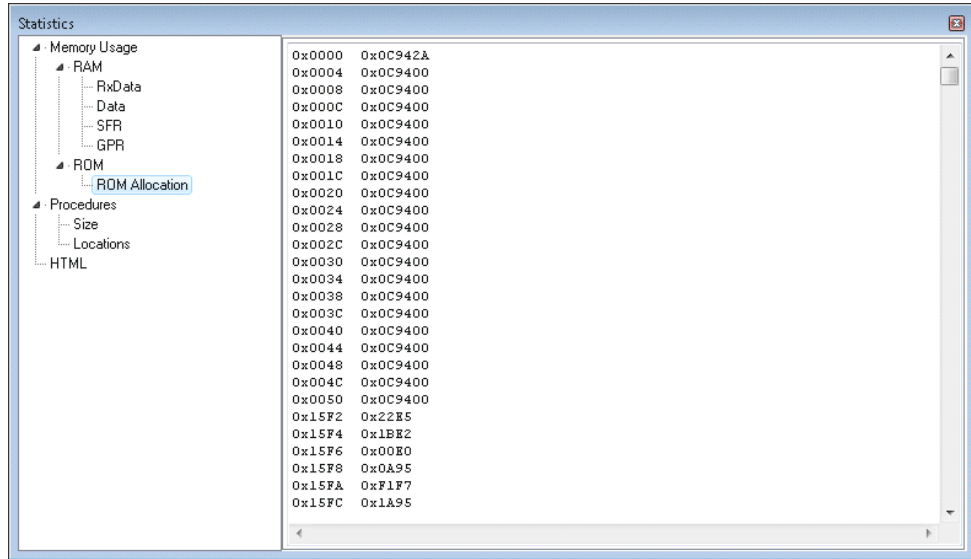

Procedures Windows

Provides overview procedures locations and sizes.

Procedures Size Window

Displays size of each procedure.

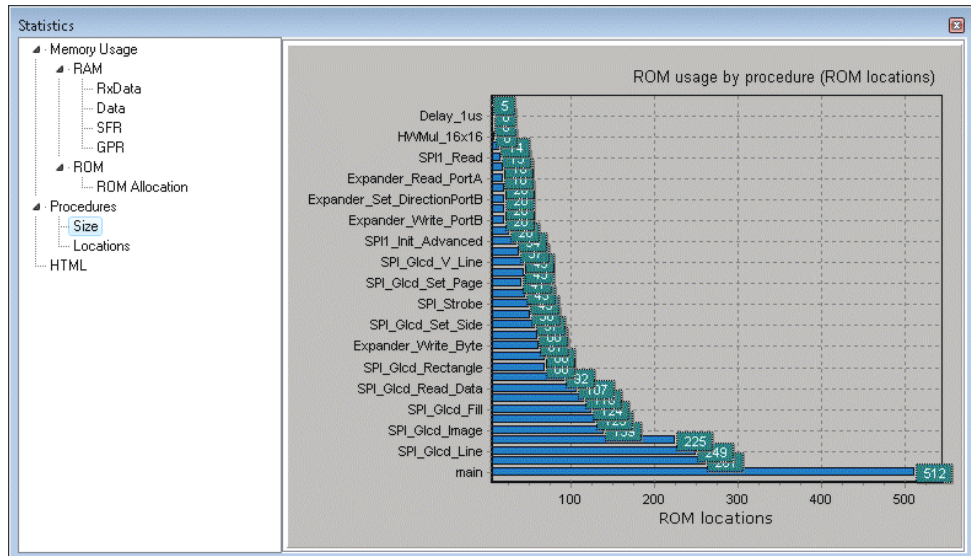

Procedures Locations Window

Displays how functions are distributed in microcontroller's memory.

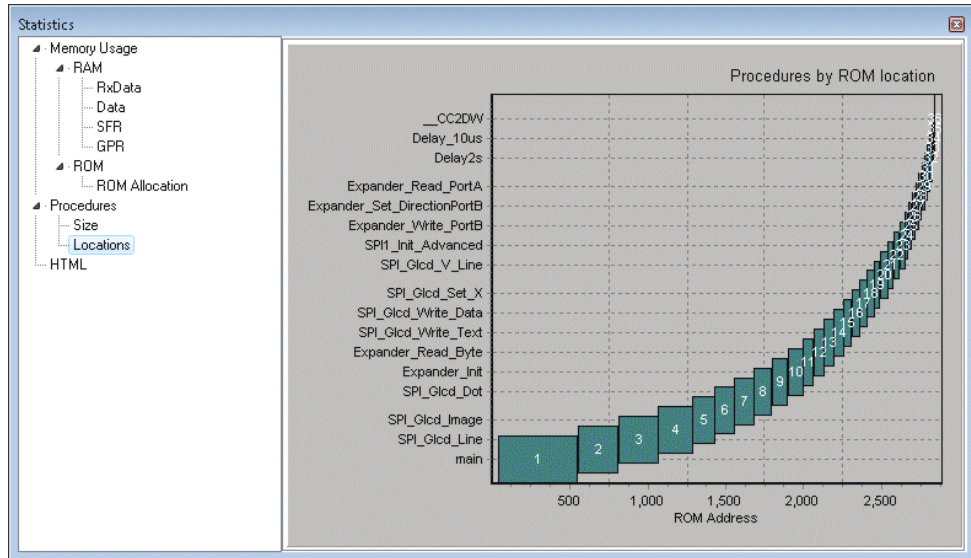

HTML Window

Display statistics in default web browser.

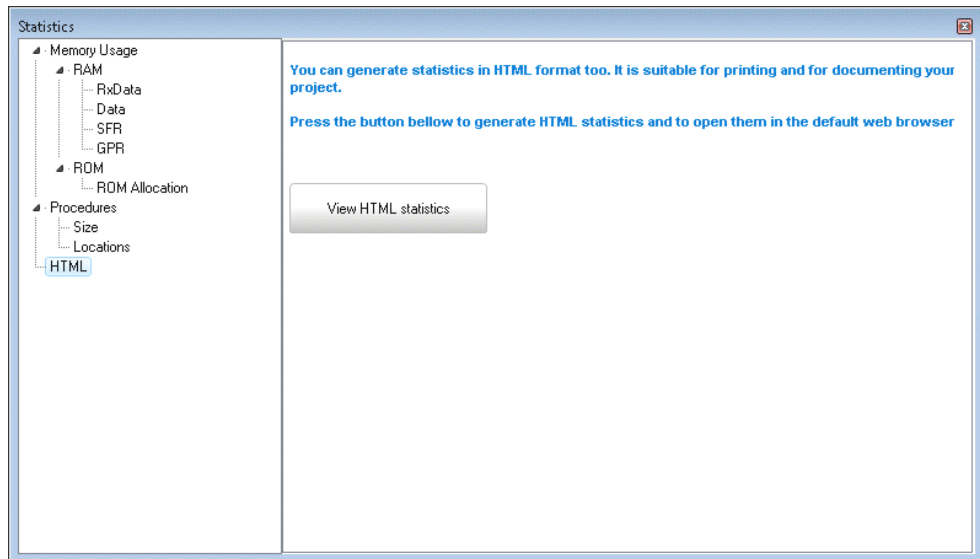

INTEGRATED TOOLS

USART Terminal

The mikroBasic PRO for AVR includes the USART communication terminal for RS232 communication. You can launch it from the drop-down menu **Tools** > **USART Terminal** or by clicking the USART Terminal Icon  from Tools toolbar.

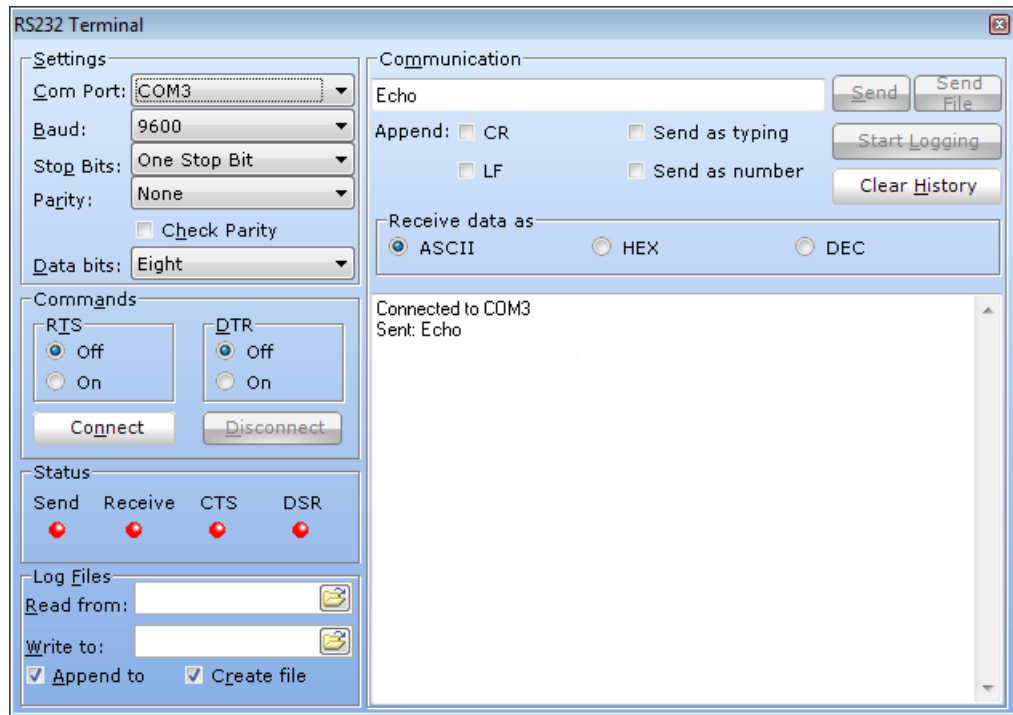

ASCII Chart

The ASCII Chart is a handy tool, particularly useful when working with Lcd display. You can launch it from the drop-down menu **Tools** > **ASCII** chart or by clicking the View ASCII Chart Icon  from Tools toolbar.

	0	1	2	3	4	5	6	7	8	9	A	B	C	D	E	F
0	NUL	SOH	STX	ETX	EOT	ENQ	ACK	BEL	BS	HT	LF	VT	FF	CR	SO	SI
0	1	2	3	4	5	6	7	8	9	10	11	12	13	14	15	
1	DLE	DC1	DC2	DC3	DC4	NAK	SYN	ETB	CAN	EM	SUB	ESC	FS	GS	RS	US
16	17	18	19	20	21	22	23	24	25	26	27	28	29	30	31	
2	SPC	!	"	#	\$	%	'	()	*	+	,	-	.	/	
32	33	34	35	36	37	38	39	40	41	42	43	44	45	46	47	
3	0	1	2	3	4	5	6	7	8	9	:	;	<	=	>	?
48	49	50	51	52	53	54	55	56	57	58	59	60	61	62	63	
4	@	A	B	C	D	E	F	G	H	I	J	K	L	M	N	O
64	65	66	67	68	69	70	71	72	73	74	75	76	77	78	79	
5	P	Q	R	S	T	U	V	W	X	Y	Z	[\]	^	_
80	81	82	83	84	85	86	87	88	89	90	91	92	93	94	95	
6	`	a	b	c	d	e	f	g	h	i	j	k	l	m	n	o
96	97	98	99	100	101	102	103	104	105	106	107	108	109	110	111	
7	p	q	r	s	t	u	v	w	x	y	z	{		}	~	DEL
112	113	114	115	116	117	118	119	120	121	122	123	124	125	126	127	
8	€	,	f	„	…	†	‡	ˆ	˜	™	š	›	œ	ž	ÿ	
128	129	130	131	132	133	134	135	136	137	138	139	140	141	142	143	
9	‘	’	“	”	•	—	—	~	™	š	›	œ	ž	ÿ		
144	145	146	147	148	149	150	151	152	153	154	155	156	157	158	159	
A	ı	¢	£	¤	¥	¦	§	¨	©	ª	«	¬	®	¯		
160	161	162	163	164	165	166	167	168	169	170	171	172	173	174	175	
B	°	±	²	³	´	µ	¶	·	¸	¹	º	»	¼	½	¾	¿
176	177	178	179	180	181	182	183	184	185	186	187	188	189	190	191	
C	À	Á	Â	Ã	Ä	Å	Æ	Ç	È	É	Ê	Ë	Ì	Í	Î	Ï
192	193	194	195	196	197	198	199	200	201	202	203	204	205	206	207	
D	Ð	Ñ	Ò	Ó	Ô	Õ	Ö	×	Ø	Ù	Ú	Û	Ü	Ý	Þ	ß
208	209	210	211	212	213	214	215	216	217	218	219	220	221	222	223	
E	à	á	â	ã	ä	å	æ	ç	è	é	ê	ë	ì	í	î	ï
224	225	226	227	228	229	230	231	232	233	234	235	236	237	238	239	
F	ð	ñ	ò	ó	ô	õ	ö	÷	ø	ù	ú	û	ü	ý	þ	ÿ
240	241	242	243	244	245	246	247	248	249	250	251	252	253	254	255	

EEPROM Editor

The EEPROM Editor is used for manipulating MCU's EEPROM memory. You can launch it from the drop-down menu **Tools > EEPROM Editor**. When Use this EEPROM definition is checked compiler will generate Intel hex file `project_name.ihex` that contains data from EEPROM editor.

When you run mikroElektronika programmer software from mikroBasic PRO for AVR IDE - `project_name.hex` file will be loaded automatically while ihex file must be loaded manually.

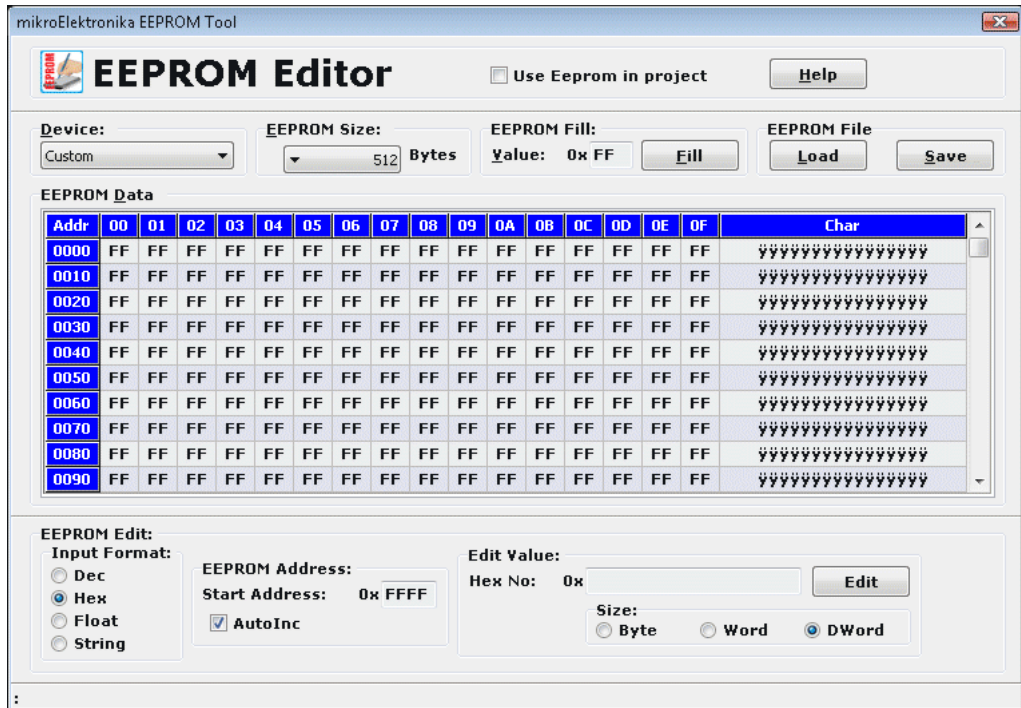

7 Segment Display Decoder

The 7 Segment Display Decoder is a convenient visual panel which returns decimal/hex value for any viable combination you would like to display on 7seg. Click on the parts of 7 segment image to get the requested value in the edit boxes. You can launch it from the drop-down menu **Tools > 7 Segment Decoder** or by clicking the Seven Segment Icon  from Tools toolbar.

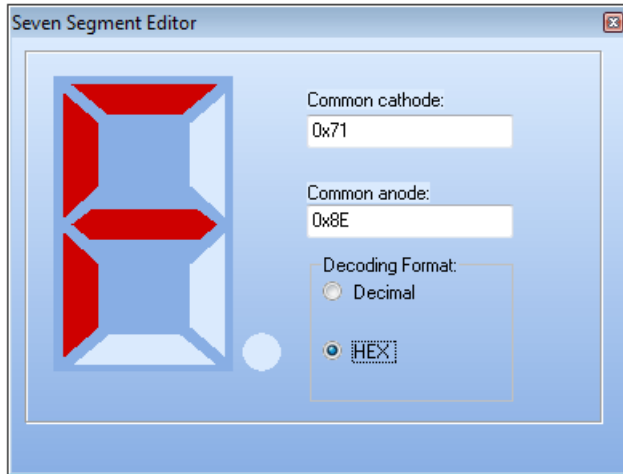

UDP Terminal

The mikroBasic PRO for AVR includes the UDP Terminal. You can launch it from the drop-down menu **Tools > UDP Terminal**.

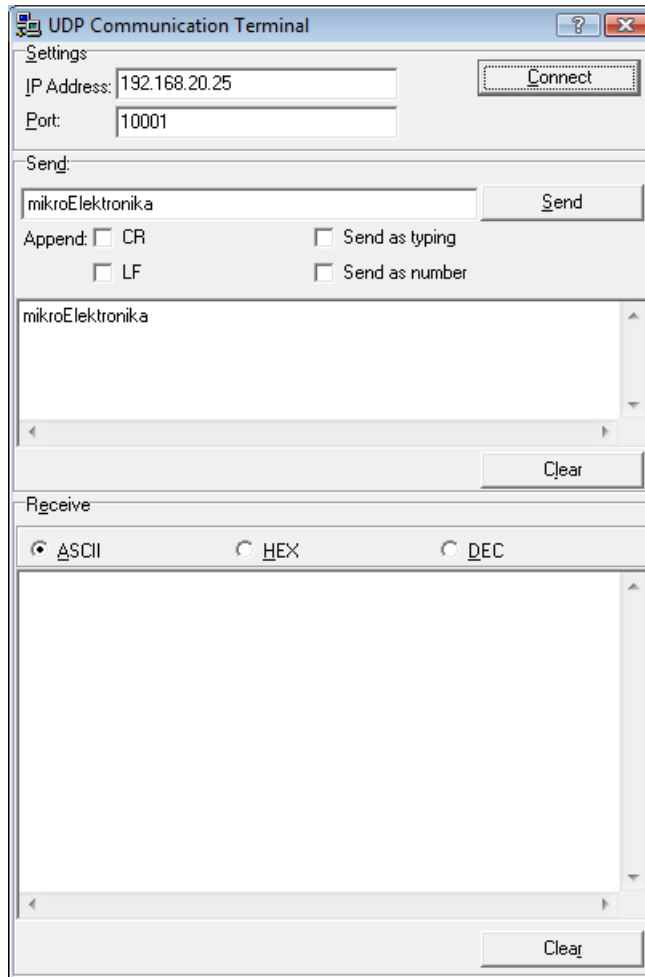

Lcd Custom Character

mikroBasic PRO for AVR includes the Lcd Custom Character. Output is mikroBasic PRO for AVR compatible code. You can launch it from the drop-down menu **Tools** > **Lcd Custom Character**.

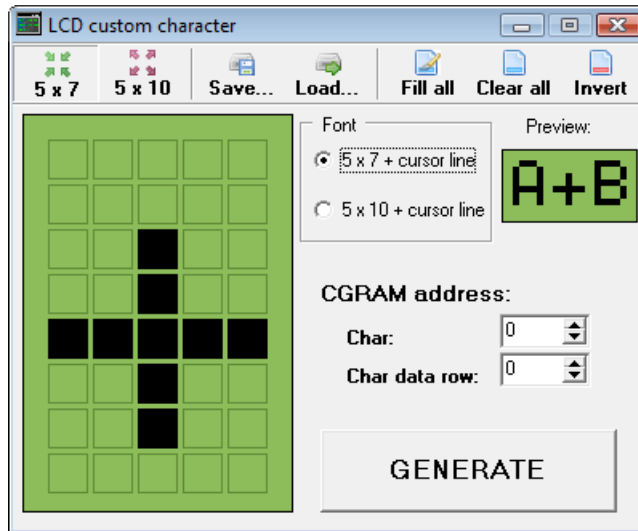

MACRO EDITOR

A macro is a series of keystrokes that have been 'recorded' in the order performed. A macro allows you to 'record' a series of keystrokes and then 'playback', or repeat, the recorded keystrokes.

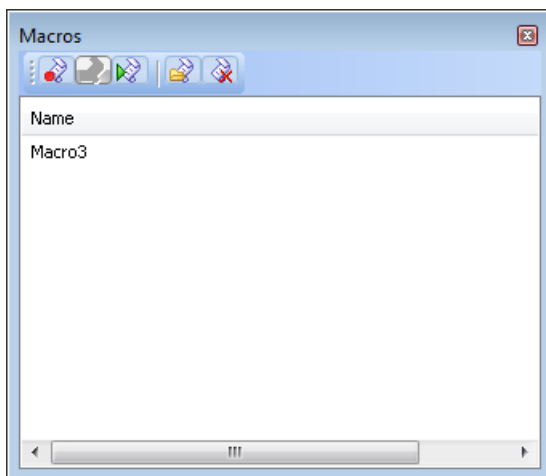

The Macro offers the following commands:

Icon	Description
	Starts 'recording' keystrokes for later playback.
	Stops capturing keystrokes that was started when the Start Recording command was selected.
	Allows a macro that has been recorded to be replayed.
	New macro.
	Delete macro.

Related topics: [Advanced Code Editor](#), [Code Templates](#)

OPTIONS

Options menu consists of three tabs: Code Editor, Tools and Output settings

Code editor

The Code Editor is advanced text editor fashioned to satisfy needs of professionals.

Tools

The mikroBasic PRO for AVR includes the Tools tab, which enables the use of shortcuts to external programs, like Calculator or Notepad.

You can set up to 10 different shortcuts, by editing Tool0 - Tool9.

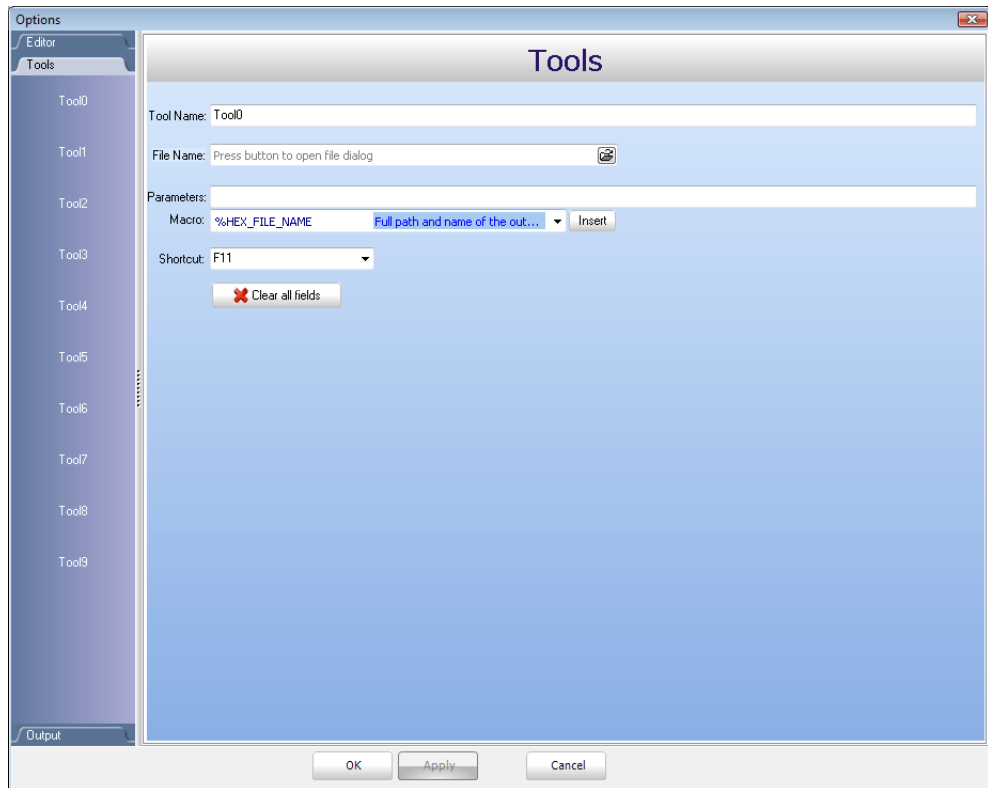

Output settings

By modifying Output Settings, user can configure the content of the output files. You can enable or disable, for example, generation of ASM and List file.

Also, user can choose optimization level, and compiler specific settings, which include case sensitivity, dynamic link for string literals setting (described in mikroBasic PRO for AVR specifics).

Build all files as library enables user to use compiled library (*.mcl) on any AVR MCU (when this box is checked), or for a selected AVR MCU (when this box is left unchecked).

For more information on creating new libraries, see Creating New Library.

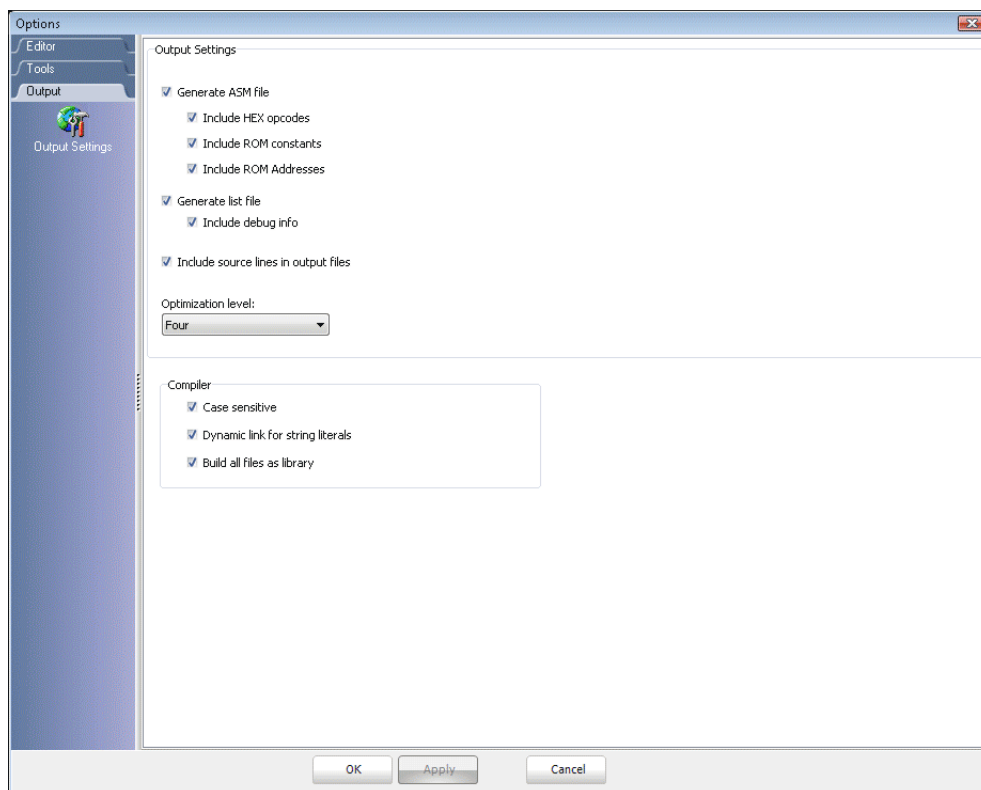

REGULAR EXPRESSIONS

Introduction

Regular Expressions are a widely-used method of specifying patterns of text to search for. Special metacharacters allow you to specify, for instance, that a particular string you are looking for, occurs at the beginning, or end of a line, or contains n recurrences of a certain character.

Simple matches

Any single character matches itself, unless it is a metacharacter with a special meaning described below. A series of characters matches that series of characters in the target string, so the pattern "short" would match "short" in the target string. You can cause characters that normally function as metacharacters or escape sequences to be interpreted by preceding them with a backslash "\ ". For instance, metacharacter "^" matches beginning of string, but "\\^" matches character "^", and "\\\" matches "\", etc.

Examples :

```
unsigned matches string 'unsigned'  
\^unsigned matches string '^unsigned'
```

Escape sequences

Characters may be specified using a escape sequences: "\n" matches a newline, "\t" a tab, etc. More generally, \xnn, where nn is a string of hexadecimal digits, matches the character whose ASCII value is nn.

If you need wide (Unicode) character code, you can use '\x{ nnnn} ', where 'nnnn' - one or more hexadecimal digits.

- \xnn - char with hex code nn
- \x{ nnnn} - char with hex code nnnn (one byte for plain text and two bytes for Unicode)
- \t - tab (HT/TAB), same as \x09
- \n - newline (NL), same as \x0a
- \r - car.return (CR), same as \x0d
- \f - form feed (FF), same as \x0c
- \a - alarm (bell) (BEL), same as \x07
- \e - escape (ESC) , same as \x1b

Examples:

```
unsigned\x20int matches 'unsigned int' (note space in the middle)  
\tunsigned matches 'unsigned' (predecessed by tab)
```

Character classes

You can specify a character class, by enclosing a list of characters in [], which will match any of the characters from the list. If the first character after the "[" is "^", the class matches any character not in the list.

Examples:

```
count[aeiou]r finds strings 'countar', 'counter', etc. but not  
'countbr', 'countcr', etc.  
count[^aeiou]r finds strings 'countbr', 'countcr', etc. but not  
'countar', 'counter', etc.
```

Within a list, the "-" character is used to specify a range, so that a-z represents all characters between "a" and "z", inclusive.

If you want "-" itself to be a member of a class, put it at the start or end of the list, or precede it with a backslash.

If you want "]" , you may place it at the start of list or precede it with a backslash.

Examples:

```
[ -az] matches 'a', 'z' and '-'  
[ az-] matches 'a', 'z' and '-'  
[ a\ -z] matches 'a', 'z' and '-'  
[ a-z] matches all twenty six small characters from 'a' to 'z'  
[ \n-\x0D] matches any of #10,#11,#12,#13.  
[ \d-t] matches any digit, '-' or 't'.  
[ ]-a] matches any char from ']'..'a'.
```

Metacharacters

Metacharacters are special characters which are the essence of regular expressions. There are different types of metacharacters, described below.

Metacharacters - Line separators

```
^ - start of line  
$ - end of line  
\A - start of text  
\Z - end of text  
. - any character in line
```

Examples:

```
^PORTA - matches string ' PORTA ' only if it's at the beginning of line
PORTA$ - matches string ' PORTA ' only if it's at the end of line
^PORTA$ - matches string ' PORTA ' only if it's the only string in line
PORT.r - matches strings like 'PORTA', 'PORTB', 'PORT1' and so on
```

The "^" metacharacter by default is only guaranteed to match beginning of the input string/text, and the "\$" metacharacter only at the end. Embedded line separators will not be matched by "^" or "\$".

You may, however, wish to treat a string as a multi-line buffer, such that the "^" will match after any line separator within the string, and "\$" will match before any line separator.

Regular expressions works with line separators as recommended at <http://www.unicode.org/unicode/reports/tr18/>

Metacharacters - Predefined classes

```
\w - an alphanumeric character (including "_")
\W - a nonalphanumeric character
\d - a numeric character
\D - a non-numeric character
\s - any space (same as [ \t\n\r\f] )
\S - a non space
```

You may use \w, \d and \s within custom character classes.

Example:

```
routi\de - matches strings like 'routile', 'routi6e' and so on, but not
'routine', 'routime' and so on.
```

Metacharacters - Word boundaries

A word boundary ("\\b") is a spot between two characters that has an alphanumeric character ("\\w") on one side, and a nonalphanumeric character ("\\W") on the other side (in either order), counting the imaginary characters off the beginning and end of the string as matching a "\\w".

```
\\b - match a word boundary
\\B - match a non-(word boundary)
```

Metacharacters - Iterators

Any item of a regular expression may be followed by another type of metacharacters - iterators. Using this metacharacters, you can specify number of occurrences of previous character, metacharacter or subexpression.

- * - zero or more ("greedy"), similar to {0,}
- + - one or more ("greedy"), similar to {1,}
- ? - zero or one ("greedy"), similar to {0,1}
- { n } - exactly n times ("greedy")
- { n, } - at least n times ("greedy")
- { n, m } - at least n but not more than m times ("greedy")
- *? - zero or more ("non-greedy"), similar to {0,}?
- +? - one or more ("non-greedy"), similar to {1,}?
- ?? - zero or one ("non-greedy"), similar to {0,1}?
- { n }? - exactly n times ("non-greedy")
- { n, }? - at least n times ("non-greedy")
- { n, m }? - at least n but not more than m times ("non-greedy")

So, digits in curly brackets of the form, { n, m }, specify the minimum number of times to match the item n and the maximum m. The form { n } is equivalent to { n, n } and matches exactly n times. The form { n, } matches n or more times. There is no limit to the size of n or m, but large numbers will chew up more memory and slow down execution.

If a curly bracket occurs in any other context, it is treated as a regular character.

Examples:

```
count.*r - matches strings like 'counter', 'countelkjdfklkj9r' and 'countr'
count.+r - matches strings like 'counter', 'countelkjdfklkj9r' but not 'countr'
count.?r - matches strings like 'counter', 'countar' and 'countr' but not
'countelkj9r'
counte{ 2 } r - matches string 'counteer'
counte{ 2, } r - matches strings like 'counteer', 'counteeer', 'counteeer' etc.
counte{ 2, 3 } r - matches strings like 'counteer', or 'counteeer' but not 'counteeer'
```

A little explanation about "greediness". "Greedy" takes as many as possible, "non-greedy" takes as few as possible.

For example, 'b+' and 'b*' applied to string 'abbbbc' return 'bbbb', 'b+?' returns 'b', 'b*?' returns empty string, 'b{ 2, 3 }?' returns 'bb', 'b{ 2, 3 }' returns 'bbb'.

Metacharacters - Alternatives

You can specify a series of alternatives for a pattern using "|" to separate them, so that bit|bat|bot will match any of "bit", "bat", or "bot" in the target string as would "b(i|a|o)t". The first alternative includes everything from the last pattern delimiter ("(", "[", or the beginning of the pattern) up to the first "|", and the last alternative contains everything from the last "|" to the next pattern delimiter. For this reason, it's common practice to include alternatives in parentheses, to minimize confusion about where they start and end.

Alternatives are tried from left to right, so the first alternative found for which the entire expression matches, is the one that is chosen. This means that alternatives are not necessarily greedy. For example: when matching rou|rout against "routine", only the "rou" part will match, as that is the first alternative tried, and it successfully matches the target string (this might not seem important, but it is important when you are capturing matched text using parentheses.) Also remember that "|" is interpreted as a literal within square brackets, so if you write `[bit|bat|bot]`, you're really only matching `[biao]`.

Examples:

```
rou(tine|te) - matches strings 'routine' or 'route'.
```

Metacharacters - Subexpressions

The bracketing construct (...) may also be used for define regular subexpressions. Subexpressions are numbered based on the left to right order of their opening parenthesis. First subexpression has number '1'

Examples:

```
(int){8,10} matches strings which contain 8, 9 or 10 instances of the 'int'  
routi([0-9]|a+e matches 'routi0e', 'routile', 'routine',  
'routinne', 'routinne' etc.
```

Metacharacters - Backreferences

Metacharacters \1 through \9 are interpreted as backreferences. \ matches previously matched subexpression #.

Examples:

```
(.)\1+ matches 'aaaa' and 'cc'.  
(+)\1+ matches 'abab' and '123123'  
(["' ]?) (\d+)\1 matches "13" (in double quotes), or '4' (in single quotes)  
or 77 (without quotes) etc
```

MIKROBASIC PRO FOR AVR COMMAND LINE OPTIONS

Usage: mBAvr.exe [-<opts> [-<opts>]] [<infile> [-<opts>]] [-<opts>]]
Infile can be of *.mbas and *.mcl type.

The following parameters and some more (see manual) are valid:

- P : MCU for which compilation will be done.
- FO : Set oscillator [in MHz].
- SP : Add directory to the search path list.
- IP : Add directory to the #include search list.
- N : Output files generated to file path specified by filename.
- B : Save compiled binary files (*.mcl) to 'directory'.
- O : Miscellaneous output options.
- DBG : Generate debug info.
- L : Check and rebuild new libraries.
- DL : Build all files as libraries.
- Y : Dynamic link for string literals.
- C : Turn on case sensitivity.

Example:

```
mBAvr.exe -MSF -DBG -pATMEGA16 -C -O11111114 -fo8 -
N"C:\Lcd\Lcd.mcpav" -SP"C:\Program Files\Mikroelektronika\mikroBasic
PRO for AVR\Defs\"
-SP"C:\Program Files\Mikroelektronika\mikroBasic PRO
for AVR\Uses\LTE64KW\" -SP"C:\Lcd\" "Lcd.mbas" "__Lib_Math.mcl"
 "__Lib_MathDouble.mcl"
"__Lib_System.mcl" "__Lib_Delays.mcl"
 "__Lib_LcdConsts.mcl" "__Lib_Lcd.mcl"
```

Parameters used in the example:

- MSF : Short Message Format; used for internal purposes by IDE.
- DBG : Generate debug info.
- pATMEGA16 : MCU ATMEGA16 selected.
- C : Turn on case sensitivity.
- O11111114 : Miscellaneous output options.
- fo8 : Set oscillator frequency [in MHz].
- N"C:\Lcd\Lcd.mcpav" -SP"C:\Program Files\Mikroelektronika\mikroBasic PRO for AVR\defs\" : Output files generated to file path specified by filename.
- SP"C:\Program Files\Mikroelektronika\mikroBasic PRO for AVR\defs\" : Add directory to the search path list.
- SP"C:\Program Files\Mikroelektronika\mikroBasic PRO for AVR\uses\" : Add directory to the search path list.
- SP"C:\Lcd\" : Add directory to the search path list.
- "Lcd.mbas" "__Lib_Math.mcl" "__Lib_MathDouble.mcl" "__Lib_System.mcl" "__Lib_Delays.mcl" "__Lib_LcdConsts.mcl" "__Lib_Lcd.mcl" : Specify input files.

PROJECTS

The mikroBasic PRO for AVR organizes applications into projects, consisting of a single project file (extension `.mcpav`) and one or more source files (extension `.c`). mikroBasic PRO for AVR IDE allows you to manage multiple projects (see Project Manager). Source files can be compiled only if they are part of a project.

The project file contains the following information:

- project name and optional description,
- target device,
- device flags (config word),
- device clock,
- list of the project source files with paths,
- image files,
- other files.

Note that the project does not include files in the same way as preprocessor does, see Add/Remove Files from Project.

NEW PROJECT

The easiest way to create a project is by means of the New Project Wizard, drop-down menu **Project** › **New Project** or by clicking the New Project Icon  from Project Toolbar.

New Project Wizard Steps

Start creating your New project, by clicking Next button:

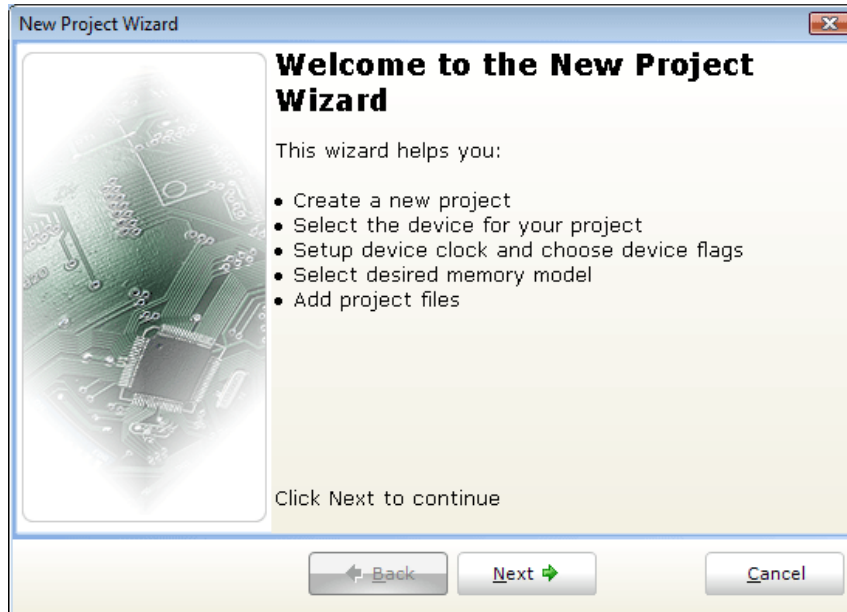

Step One - Select the device from the device drop-down list.

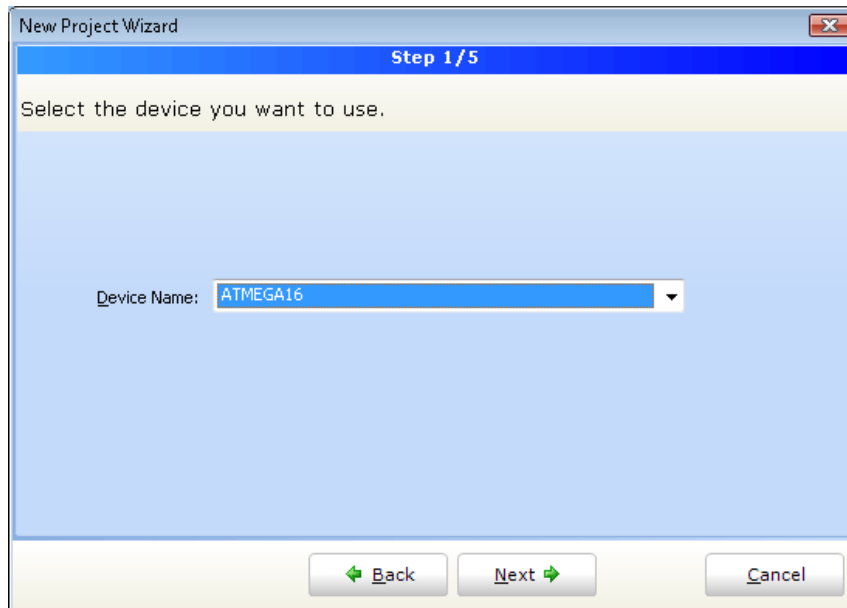

Step Two - Enter the oscillator frequency value.

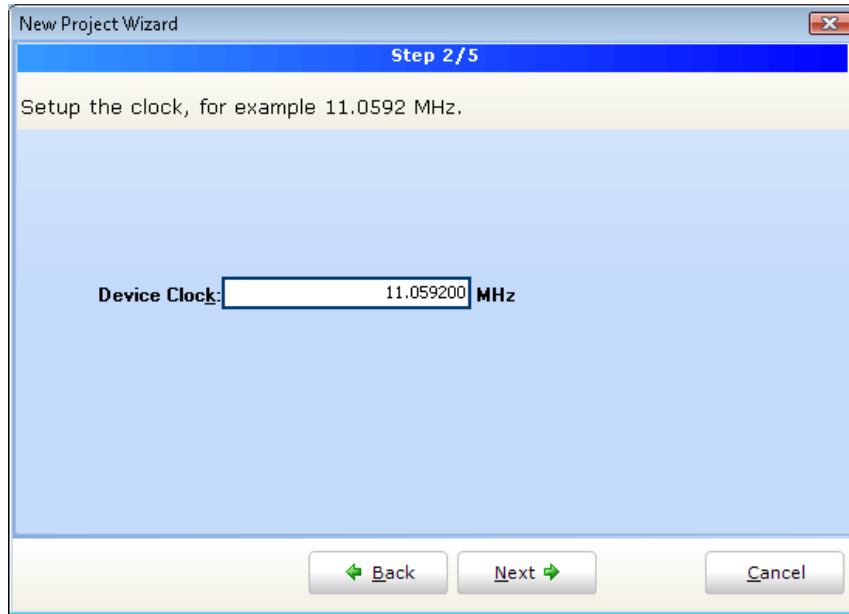

Step Three - Specify the location where your project will be saved.

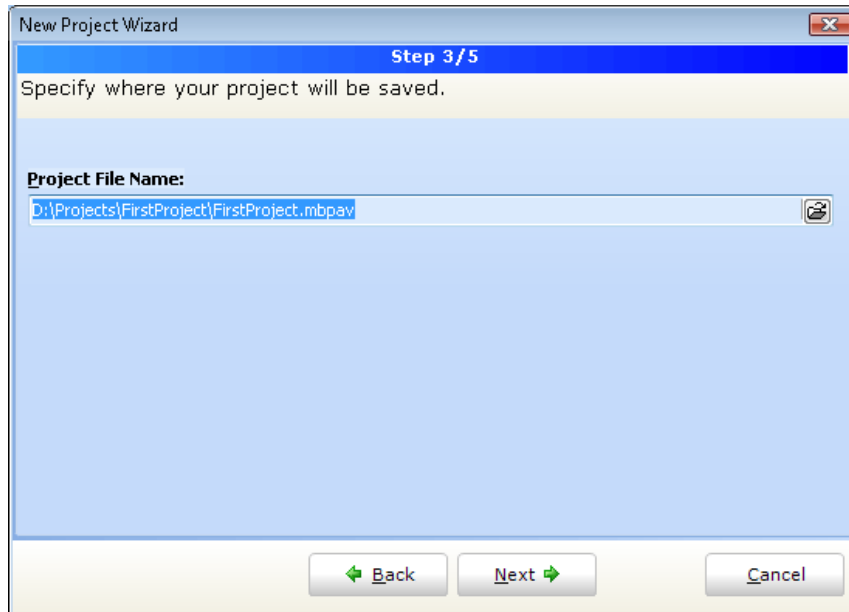

Step Four - Add project file to the project if they are available at this point. You can always add project files later using Project Manager.

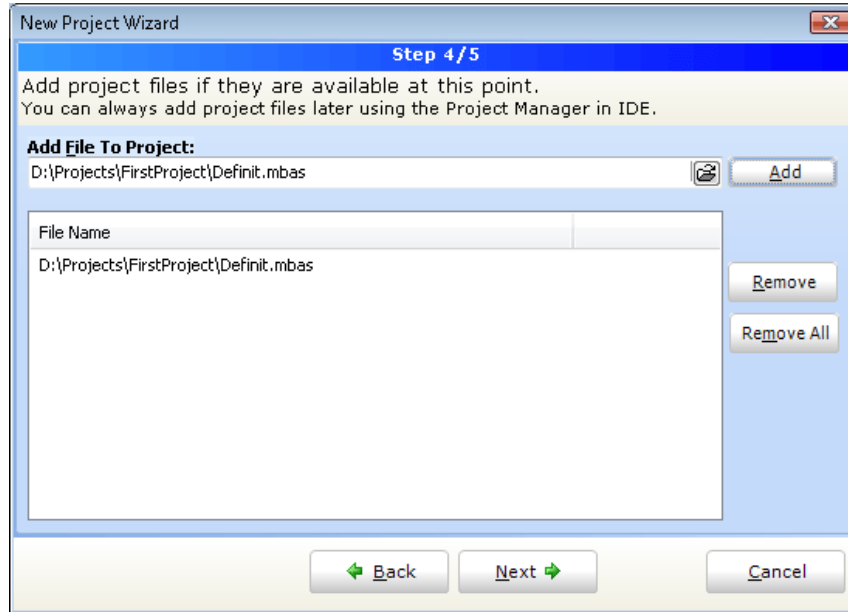

Step Five - Click Finish button to create your New Project:

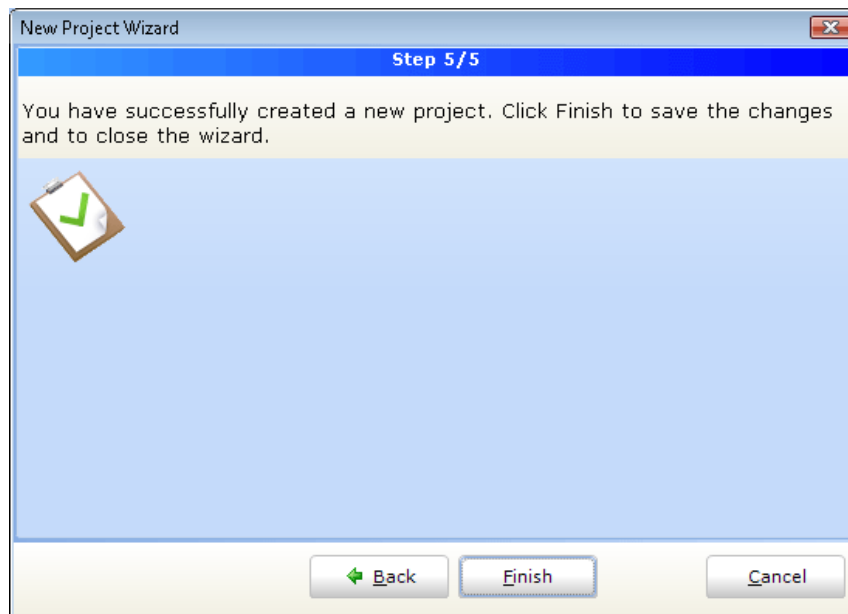

Related topics: Project Manager, Project Settings



CUSTOMIZING PROJECTS

Edit Project

You can change basic project settings in the Project Settings window. You can change chip and oscillator frequency. Any change in the Project Setting Window affects currently active project only, so in case more than one project is open, you have to ensure that exactly the desired project is set as active one in the Project Manager.

Managing Project Group

mikroBasic PRO for AVR IDE provides convenient option which enables several projects to be open simultaneously. If you have several projects being connected in some way, you can create a project group.

The project group may be saved by clicking the Save Project Group Icon  from the Project Manager window. The project group may be reopened by clicking the Open Project Group Icon . All relevant data about the project group is stored in the project group file (extension `.mpg`)

ADD/REMOVE FILES FROM PROJECT

The project can contain the following file types:

- `.mbas` source files
- `.mcl` binary files
- `.pld` project level defines files
- `image` files
- `.hex`, `.asm` and `.lst` files, see output files. These files can not be added or removed from project.
- other files

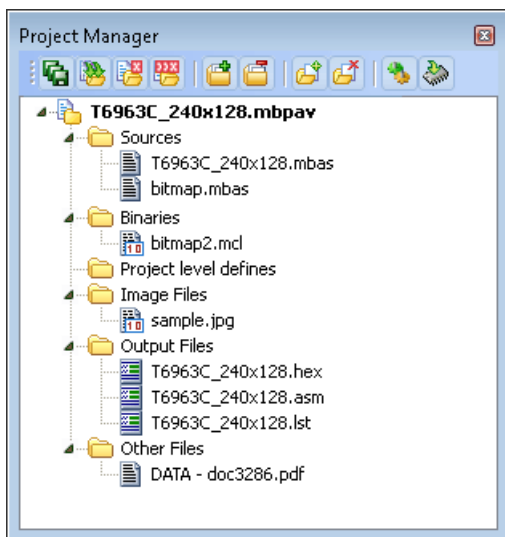

The list of relevant source files is stored in the project file (extension `.mbpav`).

To add source file to the project, click the Add File to Project Icon . Each added source file must be self-contained, i.e. it must have all necessary definitions after preprocessing.

To remove file(s) from the project, click the Remove File from Project Icon .

Note: For inclusion of the module files, use the `include` clause. See File Inclusion for more information.

Project Level Defines

Project Level Defines (`.pld`) files can also be added to project. Project level define files enable you to have defines that are visible in all source files in the project. One project may contain several `pld` files. A file must contain one definition per line, for example:

```
ANALOG
DEBUG
TEST
```

There are some predefined project level defines. See predefined project level defines

Related topics: Project Manager, Project Settings



SOURCE FILES

Source files containing Basic code should have the extension `.mbas`. The list of source files relevant to the application is stored in project file with extension `.mbpav`, along with other project information. You can compile source files only if they are part of the project.

Managing Source Files

Creating new source file

To create a new source file, do the following:

1. Select **File** › **New Unit** from the drop-down menu, or press `Ctrl+N`, or click the New File Icon  from the File Toolbar.
2. A new tab will be opened. This is a new source file. Select **File** › **Save** from the drop-down menu, or press `Ctrl+S`, or click the Save File Icon  from the File Toolbar and name it as you want.

If you use the New Project Wizard, an empty source file, named after the project with extension `.mbas`, will be created automatically. The mikroBasic PRO for AVR does not require you to have a source file named the same as the project, it's just a matter of convenience.

Opening an existing file

1. Select **File** › **Open** from the drop-down menu, or press `Ctrl+O`, or click the Open File Icon  from the File Toolbar. In Open Dialog browse to the location of the file that you want to open, select it and click the Open button.
2. The selected file is displayed in its own tab. If the selected file is already open, its current Editor tab will become active.

Printing an open file

1. Make sure that the window containing the file that you want to print is the active window.
2. Select **File** › **Print** from the drop-down menu, or press `Ctrl+P`.
3. In the Print Preview Window, set a desired layout of the document and click the OK button. The file will be printed on the selected printer.

Saving file

1. Make sure that the window containing the file that you want to save is the active window.
2. Select **File** › **Save** from the drop-down menu, or press Ctrl+S, or click the Save File Icon  from the File Toolbar.

Saving file under a different name

1. Make sure that the window containing the file that you want to save is the active window.
2. Select **File** › **Save As** from the drop-down menu. The New File Name dialog will be displayed.
3. In the dialog, browse to the folder where you want to save the file.
4. In the File Name field, modify the name of the file you want to save.
5. Click the Save button.

Closing file

1. Make sure that the tab containing the file that you want to close is the active tab.
2. Select **File** › **Close** from the drop-down menu, or right click the tab of the file that you want to close and select **Close** option from the context menu.
3. If the file has been changed since it was last saved, you will be prompted to save your changes.

Related topics:File Menu, File Toolbar, Project Manager, Project Settings,

CLEAN PROJECT FOLDER



Clean Project Folder

This menu gives you option to choose which files from your current project you want to delete.

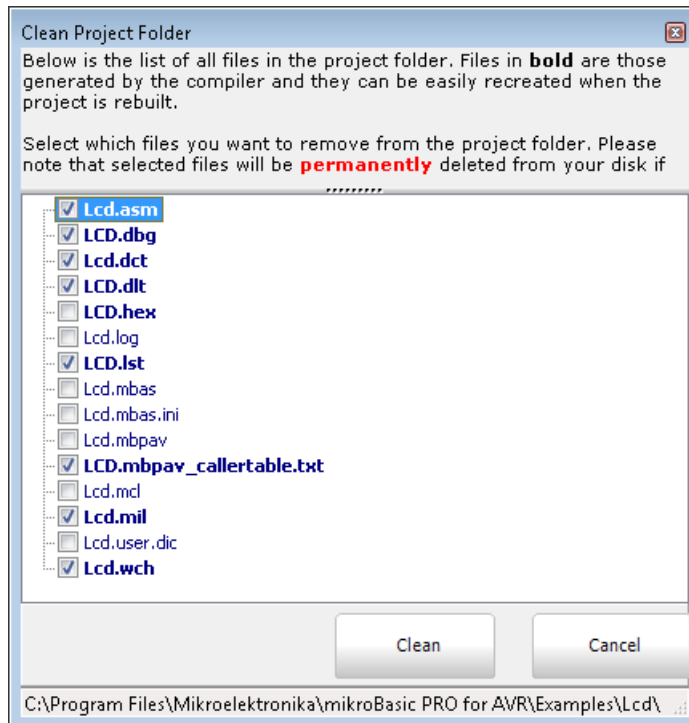
Files marked in **bold** can be easily recreated by building a project. Other files should be marked for deletion only with a great care, because IDE cannot recover them.



COMPILATION

When you have created the project and written the source code, it's time to compile it. Select **Project** > **Build** from the drop-down menu, or click the Build Icon  from the Project Toolbar. If more more than one project is open you can compile all open projects by selecting **Project** > **Build All** from the drop-down menu, or click the Build All Icon  from the Project Toolbar.

Progress bar will appear to inform you about the status of compiling. If there are some errors, you will be notified in the Error Window. If no errors are encountered, the mikroBasic PRO for AVR will generate output files.

Output Files

Upon successful compilation, the mikroBasic PRO for AVR will generate output files in the project folder (folder which contains the project file `.mbpav`). Output files are summarized in the table below:

Format	Description	File Type
Intel HEX	Intel style hex records. Use this file to program AVR MCU.	<code>.hex</code>
Binary	mikro Compiled Library. Binary distribution of application that can be included in other projects.	<code>.mcl</code>
List File	Overview of AVR memory allotment: instruction addresses, registers, routines and labels.	<code>.lst</code>
Assembler File	Human readable assembly with symbolic names, extracted from the List File.	<code>.asm</code>

Assembly View

After compiling the program in the mikroBasic PRO for AVR, you can click the View Assembly icon  or select **Project** > **View Assembly** from the drop-down menu to review the generated assembly code (`.asm` file) in a new tab window. Assembly is human-readable with symbolic names.

Related topics:Project Menu, Project Toolbar, Error Window, Project Manager, Project Settings

ERROR MESSAGES

Compiler Error Messages:

- "%s" is not valid identifier.
- Unknown type "%s".
- Identifier "%s" was not declared.
- Syntax error: Expected "%s" but "%s" found.
- Argument is out of range "%s".
- Syntax error in additive expression.
- File "%s" not found.
- Invalid command "%s".
- Not enough parameters.
- Too many parameters.
- Too many characters.
- Actual and formal parameters must be identical.
- Invalid ASM instruction: "%s".
- Identifier "%s" has been already declared in "%s".
- Syntax error in multiplicative expression.
- Definition file for "%s" is corrupted.
- ORG directive is currently supported for interrupts only.
- Not enough ROM.
- Not enough RAM.
- External procedure "%s" used in "%s" was not found.
- Internal error: "%s".
- Unit cannot recursively use itself.
- "%s" cannot be used out of loop.
- Supplied and formal parameters do not match ("%s" to "%s").
- Constant cannot be assigned to.
- Constant array must be declared as global.
- Incompatible types ("%s" to "%s").
- Too many characters ("%s").
- Soft_Uart cannot be initialized with selected baud rate/device clock.
- Main label cannot be used in modules.
- Break/Continue cannot be used out of loop.
- Preprocessor Error: "%s".
- Expression is too complicated.
- Duplicated label "%s".
- Complex type cannot be declared here.
- Record is empty.
- Unknown type "%s".
- File not found "%s".
- Constant argument cannot be passed by reference.
- Pointer argument cannot be passed by reference.

- Operator "%s" not applicable to these operands "%s".
- Exit cannot be called from the main block.
- Complex type parameter must be passed by reference.
- Error occurred while compiling "%s".
- Recursive types are not allowed.
- Adding strings is not allowed, use "strcat" procedure instead.
- Cannot declare pointer to array, use pointer to structure which has array field.
- Return value of the function "%s" is not defined.
- Assignment to for loop variable is not allowed.
- "%s" is allowed only in the main program.
- Start address of "%s" has already been defined.
- Simple constant cannot have fixed address.
- Invalid date/time format.
- Invalid operator "%s".
- File "%s" is not accessible.
- Forward routine "%s" is missing implementation.
- ";" is not allowed before "else".
- Not enough elements: expected "%s", but "%s" elements found.
- Too many elements: expected "%s" elements.
- "external" is allowed for global declarations only.
- Destination size ("%s") does not match source size ("%s").
- Routine prototype is different from previous declaration.
- Division by zero.
- Uart module cannot be initialized with selected baud rate/device clock.
- % cannot be of "%s" type.

Warning Messages:

- Implicit typecast of integral value to pointer.
- Library "%s" was not found in search path.
- Interrupt context saving has been turned off.
- Variable "%s" is not initialized.
- Return value of the function "%s" is not defined.
- Identifier "%s" overrides declaration in unit "%s".
- Generated baud rate is "%s" bps (error = "%s" percent).
- Result size may exceed destination array size.
- Infinite loop.
- Implicit typecast performed from "%s" to "%s".
- Source size ("%s") does not match destination size ("%s").
- Array padded with zeros ("%s") in order to match declared size ("%s").
- Suspicious pointer conversion.

Hint Messages:

- Constant "%s" has been declared, but not used.
- Variable "%s" has been declared, but not used.
- Unit "%s" has been recompiled.
- Variable "%s" has been eliminated by optimizer.
- Compiling unit "%s".

SOFTWARE SIMULATOR OVERVIEW

The Source-level Software Simulator is an integral component of the mikroBasic PRO for AVR environment. It is designed to simulate operations of the AVR MCUs and assist the users in debugging Basic code written for these devices.

After you have successfully compiled your project, you can run the Software Simulator by selecting **Run > Start Debugger** from the drop-down menu, or by clicking the Start Debugger Icon  from the Debugger Toolbar. Starting the Software Simulator makes more options available: Step Into, Step Over, Step Out, Run to Cursor, etc. Line that is to be executed is color highlighted (blue by default).

Note: The Software Simulator simulates the program flow and execution of instruction lines, but it cannot fully emulate AVR device behavior, i.e. it doesn't update timers, interrupt flags, etc.

Watch Window

The Software Simulator Watch Window is the main Software Simulator window which allows you to monitor program items while simulating your program. To show the Watch Window, select **View > Debug Windows > Watch** from the drop-down menu.

The Watch Window displays variables and registers of the MCU, along with their addresses and values.

There are two ways of adding variable/register to the watch list:

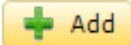
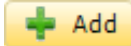
- by its real name (variable's name in "Basic" code). Just select desired variable/register from **Select variable from list** drop-down menu and click the Add Button  .
- by its name ID (assembly variable name). Simply type name ID of the variable/register you want to display into **Search the variable by assembly name** box and click the Add Button  .

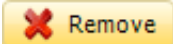
Variables can also be removed from the Watch window, just select the variable that you want to remove and then click the Remove Button  .

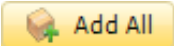
Add All Button  adds all variables.

Remove All Button  **Remove All** removes all variables.

You can also expand/collapse complex variables, i.e. struct type variables, strings...

Values are updated as you go through the simulation. Recently changed items are colored red.

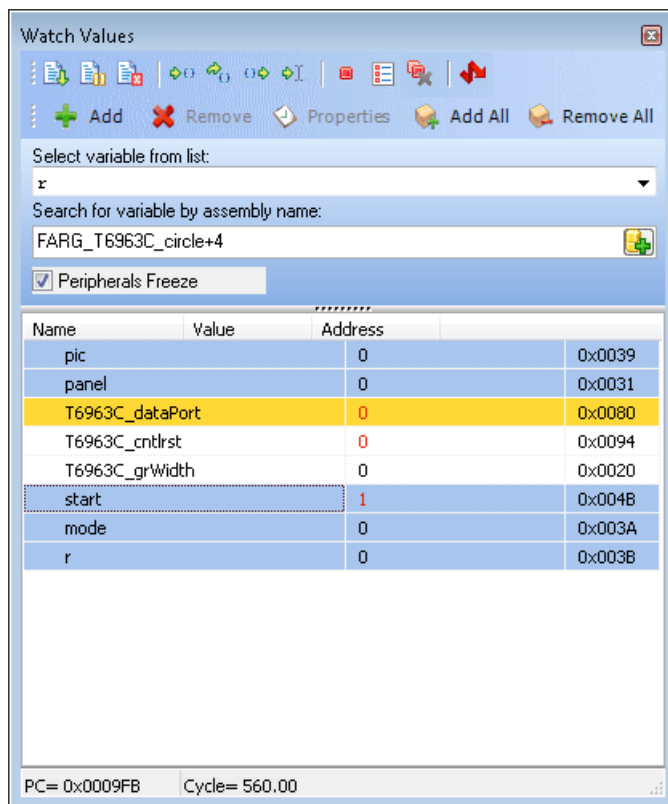

Double clicking a variable or clicking the Properties Button  **Properties** opens the Edit Value window in which you can assign a new value to the selected variable/register. Also, you can choose the format of variable/register representation between decimal, hexadecimal, binary, float or character. All representations except float are unsigned by default. For signed representation click the check box next to the **Signed** label.

An item's value can be also changed by double clicking item's value field and typing the new value directly.

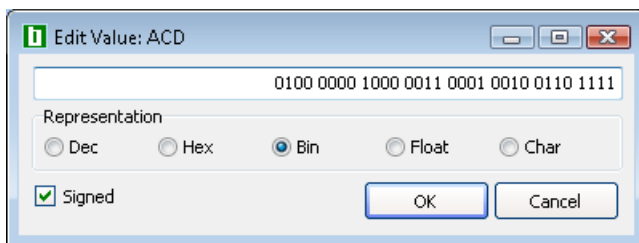

Stopwatch Window

The Software Simulator Stopwatch Window is available from the drop-down menu, **View > Debug Windows > Stopwatch**.

The Stopwatch Window displays a current count of cycles/time since the last Software Simulator action. Stopwatch measures the execution time (number of cycles) from the moment Software Simulator has started and can be reset at any time. Delta represents the number of cycles between the lines where Software Simulator action has started and ended.

Note: The user can change the clock in the Stopwatch Window, which will recalculate values for the latest specified frequency. Changing the clock in the Stopwatch Window does not affect actual project settings – it only provides a simulation.

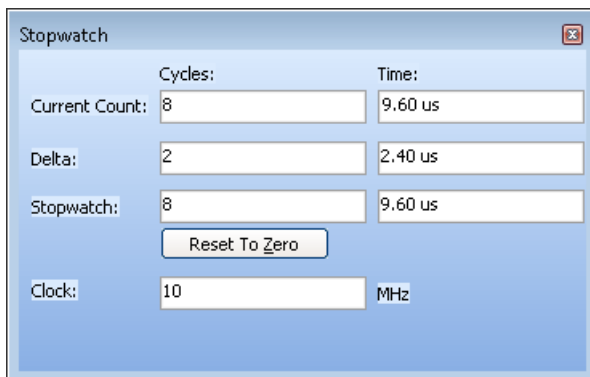









RAM Window

The Software Simulator RAM Window is available from the drop-down menu, **View** › **Debug Windows** › **RAM**.

The RAM Window displays a map of MCU's RAM, with recently changed items colored red. You can change value of any field by double-clicking it.

	00	01	02	03	04	05	06	07	08	09	0A	0B	0C	0D	0E	0F	ASCII
0000	00	00	00	00	00	00	00	00	00	00	00	00	00	00	00	00
0010	00	00	00	00	00	00	00	00	00	00	00	04	00	00	00	00	...
0020	00	00	00	00	00	00	00	00	00	00	00	00	00	00	00	00
0030	00	00	00	00	00	00	00	00	00	00	00	00	00	00	00	00
0040	00	00	00	00	00	00	00	00	00	00	00	00	00	00	00	00
0050	00	00	00	00	00	00	00	00	00	00	00	00	00	5F	04	00	...
0060	00	00	00	00	00	00	00	00	00	00	00	00	00	00	00	00
0070	00	00	00	00	00	00	00	00	00	00	00	00	00	00	00	00
0080	00	00	00	00	00	00	00	00	00	00	00	00	00	00	00	00
0090	00	00	00	00	00	00	00	00	00	00	00	00	00	00	00	00
00A0	00	00	00	00	00	00	00	00	00	00	00	00	00	00	00	00
00B0	00	00	00	00	00	00	00	00	00	00	00	00	00	00	00	00
00C0	00	00	00	00	00	00	00	00	00	00	00	00	00	00	00	00
00D0	00	00	00	00	00	00	00	00	00	00	00	00	00	00	00	00
00E0	00	00	00	00	00	00	00	00	00	00	00	00	00	00	00	00

SOFTWARE SIMULATOR OPTIONS

Name	Description	Function Key	Toolbar Icon
Start Debugger	Start Software Simulator.	[F9]	
Run/Pause Debugger	Run or pause Software Simulator.	[F6]	
Stop Debugger	Stop Software Simulator.	[Ctrl+F2]	
Toggle Breakpoints	Toggle breakpoint at the current cursor position. To view all breakpoints, select Run > View Breakpoints from the drop-down menu. Double clicking an item in the Breakpoints Window List locates the breakpoint.	[F5]	
Run to cursor	Execute all instructions between the current instruction and cursor position.	[F4]	
Step Into	Execute the current Basic (single or multi-cycle) instruction, then halt. If the instruction is a routine call, enter the routine and halt at the first instruction following the call.	[F7]	
Step Over	Execute the current Basic (single or multi-cycle) instruction, then halt.	[F8]	
Step Out	Execute all remaining instructions in the current routine, return and then halt.	[Ctrl+F8]	

Related topics: Run Menu, Debug Toolbar

CREATING NEW LIBRARY

mikroBasic PRO for AVR allows you to create your own libraries. In order to create a library in mikroBasic PRO for AVR follow the steps below:

1. Create a new Basic source file, see Managing Source Files
2. Save the file in one of the subfolders of the compiler's Uses folder (LTE64kW or GT64kW, see note on the end of the page):

```
DriveName:\Program Files\Mikroelektronika\mikroBasic PRO for  
AVR\Uses\LTE64kW\__Lib_Example.mbas
```

3. Write a code for your library and save it.
4. Add `__Lib_Example` file in some project, see Project Manager. Recompile the project.

If you wish to use this library for all MCUs, then you should go to **Tools > Options > Output settings**, and check **Build all files as library** box.

This will build libraries in a common form which will work with all MCUs. If this box is not checked, then library will be built for selected MCU.

Bear in mind that compiler will report an error if a library built for specific MCU is used for another one.

5. Compiled file `__Lib_Example.mcl` should appear in `..\mikroBasic PRO for AVR\Uses\LTE64kW\` folder.
6. Open the definition file for the MCU that you want to use. This file is placed in the compiler's Defs folder:

```
DriveName:\Program Files\Mikroelektronika\mikroBasic PRO for  
AVR\Defs\ and it is named MCU_NAME.mlk, for example ATMEGA16.mlk
```

7. Add the the following segment of code to `<LIBRARIES>` node of the definition file (definition file is in XML format):

```
<LIB>  
  <ALIAS>Example_Library</ALIAS>  
  <FILE>__Lib_Example</FILE>  
  <TYPE>REGULAR</TYPE>  
</LIB>
```

8. Add Library to mlk file for each MCU that you want to use with your library.
9. Click Refresh button in Library Manager
10. `Example_Library` should appear in the Library manager window.

Multiple Library Versions

Library Alias represents unique name that is linked to corresponding Library .mcl file. For example UART library for ATMEGA16 is different from UART library for ATMEGA128 MCU. Therefore, two different UART Library versions were made, see mlk files for these two MCUs. Note that these two libraries have the same Library Alias (UART) in both mlk files. This approach enables you to have identical representation of UART library for both MCUs in Library Manager.

Note: In the Uses folder, there should be two subfolders, LTE64kW and GT64kW, depending on the Flash memory size of the desired MCU. See AVR Specifics for a detailed information regarding this subject.

Related topics: Library Manager, Project Manager, Managing Source Files

CHAPTER

3

mikroBasic PRO for AVR Specifics

The following topics cover the specifics of mikroBasic PRO for AVR compiler:

- Basic Standard Issues
- Predefined Globals and Constants
- Accessing Individual Bits
- Interrupts
- AVR Pointers
- Linker Directives
- Built-in Routines
- Code Optimization

BASIC STANDARD ISSUES

Divergence from the Basic Standard

Function recursion is not supported because of no easily-usable stack and limited memory AVR Specific

Basic Language Exstensions

mikroBasic PRO for AVR has additional set of keywords that do not belong to the standard Basic language keywords:

- `code`
- `data`
- `io`
- `rx`
- `register`
- `at`
- `sbit`
- `bit`
- `sfr`

Related topics: Keywords, AVR Specific

PREDEFINED GLOBALS AND CONSTANTS

In order to facilitate AVR programming, mikroBasic PRO for AVR implements a number of predefined globals and constants.

SFRs and related constants

All AVR SFRs are implicitly declared as global variables of `volatile word` type. These identifiers have an external linkage, and are visible in the entire project. When creating a project, the mikroBasic PRO for AVR will include an appropriate (*.mbas) file from defs folder, containing declarations of available SFRs and constants (such as PORTB, ADPCFG, etc). All identifiers are in upper case, identical to nomenclature in the Microchip datasheets.

For a complete set of predefined globals and constants, look for “Defs” in the mikroBasic PRO for AVR installation folder, or probe the Code Assistant for specific letters (Ctrl+Space in the Code Editor).

Math constants

In addition, several commonly used math constants are predefined in mikroBasic PRO for AVR:

```
PI           = 3.1415926
PI_HALF     = 1.5707963
TWO_PI      = 6.2831853
E           = 2.7182818
```

Predefined project level defines

These defines are based on a value that you have entered/edited in the current project, and it is equal to the name of selected device for the project.

If ATmega16 is selected device, then ATmega16 token will be defined as 1, so it can be used for conditional compilation:

```
#IFDEF ATmega16
...
#endif
```

Related topics: Project level defines

ACCESSING INDIVIDUAL BITS

The mikroBasic PRO for AVR allows you to access individual bits of 8-bit variables. It also supports sbit and bit data types

Accessing Individual Bits Of Variables

To access the individual bits, simply use the direct member selector (.) with a variable, followed by one of identifiers B0, B1, ... , B7, or 0, 1, ... 7, with 7 being the most significant bit :

```
// Clear bit 0 on PORTA  
PORTA.B0 = 0
```

```
// Clear bit 5 on PORTB  
PORTB.5 = 0
```

There is no need of any special declarations. This kind of selective access is an intrinsic feature of mikroBasic PRO for AVR and can be used anywhere in the code. Identifiers B0–B7 are not case sensitive and have a specific namespace. You may override them with your own members B0–B7 within any given structure.

See Predefined Globals and Constants for more information on register/bit names.

sbit type

The mikroBasic PRO for AVR compiler has sbit data type which provides access to bit-addressable SFRs. You can access them in several ways:

```
dim LEDA as sbit at PORTA.B0  
dim Name as sbit at sfr-name.B<bit-position>
```

```
dim LEDB as sbit at PORTB.0  
dim Name as sbit at sfr-name.<bit-position>
```

bit type

The mikroBasic PRO for AVR compiler provides a `bit` data type that may be used for variable declarations. It can not be used for argument lists, and function-return values.

```
dim bf as bit ' bit variable
```

There are no pointers to bit variables:

```
dim ptr as ^bit ' invalid
```

An array of type bit is not valid:

```
dim arr as array[5] of bit ' invalid
```

Note :

- Bit variables can not be initialized.
- Bit variables can not be members of structures.
- Bit variables do not have addresses, therefore unary operator `@` (address of) is not applicable to these variables.

Related topics: Predefined globals and constants

INTERRUPTS

AVR derivates acknowledges an interrupt request by executing a hardware generated CALL to the appropriate servicing routine ISRs. ISRs are organized in IVT. ISR is defined as a standard function but with the `org` directive afterwards which connects the function with specific interrupt vector. For example `org 0x000B` is IVT address of Timer/Counter 2 Overflow interrupt source of the ATMEGA16. For more information on interrupts and IVT refer to the specific data sheet.

Function Calls from Interrupt

Calling functions from within the interrupt routine is allowed. The compiler takes care about the registers being used, both in "interrupt" and in "main" thread, and performs "smart" context-switching between them two, saving only the registers that have been used in both threads. It is not recommended to use function call from interrupt. In case of doing that take care of stack depth.

```
sub procedure Interrupt() org 0x16
    RS485Master_Receive(dat)
end sub
```

Most of the MCUs can access interrupt service routines directly, but some can not reach interrupt service routines if they are allocated on addresses greater than 2K from the IVT. In this case, compiler automatically creates Goto table, in order to jump to such interrupt service routines.

These principles can be explained on the picture below :

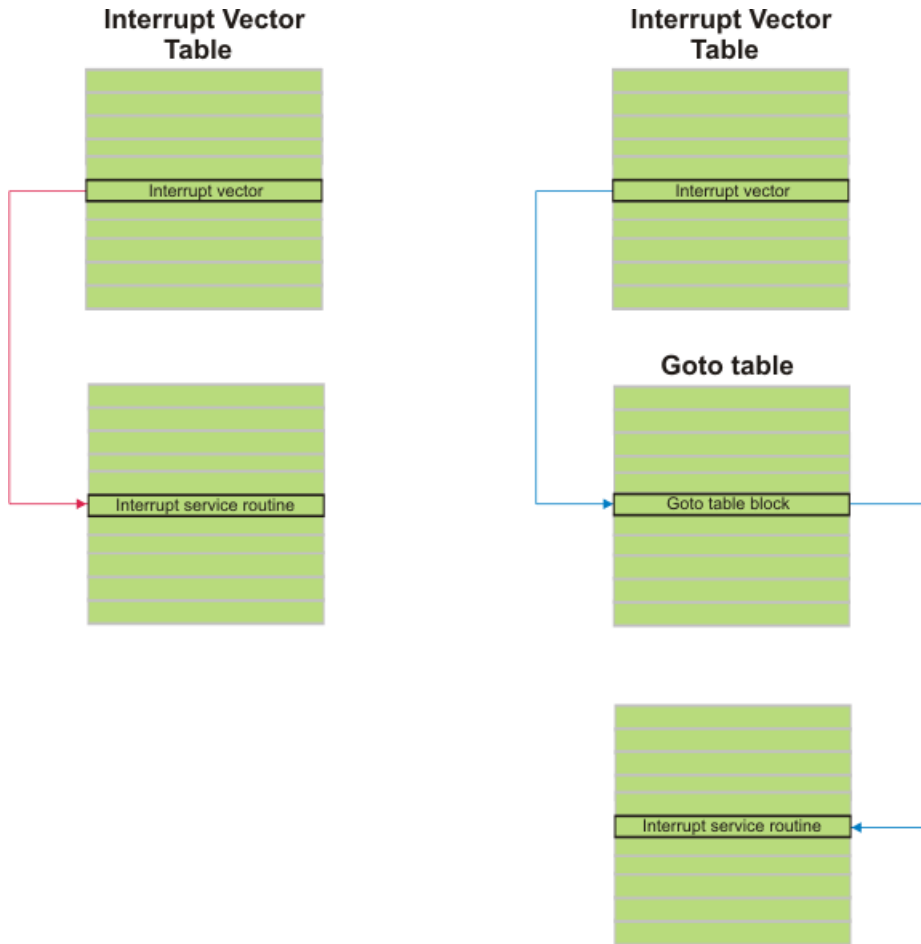

Direct accessing interrupt service routine and accessing interrupt service routine via Goto table.

LINKER DIRECTIVES

mikroBasic PRO for AVR uses internal algorithm to distribute objects within memory. If you need to have a variable or routine at the specific predefined address, use the linker directives `absolute` and `org`.

Note: You must specify an even address when using the linker directives.

Directive `absolute`

The directive `absolute` specifies the starting address in RAM for a variable. If the variable spans more than 1 word (16-bit), higher words will be stored at the consecutive locations.

The `absolute` directive is appended to the declaration of a variable:

```
dim x as word absolute 0x32
' Variable x will occupy 1 word (16 bits) at address 0x32

dim y as longint absolute 0x34
' Variable y will occupy 2 words at addresses 0x34 and 0x36
```

Be careful when using absolute directive, as you may overlap two variables by accident. For example:

```
dim i as word absolute 0x42
' Variable i will occupy 1 word at address 0x42;

dim jj as longint absolute 0x40
' Variable will occupy 2 words at 0x40 and 0x42; thus,
' changing i changes jj at the same time and vice versa
```

Note: You must specify an even address when using the directive `absolute`.

Directive `org`

The directive `org` specifies the starting address of a routine in ROM. It is appended to the declaration of routine. For example:

```
sub procedure proc(dim par as word) org 0x200
' Procedure will start at the address 0x200;
...
end sub
```

Note: You must specify an even address when using the directive `org`.

BUILT-IN ROUTINES

The mikroBasic PRO for AVR compiler provides a set of useful built-in utility functions.

The `Lo`, `Hi`, `Higher`, `Highest` routines are implemented as macros. If you want to use these functions you must include `built_in.h` header file (located in the `include` folder of the compiler) into your project.

The `Delay_us` and `Delay_ms` routines are implemented as “inline”; i.e. code is generated in the place of a call, so the call doesn’t count against the nested call limit.

The `Vdelay_ms`, `Delay_Cyc` and `Get_Fosc_kHz` are actual Basic routines. Their sources can be found in `Delays.mbas` file located in the `uses` folder of the compiler.

- `Lo`
- `Hi`
- `Higher`
- `Highest`

- `Inc`
- `Dec`

- `Delay_us`
- `Delay_ms`
- `Vdelay_ms`
- `Delay_Cyc`

- `Clock_Khz`
- `Clock_Mhz`

- `SetFuncCall`

Lo

Prototype	<code>sub function Lo(number as longint) as byte</code>
Returns	Lowest 8 bits (byte) of <code>number</code> , bits 7..0.
Description	Function returns the lowest byte of <code>number</code> . Function does not interpret bit patterns of <code>number</code> – it merely returns 8 bits as found in register. This is an “inline” routine; code is generated in the place of the call, so the call doesn’t count against the nested call limit.
Requires	Arguments must be variable of scalar type (i.e. Arithmetic Types and Pointers).
Example	<pre>d = 0x1AC30F4 tmp = Lo(d) ' Equals 0xF4</pre>

Hi

Prototype	<code>sub function Hi(number as longint) as byte</code>
Returns	Returns next to the lowest byte of <code>number</code> , bits 8..15.
Description	Function returns next to the lowest byte of <code>number</code> . Function does not interpret bit patterns of <code>number</code> – it merely returns 8 bits as found in register. This is an “inline” routine; code is generated in the place of the call, so the call doesn’t count against the nested call limit.
Requires	Arguments must be variable of scalar type (i.e. Arithmetic Types and Pointers).
Example	<pre>d = 0x1AC30F4 tmp = Hi(d) ' Equals 0x30</pre>

Higher

Prototype	<code>sub function Higher(number as longint) as byte</code>
Returns	Returns next to the highest byte of <code>number</code> , bits 16..23.
Description	Function returns next to the highest byte of <code>number</code> . Function does not interpret bit patterns of <code>number</code> – it merely returns 8 bits as found in register. This is an “inline” routine; code is generated in the place of the call, so the call doesn’t count against the nested call limit.
Requires	Arguments must be variable of scalar type (i.e. Arithmetic Types and Pointers).
Example	<pre>d = 0x1AC30F4 tmp = Higher(d) ' Equals 0xAC</pre>

Highest

Prototype	<code>sub function Highest(number as longint) as byte</code>
Returns	Returns the highest byte of <code>number</code> , bits 24..31.
Description	Function returns the highest byte of <code>number</code> . Function does not interpret bit patterns of <code>number</code> – it merely returns 8 bits as found in register. This is an “inline” routine; code is generated in the place of the call, so the call doesn’t count against the nested call limit.
Requires	Arguments must be variable of scalar type (i.e. Arithmetic Types and Pointers).
Example	<pre>d = 0x1AC30F4 tmp = Highest(d) ' Equals 0x01</pre>

Inc

Prototype	<code>sub procedure Inc(dim byref par as longint)</code>
Returns	Nothing.
Description	Increases parameter <code>par</code> by 1.
Requires	Nothing.
Example	<pre>p = 4 Inc(p) ' p is now 5</pre>

Dec

Prototype	<code>sub procedure Dec(dim byref par as longint)</code>
Returns	Nothing.
Description	Decreases parameter <code>par</code> by 1.
Requires	Nothing.
Example	<pre>p = 4 Dec(p) ' p is now 3</pre>

Delay_us

Prototype	<code>sub procedure Delay_us(const time_in_us as longword)</code>
Returns	Nothing.
Description	Creates a software delay in duration of <code>time_in_us</code> microseconds (a constant). Range of applicable constants depends on the oscillator frequency. This is an “inline” routine; code is generated in the place of the call, so the call doesn’t count against the nested call limit.
Requires	Nothing.
Example	<code>Delay_us(1000) ' One millisecond pause</code>

Delay_ms

Prototype	<code>sub procedure Delay_ms(const time_in_ms as longword)</code>
Returns	Nothing.
Description	Creates a software delay in duration of <code>time_in_ms</code> milliseconds (a constant). Range of applicable constants depends on the oscillator frequency. This is an “inline” routine; code is generated in the place of the call, so the call doesn’t count against the nested call limit.
Requires	Nothing.
Example	<code>Delay_ms(1000) ' One second pause</code>

Vdelay_ms

Prototype	<code>sub procedure Vdelay_ms(time_in_ms as word)</code>
Returns	Nothing.
Description	Creates a software delay in duration of <code>time_in_ms</code> milliseconds (a variable). Generated delay is not as precise as the delay created by <code>Delay_ms</code> . Note that <code>Vdelay_ms</code> is library function rather than a built-in routine; it is presented in this topic for the sake of convenience.
Requires	Nothing.
Example	<code>pause = 1000 ' ... Vdelay_ms(pause) ' ~ one second pause</code>

Delay_Cyc

Prototype	<code>sub procedure Delay_Cyc(Cycles_div_by_10 as byte)</code>
Returns	Nothing.
Description	Creates a delay based on MCU clock. Delay lasts for 10 times the input parameter in MCU cycles. Note that <code>Delay_Cyc</code> is library function rather than a built-in routine; it is presented in this topic for the sake of convenience. There are limitations for <code>Cycles_div_by_10</code> value. Value <code>Cycles_div_by_10</code> must be between 2 and 257.
Requires	Nothing.
Example	<code>Delay_Cyc(10) ' Hundred MCU cycles pause</code>

Clock_KHz

Prototype	<code>sub function Clock_KHz() as word</code>
Returns	Device clock in KHz, rounded to the nearest integer.
Description	Function returns device clock in KHz, rounded to the nearest integer. This is an “inline” routine; code is generated in the place of the call, so the call doesn’t count against the nested call limit.
Requires	Nothing.
Example	<code>clk = Clock_kHz()</code>

Clock_MHz

Prototype	<code>sub function Clock_MHz() as byte</code>
Returns	Device clock in MHz, rounded to the nearest integer.
Description	Function returns device clock in MHz, rounded to the nearest integer. This is an “inline” routine; code is generated in the place of the call, so the call doesn’t count against the nested call limit.
Requires	Nothing.
Example	<code>clk = Clock_Mhz()</code>

SetFuncCall

Prototype	<code>sub procedure SetFuncCall(FuncName as string)</code>
Returns	Nothing.
Description	<p>Function informs the linker about a specific routine being called. SetFuncCall has to be called in a routine which accesses another routine via a pointer.</p> <p>Function prepares the caller tree, and informs linker about the procedure usage, making it possible to link the called routine.</p>
Requires	Nothing.
Example	<pre> sub procedure first(p, q as byte) ... SetFuncCall(second) ' let linker know that we will call the routine 'second' ... end sub </pre>

CODE OPTIMIZATION

Optimizer has been added to extend the compiler usability, cut down the amount of code generated and speed-up its execution. The main features are:

Constant folding

All expressions that can be evaluated in the compile time (i.e. are constant) are being replaced by their results. (3 + 5 -> 8);

Constant propagation

When a constant value is being assigned to a certain variable, the compiler recognizes this and replaces the use of the variable by constant in the code that follows, as long as the value of a variable remains unchanged.

Copy propagation

The compiler recognizes that two variables have the same value and eliminates one of them further in the code.

Value numbering

The compiler "recognizes" if two expressions yield the same result and can therefore eliminate the entire computation for one of them.

"Dead code" elimination

The code snippets that are not being used elsewhere in the programme do not affect the final result of the application. They are automatically removed.

Stack allocation

Temporary registers ("Stacks") are being used more rationally, allowing VERY complex expressions to be evaluated with a minimum stack consumption.

Local vars optimization

No local variables are being used if their result does not affect some of the global or volatile variables.

Better code generation and local optimization

Code generation is more consistent and more attention is paid to implement specific solutions for the code "building bricks" that further reduce output code size.

CHAPTER

4

AVR Specifics

Types Efficiency

First of all, you should know that AVR ALU, which performs arithmetic operations, is optimized for working with bytes. Although mikroBasic PRO for AVR is capable of handling very complex data types, AVR may choke on them, especially if you are working on some of the older models. This can dramatically increase the time needed for performing even simple operations. Universal advice is to use the smallest possible type in every situation. It applies to all programming in general, and doubly so with microcontrollers. Types efficiency is determined by the part of RAM memory that is used to store a variable/constant.

Nested Calls Limitations

There are no Nested Calls Limitations, except by RAM size. A Nested call represents a function call to another function within the function body. With each function call, the stack increases for the size of the returned address. Number of nested calls is equal to the capacity of RAM which is left out after allocation of all variables.

Important notes:

- There are many different types of derivatives, so it is necessary to be familiar with characteristics and special features of the microcontroller in you are using.
- Some of the AVR MCUs have hardware multiplier. Due to this, be sure to pay attention when porting code from one MCU to another, because compiled code can vary by its size.
- Not all microcontrollers share the same instruction set. It is advisable to carefully read the instruction set of the desired MCU, before you start writing your code. Compiler automatically takes care of appropriate instruction set, and if unappropriate asm instruction is used in in-line assembly, compiler will report an error.
- Program counter size is MCU dependent. Thus, there are two sets of libraries :
 - MCUs with program counter size larger than 16 bits (flash memory size larger than 128kb)
 - MCUs with program counter size less or equal 16 bits (flash memory size smaller than 128kb)
- Assembly SPM instruction and its derivatives must reside in Boot Loader section of program memory.
- Part of flash memory can be dedicated to Boot Loader code. For details, refer to AVR memory organization.

Related topics: mikroBasic PRO for AVR specifics, AVR memory organization

AVR MEMORY ORGANIZATION

The AVR microcontroller's memory is divided into Program Memory and Data Memory. Program Memory (ROM) is used for permanent saving program being executed, while Data Memory (RAM) is used for temporarily storing and keeping intermediate results and variables.

Program Memory (ROM)

Program Memory (ROM) is used for permanent saving program (CODE) being executed, and it is divided into two sections, Boot Program section and the Application Program section. The size of these sections is configured by the BOOTSZ fuse. These two sections can have different level of protection since they have different sets of Lock bits.

Depending on the settings made in compiler, program memory may also used to store a constant variables. The AVR executes programs stored in program memory only. `code` memory type specifier is used to refer to program memory.

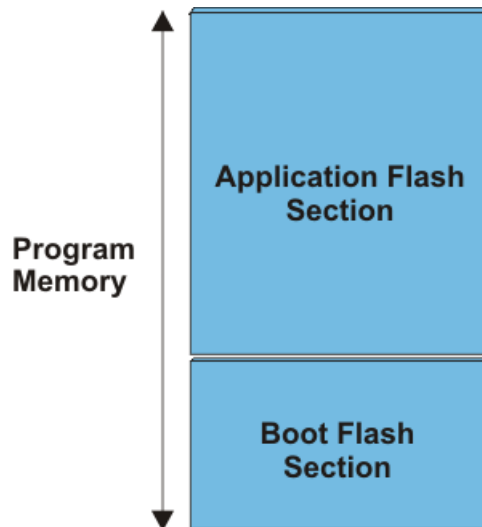

Data Memory

Data memory consists of :

- Rx space
- I/O Memory
- Extended I/O Memory (MCU dependent)
- Internal SRAM

Rx space consists of 32 general purpose working 8-bit registers (R0-R31). These registers have the shortest (fastest) access time, which allows single-cycle Arithmetic Logic Unit (ALU) operation.

I/O Memory space contains addresses for CPU peripheral function, such as Control registers, SPI, and other I/O functions.

Due to the complexity, some AVR microcontrollers with more peripherals have Extended I/O memory, which occupies part of the internal SRAM. Extended I/O memory is MCU dependent.

Storing data in I/O and Extended I/O memory is handled by the compiler only. Users can not use this memory space for storing their data.

Internal SRAM (Data Memory) is used for temporarily storing and keeping intermediate results and variables (static link and dynamic link).

There are four memory type specifiers that can be used to refer to the data memory: rx, data, io, sfr i register.

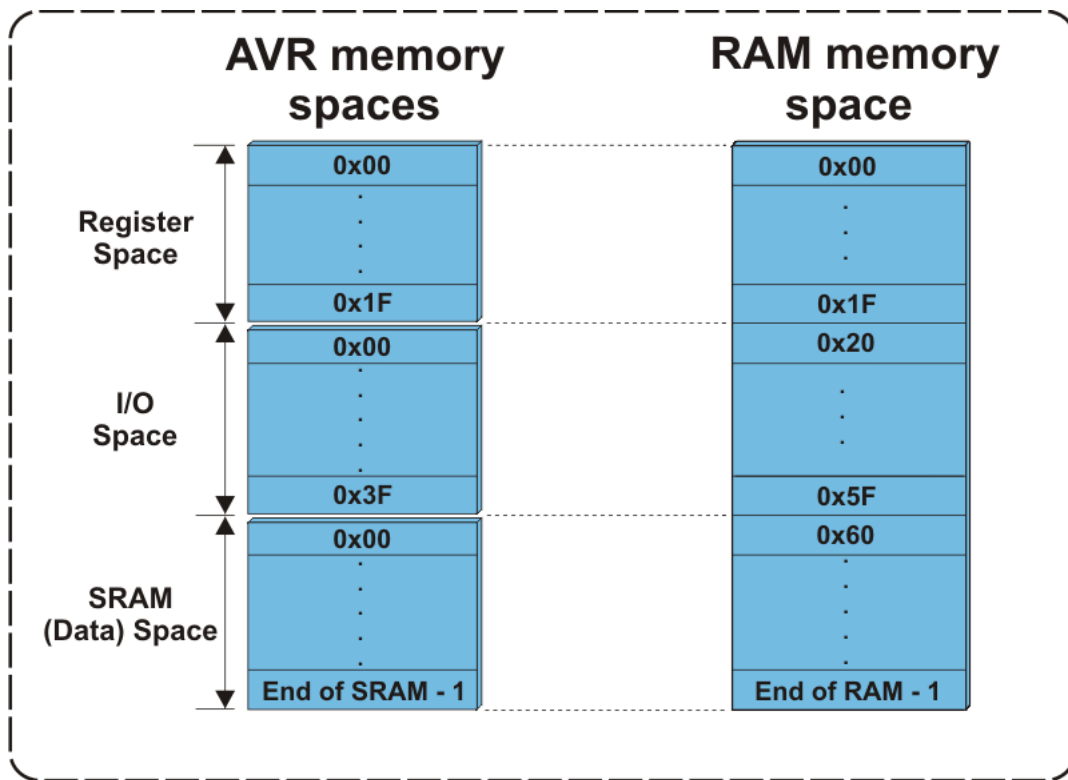

Related topics: Accessing individual bits, SFRs, Memory type specifiers

MEMORY TYPE SPECIFIERS

The mikroBasic PRO for AVR supports usage of all memory areas. Each variable may be explicitly assigned to a specific memory space by including a memory type specifier in the declaration, or implicitly assigned.

The following memory type specifiers can be used:

- code
- data
- rx
- io
- sfr
- register

Memory type specifiers can be included in variable declaration.
For example:

```
dim data_buffer as byte data      ' puts data_buffer in data ram
const txt = "Enter parameter" code ' puts text in program memory
```

code

Description	The code memory type may be used for allocating constants in program memory.
Example	<pre>' puts txt in program memory const txt = "Enter parameter" code</pre>

data

Description	This memory specifier is used when storing variable to the internal data SRAM.
Example	<pre>' puts data_buffer in data ram dim data_buffer as byte data</pre>

rx

Description	This memory specifier allows variable to be stored in the Rx space (Register file). Note: In most of the cases, there will be enough space left for the user variables in the Rx space. However, since compiler uses Rx space for storing temporary variables, it might happen that user variables will be stored in the internal data SRAM, when writing complex programs.
Example	<pre>' puts y in Rx space dim y as char rx</pre>

io

Description	This memory specifier allows user to access the I/O Memory space.
Example	<code>' put io_buff in io memory space</code> <code>dim io_buff as byte io</code>

sfr

Description	This memory specifier in combination with (<code>rx</code> , <code>io</code> , <code>data</code>) allows user to access special function registers. It also instructs compiler to maintain same identifier in Basic and assembly.
Example	<code>dim io_buff as byte io sfr</code> <code>' put io_buff in I/O memory space</code> <code>dim y as char rx sfr</code> <code>' puts y in Rx space</code> <code>dim temp as byte data sfr</code> and <code>dim temp as byte sfr</code> are equivalent, and <code>put temp</code> in Extended I/O Space.

register

Description	If no other memory specifier is used (<code>rx</code> , <code>io</code> , <code>sfr</code> , <code>code</code> or <code>data</code>), the <code>register</code> specifier places variable in Rx space, and instructs compiler to maintain same identifier in C and assembly.
Example	<code>dim y as char register</code>

Note: If none of the memory specifiers are used when declaring a variable, data specifier will be set as default by the compiler.

Related topics: AVR Memory Organization, Accessing individual bits, SFRs, Constants, Functions

CHAPTER

5

mikroBasic PRO for AVR Language Reference

The mikroBasic PRO for AVR Language Reference describes the syntax, semantics and implementation of the mikroBasic PRO for AVR language.

The aim of this reference guide is to provide a more understandable description of the mikroBasic PRO for AVR language to the user.

MIKROBASIC PRO FOR AVR LANGUAGE REFERENCE

Lexical Elements

- Whitespace
- Comments
- Tokens
 - Literals
 - Keywords
 - Identifiers
 - Punctuators

Program Organization

- Program Organization
- Scope and Visibility
- Modules

Variables

Constants

Labels

Symbols

Functions and Procedures

- Functions
- Procedures

Types

- Simple Types
- Arrays
- Strings
- Pointers
- Structures
- Types Conversions
 - Implicit Conversion
 - Explicit Conversion

Operators

- Introduction to Operators
- Operators Precedence and Associativity
- Arithmetic Operators
- Relational Operators
- Bitwise Operators
- Boolean Operators

Expressions

- Expressions

Statements

- Introduction to Statements
- Assignment Statements
- Conditional Statements

- If Statement
- Select Case Statement
- Iteration Statements (Loops)
 - For Statement
 - While Statement
 - Do Statement
- Jump Statements
 - Break and Continue Statements
 - Exit Statement
 - Goto Statement
 - Gosub Statement
- asm Statement
- Directives**
 - Compiler Directives
 - Linker Directives

LEXICAL ELEMENTS OVERVIEW

These topics provide a formal definition of the mikroBasic PRO for AVR lexical elements. They describe different categories of word-like units (tokens) recognized by the language.

In tokenizing phase of compilation, the source code file is parsed (that is, broken down) into tokens and whitespace. The tokens in mikroBasic PRO are derived from a series of operations performed on your programs by the compiler.

A mikroBasic PRO program starts as a sequence of ASCII characters representing the source code, created by keystrokes using a suitable text editor (such as the mikroBasic PRO Code Editor). The basic program unit in mikroBasic PRO is a file. This usually corresponds to a named file located in RAM or on disk, having the extension `.mbas`.

WHITESPACE

Whitespace is a collective name given to spaces (blanks), horizontal and vertical tabs, and comments. Whitespace serves to indicate where tokens start and end, but beyond this function, any surplus whitespace is discarded.

For example, the two sequences

```
dim tmp as byte
dim j as word
```

and

```
dim tmp as byte
dim j as word
```

are lexically equivalent and parse identically.

Newline Character

Newline character (CR/LF) is not a whitespace in BASIC, and serves as a statement terminator/separator. In mikroBasic PRO for AVR, however, you may use newline to break long statements into several lines. Parser will first try to get the longest possible expression (across lines if necessary), and then check for statement terminators.

Whitespace in Strings

The ASCII characters representing whitespace can occur within string literals, where they are protected from the normal parsing process (they remain as a part of the string). For example, statement

```
some_string = "mikro foo"
```

parses to four tokens, including a single string literal token:

```
some_string
=
"mikro foo"
newline character
```

COMMENTS

Comments are pieces of text used to annotate a program, and are technically another form of whitespace. Comments are for the programmer's use only; they are stripped from the source text before parsing.

Use the apostrophe to create a comment:

```
' Any text between an apostrophe and the end of the  
' line constitutes a comment. May span one line only.
```

There are no multi-line comments in mikroBasic PRO for AVR

TOKENS

Token is the smallest element of a mikroBasic PRO for AVR program, meaningful to the compiler. The parser separates tokens from the input stream by creating the longest token possible using the input characters in a left-to-right scan.

mikroBasic PRO for AVR recognizes the following kinds of tokens:

- keywords
- identifiers
- constants
- operators
- punctuators (also known as separators)

Token Extraction Example

Here is an example of token extraction. See the following code sequence:

```
end_flag = 0
```

The compiler would parse it into four tokens:

```
end_flag  ' variable identifier  
=         ' assignment operator  
0         ' literal  
newline   ' statement terminator
```

Note that `end_flag` would be parsed as a single identifier, rather than the keyword `end` followed by the identifier `_flag`.

LITERALS

Literals are tokens representing fixed numeric or character values.

The data type of a constant is deduced by the compiler using such clues as numeric value and format used in the source code.

Integer Literals

Integral values can be represented in decimal, hexadecimal or binary notation.

In decimal notation, numerals are represented as a sequence of digits (without commas, spaces or dots), with optional prefix + or - operator to indicate the sign. Values default to positive (`6258` is equivalent to `+6258`).

The dollar-sign prefix (\$) or the prefix `0x` indicates a hexadecimal numeral (for example, `$8F` or `0x8F`).

The percent-sign prefix (%) indicates a binary numeral (for example, `%0101`).

Here are some examples:

```
11      ' decimal literal
$11     ' hex literal, equals decimal 17
0x11   ' hex literal, equals decimal 17
%11    ' binary literal, equals decimal 3
```

The allowed range of values is imposed by the largest data type in mikroBasic PRO for AVR – `longword`. The compiler will report an error if the literal exceeds `4294967295` (`$FFFFFFFF`).

Floating Point Literals

A floating-point value consists of:

- Decimal integer
- Decimal point
- Decimal fraction
- e or E and a signed integer exponent (optional)

You can omit either decimal integer or decimal fraction (but not both).

Negative floating constants are taken as positive constants with the unary operator minus (-) prefixed.

mikroBasic PRO limits floating-point constants to the range of $\pm 1.17549435082 * 10^{-38} .. \pm 6.80564774407 * 10^{38}$.

Here are some examples:

```
0.           ' = 0.0
-1.23        ' = -1.23
23.45e6      ' = 23.45 * 10^6
2e-5         ' = 2.0 * 10^-5
3E+10        ' = 3.0 * 10^10
.09E34       ' = 0.09 * 10^34
```

Character Literals

Character literal is one character from the extended ASCII character set, enclosed with quotes (for example, "A"). Character literal can be assigned to variables of `byte` and `char` type (variable of `byte` will be assigned the ASCII value of the character). Also, you can assign character literal to a string variable.

String Literals

String literal is a sequence of characters from the extended ASCII character set, enclosed with quotes. Whitespace is preserved in string literals, i.e. parser does not "go into" strings but treats them as single tokens.

Length of string literal is a number of characters it consists of. String is stored internally as the given sequence of characters plus a final `null` character. This `null` character is introduced to terminate the string, it does not count against the string's total length.

String literal with nothing in between the quotes (null string) is stored as a single null character.

You can assign string literal to a string variable or to an array of char.

Here are several string literals:

```
"Hello world!"      ' message, 12 chars long
"Temperature is stable" ' message, 21 chars long
"  "                ' two spaces, 2 chars long
"C"                 ' letter, 1 char long
""                  ' null string, 0 chars long
```

The quote itself cannot be a part of the string literal, i.e. there is no escape sequence. You could use the built-in function `Chr` to print a quote: `Chr(34)`. Also, see String Splicing.

KEYWORDS

Keywords are special-purpose words which cannot be used as normal identifier names.

Beside standard BASIC keywords, all relevant SFR are defined as global variables and represent reserved words that cannot be redefined (for example: `P0`, `TMR1`, `T1CON`, etc). Probe Code Assistant for specific letters (Ctrl+Space in Editor) or refer to Predefined Globals and Constants.

Here is the alphabetical listing of keywords in mikroBasic PRO for AVR:

<code>Abstract</code>	<code>Far</code>	<code>Override</code>	<code>Then</code>
<code>And</code>	<code>File</code>	<code>package</code>	<code>Threadvar</code>
<code>Array</code>	<code>Finalization</code>	<code>Packed</code>	<code>To</code>
<code>As</code>	<code>Finally</code>	<code>Pascal</code>	<code>Try</code>
<code>at</code>	<code>For</code>	<code>pdata</code>	<code>Type</code>
<code>Asm</code>	<code>Forward</code>	<code>platform</code>	<code>Unit</code>
<code>Assembler</code>	<code>Function</code>	<code>Private</code>	<code>Until</code>
<code>Automated</code>	<code>Goto</code>	<code>Procedure</code>	<code>Uses</code>
<code>bdata</code>	<code>idata</code>	<code>Program</code>	<code>Var</code>
<code>Begin</code>	<code>If</code>	<code>Property</code>	<code>Virtual</code>
<code>bit</code>	<code>ilevel</code>	<code>Protected</code>	<code>Volatile</code>
<code>Case</code>	<code>Implementation</code>	<code>Public</code>	<code>While</code>
<code>Cdecl</code>	<code>In</code>	<code>Published</code>	<code>With</code>
<code>Class</code>	<code>Index</code>	<code>Raise</code>	<code>Write</code>
<code>Code</code>	<code>Inherited</code>	<code>Read</code>	<code>Writeonly</code>
<code>compact</code>	<code>Initialization</code>	<code>ReadOnly</code>	<code>xdata</code>
<code>Const</code>	<code>Inline</code>	<code>Record</code>	<code>Xor</code>
<code>Constructor</code>	<code>Interface</code>	<code>Register</code>	
<code>Contains</code>	<code>Is</code>	<code>Reintroduce</code>	
<code>Data</code>	<code>Label</code>	<code>Repeat</code>	
<code>Default</code>	<code>large</code>	<code>requires</code>	
<code>deprecated</code>	<code>Library</code>	<code>Reset</code>	
<code>Destructor</code>	<code>Message</code>	<code>Resourcestring</code>	
<code>DispId</code>	<code>Mod</code>	<code>Resume</code>	
<code>Dispinterface</code>	<code>name</code>	<code>Safecall</code>	
<code>Div</code>	<code>Near</code>	<code>sbit</code>	
<code>Do</code>	<code>Nil</code>	<code>Set</code>	
<code>Downto</code>	<code>Not</code>	<code>sfr</code>	
<code>Dynamic</code>	<code>Object</code>	<code>Shl</code>	
<code>Else</code>	<code>Of</code>	<code>Shr</code>	
<code>End</code>	<code>on</code>	<code>small</code>	
<code>Except</code>	<code>Or</code>	<code>Stdcall</code>	
<code>Export</code>	<code>org</code>	<code>Stored</code>	
<code>Exports</code>	<code>Out</code>	<code>String</code>	
<code>External</code>	<code>overload</code>	<code>Stringresource</code>	

Also, mikroBasic PRO for AVR includes a number of predefined identifiers used in libraries. You could replace them by your own definitions, if you plan to develop your own libraries. For more information, see mikroBasic PRO for AVR Libraries.

IDENTIFIERS

Identifiers are arbitrary names of any length given to functions, variables, symbolic constants, user-defined data types and labels. All these program elements will be referred to as objects throughout the help (don't be confused with the meaning of object in object-oriented programming).

Identifiers can contain letters from `a` to `z` and `A` to `Z`, the underscore character “`_`” and digits from `0` to `9`. First character must be a letter or an underscore, i.e. identifier cannot begin with a numeral.

Case Sensitivity

mikroBasic PRO for AVR is not case sensitive, so `Sum`, `sum`, and `suM` are equivalent identifiers.

Uniqueness and Scope

Although identifier names are arbitrary (within the rules stated), errors result if the same name is used for more than one identifier within the same scope. Simply, duplicate names are illegal within the same scope. For more information, refer to Scope and Visibility.

Identifier Examples

Here are some valid identifiers:

```
temperature_V1
Pressure
no_hit
dat2string
SUM3
_vtext
```

... and here are some invalid identifiers:

```
7temp           ' NO -- cannot begin with a numeral
%higher         ' NO -- cannot contain special characters
xor             ' NO -- cannot match reserved word
j23.07.04       ' NO -- cannot contain special characters (dot)
```

PUNCTUATORS

The mikroBasic PRO punctuators (also known as separators) are:

- [] – Brackets
- () – Parentheses
- , – Comma
- : – Colon
- . – Dot

Brackets

Brackets [] indicate single and multidimensional array subscripts:

```
dim alphabet as byte[ 30]
' ...
alphabet[ 2] = "c"
```

For more information, refer to Arrays.

Parentheses

Parentheses () are used to group expressions, isolate conditional expressions and indicate function calls and function declarations:

```
d = c * (a + b)           ' Override normal precedence
if (d = z) then ...      ' Useful with conditional statements
func()                   ' Function call, no arguments
sub function func2(dim n as word) ' Function declaration w/ parameters
```

For more information, refer to Operators Precedence and Associativity, Expressions, or Functions and Procedures.

Comma

Comma (,) separates the arguments in function calls:

```
Lcd_Out(1, 1, txt)
```

Furthermore, the comma separates identifiers in declarations:

```
dim i, j, k as word
```

The comma also separates elements in initialization lists of constant arrays:

```
const MONTHS as byte[ 12] = (31,28,31,30,31,30,31,31,30,31,30,31)
```

Colon

Colon (:) is used to indicate a labeled statement:

```
start:  nop
      '...'
goto start
```

For more information, refer to Labels.

Dot

Dot (.) indicates access to a structure member. For example:

```
person.surname = "Smith"
```

For more information, refer to Structures.

Dot is a necessary part of floating point literals. Also, dot can be used for accessing individual bits of registers in mikroBasic PRO.

PROGRAM ORGANIZATION

mikroBasic PRO for AVR imposes strict program organization. Below you can find models for writing legible and organized source files. For more information on file inclusion and scope, refer to Modules and to Scope and Visibility.

Organization of Main Module

Basically, a main source file has two sections: declaration and program body. Declarations should be in their proper place in the code, organized in an orderly manner. Otherwise, the compiler may not be able to comprehend the program correctly.

When writing code, follow the model presented below. The main module should look like this:

```
program <program name>
include <include other modules>

*****
'* Declarations (globals):
*****

' symbols declarations
symbol ...

' constants declarations
const ...

' structures declarations
structure ...

' variables declarations
dim Name[ , Name2...] as [ ^ ] type [ absolute 0x123] [ external]
[ volatile] [ register] [ sfr]

' procedures declarations
sub procedure_name(...)
  <local declarations>
  ...
end sub

' functions declarations
sub function_name(...) as return_type
  <local declarations>
  ...
end sub

*****
'* Program body:
*****

main:
  ' write your code here
end.
```

Organization of Other Modules

Modules other than main start with the keyword `module`. Implementation section starts with the keyword `implements`. Follow the model presented below:

```

module <module name>
include <include other modules>

*****
'* Interface (globals):
*****

' symbols declarations
symbol ...

' constants declarations
const ...

' structures declarations
structure ...

' variables declarations
dim Name[, Name2...] as [ ^ ] type [ absolute 0x123] [ external]
[ volatile] [ register] [ sfr]

' procedures prototypes
sub procedure sub_procedure_name([ dim byref] [ const] ParamName as
[ ^ ] type, [ dim byref] [ const] ParamName2, ParamName3 as [ ^ ] type)

' functions prototypes
sub function sub_function_name([ dim byref] [ const] ParamName as
[ ^ ] type, [ dim byref] [ const] ParamName2, ParamName3 as [ ^ ] type) as
[ ^ ] type

*****
'* Implementation:
*****

implements

' constants declarations
const ...

' variables declarations
dim ...

```

```
' procedures declarations
sub procedure sub_procedure_name([ dim byref] [ const] ParamName as
[ ^]type, [ dim byref] [ const] ParamName2, ParamName3 as [ ^]type);
[ ilevel 0x123] [ overload] [ forward]
    <local declarations>
    ...
end sub

' functions declarations
sub function sub_function_name([ dim byref] [ const] ParamName as
[ ^]type, [ dim byref] [ const] ParamName2, ParamName3 as [ ^]type) as
[ ^]type [ ilevel 0x123] [ overload] [ forward]
    <local declarations>
    ...
end sub

end.
```

Note: Sub functions and sub procedures must have the same declarations in the interface and implementation section. Otherwise, compiler will report an error.

SCOPE AND VISIBILITY

Scope

The scope of identifier is a part of the program in which the identifier can be used to access its object. There are different categories of scope, depending on how and where identifiers are declared:

Place of declaration	Scope
Identifier is declared in the declaration section of the main module, out of any function or procedure	Scope extends from the point where it is declared to the end of the current file, including all routines enclosed within that scope. These identifiers have a file scope and are referred to as globals.
Identifier is declared in the function or procedure	Scope extends from the point where it is declared to the end of the current routine. These identifiers are referred to as locals.
Identifier is declared in the interface section of the module	Scope extends the interface section of a module from the point where it is declared to the end of the module, and to any other module or program that uses that module. The only exception are symbols which have a scope limited to the file in which they are declared.
Identifier is declared in the implementation section of the module, but not within any function or procedure	Scope extends from the point where it is declared to the end of the module. The identifier is available to any function or procedure in the module.

Visibility

The visibility of an identifier is a region of the program source code from where a legal access to the identifier's associated object can be made .

Scope and visibility usually coincide, though there are circumstances under which an object becomes temporarily hidden by the appearance of a duplicate identifier: the object still exists but the original identifier cannot be used to access it until the scope of the duplicate identifier is ended.

Technically, visibility cannot exceed scope, but scope can exceed visibility.

MODULES

In mikroBasic PRO for AVR, each project consists of a single project file and one or more module files. The project file, with extension `.mbpav` contains information on the project, while modules, with extension `.mbas`, contain the actual source code. See Program Organization for a detailed look at module arrangement.

Modules allow you to:

- break large programs into encapsulated modules that can be edited separately,
- create libraries that can be used in different projects,
- distribute libraries to other developers without disclosing the source code.

Each module is stored in its own file and compiled separately; compiled modules are linked to create an application. To build a project, the compiler needs either a source file or a compiled module file for each module.

Include Clause

mikroBasic PRO for AVR includes modules by means of the include clause. It consists of the reserved word `include`, followed by a quoted module name. Extension of the file should not be included.

You can include one file per include clause. There can be any number of the include clauses in each source file, but they all must be stated immediately after the program (or module) name.

Here's an example:

```
program MyProgram  
  
include "utils"  
include "strings"  
include "MyUnit"  
  
...
```

For the given module name, the compiler will check for the presence of `.mcl` and `.mbas` files, in order specified by search paths.

- If both `.mbas` and `.mcl` files are found, the compiler will check their dates and include the newer one in the project. If the `.mbas` file is newer than the `.mcl`, then `.mbas` file will be recompiled and new `.mcl` will be created, overwriting the old `.mcl`.
- If only the `.mbas` file is found, the compiler will create the `.mcl` file and include it in the project;
- If only the `.mcl` file is present, i.e. no source code is available, the compiler will include it as found;
- If none of the files found, the compiler will issue a "File not found" warning.

Main Module

Every project in mikroBasic PRO for AVR requires a single main module file. The main module is identified by the keyword `program` at the beginning. It instructs the compiler where to “start”.

After you have successfully created an empty project with Project Wizard, Code Editor will display a new main module. It contains the bare-bones of the program:

```
program MyProject

' main procedure
main:
  ' Place program code here
end.
```

Other than comments, nothing should precede the keyword `program`. After the program name, you can optionally place the `include` clauses.

Place all global declarations (constants, variables, labels, routines, structures) before the label `main`.

Other Modules

Modules other than main start with the keyword `module`. Newly created blank module contains the bare-bones:

```
module MyModule

implements

end.
```

Other than comments, nothing should precede the keyword `module`. After the module name, you can optionally place the `include` clauses.

Interface Section

Part of the module above the keyword `implements` is referred to as interface section. Here, you can place global declarations (constants, variables, labels, routines, structures) for the project.

Do not define routines in the interface section. Instead, state the prototypes of routines (from implementation section) that you want to be visible outside the module. Prototypes must exactly match the declarations.

Implementation Section

Implementation section hides all the irrelevant innards from other modules, allowing encapsulation of code.

Everything declared below the keyword `implements` is private, i.e. has its scope limited to the file. When you declare an identifier in the implementation section of a module, you cannot use it outside the module, but you can use it in any block or routine defined within the module.

By placing the prototype in the interface section of the module (above the `implements`) you can make the routine public, i.e. visible outside of module. Prototypes must exactly match the declarations.

VARIABLES

Variable is an object whose value can be changed during the runtime. Every variable is declared under unique name which must be a valid identifier. This name is used for accessing the memory location occupied by the variable.

Variables are declared in the declaration part of the file or routine — each variable needs to be declared before it is used. Global variables (those that do not belong to any enclosing block) are declared below the `include` statements, above the label `main`.

Specifying a data type for each variable is mandatory. mikroBasic PRO syntax for variable declaration is:

```
dim identifier_list as type
```

Here, `identifier_list` is a comma-delimited list of valid identifiers, and `type` can be any data type.

For more details refer to Types and Types Conversions. For more information on variables' scope refer to the chapter Scope and Visibility.

Here are a few examples:

```
dim i, j, k as byte
dim counter, temp as word
dim samples as longint[100]
```

Variables and AVR

Every declared variable consumes part of RAM memory. Data type of variable determines not only the allowed range of values, but also the space a variable occupies in RAM memory. Bear in mind that operations using different types of variables take different time to be completed. mikroBasic PRO for AVR recycles local variable memory space – local variables declared in different functions and procedures share the same memory space, if possible.

There is no need to declare SFR explicitly, as mikroBasic PRO for AVR automatically declares relevant registers as global variables of `word`. For example: `W0`, `TMR1`, etc.

CONSTANTS

Constant is a data whose value cannot be changed during the runtime. Using a constant in a program consumes no RAM memory. Constants can be used in any expression, but cannot be assigned a new value.

Constants are declared in the declaration part of the program or routine, with the following syntax:

```
const constant_name [ as type] = value
```

Every constant is declared under unique `constant_name` which must be a valid identifier. It is a tradition to write constant names in uppercase. Constant requires you to specify `value`, which is a literal appropriate for the given type. `type` is optional and in the absence of it , the compiler assumes the “smallest” type that can accommodate value.

Note: You cannot omit type if declaring a constant array.

Here are a few examples:

```
const MAX as longint = 10000
const MIN = 1000      ' compiler will assume word type
const SWITCH = "n"   ' compiler will assume char type
const MSG = "Hello"  ' compiler will assume string type
const MONTHS as byte[ 12] = (31,28,31,30,31,30,31,31,30,31,30,31)
```

LABELS

Labels serve as targets for the `goto` and `gosub` statements. Mark the desired statement with label and colon like this:

```
label_identifier : statement
```

No special declaration of label is necessary in mikroBasic PRO for AVR.

Name of the label needs to be a valid identifier. The labeled statement and `goto/gosub` statement must belong to the same block. Hence it is not possible to jump into or out of routine. Do not mark more than one statement in a block with the same label.

Note: The label `main` marks the entry point of a program and must be present in the main module of every project. See Program Organization for more information.

Here is an example of an infinite loop that calls the procedure `Beep` repeatedly:

```
loop:  
    Beep  
goto loop
```

SYMBOLS

mikroBasic PRO symbols allow you to create simple macros without parameters. You can replace any line of code with a single identifier alias. Symbols, when properly used, can increase code legibility and reusability.

Symbols need to be declared at the very beginning of the module, right after the module name and (optional) `include` clauses. Check Program Organization for more details. Scope of a symbol is always limited to the file in which it has been declared.

Symbol is declared as:

```
symbol alias = code
```

Here, `alias` must be a valid identifier which you will use throughout the code. This identifier has a file scope. The `code` can be any line of code (literals, assignments, function calls, etc).

Using a symbol in the program consumes no RAM – the compiler will simply replace each instance of a symbol with the appropriate line of code from the declaration.

Here is an example:

```
symbol MAXALLOWED = 216           ' Symbol as alias for numeric value
symbol PORT = P0                   ' Symbol as alias for SFR
symbol MYDELAY = Delay_ms(1000)    ' Symbol as alias for procedure call

dim cnt as byte ' Some variable

'...
main:

if cnt > MAXALLOWED then
    cnt = 0
    PORT.1 = 0
    MYDELAY
end if
```

Note: Symbols do not support macro expansion in a way the C preprocessor does.

FUNCTIONS AND PROCEDURES

Functions and procedures, collectively referred to as routines, are subprograms (self-contained statement blocks) which perform a certain task based on a number of input parameters. When executed, a function returns value while procedure does not.

Functions

Function is declared like this:

```
sub function function_name(parameter_list) as return_type  
  [ local declarations ]  
  function body  
end sub
```

`function_name` represents a function's name and can be any valid identifier. `return_type` is a type of return value and can be any simple type. Within parentheses, `parameter_list` is a formal parameter list similar to variable declaration. In mikroBasic PRO for AVR, parameters are always passed to a function by value. To pass an argument by address, add the keyword `byref` ahead of identifier.

`Local declarations` are optional declarations of variables and/or constants, local for the given function. `Function body` is a sequence of statements to be executed upon calling the function.

Calling a function

A function is called by its name, with actual arguments placed in the same sequence as their matching formal parameters. The compiler is able to coerce mismatching arguments to the proper type according to implicit conversion rules. Upon a function call, all formal parameters are created as local objects initialized by values of actual arguments. Upon return from a function, a temporary object is created in the place of the call and it is initialized by the value of the function result. This means that function call as an operand in complex expression is treated as the function result.

In standard Basic, a `function_name` is automatically created local variable that can be used for returning a value of a function. mikroBasic PRO for AVR also allows you to use the automatically created local variable `result` to assign the return value of a function if you find function name to be too ponderous. If the return value of a function is not defined the compiler will report an error.

Function calls are considered to be primary expressions and can be used in situations where expression is expected. A function call can also be a self-contained statement and in that case the return value is discarded.

Example

Here's a simple function which calculates x^n based on input parameters x and n ($n > 0$):

```
sub function power(dim x, n as byte) as longint
dim i as byte
  result = 1
  if n > 0 then
    for i = 1 to n
      result = result*x
    next i
  end if
end sub
```

Now we could call it to calculate, say, 312:

```
tmp = power(3, 12)
```

PROCEDURES

Procedure is declared like this:

```
sub procedure procedure_name(parameter_list)
  [ local declarations ]
  procedure body
end sub
```

`procedure_name` represents a procedure's name and can be any valid identifier. Within parentheses, `parameter_list` is a formal parameter list similar to variable declaration. In mikroBasic PRO for AVR, parameters are always passed to procedure by value; to pass argument by address, add the keyword `byref` ahead of identifier.

`Local declarations` are optional declaration of variables and/or constants, local for the given procedure. `Procedure` body is a sequence of statements to be executed upon calling the procedure.

Calling a procedure

A procedure is called by its name, with actual arguments placed in the same sequence as their matching formal parameters. The compiler is able to coerce mismatching arguments to the proper type according to implicit conversion rules. Upon procedure call, all formal parameters are created as local objects initialized by values of actual arguments.

Procedure call is a self-contained statement.

Example

Here's an example procedure which transforms its input time parameters, preparing them for output on Lcd:

```
sub procedure time_prep(dim byref sec, min, hr as byte)
    sec = ((sec and $F0) >> 4)*10 + (sec and $0F)
    min = ((min and $F0) >> 4)*10 + (min and $0F)
    hr  = ((hr  and $F0) >> 4)*10 + (hr  and $0F)
end sub
```

Function Pointers

Function pointers are allowed in mikroBasic PRO for AVR. The example shows how to define and use a function pointer:

Example:

Example demonstrates the usage of function pointers. It is shown how to declare a procedural type, a pointer to function and finally how to call a function via pointer.

```
program Example;

typedef TMyFunctionType = function (dim param1, param2 as byte, dim
param3 as word) as word ' First, define the procedural type

dim MyPtr as ^TMyFunctionType ' This is a pointer to previously
defined type
dim sample as word

sub function Func1(dim p1, p2 as byte, dim p3 as word) as word ' Now,
define few functions which will be pointed to. Make sure that param-
eters match the type definition
    result = p1 and p2 or p3
end sub

sub function Func2(dim abc, def as byte, dim ghi as word) as word '
Another function of the same kind. Make sure that parameters match
the type definition
    result = abc * def + ghi
end sub

sub function Func3(dim first, yellow as byte, dim monday as word) as
word ' Yet another function. Make sure that parameters match the
type definition
    result = monday - yellow - first
end sub
```

Forward declaration

A function can be declared without having it followed by its implementation, by having it followed by the forward procedure. The effective implementation of that function must follow later in the module. The function can be used after a forward declaration as if it had been implemented already. The following is an example of a forward declaration:

```
program Volume

dim Volume as word

sub function First(a as word, b as word) as word forward

sub function Second(c as word) as word
dim tmp as word
  tmp = First(2, 3)
  result = tmp * c
end sub

sub function First(a, b as word) as word
  result = a * b
end sub

main:
  Volume = Second(4)
end.
```

TYPES

Basic is strictly typed language, which means that every variable and constant need to have a strictly defined type, known at the time of compilation.

The type serves:

- to determine correct memory allocation required,
- to interpret the bit patterns found in the object during subsequent accesses,
- in many type-checking situations, to ensure that illegal assignments are trapped.

mikroBasic PRO supports many standard (predefined) and user-defined data types, including signed and unsigned integers of various sizes, arrays, strings, pointers and structures.

Type Categories

Types can be divided into:

- simple types
- arrays
- strings
- pointers
- structures

SIMPLE TYPES

Simple types represent types that cannot be divided into more basic elements and are the model for representing elementary data on machine level. Basic memory unit in mikroBasic PRO for AVR has 8 bits.

Here is an overview of simple types in mikroBasic PRO for AVR:

Type	Size	Range
<code>byte</code> , <code>char</code>	8-bit	0 .. 255
<code>short</code>	8-bit	-127 .. 128
<code>word</code>	16-bit	0 .. 65535
<code>integer</code>	16-bit	-32768 .. 32767
<code>longword</code>	32-bit	0 .. 4294967295
<code>longint</code>	32-bit	-2147483648 .. 2147483647
<code>float</code>	32-bit	$\pm 1.17549435082 * 10^{-38}$.. $\pm 6.80564774407 * 10^{38}$
<code>bit</code>	1-bit	0 or 1
<code>sbit</code>	1-bit	0 or 1

You can assign signed to unsigned or vice versa only using the explicit conversion. Refer to Types Conversions for more information.

ARRAYS

An array represents an indexed collection of elements of the same type (called the base type). Since each element has a unique index, arrays, unlike sets, can meaningfully contain the same value more than once.

Array Declaration

Array types are denoted by constructions in the following form:

```
type[ array_length]
```

Each of elements of an array is numbered from 0 through `array_length - 1`. Every element of an array is of `type` and can be accessed by specifying array name followed by element's index within brackets.

Here are a few examples of array declaration:

```
dim weekdays as byte[ 7]
dim samples as word[ 50]

main:
  ' Now we can access elements of array variables, for example:
  samples[ 0] = 1
  if samples[ 37] = 0 then
    ...
```

Constant Arrays

Constant array is initialized by assigning it a comma-delimited sequence of values within parentheses. For example:

```
' Declare a constant array which holds number of days in each month:
const MONTHS as byte[ 12] = (31,28,31,30,31,30,31,31,30,31,30,31)
```

Note that indexing is zero based; in the previous example, number of days in January is `MONTHS[0]` and number of days in December is `MONTHS[11]`.

The number of assigned values must not exceed the specified length. Vice versa is possible, when the trailing “excess” elements will be assigned zeroes.

For more information on arrays of `char`, refer to Strings.

STRINGS

A string represents a sequence of characters equivalent to an array of `char`. It is declared like this:

```
string[ string_length]
```

The specifier `string_length` is a number of characters a string consists of. The string is stored internally as the given sequence of characters plus a final `null` character (zero). This appended “stamp” does not count against string’s total length.

A null string (“”) is stored as a single `null` character.

You can assign string literals or other strings to string variables. The string on the right side of an assignment operator has to be shorter than another one, or of equal length. For example:

```
dim msg1 as string[ 20]
dim msg2 as string[ 19]

main:
    msg1 = "This is some message"
    msg2 = "Yet another message"

    msg1 = msg2 ' this is ok, but vice versa would be illegal
```

Alternately, you can handle strings element–by–element. For example:

```
dim s as string[ 5]
' ...
s = "mik"
' s[ 0] is char literal "m"
' s[ 1] is char literal "i"
' s[ 2] is char literal "k"
' s[ 3] is zero
' s[ 4] is undefined
' s[ 5] is undefined
```

Be careful when handling strings in this way, since overwriting the end of a string will cause an unpredictable behavior.

Note

mikroBasic PRO for AVR includes String Library which automatizes string related tasks.

POINTERS

A pointer is a data type which holds a memory address. While a variable accesses that memory address directly, a pointer can be thought of as a reference to that memory address.

To declare a pointer data type, add a caret prefix (^) before type. For example, if you are creating a pointer to an `integer`, you would write:

```
^integer
```

To access the data at the pointer's memory location, you add a caret after the variable name. For example, let's declare variable `p` which points to `word`, and then assign the pointed memory location value 5:

```
dim p as ^word  
'...  
p^ = 5
```

A pointer can be assigned to another pointer. However, note that only address, not value, is copied. Once you modify the data located at one pointer, the other pointer, when dereferenced, also yields modified data.

@ Operator

The @ operator returns the address of a variable or routine, i.e. @ constructs a pointer to its operand. The following rules are applied to @:

- If `X` is a variable, @`X` returns the address of `X`.
- If `F` is a routine (a function or procedure), @`F` returns `F`'s entry point (the result is of `longint`).

STRUCTURES

A structure represents a heterogeneous set of elements. Each element is called a member; the declaration of a structure type specifies a name and type for each member. The syntax of a structure type declaration is

```
structure structname
  dim member1 as type1
  '...
  dim membern as typen
end structure
```

where `structname` is a valid identifier, each `type` denotes a type, and each `member` is a valid identifier. The scope of a member identifier is limited to the structure in which it occurs, so you don't have to worry about naming conflicts between member identifiers and other variables.

For example, the following declaration creates a structure type called `Dot`:

```
structure Dot
  dim x as float
  dim y as float
end structure
```

Each `Dot` contains two members: `x` and `y` coordinates; memory is allocated when you instantiate the structure, like this:

```
dim m, n as Dot
```

This variable declaration creates two instances of `Dot`, called `m` and `n`.

A member can be of the previously defined structure type. For example:

```
' Structure defining a circle:
structure Circle
  dim radius as float
  dim center as Dot
end structure
```

Structure Member Access

You can access the members of a structure by means of dot (.) as a direct member selector. If we had declared the variables `circle1` and `circle2` of the previously defined type `Circle`:

```
dim circle1, circle2 as Circle
```

we could access their individual members like this:

```
circle1.radius = 3.7  
circle1.center.x = 0  
circle1.center.y = 0
```

You can also commit assignments between complex variables, if they are of the same type:

```
circle2 = circle1 ' This will copy values of all members
```

TYPES CONVERSIONS

Conversion of variable of one type to variable of another type is typecasting. mikroBasic PRO for AVR supports both implicit and explicit conversions for built-in types.

Implicit Conversion

Compiler will provide an automatic implicit conversion in the following situations:

- statement requires an expression of particular type (according to language definition) and we use an expression of different type,
- operator requires an operand of particular type and we use an operand of different type,
- function requires a formal parameter of particular type and we pass it an object of different type,
- `result` does not match the declared function return type.

Promotion

When operands are of different types, implicit conversion promotes the less complex to the more complex type taking the following steps:

```
byte/char    → word
short        → integer
short        → longint
integer      → longint
integral     → float
```

Higher bytes of extended unsigned operand are filled with zeroes. Higher bytes of extended signed operand are filled with bit sign (if number is negative, fill higher bytes with one, otherwise with zeroes). For example:

```
dim a as byte
dim b as word
'...
a = $FF
b = a ' a is promoted to word, b becomes $00FF
```

Clipping

In assignments and statements that require an expression of particular type, destination will store the correct value only if it can properly represent the result of expression, i.e. if the result fits in destination range.

If expression evaluates to more complex type than expected excess data will be simply clipped (the higher bytes are lost).

```
dim i as byte
dim j as word
'...
j = $FF0F
i = j ' i becomes $0F, higher byte $FF is lost
```

EXPLICIT CONVERSION

Explicit conversion can be executed at any point by inserting type keyword (*byte*, *word*, *short*, *integer*, *longint*, or *float*) ahead of the expression to be converted. The expression must be enclosed in parentheses. Explicit conversion can be performed only on the operand left of the assignment operator.

Special case is the conversion between signed and unsigned types. Explicit conversion between signed and unsigned data does not change binary representation of data — it merely allows copying of source to destination.

For example:

```
dim a as byte
dim b as short
'...
b = -1
a = byte(b) ' a is 255, not 1

' This is because binary representation remains
' 11111111; it's just interpreted differently now
```

You cannot execute explicit conversion on the operand left of the assignment operator:

```
word(b) = a ' Compiler will report an error
```

OPERATORS

Operators are tokens that trigger some computation when being applied to variables and other objects in an expression.

There are four types of operators in mikroBasic PRO for AVR:

- Arithmetic Operators
- Bitwise Operators
- Boolean Operators
- Relational Operators

OPERATORS PRECEDENCE AND ASSOCIATIVITY

There are 4 precedence categories in mikroBasic PRO for AVR. Operators in the same category have equal precedence with each other.

Each category has an associativity rule: left-to-right (→), or right-to-left (←). In the absence of parentheses, these rules resolve the grouping of expressions with operators of equal precedence.

Precedence	Operands	Operators	Associativity
4	1	@ not + -	←
3	2	* / div mod and << >>	→
2	2	+ - or xor	→
1	2	= <> < > <= >=	→

ARITHMETIC OPERATORS

Arithmetic operators are used to perform mathematical computations. They have numerical operands and return numerical results. Since the `char` operators are technically `bytes`, they can be also used as unsigned operands in arithmetic operations.

All arithmetic operators associate from left to right.

Operator	Operation	Operands	Result
<code>+</code>	addition	<code>byte, short, word, integer, longint, longword, float</code>	<code>byte, short, word, integer, longint, longword, float</code>
<code>-</code>	subtraction	<code>byte, short, word, integer, longint, longword, float</code>	<code>byte, short, word, integer, longint, longword, float</code>
<code>*</code>	multiplication	<code>byte, short, word, integer, longint, longword, float</code>	<code>word, integer, longint, longword, float</code>
<code>/</code>	division, floating-point	<code>byte, short, word, integer, longint, longword, float</code>	<code>float</code>
<code>div</code>	division, rounds down to nearest integer	<code>byte, short, word, integer, longint, longword</code>	<code>byte, short, word, integer, longint, longword</code>
<code>mod</code>	modulus, returns the remainder of integer division (cannot be used with floating points)	<code>byte, short, word, integer, longint, longword</code>	<code>byte, short, word, integer, longint, longword</code>

Division by Zero

If 0 (zero) is used explicitly as the second operand (i.e. `x div 0`), the compiler will report an error and will not generate code.

But in case of implicit division by zero: `x div y`, where `y` is 0 (zero), the result will be the maximum integer (i.e. 255, if the result is `byte` type; 65536, if the result is `word` type, etc.).

Unary Arithmetic Operators

Operator `-` can be used as a prefix unary operator to change sign of a signed value. Unary prefix operator `+` can be used, but it doesn't affect data.

For example:

```
b = -a
```

RELATIONAL OPERATORS

Use relational operators to test equality or inequality of expressions. All relational operators return TRUE or FALSE.

Operator	Operation
=	equal
<>	not equal
>	greater than
<	less than
>=	greater than or equal
<=	less than or equal

All relational operators associate from left to right.

Relational Operators in Expressions

The equal sign (=) can also be an assignment operator, depending on context.

Precedence of arithmetic and relational operators was designated in such a way to allow complex expressions without parentheses to have expected meaning:

```
if aa + 5 >= bb - 1.0 / cc then      ' same as: if (aa + 5) >= (bb -
(1.0 / cc)) then
    dd = My_Function()
end if
```

BITWISE OPERATORS

Use the bitwise operators to modify the individual bits of numerical operands.

Bitwise operators associate from left to right. The only exception is the bitwise complement operator not which associates from right to left.

Bitwise Operators Overview

Operator	Operation
<code>and</code>	bitwise AND; compares pairs of bits and generates a 1 result if both bits are 1, otherwise it returns 0
<code>or</code>	bitwise (inclusive) OR; compares pairs of bits and generates a 1 result if either or both bits are 1, otherwise it returns 0
<code>xor</code>	bitwise exclusive OR (XOR); compares pairs of bits and generates a 1 result if the bits are complementary, otherwise it returns 0
<code>not</code>	bitwise complement (unary); inverts each bit
<code><<</code>	bitwise shift left; moves the bits to the left, it discards the far left bit and assigns 0 to the right most bit.
<code>>></code>	bitwise shift right; moves the bits to the right, discards the far right bit and if unsigned assigns 0 to the left most bit, otherwise sign extends

Logical Operations on Bit Level

and	0	1
0	0	0
1	0	1

or	0	1
0	0	1
1	1	1

xor	0	1
0	0	1
1	1	0

not	0	1
	1	0

The bitwise operators `and`, `or`, and `xor` perform logical operations on the appropriate pairs of bits of their operands. The operator `not` complements each bit of its operand. For example:

```

$1234 and $5678          ' equals $1230
'
' because ..
'
' $1234 : 0001 0010 0011 0100
' $5678 : 0101 0110 0111 1000
' -----
'   and : 0001 0010 0011 0000
'
' .. that is, $1230'

```

Similarly:

```

$1234 or  $5678          ' equals $567C
$1234 xor $5678          ' equals $444C
not $1234                ' equals $EDCB

```

Unsigned and Conversions

If number is converted from less complex to more complex data type, the upper bytes are filled with zeroes. If number is converted from more complex to less complex data type, the data is simply truncated (upper bytes are lost).

For example:

```

dim a as byte
dim b as word
' ...
' a = $AA
' b = $F0F0
' b = b and a
' a is extended with zeroes; b becomes $00A0

```

Signed and Conversions

If number is converted from less complex to more complex data type, the upper bytes are filled with ones if sign bit is 1 (number is negative); the upper bytes are filled with zeroes if sign bit is 0 (number is positive). If number is converted from more complex to less complex data type, the data is simply truncated (the upper bytes are lost).

For example:

```

dim a as byte
dim b as word
' ...
' a = -12
' b = $70FF
' b = b and a
'
' a is sign extended, upper byte is $FF;
' b becomes $70F4

```

Bitwise Shift Operators

The binary operators `<<` and `>>` move the bits of the left operand by a number of positions specified by the right operand, to the left or right, respectively. Right operand has to be positive and less than 255.

With shift left (`<<`), left most bits are discarded, and “new” bits on the right are assigned zeroes. Thus, shifting unsigned operand to the left by n positions is equivalent to multiplying it by 2^n if all discarded bits are zero. This is also true for signed operands if all discarded bits are equal to the sign bit.

With shift right (`>>`), right most bits are discarded, and the “freed” bits on the left are assigned zeroes (in case of unsigned operand) or the value of the sign bit (in case of signed operand). Shifting operand to the right by n positions is equivalent to dividing it by 2^n .

BOOLEAN OPERATORS

Although mikroBasic PRO for AVR does not support `boolean` type, you have Boolean operators at your disposal for building complex conditional expressions. These operators conform to standard Boolean logic and return either `TRUE` (all ones) or `FALSE` (zero):

Operator	Operation
<code>and</code>	logical AND
<code>or</code>	logical OR
<code>xor</code>	logical exclusive OR (XOR)
<code>not</code>	logical negation

Boolean operators associate from left to right. Negation operator `not` associates from right to left.

EXPRESSIONS

An expression is a sequence of operators, operands, and punctuators that returns a value.

The primary expressions include: literals, constants, variables and function calls. From them, using operators, more complex expressions can be created. Formally, expressions are defined recursively: subexpressions can be nested up to the limits of memory.

Expressions are evaluated according to certain conversion, grouping, associativity and precedence rules that depend on the operators used, presence of parentheses, and data types of the operands. The precedence and associativity of the operators are summarized in Operator Precedence and Associativity. The way operands and subexpressions are grouped does not necessarily specify the actual order in which they are evaluated by mikroBasic PRO for AVR.

STATEMENTS

Statements define algorithmic actions within a program. Each statement needs to be terminated with a semicolon (;). In the absence of specific jump and selection statements, statements are executed sequentially in the order of appearance in the source code.

The most simple statements are assignments, procedure calls and jump statements. These can be combined to form loops, branches and other structured statements.

Refer to:

- Assignment Statements
- Conditional Statements
- Iteration Statements (Loops)
- Jump Statements

- asm Statement

ASSIGNMENT STATEMENTS

Assignment statements have the following form:

```
variable = expression
```

The statement evaluates `expression` and assigns its value to `variable`. All rules of implicit conversion are applied. `Variable` can be any declared variable or array element, and `expression` can be any expression.

Do not confuse the assignment with relational operator = which tests for equality. mikroBasic PRO for AVR will interpret the meaning of the character = from the context.

CONDITIONAL STATEMENTS

Conditional or selection statements select from alternative courses of action by testing certain values. There are two types of selection statements:

- if
- select case

IF STATEMENT

Use the keyword `if` to implement a conditional statement. The syntax of the `if` statement has the following form:

```
if expression then
  statements
[ else
  other statements]
end if
```

When `expression` evaluates to true, `statements` execute. If `expression` is false, `other statements` execute. The `expression` must convert to a boolean type; otherwise, the condition is ill-formed. The `else` keyword with an alternate block of statements (`other statements`) is optional.

Nested if statements

Nested `if` statements require additional attention. A general rule is that the nested conditionals are parsed starting from the innermost conditional, with each `else` bound to the nearest available `if` on its left:

```
if expression1 then
  if expression2 then
    statement1
  else
    statement2
  end if
end if
```

The compiler treats the construction in this way:

```
if expression1 then
  if expression2 then
    statement1
  else
    statement2
  end if
end if
```

In order to force the compiler to interpret our example the other way around, we have to write it explicitly:

```
if expression1 then
  if expression2 then
    statement1
  end if
else
  statement2
end if
```

SELECT CASE STATEMENT

Use the `select case` statement to pass control to a specific program branch, based on a certain condition. The `select case` statement consists of selector expression (condition) and list of possible values. The syntax of the `select case` statement is:

```
select case selector
  case value_1
    statements_1
  ...
  case value_n
    statements_n
  [ case else
    default_statements]
end select
```

`selector` is an expression which should evaluate as integral value. `values` can be literals, constants or expressions and `statements` can be any statements. The `case else` clause is optional.

First, the `selector` expression (condition) is evaluated. The `select case` statement then compares it against all available `values`. If the match is found, the `statements` following the match evaluate, and the `select case` statement terminates. In case there are multiple matches, the first matching statement will be executed. If none of the `values` matches the selector, then `default_statements` in the `case else` clause (if there is one) are executed.

Here is a simple example of the select case statement:

```
select case operator
  case "*"
    res = n1 * n2
  case "/"
    res = n1 / n2
  case "+"
    res = n1 + n2
  case "-"
    res = n1 - n2
  case else
    res = 0
    cnt = cnt + 1
end select
```

Also, you can group values together for a match. Simply separate the items by commas:

```
select case reg
  case 0
    opmode = 0
  case 1,2,3,4
    opmode = 1
  case 5,6,7
    opmode = 2
end select
```

Nested Case Statements

Note that the `select case` statements can be nested – `values` are then assigned to the innermost enclosing `select case` statement.

ITERATION STATEMENTS

Iteration statements let you loop a set of statements. There are three forms of iteration statements in mikroBasic PRO for AVR:

- for
- while
- repeat

You can use the statements `break` and `continue` to control the flow of a loop statement. `break` terminates the statement in which it occurs, while `continue` begins executing the next iteration of the sequence.

FOR STATEMENT

The for statement implements an iterative loop and requires you to specify the number of iterations. The syntax of the for statement is:

```
for counter = initial_value to final_value [ step step_value]
    statements
next counter
```

`counter` is a variable being increased by `step_value` with each iteration of the loop. The parameter `step_value` is an optional integral value, and defaults to 1 if omitted. Before the first iteration, `counter` is set to `initial_value` and will be incremented until it reaches (or exceeds) the `final_value`. With each iteration, statements will be executed.

`initial_value` and `final_value` should be expressions compatible with `counter`; `statements` can be any statements that do not change the value of `counter`.

Note that the parameter `step_value` may be negative, allowing you to create a countdown.

Here is an example of calculating scalar product of two vectors, `a` and `b`, of length `n`, using the for statement:

```
s = 0
for i = 0 to n-1
    s = s + a[ i ] * b[ i ]
next i
```

Endless Loop

The for statement results in an endless loop if `final_value` equals or exceeds the range of the `counter`'s type.

WHILE STATEMENT

Use the `while` keyword to conditionally iterate a statement. The syntax of the `while` statement is:

```
while expression
  statements
wend
```

`statements` are executed repeatedly as long as `expression` evaluates true. The test takes place before `statements` are executed. Thus, if `expression` evaluates false on the first pass, the loop does not execute.

Here is an example of calculating scalar product of two vectors, using the `while` statement:

```
s = 0
i = 0
while i < n
  s = s + a[ i ] * b[ i ]
  i = i + 1
wend
```

Probably the easiest way to create an endless loop is to use the statement:

```
while TRUE
  ...
wend
```

DO STATEMENT

The `do` statement executes until the condition becomes true. The syntax of the `do` statement is:

```
do
    statements
loop until expression
```

`statements` are executed repeatedly until `expression` evaluates true. `expression` is evaluated after each iteration, so the loop will execute `statements` at least once.

Here is an example of calculating scalar product of two vectors, using the `do` statement:

```
s = 0
i = 0
do
    s = s + a[ i ] * b[ i ]
    i = i + 1
loop until i = n
```

JUMP STATEMENTS

A jump statement, when executed, transfers control unconditionally. There are five such statements in `mikroBasic PRO for AVR`:

- `break`
- `continue`
- `exit`
- `goto`
- `gosub`

BREAK AND CONTINUE STATEMENTS

Break Statement

Sometimes, you might need to stop the loop from within its body. Use the `break` statement within loops to pass control to the first statement following the innermost loop (`for`, `while`, or `do`).

For example:

```
Lcd_Out(1, 1, "No card inserted")

' Wait for CF card to be plugged; refresh every second
while true
  if Cf_Detect() = 1 then
    break
  end if
  Delay_ms(1000)
wend

' Now we can work with CF card ...
Lcd_Out(1, 1, "Card detected  ")
```

Continue Statement

You can use the `continue` statement within loops to “skip the cycle”:

- `continue` statement in the `for` loop moves program counter to the line with keyword `for`
- `continue` statement in the `while` loop moves program counter to the line with loop condition (top of the loop),
- `continue` statement in the `do` loop moves program counter to the line with loop condition (bottom of the loop).

<pre>' continue jumps here for i = continue ... next i</pre>	<pre>' continue jumps here while condition ... continue ... wend</pre>	<pre>do ... continue ... ' continue jumps here loop until condition</pre>
--	--	---

EXIT STATEMENT

The `exit` statement allows you to break out of a routine (function or procedure). It passes the control to the first statement following the routine call.

Here is a simple example:

```
sub procedure Proc1()  
dim error as byte  
... ' we're doing something here  
if error = TRUE then  
    exit  
end if  
... ' some code, which won't be executed if error is true  
end sub
```

Note: If breaking out of a function, return value will be the value of the local variable `result` at the moment of exit.

GOTO STATEMENT

Use the `goto` statement to unconditionally jump to a local label — for more information, refer to Labels. The syntax of the `goto` statement is:

```
goto label_name
```

This will transfer control to the location of a local label specified by `label_name`. The `goto` line can come before or after the label.

Label and `goto` statement must belong to the same block. Hence it is not possible to jump into or out of a procedure or function.

You can use `goto` to break out from any level of nested control structures. Never jump into a loop or other structured statement, since this can have unpredictable effects.

The use of `goto` statement is generally discouraged as practically every algorithm can be realized without it, resulting in legible structured programs. One possible application of the `goto` statement is breaking out from deeply nested control structures:

```
for i = 0 to n
  for j = 0 to m
    ...
    if disaster
      goto Error
    end if
    ...
  next j
next i
.
.
.
Error: ' error handling code
```

GOSUB STATEMENT

Use the `gosub` statement to unconditionally jump to a local label — for more information, refer to Labels. The syntax of the `gosub` statement is:

```
gosub label_name  
...  
label_name:  
...  
return
```

This will transfer control to the location of a local label specified by `label_name`. Also, the calling point is remembered. Upon encountering the `return` statement, program execution will continue with the next statement (line) after `gosub`. The `gosub` line can come before or after the label.

It is not possible to jump into or out of routine by means of `gosub`. Never jump into a loop or other structured statement, since this can have unpredictable effects.

Note: Like with `goto`, the use of `gosub` statement is generally discouraged. `mikroBasic PRO for AVR` supports `gosub` only for the sake of backward compatibility. It is better to rely on functions and procedures, creating legible structured programs.

ASM STATEMENT

mikroBasic PRO for AVR allows embedding assembly in the source code by means of the `asm` statement. Note that you cannot use numerals as absolute addresses for register variables in assembly instructions. You may use symbolic names instead (listing will display these names as well as addresses).

You can group assembly instructions with the `asm` keyword:

```
asm
    block of assembly instructions
end asm
```

mikroBasic PRO comments are not allowed in embedded assembly code. Instead, you may use one-line assembly comments starting with semicolon.

If you plan to use a certain mikroBasic PRO variable in embedded assembly only, be sure to at least initialize it (assign it initial value) in mikroBasic PRO code; otherwise, the linker will issue an error. This is not applied to predefined globals such as P0.

For example, the following code will not be compiled because the linker won't be able to recognize the variable `myvar`:

```
program test

dim myvar as word

main:
    asm
        MOV #10, W0
        MOV W0, _myvar
    end asm
end.
```

Adding the following line (or similar) above the `asm` block would let linker know that variable is used:

```
myvar = 20
```

DIRECTIVES

Directives are words of special significance which provide additional functionality regarding compilation and output.

The following directives are at your disposal:

- Compiler directives for conditional compilation,
- Linker directives for object distribution in memory.

COMPILER DIRECTIVES

Any line in source code with leading `#` is taken as a compiler directive. The initial `#` can be preceded or followed by whitespace (excluding new lines). The compiler directives are not case sensitive.

You can use conditional compilation to select particular sections of code to compile while excluding other sections. All compiler directives must be completed in the source file in which they begun.

Directives `#DEFINE` and `#UNDEFINE`

Use directive `#DEFINE` to define a conditional compiler constant (“flag”). You can use any identifier for a flag, with no limitations. No conflicts with program identifiers are possible because the flags have a separate name space. Only one flag can be set per directive.

For example:

```
#DEFINE extended_format
```

Use `#UNDEFINE` to undefine (“clear”) previously defined flag.

Directives `#IFDEF`, `#ELSEIF` and `#ELSE`

Conditional compilation is carried out by the `#IFDEF` directive. `#IFDEF` tests whether a flag is currently defined or not; i.e. whether the previous `#DEFINE` directive has been processed for that flag and is still in force.

The directive `#IFDEF` is terminated by the `#ENDIF` directive and can have any number of the `#ELSEIF` clauses and an optional `#ELSE` clause:

```

#ifdef flag THEN
    block of code
[ #ELSEIF flag_1 THEN
    block of code 1
...
#elseif flag_n THEN
    block of code n ]
[ #ELSE
    alternate block of code ]
#endif

```

First, `#ifdef` checks if flag is set by means of `#define`. If so, only block of code will be compiled. Otherwise, the compiler will check flags `flag_1 .. flag_n` and execute the appropriate block of code *i*. Eventually, if none of the flags is set, alternate block of code in `#else` (if any) will be compiled.

`#endif` ends the conditional sequence. The result of the preceding scenario is that only one section of code (possibly empty) is passed on for further processing. The processed section can contain further conditional clauses, nested to any depth; each `#ifdef` must be matched with a closing `#endif`.

Here is an example:

```

' Uncomment the appropriate flag for your application:
#define resolution8
#define resolution10
#define resolution12

#ifdef resolution8 THEN
    ... ' code specific to 8-bit resolution
#elseif resolution10 THEN
    ... ' code specific to 10-bit resolution
#elseif resolution12 THEN
    ... ' code specific to 12-bit resolution
#else
    ... ' default code
#endif

```

Predefined Flags

The compiler sets directives upon completion of project settings, so the user doesn't need to define certain flags.

Here is an example:

```

#ifdef ATMEGA16 ' If ATmega16 MCU is selected
#ifdef ATMEGA128 ' If ATmega128 MCU is selected

```

In some future releases of the compiler, the JTAG flag will be added also.

See also predefined project level defines.

LINKER DIRECTIVES

mikroBasic PRO for AVR uses internal algorithm to distribute objects within memory. If you need to have a variable or routine at the specific predefined address, use the linker directives `absolute` and `org`.

Note: You must specify an even address when using the linker directives.

Directive `absolute`

The directive `absolute` specifies the starting address in RAM for a variable. If the variable spans more than 1 word (16-bit), higher words will be stored at the consecutive locations.

The `absolute` directive is appended to the declaration of a variable:

```
dim x as word absolute 0x32
' Variable x will occupy 1 word (16 bits) at address 0x32

dim y as longint absolute 0x34
' Variable y will occupy 2 words at addresses 0x34 and 0x36
```

Be careful when using `absolute` directive, as you may overlap two variables by accident. For example:

```
dim i as word absolute 0x42
' Variable i will occupy 1 word at address 0x42;

dim jj as longint absolute 0x40
' Variable will occupy 2 words at 0x40 and 0x42; thus,
' changing i changes jj at the same time and vice versa
```

Note: You must specify an even address when using the directive `absolute`.

Directive `org`

The directive `org` specifies the starting address of a routine in ROM. It is appended to the declaration of routine. For example:

```
sub procedure proc(dim par as word) org 0x200
' Procedure will start at the address 0x200;
...
end sub
```

Note: You must specify an even address when using the directive `org`.

CHAPTER



mikroBasic PRO for AVR Libraries

mikroBasic PRO for AVR provides a set of libraries which simplify the initialization and use of AVR compliant MCUs and their modules:

Use Library manager to include mikroBasic PRO for AVR Libraries in you project.

HARDWARE AVR-SPECIFIC LIBRARIES

- ADC Library
- CANSPI Library
- Compact Flash Library
- EEPROM Library
- Flash Memory Library
- Graphic Lcd Library
- Keypad Library
- Lcd Library
- Manchester Code Library
- Multi Media Card library
- OneWire Library
- Port Expander Library
- PS/2 Library
- PWM Library
- PWM 16 bit Library
- RS-485 Library
- Software I2C Library
- Software SPI Library
- Software UART Library
- Sound Library
- SPI Library
- SPI Ethernet Library
- SPI Graphic Lcd Library
- SPI Lcd Library
- SPI Lcd8 Library
- SPI T6963C Graphic Lcd Library
- T6963C Graphic Lcd Library
- TWI Library
- UART Library

Miscellaneous Libraries

- Button Library
- Conversions Library
- Math Library
- String Library
- Time Library
- Trigonometry Library

See also Built-in Routines.

LIBRARY DEPENDENCIES

Certain libraries use (depend on) function and/or variables, constants defined in other libraries.

Image below shows clear representation about these dependencies.

For example, SPI_Glcd uses Glcd_Fonts and Port_Expander library which uses SPI library. This means that if you check SPI_Glcd library in Library manager, all libraries on which it depends will be checked too.

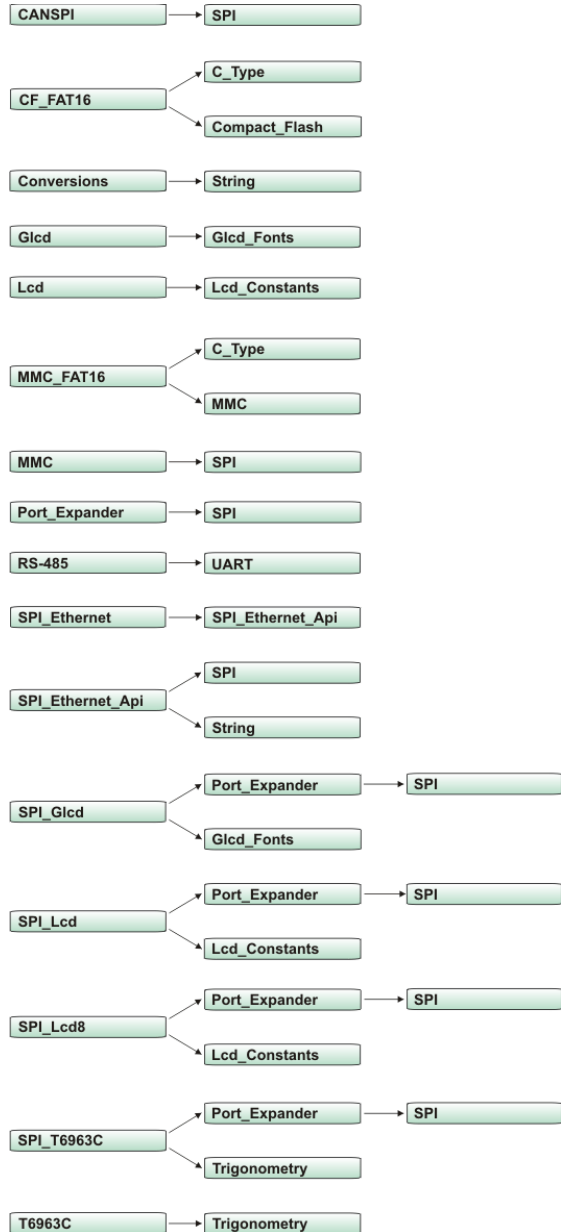

Related topics: Library manager,
AVR Libraries

ADC LIBRARY

ADC (Analog to Digital Converter) module is available with a number of AVR micros. Library function `ADC_Read` is included to provide you comfortable work with the module in single-ended mode.

ADC_Read

Prototype	<code>sub function ADC_Read(dim channel as byte) as word</code>
Returns	10-bit or 12-bit (MCU dependent) unsigned value from the specified <code>channel</code> .
Description	Initializes AVR 's internal ADC module to work with XTAL frequency prescaled by 128. Clock determines the time period necessary for performing A/D conversion. Parameter <code>channel</code> represents the channel from which the analog value is to be acquired. Refer to the appropriate datasheet for channel-to-pin mapping.
Requires	Nothing.
Example	<pre>dim tmp as word ... tmp = ADC_Read(2) ' Read analog value from channel 2</pre>

Library Example

This example code reads analog value from channel 2 and displays it on PORTB and PORTC.

```
program ADC_on_LEDs

dim adc_rd as word

main:
  DDRB = 0xFF          ' Set PORTB as output
  DDRC = 0xFF          ' Set PORTC as output

  while TRUE
    temp_res = ADC_Read(2) ' get ADC value from 2nd channel
    PORTB = adc_rd         ' display adc_rd[ 7..0]
    PORTC = Hi(adc_rd)    ' display adc_rd[ 9..8]
  wend
end.
```

HW Connection

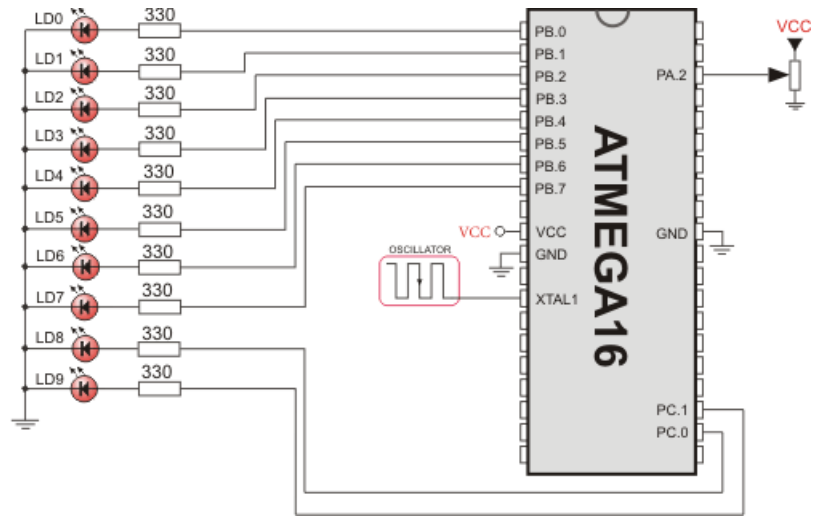

ADC HW connection

CANSPI LIBRARY

The SPI module is available with a number of the AVR compliant MCUs. The mikroBasic PRO for AVR provides a library (driver) for working with mikroElektronika's CANSPI Add-on boards (with MCP2515 or MCP2510) via SPI interface.

The CAN is a very robust protocol that has error detection and signalization, self-checking and fault confinement. Faulty CAN data and remote frames are re-transmitted automatically, similar to the Ethernet.

Data transfer rates depend on distance. For example, 1 Mbit/s can be achieved at network lengths below 40m while 250 Kbit/s can be achieved at network lengths below 250m. The greater distance the lower maximum bitrate that can be achieved. The lowest bitrate defined by the standard is 200Kbit/s. Cables used are shielded twisted pairs.

CAN supports two message formats:

- Standard format, with 11 identifier bits and
- Extended format, with 29 identifier bits

Note:

- Consult the CAN standard about CAN bus termination resistance.
- An effective CANSPI communication speed depends on SPI and certainly is slower than "real" CAN.
- CANSPI module refers to mikroElektronika's CANSPI Add-on board connected to SPI module of MCU.
- Prior to calling any of this library routines, Spi_Rd_Ptr needs to be initialized with the appropriate SPI_Read routine.

External dependencies of CANSPI Library

The following variables must be defined in all projects using CANSPI Library:	Description:	Example :
<code>dim CanSpi_CS as sbit sfr external</code>	Chip Select line.	<code>dim CanSpi_CS as sbit at PORTB.B0</code>
<code>dim CanSpi_Rst as sbit sfr external</code>	Reset line.	<code>dim CanSpi_Rst as sbit at PORTB.B2</code>
<code>dim CanSpi_CS_Bit_Directi on as sbit sfr external</code>	Direction of the Chip Select pin.	<code>dim CanSpi_CS_Bit_Directi on as sbit at DDRB.B0</code>
<code>dim CanSpi_Rst_Bit_Direct ion as sbit sfr external</code>	Direction of the Reset pin.	<code>dim CanSpi_Rst_Bit_Direct ion as sbit at DDRB.B2</code>

Library Routines

- CANSPISetOperationMode
- CANSPIGetOperationMode
- CANSPIInitialize
- CANSPISetBaudRate
- CANSPISetMask
- CANSPISetFilter
- CANSPIread
- CANSPIwrite

The following routines are for an internal use by the library only:

- RegsToCANSPIID
- CANSPIIDToRegs

Be sure to check CANSPI constants necessary for using some of the sub functions.

CANSPISetOperationMode

Prototype	<code>sub procedure CANSPISetOperationMode(dim mode as byte, dim WAIT as byte)</code>
Returns	Nothing.
Description	<p>Sets the CANSPI module to requested mode.</p> <p>Parameters :</p> <ul style="list-style-type: none"> - <code>mode</code>: CANSPI module operation mode. Valid values: <code>CANSPI_OP_MODE</code> constants (see CANSPI constants). - <code>WAIT</code>: CANSPI mode switching verification request. If <code>WAIT = 0</code>, the call is non-blocking. The sub function does not verify if the CANSPI module is switched to requested mode or not. Caller must use <code>CANSPIGetOperationMode</code> to verify correct operation mode before performing mode specific operation. If <code>WAIT != 0</code>, the call is blocking – the sub function won't "return" until the requested mode is set.
Requires	<p>The CANSPI routines are supported only by MCUs with the SPI module.</p> <p>MCU has to be properly connected to mikroElektronika's CANSPI Extra Board or similar hardware. See connection example at the bottom of this page.</p>
Example	<pre>' set the CANSPI module into configuration mode (wait inside CANSPISetOperationMode until this mode is set) CANSPISetOperationMode(CANSPI_MODE_CONFIG, 0xFF)</pre>

CANSPIGetOperationMode

Prototype	<code>sub function CANSPIGetOperationMode() as byte</code>
Returns	Current operation mode.
Description	<p>The sub function returns current operation mode of the CANSPI module. Check <code>CANSPI_OP_MODE</code> constants (see CANSPI constants) or device datasheet for operation mode codes.</p>
Requires	<p>The CANSPI routines are supported only by MCUs with the SPI module.</p> <p>MCU has to be properly connected to mikroElektronika's CANSPI Extra Board or similar hardware. See connection example at the bottom of this page.</p>
Example	<pre>' check whether the CANSPI module is in Normal mode and if it is do something. if (CANSPIGetOperationMode() = CANSPI_MODE_NORMAL) then ... end if</pre>

CANSPIInitialize

Prototype	<code>sub procedure CANSPIInitialize(dim SJW as byte, dim BRP as byte, dim PHSEG1 as byte, dim PHSEG2 as byte, dim PROPSEG as byte, dim CAN_CONFIG_FLAGS as byte)</code>
Returns	Nothing.
Description	<p>Initializes the CANSPI module.</p> <p>Stand-Alone CAN controller in the CANSPI module is set to:</p> <ul style="list-style-type: none"> - Disable CAN capture - Continue CAN operation in Idle mode - Do not abort pending transmissions - Fcan clock: 4*Tcy (Fosc) - Baud rate is set according to given parameters - CAN mode: Normal - Filter and mask registers IDs are set to zero - Filter and mask message frame type is set according to <code>CAN_CONFIG_FLAGS</code> value <p><code>SAM</code>, <code>SEG2PHTS</code>, <code>WAKFIL</code> and <code>DBEN</code> bits are set according to <code>CAN_CONFIG_FLAGS</code> value.</p> <p>Parameters:</p> <ul style="list-style-type: none"> - <code>SJW</code> as defined in CAN controller's datasheet - <code>BRP</code> as defined in CAN controller's datasheet - <code>PHSEG1</code> as defined in CAN controller's datasheet - <code>PHSEG2</code> as defined in CAN controller's datasheet - <code>PROPSEG</code> as defined in CAN controller's datasheet - <code>CAN_CONFIG_FLAGS</code> is formed from predefined constants (see CANSPI constants)
Requires	<p>Global variables :</p> <ul style="list-style-type: none"> - <code>CanSpi_CS</code>: Chip Select line - <code>CanSpi_Rst</code>: Reset line - <code>CanSpi_CS_Bit_Direction</code>: Direction of the Chip Select pin - <code>CanSpi_Rst_Bit_Direction</code>: Direction of the Reset pin <p>must be defined before using this function.</p> <p>The CANSPI routines are supported only by MCUs with the SPI module.</p> <p>The SPI module needs to be initialized. See the <code>SPI1_Init</code> and <code>SPI1_Init_Advanced</code> routines.</p> <p>MCU has to be properly connected to mikroElektronika's CANSPI Extra Board or similar hardware. See connection example at the bottom of this page.</p>

Example

```
' CANSPI module connections
dim CanSpi_CS      as sbit at  PORTB.B0
  CanSpi_CS_Direction  as sbit at  DDRB.B0
  CanSpi_Rst      as sbit at  PORTB.B2
  CanSpi_Rst_Direction  as sbit at  DDRB.B2
' End CANSPI module connections

...

dim Can_Init_Flags as byte
  ...
  Can_Init_Flags = CAN_CONFIG_SAMPLE_THRICE and ' form value to
be used
                                CAN_CONFIG_PHSEG2_PRG_ON and ' with
CANSPIInitialize
                                CAN_CONFIG_XTD_MSG           and
                                CAN_CONFIG_DBL_BUFFER_ON     and
                                CAN_CONFIG_VALID_XTD_MSG
  ...
  Spi_Rd_Ptr = @SPI1_Read      ' Pass pointer to SPI Read func-
tion of used SPI module
  SPI1_Init()                  ' initialize
SPI module
  CANSPIInitialize(1,3,3,3,1,Can_Init_Flags) ' initialize exter-
nal CANSPI module
```

CANSPISetBaudRate

Prototype	<code>sub procedure CANSPISetBaudRate(dim SJW as byte, dim BRP as byte, dim PHSEG1 as byte, dim PHSEG2 as byte, dim PROPSEG as byte, dim CAN_CONFIG_FLAGS as byte)</code>
Returns	Nothing.
Description	<p>Sets the CANSPI module baud rate. Due to complexity of the CAN protocol, you can not simply force a bps value. Instead, use this sub function when the CANSPI module is in Config mode.</p> <p><code>SAM</code>, <code>SEG2PHTS</code> and <code>WAKFIL</code> bits are set according to <code>CAN_CONFIG_FLAGS</code> value. Refer to datasheet for details.</p> <p>Parameters:</p> <ul style="list-style-type: none"> - <code>SJW</code> as defined in CAN controller's datasheet - <code>BRP</code> as defined in CAN controller's datasheet - <code>PHSEG1</code> as defined in CAN controller's datasheet - <code>PHSEG2</code> as defined in CAN controller's datasheet - <code>PROPSEG</code> as defined in CAN controller's datasheet - <code>CAN_CONFIG_FLAGS</code> is formed from predefined constants (see CANSPI constants)
Requires	<p>The CANSPI module must be in Config mode, otherwise the sub function will be ignored. See <code>CANSPISetOperationMode</code>.</p> <p>The CANSPI routines are supported only by MCUs with the SPI module.</p> <p>MCU has to be properly connected to mikroElektronika's CANSPI Extra Board or similar hardware. See connection example at the bottom of this page.</p>
Example	<pre>' set required baud rate and sampling rules dim can_config_flags as byte ... CANSPISetOperationMode(CANSPI_MODE_CONFIG, 0xFF) set CONFIGURATION mode (CANSPI module must be in config mode for baud rate settings) can_config_flags = CANSPI_CONFIG_SAMPLE_THRICE and CANSPI_CONFIG_PHSEG2_PRG_ON and CANSPI_CONFIG_STD_MSG and CANSPI_CONFIG_DBL_BUFFER_ON and CANSPI_CONFIG_VALID_XTD_MSG and CANSPI_CONFIG_LINE_FILTER_OFF CANSPISetBaudRate(1, 1, 3, 3, 1, can_config_flags)</pre>

CANSPISetMask

Prototype	<code>sub procedure CANSPISetMask(dim CAN_MASK as byte, dim val as longint, dim CAN_CONFIG_FLAGS as byte)</code>
Returns	Nothing.
Description	<p>Configures mask for advanced filtering of messages. The parameter value is bit-adjusted to the appropriate mask registers.</p> <p>Parameters:</p> <ul style="list-style-type: none"> - <code>CAN_MASK</code>: CANSPI module mask number. Valid values: <code>CANSPI_MASK</code> constants (see CANSPI constants) - <code>val</code>: mask register value - <code>CAN_CONFIG_FLAGS</code>: selects type of message to filter. Valid values: <ul style="list-style-type: none"> <code>CANSPI_CONFIG_ALL_VALID_MSG,</code> <code>CANSPI_CONFIG_MATCH_MSG_TYPE</code> and <code>CANSPI_CONFIG_STD_MSG,</code> <code>CANSPI_CONFIG_MATCH_MSG_TYPE</code> and <code>CANSPI_CONFIG_XTD_MSG.</code> <p>(see CANSPI constants)</p>
Requires	<p>The CANSPI module must be in Config mode, otherwise the sub function will be ignored. See <code>CANSPISetOperationMode</code>.</p> <p>The CANSPI routines are supported only by MCUs with the SPI module.</p> <p>MCU has to be properly connected to mikroElektronika's CANSPI Extra Board or similar hardware. See connection example at the bottom of this page.</p>
Example	<pre>' set the appropriate filter mask and message type value CANSPISetOperationMode(CANSPI_MODE_CONFIG,0xFF) ' set CONFIGURATION mode (CANSPI module must be in config mode for mask settings) ' Set all B1 mask bits to 1 (all filtered bits are relevant): ' Note that -1 is just a cheaper way to write 0xFFFFFFFF. ' Complement will do the trick and fill it up with ones. CANSPISetMask(CANSPI_MASK_B1, -1, CANSPI_CONFIG_MATCH_MSG_TYPE and CANSPI_CONFIG_XTD_MSG)</pre>

CANSPISetFilter

Prototype	<code>sub procedure CANSPISetFilter(dim CAN_FILTER as byte, dim val as longint, dim CAN_CONFIG_FLAGS as byte)</code>
Returns	Nothing.
Description	<p>Configures message filter. The parameter <code>value</code> is bit-adjusted to the appropriate filter registers.</p> <p>Parameters:</p> <ul style="list-style-type: none"> - <code>CAN_FILTER</code>: CANSPI module filter number. Valid values: <code>CANSPI_FILTER</code> constants (see CANSPI constants) - <code>val</code>: filter register value - <code>CAN_CONFIG_FLAGS</code>: selects type of message to filter. Valid values: <ul style="list-style-type: none"> <code>CANSPI_CONFIG_ALL_VALID_MSG,</code> <code>CANSPI_CONFIG_MATCH_MSG_TYPE</code> and <code>CANSPI_CONFIG_STD_MSG,</code> <code>CANSPI_CONFIG_MATCH_MSG_TYPE</code> and <code>CANSPI_CONFIG_XTD_MSG.</code> <p>(see CANSPI constants)</p>
Requires	<p>The CANSPI module must be in Config mode, otherwise the sub function will be ignored. See <code>CANSPISetOperationMode</code>.</p> <p>The CANSPI routines are supported only by MCUs with the SPI module.</p> <p>MCU has to be properly connected to mikroElektronika's CANSPI Extra Board or similar hardware. See connection example at the bottom of this page.</p>
Example	<pre>' set the appropriate filter value and message type CANSPISetOperationMode(CANSPI_MODE_CONFIG,0xFF) ' set CONFIGURATION mode (CANSPI module must be in config mode for filter settings) ' Set id of filter B1_F1 to 3: CANSPISetFilter(CANSPI_FILTER_B1_F1, 3, CANSPI_CONFIG_XTD_MSG)</pre>

CANSPIRead

Prototype	<code>sub function CANSPIRead(dim byref id as longint, dim byref rd_data as byte[8], dim data_len as byte, dim CAN_RX_MSG_FLAGS as byte) as byte</code>
Returns	<ul style="list-style-type: none"> - 0 if nothing is received - 0xFF if one of the Receive Buffers is full (message received)
Description	<p>If at least one full Receive Buffer is found, it will be processed in the following way:</p> <ul style="list-style-type: none"> - Message ID is retrieved and stored to location provided by the <code>id</code> parameter - Message data is retrieved and stored to a buffer provided by the <code>rd_data</code> parameter - Message length is retrieved and stored to location provided by the <code>data_len</code> parameter - Message flags are retrieved and stored to location provided by the <code>CAN_RX_MSG_FLAGS</code> parameter <p>Parameters:</p> <ul style="list-style-type: none"> - <code>id</code>: message identifier storage address - <code>rd_data</code>: data buffer (an array of bytes up to 8 bytes in length) - <code>data_len</code>: data length storage address. - <code>CAN_RX_MSG_FLAGS</code>: message flags storage address
Requires	<p>The CANSPI module must be in a mode in which receiving is possible. See <code>CANSPISetOperationMode</code>.</p> <p>The CANSPI routines are supported only by MCUs with the SPI module.</p> <p>MCU has to be properly connected to mikroElektronika's CANSPI Extra Board or similar hardware. See connection example at the bottom of this page.</p>
Example	<pre>' check the CANSPI module for received messages. If any was received do something. dim msg_rcvd, rx_flags, data_len as byte rd_data as byte[8] msg_id as longint ... CANSPISetOperationMode(CANSPI_MODE_NORMAL,0xFF) ' set NORMAL mode (CANSPI module must be in mode in which receive is possible) ... rx_flags = 0 clear message flags if (msg_rcvd = CANSPIRead(msg_id, rd_data, data_len, rx_flags) ... end if</pre>

CANSPIWrite

Prototype	<code>sub function CANSPIWrite(dim id as longint, dim byref wr_data as byte[8], dim data_len as byte, dim CAN_TX_MSG_FLAGS as byte) as byte</code>
Returns	<ul style="list-style-type: none"> - 0 if all Transmit Buffers are busy - 0xFF if at least one Transmit Buffer is available
Description	<p>If at least one empty Transmit Buffer is found, the sub function sends message in the queue for transmission.</p> <p>Parameters:</p> <ul style="list-style-type: none"> - <code>id</code>: CAN message identifier. Valid values: 11 or 29 bit values, depending on message type (standard or extended) - <code>wr_data</code>: data to be sent (an array of bytes up to 8 bytes in length) - <code>data_len</code>: data length. Valid values: 1 to 8 - <code>CAN_RX_MSG_FLAGS</code>: message flags
Requires	<p>The CANSPI module must be in mode in which transmission is possible. See CANSPISetOperationMode.</p> <p>The CANSPI routines are supported only by MCUs with the SPI module.</p> <p>MCU has to be properly connected to mikroElektronika's CANSPI Extra Board or similar hardware. See connection example at the bottom of this page.</p>
Example	<pre>' send message extended CAN message with the appropriate ID and data dim tx_flags as byte rd_data as byte[8] msg_id as longint ... CANSPISetOperationMode(CAN_MODE_NORMAL, 0xFF) set NORMAL mode (CANSPI must be in mode in which transmission is possible) tx_flags = CANSPI_TX_PRIORITY_0 and CANSPI_TX_XTD_FRAME ' set message flags CANSPIWrite(msg_id, rd_data, 2, tx_flags)</pre>

CANSPI Constants

There is a number of constants predefined in the CANSPI library. You need to be familiar with them in order to be able to use the library effectively. Check the example at the end of the chapter.

CANSPI_OP_MODE

The CANSPI_OP_MODE constants define CANSPI operation mode. Function CANSPISetOperationMode expects one of these as its argument:

```
const
    CANSPI_MODE_BITS           as byte = $E0 Use this to access opmode bits
    CANSPI_MODE_NORMAL        as byte = 0
    CANSPI_MODE_SLEEP         as byte = $20
    CANSPI_MODE_LOOP          as byte = $40
    CANSPI_MODE_LISTEN        as byte = $60
    CANSPI_MODE_CONFIG        as byte = $80
```

CANSPI_CONFIG_FLAGS

The CANSPI_CONFIG_FLAGS constants define flags related to the CANSPI module configuration. The functions CANSPIInitialize, CANSPISetBaudRate, CANSPISetMask and CANSPISetFilter expect one of these (or a bitwise combination) as their argument:

```
const
    CANSPI_CONFIG_DEFAULT           as byte = $FF ' 11111111

    CANSPI_CONFIG_PHSEG2_PRG_BIT    as byte = $01
    CANSPI_CONFIG_PHSEG2_PRG_ON    as byte = $FF ' XXXXXXX1
    CANSPI_CONFIG_PHSEG2_PRG_OFF   as byte = $FE ' XXXXXXX0

    CANSPI_CONFIG_LINE_FILTER_BIT   as byte = $02
    CANSPI_CONFIG_LINE_FILTER_ON   as byte = $FF ' XXXXXX1X
    CANSPI_CONFIG_LINE_FILTER_OFF  as byte = $FD ' XXXXXX0X

    CANSPI_CONFIG_SAMPLE_BIT        as byte = $04
    CANSPI_CONFIG_SAMPLE_ONCE       as byte = $FF ' XXXXX1XX
    CANSPI_CONFIG_SAMPLE_THRICE     as byte = $FB ' XXXXX0XX

    CANSPI_CONFIG_MSG_TYPE_BIT      as byte = $08
    CANSPI_CONFIG_STD_MSG           as byte = $FF ' XXXX1XXX
    CANSPI_CONFIG_XTD_MSG           as byte = $F7 ' XXXX0XXX
```



```

CANSPI_CONFIG_DBL_BUFFER_BIT      as byte = $10
CANSPI_CONFIG_DBL_BUFFER_ON       as byte = $FF   ' XXX1XXXX
CANSPI_CONFIG_DBL_BUFFER_OFF      as byte = $EF   ' XXX0XXXX

CANSPI_CONFIG_MSG_BITS            as byte = $60
CANSPI_CONFIG_ALL_MSG             as byte = $FF   ' X11XXXXX
CANSPI_CONFIG_VALID_XTD_MSG       as byte = $DF   ' X10XXXXX
CANSPI_CONFIG_VALID_STD_MSG       as byte = $BF   ' X01XXXXX
CANSPI_CONFIG_ALL_VALID_MSG       as byte = $9F   ' X00XXXXX

```

You may use bitwise and to form config byte out of these values. For example:

```

init = CANSPI_CONFIG_SAMPLE_THRICE and
       CANSPI_CONFIG_PHSEG2_PRG_ON  and
       CANSPI_CONFIG_STD_MSG        and
       CANSPI_CONFIG_DBL_BUFFER_ON  and
       CANSPI_CONFIG_VALID_XTD_MSG  and
       CANSPI_CONFIG_LINE_FILTER_OFF

...
CANSPIInit(1, 1, 3, 3, 1, init)    ' initialize CANSPI

```

CANSPI_TX_MSG_FLAGS

CANSPI_TX_MSG_FLAGS are flags related to transmission of a CAN message:

```

const
CANSPI_TX_PRIORITY_BITS      as byte = $03
CANSPI_TX_PRIORITY_0         as byte = $FC   ' XXXXXX00
CANSPI_TX_PRIORITY_1         as byte = $FD   ' XXXXXX01
CANSPI_TX_PRIORITY_2         as byte = $FE   ' XXXXXX10
CANSPI_TX_PRIORITY_3         as byte = $FF   ' XXXXXX11

CANSPI_TX_FRAME_BIT          as byte = $08
CANSPI_TX_STD_FRAME          as byte = $FF   ' XXXXX1XX
CANSPI_TX_XTD_FRAME          as byte = $F7   ' XXXXX0XX

CANSPI_TX_RTR_BIT            as byte = $40
CANSPI_TX_NO_RTR_FRAME       as byte = $FF   ' X1XXXXXX
CANSPI_TX_RTR_FRAME          as byte = $BF   ' X0XXXXXX

```

You may use bitwise and to adjust the appropriate flags. For example:

```

' form value to be used with CANSendMessage:
send_config = CANSPI_TX_PRIORITY_0 and
              CANSPI_TX_XTD_FRAME  and
              CANSPI_TX_NO_RTR_FRAME

...
CANSPI1Write(id, data, 1, send_config)

```

CANSPI_RX_MSG_FLAGS

CANSPI_RX_MSG_FLAGS are flags related to reception of CAN message. If a particular bit is set then corresponding meaning is TRUE otherwise it will be FALSE.

```
const
    CANSPI_RX_FILTER_BITS      as byte = $07  ' Use this to access
filter bits
    CANSPI_RX_FILTER_1        as byte = $00
    CANSPI_RX_FILTER_2        as byte = $01
    CANSPI_RX_FILTER_3        as byte = $02
    CANSPI_RX_FILTER_4        as byte = $03
    CANSPI_RX_FILTER_5        as byte = $04
    CANSPI_RX_FILTER_6        as byte = $05

    CANSPI_RX_OVERFLOW        as byte = $08  ' Set if Overflowed
else cleared
    CANSPI_RX_INVALID_MSG     as byte = $10  ' Set if invalid
else cleared
    CANSPI_RX_XTD_FRAME       as byte = $20  ' Set if XTD mes-
sage else cleared
    CANSPI_RX_RTR_FRAME       as byte = $40  ' Set if RTR mes-
sage else cleared
    CANSPI_RX_DBL_BUFFERED    as byte = $80  ' Set if this mes-
sage was hardware double-buffered
```

You may use bitwise and to adjust the appropriate flags. For example:

```
if (MsgFlag and CANSPI_RX_OVERFLOW) <> 0 then
    ...
    ' Receiver overflow has occurred.
    ' We have lost our previous message.
end if
```

CANSPI_MASK

The CANSPI_MASK constants define mask codes. Function CANSPISetMask expects one of these as it's argument:

```
const
    CANSPI_MASK_B1 as byte = 0
    CANSPI_MASK_B2 as byte = 1
```

CANSPI_FILTER

The CANSPI_FILTER constants define filter codes. Functions CANSPISetFilter expects one of these as it's argument:

```

const
    CANSPI_FILTER_B1_F1 as byte = 0
    CANSPI_FILTER_B1_F2 as byte = 1
    CANSPI_FILTER_B2_F1 as byte = 2
    CANSPI_FILTER_B2_F2 as byte = 3
    CANSPI_FILTER_B2_F3 as byte = 4
    CANSPI_FILTER_B2_F4 as byte = 5

```

Library Example

This is a simple demonstration of CANSPI Library routines usage. First node initiates the communication with the second node by sending some data to its address. The second node responds by sending back the data incremented by 1. First node then does the same and sends incremented data back to second node, etc.

Code for the first CANSPI node:

```

program Can_Spi_1st

dim Can_Init_Flags, Can_Send_Flags, Can_Rcv_Flags as byte ' can flags
    Rx_Data_Len as byte ' received data length in bytes
    RxTx_Data as byte[ 8] ' can rx/tx data buffer
    Msg_Rcvd as byte ' reception flag
    Tx_ID, Rx_ID as longint ' can rx and tx ID

' CANSPI module connections
dim CanSpi_CS as sbit at PORTB.B0
    CanSpi_CS_Direction as sbit at DDRB.B0
    CanSpi_Rst as sbit at PORTB.B2
    CanSpi_Rst_Direction as sbit at DDRB.B2
' End CANSPI module connections

main:
    ADCSRA.7 = 0 ' Set AN pins to Digital I/O
    PORTC = 0
    DDRC = 255

    Can_Init_Flags = 0 '
    Can_Send_Flags = 0 ' clear flags
    Can_Rcv_Flags = 0 '

    Can_Send_Flags = _CANSPI_TX_PRIORITY_0 and ' form value to be used
        _CANSPI_TX_XTD_FRAME and ' with CANSPIwrite
        _CANSPI_TX_NO_RTR_FRAME

    Can_Init_Flags = _CANSPI_CONFIG_SAMPLE_THRICE and ' form value to be
used
        _CANSPI_CONFIG_PHSEG2_PRG_ON and ' with CANSPIInit
        _CANSPI_CONFIG_XTD_MSG and
        _CANSPI_CONFIG_DBL_BUFFER_ON and
        _CANSPI_CONFIG_VALID_XTD_MSG

```

```

SPI1_Init()                                ' initialize SPI1 module
  Spi_Rd_Ptr = @SPI1_Read                    '
Pass pointer to SPI Read sub function of used SPI module
  CANSPIInitialize(1,3,3,3,1,Can_Init_Flags) '
Initialize external CANSPI module
  CANSPISetOperationMode(_CANSPI_MODE_CONFIG,0xFF) '
set CONFIGURATION mode
  CANSPISetMask(_CANSPI_MASK_B1,-1,_CANSPI_CONFIG_XTD_MSG) '
set all mask1 bits to ones
  CANSPISetMask(_CANSPI_MASK_B2,-1,_CANSPI_CONFIG_XTD_MSG) '
set all mask2 bits to ones
  CANSPISetFilter(_CANSPI_FILTER_B2_F4,3,_CANSPI_CONFIG_XTD_MSG) '
set id of filter B1_F1 to 3

  CANSPISetOperationMode(_CANSPI_MODE_NORMAL,0xFF)' set NORMAL mode

  RxTx_Data[ 0] = 9                          ' set initial data to be sent

  Tx_ID = 12111                              ' set transmit ID

  CANSPIWrite(Tx_ID, RxTx_Data, 1, Can_Send_Flags) '
send initial message
  while TRUE                                  ' endless loop
    Msg_Rcvd = CANSPIRead(Rx_ID , RxTx_Data , Rx_Data_Len,
Can_Rcv_Flags) ' receive message
    if ((Rx_ID = 3) and Msg_Rcvd) then
' if message received check id
      PORTC = RxTx_Data[ 0] ' id correct, output data at PORTC
      Inc(RxTx_Data[ 0]) ' increment received data
      Delay_ms(10)
      CANSPIWrite(Tx_ID, RxTx_Data, 1, Can_Send_Flags)
' send incremented data back
    end if
  wend
end.

```

Code for the second CANSPI node:

```

program Can_Spi_2nd

dim Can_Init_Flags, Can_Send_Flags, Can_Rcv_Flags as byte ' can flags
  Rx_Data_Len as byte ' received data length in bytes
  RxTx_Data as byte[ 8] ' CAN rx/tx data buffer
  Msg_Rcvd as byte ' reception flag
  Tx_ID, Rx_ID as longint ' can rx and tx ID

```

```

' CANSPI module connections
dim CanSpi_CS as sbit at PORTB.B0
    CanSpi_CS_Direction as sbit at DDRB.B0
    CanSpi_Rst as sbit at PORTB.B2
    CanSpi_Rst_Direction as sbit at DDRB.B2
' End CANSPI module connections

main:
    PORTC = 0                ' clear PORTC
    DDRC = 255              ' set PORTC as output

    Can_Init_Flags = 0      '
    Can_Send_Flags = 0      ' clear flags
    Can_Rcv_Flags = 0      '

    Can_Send_Flags = _CANSPI_TX_PRIORITY_0 and ' form value to be used
        _CANSPI_TX_XTD_FRAME and ' with CANSPIWrite
        _CANSPI_TX_NO_RTR_FRAME

    Can_Init_Flags = _CANSPI_CONFIG_SAMPLE_THRICE and ' Form value
to be used
        _CANSPI_CONFIG_PHSEG2_PRG_ON and '
with CANSPIInit
        _CANSPI_CONFIG_XTD_MSG and
        _CANSPI_CONFIG_DBL_BUFFER_ON and
        _CANSPI_CONFIG_VALID_XTD_MSG and
        _CANSPI_CONFIG_LINE_FILTER_OFF

    SPI1_Init()
initialize SPI1 module
Spi_Rd_Ptr = @SPI1_Read
' Pass pointer to SPI Read sub function of used SPI module
CANSPIInitialize(1,3,3,3,1,Can_Init_Flags)
' initialize external CANSPI module
CANSPISetOperationMode(_CANSPI_MODE_CONFIG,0xFF)
' set CONFIGURATION mode
CANSPISetMask(_CANSPI_MASK_B1,-1,_CANSPI_CONFIG_XTD_MSG)
' set all mask1 bits to ones
CANSPISetMask(_CANSPI_MASK_B2,-1,_CANSPI_CONFIG_XTD_MSG)
' set all mask2 bits to ones
CANSPISetFilter(_CANSPI_FILTER_B2_F3,12111,_CANSPI_CONFIG_XTD_MSG)
' set id of filter B1_F1 to 3
CANSPISetOperationMode(_CANSPI_MODE_NORMAL,0xFF)
' set NORMAL mode
Tx_ID = 3                ' set tx ID

```

```

while TRUE                               ' endless loop
    Msg_Rcvd = CANSPiRead(Rx_ID , RxTx_Data , Rx_Data_Len,
Can_Rcv_Flags) ' receive message
    if ((Rx_ID = 12111) and Msg_Rcvd) then
' if message received check id
        PORTC = RxTx_Data[ 0] ' id correct, output data at PORTC
        Inc(RxTx_Data[ 0])    ' increment received data
        CANSPiWrite(Tx_ID, RxTx_Data, 1, Can_Send_Flags)
' send incremented data back
    end if
wend
end.

```

HW Connection

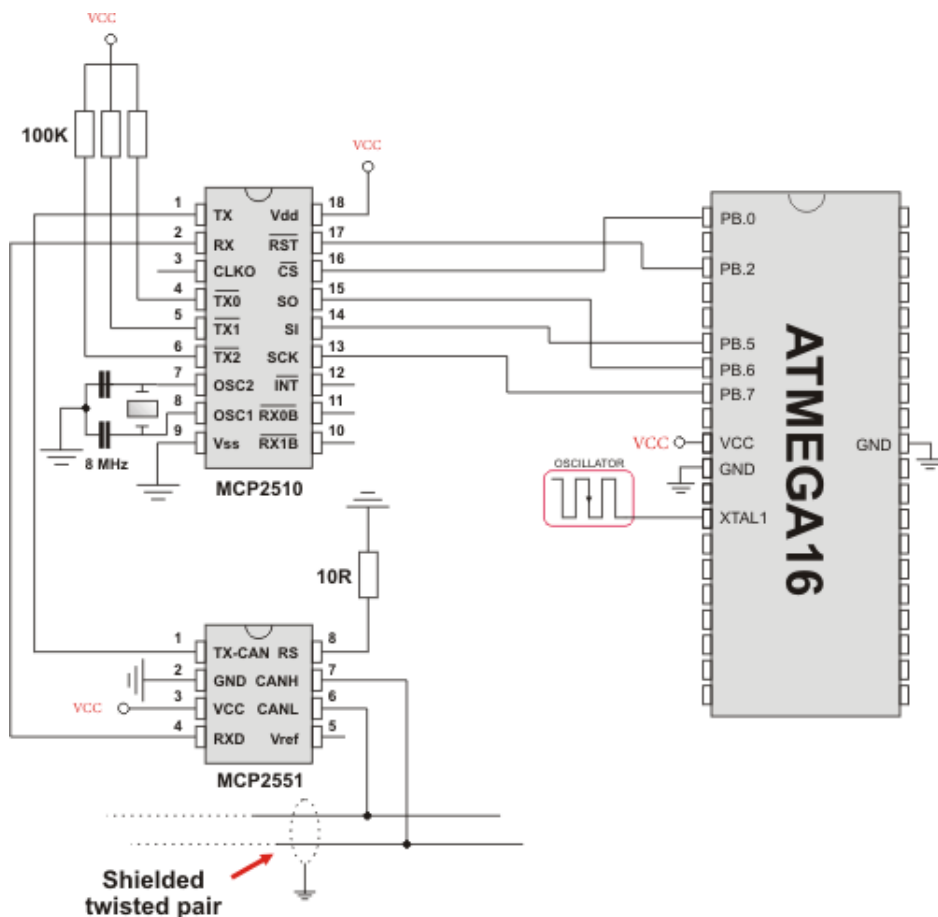

Example of interfacing CAN transceiver MCP2510 with MCU via SPI interface

COMPACT FLASH LIBRARY

The Compact Flash Library provides routines for accessing data on Compact Flash card (abbr. CF further in text). CF cards are widely used memory elements, commonly used with digital cameras. Great capacity and excellent access time of only a few microseconds make them very attractive for the microcontroller applications.

In CF card, data is divided into sectors. One sector usually comprises 512 bytes. Routines for file handling, the Cf_Fat routines, are not performed directly but successively through 512B buffer.

Note: Routines for file handling can be used only with FAT16 file system.

Note: Library functions create and read files from the root directory only.

Note: Library functions populate both FAT1 and FAT2 tables when writing to files, but the file data is being read from the FAT1 table only; i.e. there is no recovery if the FAT1 table gets corrupted.

Note: If MMC/SD card has Master Boot Record (MBR), the library will work with the first available primary (logical) partition that has non-zero size. If MMC/SD card has Volume Boot Record (i.e. there is only one logical partition and no MBRs), the library works with entire card as a single partition. For more information on MBR, physical and logical drives, primary/secondary partitions and partition tables, please consult other resources, e.g. Wikipedia and similar.

Note: Before writing operation, make sure not to overwrite boot or FAT sector as it could make your card on PC or digital camera unreadable. Drive mapping tools, such as Winhex, can be of great assistance.

External dependencies of Compact Flash Library

The following variables must be defined in all projects using Compact Flash Library:	Description:	Example :
<code>dim CF_Data_Port as byte sfr external</code>	Compact Flash Data Port.	<code>dim CF_Data_Port as byte at PORTD</code>
<code>dim CF_Data_Port_Direction as byte sfr external</code>	Direction of the Compact Flash Data Port.	<code>dim CF_Data_Port_Direction as byte at DDRD</code>
<code>dim CF_RDY as sbit sfr external</code>	Ready signal line.	<code>dim CF_RDY as sbit at PINB.B7</code>
<code>dim CF_WE as sbit sfr external</code>	Write Enable signal line.	<code>dim CF_WE as sbit at PORTB.B6</code>
<code>dim CF_OE as sbit sfr external</code>	Output Enable signal line.	<code>dim CF_OE as sbit at PORTB.B5</code>
<code>dim CF_CD1 as sbit sfr external</code>	Chip Detect signal line.	<code>dim CF_CD1 as sbit at PINB.B4</code>
<code>dim CF_CE1 as sbit sfr external</code>	Chip Enable signal line.	<code>dim CF_CE1 as sbit at PORTB.B3</code>
<code>dim CF_A2 as sbit sfr external</code>	Address pin 2.	<code>dim CF_A2 as sbit at PORTB.B2</code>
<code>dim CF_A1 as sbit sfr external</code>	Address pin 1.	<code>dim CF_A1 as sbit at PORTB.B1</code>
<code>dim CF_A0 as sbit sfr external</code>	Address pin 0.	<code>dim CF_A0 as sbit at PORTB.B0</code>
<code>dim CF_RDY_direction as sbit sfr external</code>	Direction of the Ready pin.	<code>dim CF_RDY_direction as sbit at DDRB.B7</code>
<code>dim CF_WE_direction as sbit sfr external</code>	Direction of the Write Enable pin.	<code>dim CF_WE_direction as sbit at DDRB.B6</code>
<code>dim CF_OE_direction as sbit sfr external</code>	Direction of the Output Enable pin.	<code>dim CF_OE_direction as sbit at DDRB.B5</code>
<code>dim CF_CD1_direction as sbit sfr external</code>	Direction of the Chip Detect pin.	<code>dim CF_CD1_direction as sbit at DDRB.B4</code>
<code>dim CF_CE1_direction as sbit sfr external</code>	Direction of the Chip Enable pin.	<code>dim CF_CE1_direction as sbit at DDRB.B3</code>
<code>dim CF_A2_direction as sbit sfr external</code>	Direction of the Address 2 pin.	<code>dim CF_A2_direction as sbit at DDRB.B2</code>
<code>dim CF_A1_direction as sbit sfr external</code>	Direction of the Address 1 pin.	<code>dim CF_A1_direction as sbit at DDRB.B1</code>
<code>dim CF_A0_direction as sbit sfr external</code>	Direction of the Address 0 pin.	<code>dim CF_A0_direction as sbit at DDRB.B0</code>

Library Routines

- Cf_Init
- Cf_Detect
- Cf_Enable
- Cf_Disable
- Cf_Read_Init
- Cf_Read_Byte
- Cf_Write_Init
- Cf_Write_Byte
- Cf_Read_Sector
- Cf_Write_Sector

Routines for file handling:

- Cf_Fat_Init
- Cf_Fat_QuickFormat
- Cf_Fat_Assign
- Cf_Fat_Reset
- Cf_Fat_Read
- Cf_Fat_Rewrite
- Cf_Fat_Append
- Cf_Fat_Delete
- Cf_Fat_Write
- Cf_Fat_Set_File_Date
- Cf_Fat_Get_File_Date
- Cf_Fat_Get_File_Size
- Cf_Fat_Get_Swap_File

Cf_Init

Prototype	<code>sub procedure Cf_Init()</code>
Returns	Nothing.
Description	Initializes ports appropriately for communication with CF card.
Requires	<p>Global variables :</p> <ul style="list-style-type: none"> - <code>CF_Data_Port</code> : Compact Flash data port - <code>CF_RDY</code> : Ready signal line - <code>CF_WE</code> : Write enable signal line - <code>CF_OE</code> : Output enable signal line - <code>CF_CD1</code> : Chip detect signal line - <code>CF_CE1</code> : Enable signal line - <code>CF_A2</code> : Address pin 2 - <code>CF_A1</code> : Address pin 1 - <code>CF_A0</code> : Address pin 0 <ul style="list-style-type: none"> - <code>CF_Data_Port_direction</code> : Direction of the Compact Flash data direction port - <code>CF_RDY_direction</code> : Direction of the Ready pin - <code>CF_WE_direction</code> : Direction of the Write enable pin - <code>CF_OE_direction</code> : Direction of the Output enable pin - <code>CF_CD1_direction</code> : Direction of the Chip detect pin - <code>CF_CE1_direction</code> : Direction of the Chip enable pin - <code>CF_A2_direction</code> : Direction of the Address 2 pin - <code>CF_A1_direction</code> : Direction of the Address 1 pin - <code>CF_A0_direction</code> : Direction of the Address 0 pin <p>must be defined before using this function.</p>
Example	<pre>' set compact flash pinout dim CF_Data_Port as byte at PORTD dim Cf_Data_Port_Direction as byte at DDRD dim CF_RDY as sbit at PINB.B7 dim CF_WE as sbit at PORTB.B6 dim CF_OE as sbit at PORTB.B5 dim CF_CD1 as sbit at PINB.B4 dim CF_CE1 as sbit at PORTB.B3 dim CF_A2 as sbit at PORTB.B2 dim CF_A1 as sbit at PORTB.B1 dim CF_A0 as sbit at PORTB.B0 dim CF_RDY_direction as sbit at DDRB.B7 dim CF_WE_direction as sbit at DDRB.B6 dim CF_OE_direction as sbit at DDRB.B5 dim CF_CD1_direction as sbit at DDRB.B4 dim CF_CE1_direction as sbit at DDRB.B3 dim CF_A2_direction as sbit at DDRB.B2 dim CF_A1_direction as sbit at DDRB.B1 dim CF_A0_direction as sbit at DDRB.B0 ' end of cf pinout 'Init CF Cf_Init()</pre>

Cf_Detect

Prototype	<code>sub function Cf_Detect() as byte</code>
Returns	- 1 - if CF card was detected - 0 - otherwise
Description	Checks for presence of CF card by reading the <code>chip detect</code> pin.
Requires	The corresponding MCU ports must be appropriately initialized for CF card. See <code>Cf_Init</code> .
Example	<pre>' Wait until CF card is inserted: while (Cf_Detect() = 0) nop wend</pre>

Cf_Enable

Prototype	<code>sub procedure Cf_Enable()</code>
Returns	Nothing.
Description	Enables the device. Routine needs to be called only if you have disabled the device by means of the <code>Cf_Disable</code> routine. These two routines in conjunction allow you to free/occupy data line when working with multiple devices.
Requires	The corresponding MCU ports must be appropriately initialized for CF card. See <code>Cf_Init</code> .
Example	<pre>' enable compact flash Cf_Enable()</pre>

Cf_Disable

Prototype	<code>sub procedure Cf_Disable()</code>
Returns	Nothing.
Description	Routine disables the device and frees the data lines for other devices. To enable the device again, call <code>Cf_Enable</code> . These two routines in conjunction allow you to free/occupy data line when working with multiple devices.
Requires	The corresponding MCU ports must be appropriately initialized for CF card. See <code>Cf_Init</code> .
Example	<pre>' disable compact flash Cf_Disable()</pre>

Cf_Read_Init

Prototype	<code>sub procedure Cf_Read_Init(dim address as longword, dim sector_count as byte)</code>
Returns	Nothing.
Description	<p>Initializes CF card for reading.</p> <p>Parameters :</p> <ul style="list-style-type: none"> - <code>address</code>: the first sector to be prepared for reading operation. - <code>sector_count</code>: number of sectors to be prepared for reading operation.
Requires	The corresponding MCU ports must be appropriately initialized for CF card. See <code>Cf_Init</code> .
Example	<pre>' initialize compact flash for reading from sector 590 Cf_Read_Init(590, 1)</pre>

Cf_Read_Byte

Prototype	<code>sub function CF_Read_Byte() as byte</code>
Returns	<p>Returns a byte read from Compact Flash sector buffer.</p> <p>Note: Higher byte of the unsigned return value is cleared.</p>
Description	Reads one byte from Compact Flash sector buffer location currently pointed to by internal read pointers. These pointers will be autoincremented upon reading.
Requires	<p>The corresponding MCU ports must be appropriately initialized for CF card. See <code>Cf_Init</code>.</p> <p>CF card must be initialized for reading operation. See <code>Cf_Read_Init</code>.</p>
Example	<pre>' Read a byte from compact flash: dim data as byte ... data = Cf_Read_Byte()</pre>

Cf_Write_Init

Prototype	<code>sub procedure Cf_Write_Init(dim address as longword, dim sectcnt as byte)</code>
Returns	Nothing.
Description	<p>Initializes CF card for writing.</p> <p>Parameters :</p> <ul style="list-style-type: none"> - <code>address</code>: the first sector to be prepared for writing operation. - <code>sectcnt</code>: number of sectors to be prepared for writing operation.
Requires	The corresponding MCU ports must be appropriately initialized for CF card. See Cf_Init.
Example	<pre>' initialize compact flash for writing to sector 590 Cf_Write_Init(590, 1)</pre>

Cf_Write_Byte

Prototype	<code>sub procedure Cf_Write_Byte(dim data_ as byte)</code>
Returns	Nothing.
Description	<p>Writes a byte to Compact Flash sector buffer location currently pointed to by writing pointers. These pointers will be autoincremented upon reading. When sector buffer is full, its content will be transferred to appropriate flash memory sector.</p> <p>Parameters :</p> <ul style="list-style-type: none"> - <code>data_</code>: byte to be written.
Requires	<p>The corresponding MCU ports must be appropriately initialized for CF card. See Cf_Init.</p> <p>CF card must be initialized for writing operation. See Cf_Write_Init.</p>
Example	<pre>dim data_ as byte ... data = 0xAA Cf_Write_Byte(data)</pre>

Cf_Read_Sector

Prototype	<code>sub procedure Cf_Read_Sector(dim sector_number as longword, dim byref buffer as byte[512])</code>
Returns	Nothing.
Description	<p>Reads one sector (512 bytes). Read data is stored into buffer provided by the buffer parameter.</p> <p>Parameters :</p> <ul style="list-style-type: none"> - <code>sector_number</code>: sector to be read. - <code>buffer</code>: data buffer of at least 512 bytes in length.
Requires	The corresponding MCU ports must be appropriately initialized for CF card. See Cf_Init.
Example	<pre>' read sector 22 dim data as array[512] of byte ... Cf_Read_Sector(22, data)</pre>

Cf_Write_Sector

Prototype	<code>sub procedure Cf_Write_Sector(dim sector_number as longword, dim byref buffer as byte[512])</code>
Returns	Nothing.
Description	<p>Writes 512 bytes of data provided by the buffer parameter to one CF sector.</p> <p>Parameters :</p> <ul style="list-style-type: none"> - <code>sector_number</code>: sector to be written to. - <code>buffer</code>: data buffer of 512 bytes in length.
Requires	The corresponding MCU ports must be appropriately initialized for CF card. See Cf_Init.
Example	<pre>' write to sector 22 dim data as array[512] of byte ... Cf_Write_Sector(22, data)</pre>

Cf_Fat_Init

Prototype	<code>sub function Cf_Fat_Init() as byte</code>
Returns	<ul style="list-style-type: none"> - 0 - if CF card was detected and successfully initialized - 1 - if FAT16 boot sector was not found - 255 - if card was not detected
Description	Initializes CF card, reads CF FAT16 boot sector and extracts data needed by the library.
Requires	Nothing.
Example	<pre>init the FAT library if (Cf_Fat_Init() = 0) then ... end if</pre>

Cf_Fat_QuickFormat

Prototype	<code>sub function Cf_Fat_QuickFormat(dim byref cf_fat_label as string[11]) as byte</code>
Returns	<ul style="list-style-type: none"> - 0 - if CF card was detected, successfully formatted and initialized - 1 - if FAT16 format was unseccessful - 255 - if card was not detected
Description	<p>Formats to FAT16 and initializes CF card.</p> <p>Parameters :</p> <ul style="list-style-type: none"> - <code>cf_fat_label</code>: volume label (11 characters in length). If less than 11 characters are provided, the label will be padded with spaces. If an empty string is passed, the volume will not be labeled. <p>Note: This routine can be used instead or in conjunction with the Cf_Fat_Init routine.</p> <p>Note: If CF card already contains a valid boot sector, it will remain unchanged (except volume label field) and only FAT and ROOT tables will be erased. Also, the new volume label will be set.</p>
Requires	Nothing.
Example	<pre>'--- format and initialize the FAT library if (Cf_Fat_QuickFormat('mikroE') = 0) then ... end if</pre>

Cf_Fat_Assign

Prototype	<code>sub function Cf_Fat_Assign(dim byref filename as char[12], dim file_cre_attr as byte) as byte</code>																											
Returns	<ul style="list-style-type: none"> - 0 if file does not exist and no new file is created. - 1 if file already exists or file does not exist but a new file is created. 																											
Description	<p>Assigns file for file operations (read, write, delete...). All subsequent file operations will be applied to the assigned file.</p> <p>Parameters :</p> <ul style="list-style-type: none"> - <code>filename</code>: name of the file that should be assigned for file operations. The file name should be in DOS 8.3 (file_name.extension) format. The file name and extension will be automatically padded with spaces by the library if they have less than length required (i.e. "mikro.tx" -> "mikro .tx "), so the user does not have to take care of that. The file name and extension are case insensitive. The library will convert them to the proper case automatically, so the user does not have to take care of that. Also, in order to keep backward compatibility with the first version of this library, file names can be entered as UPPERCASE string of 11 bytes in length with no dot character between the file name and extension (i.e. "MIKROELETXT" -> MIKROELE.TXT). In this case the last 3 characters of the string are considered to be file extension. - <code>file_cre_attr</code>: file creation and attributs flags. Each bit corresponds to the appropriate file attribut: <table border="1" style="width: 100%; border-collapse: collapse;"> <thead> <tr> <th style="width: 10%;">Bit</th> <th style="width: 15%;">Mask</th> <th style="width: 75%;">Description</th> </tr> </thead> <tbody> <tr> <td style="text-align: center;">0</td> <td style="text-align: center;">0x01</td> <td>Read Only</td> </tr> <tr> <td style="text-align: center;">1</td> <td style="text-align: center;">0x02</td> <td>Hidden</td> </tr> <tr> <td style="text-align: center;">2</td> <td style="text-align: center;">0x04</td> <td>System</td> </tr> <tr> <td style="text-align: center;">3</td> <td style="text-align: center;">0x08</td> <td>Volume Label</td> </tr> <tr> <td style="text-align: center;">4</td> <td style="text-align: center;">0x10</td> <td>Subdirectory</td> </tr> <tr> <td style="text-align: center;">5</td> <td style="text-align: center;">0x20</td> <td>Archive</td> </tr> <tr> <td style="text-align: center;">6</td> <td style="text-align: center;">0x40</td> <td>Device (internal use only, never found on disk)</td> </tr> <tr> <td style="text-align: center;">7</td> <td style="text-align: center;">0x80</td> <td>File creation flag. If the file does not exist and this flag is set, a new file with specified name will be created.</td> </tr> </tbody> </table> <p>Note: Long File Names (LFN) are not supported.</p>	Bit	Mask	Description	0	0x01	Read Only	1	0x02	Hidden	2	0x04	System	3	0x08	Volume Label	4	0x10	Subdirectory	5	0x20	Archive	6	0x40	Device (internal use only, never found on disk)	7	0x80	File creation flag. If the file does not exist and this flag is set, a new file with specified name will be created.
Bit	Mask	Description																										
0	0x01	Read Only																										
1	0x02	Hidden																										
2	0x04	System																										
3	0x08	Volume Label																										
4	0x10	Subdirectory																										
5	0x20	Archive																										
6	0x40	Device (internal use only, never found on disk)																										
7	0x80	File creation flag. If the file does not exist and this flag is set, a new file with specified name will be created.																										
Requires	CF card and CF library must be initialized for file operations. See Cf_Fat_Init.																											
Example	<code>' create file with archive attribut if it does not already exist Cf_Fat_Assign('MIKRO007.TXT',0xA0)</code>																											

Cf_Fat_Reset

Prototype	<code>sub procedure Cf_Fat_Reset(dim byref size as longword)</code>
Returns	Nothing.
Description	<p>Opens currently assigned file for reading.</p> <p>Parameters :</p> <p>- <code>size</code>: buffer to store file size to. After file has been open for reading its size is returned through this parameter.</p>
Requires	<p>CF card and CF library must be initialized for file operations. See Cf_Fat_Init.</p> <p>File must be previously assigned. See Cf_Fat_Assign.</p>
Example	<pre>dim size as longword ... Cf_Fat_Reset(size)</pre>

Cf_Fat_Read

Prototype	<code>sub procedure Cf_Fat_Read(dim byref bdata as byte)</code>
Returns	Nothing.
Description	<p>Reads a byte from currently assigned file opened for reading. Upon function execution file pointers will be set to the next character in the file.</p> <p>Parameters :</p> <p>- <code>bdata</code>: buffer to store read byte to. Upon this function execution read byte is returned through this parameter.</p>
Requires	<p>CF card and CF library must be initialized for file operations. See Cf_Fat_Init.</p> <p>File must be previously assigned. See Cf_Fat_Assign.</p> <p>File must be open for reading. See Cf_Fat_Reset.</p>
Example	<pre>dim character as byte ... Cf_Fat_Read(character)</pre>

Cf_Fat_Rewrite

Prototype	<code>sub procedure Cf_Fat_Rewrite()</code>
Returns	Nothing.
Description	Opens currently assigned file for writing. If the file is not empty its content will be erased.
Requires	CF card and CF library must be initialized for file operations. See Cf_Fat_Init. The file must be previously assigned. See Cf_Fat_Assign.
Example	<code>' open file for writing Cf_Fat_Rewrite()</code>

Cf_Fat_Append

Prototype	<code>sub procedure Cf_Fat_Append()</code>
Returns	Nothing.
Description	Opens currently assigned file for appending. Upon this function execution file pointers will be positioned after the last byte in the file, so any subsequent file writing operation will start from there.
Requires	CF card and CF library must be initialized for file operations. See Cf_Fat_Init. File must be previously assigned. See Cf_Fat_Assign.
Example	<code>' open file for appending Cf_Fat_Append()</code>

Cf_Fat_Delete

Prototype	<code>sub procedure Cf_Fat_Delete()</code>
Returns	Nothing.
Description	Deletes currently assigned file from CF card.
Requires	CF card and CF library must be initialized for file operations. See Cf_Fat_Init. File must be previously assigned. See Cf_Fat_Assign.
Example	<code>' delete current file Cf_Fat_Delete()</code>

Cf_Fat_Write

Prototype	<code>sub procedure Cf_Fat_Write(dim byref fdata as byte[512], dim data_len as word)</code>
Returns	Nothing.
Description	Writes requested number of bytes to currently assigned file opened for writing. Parameters : - <code>fdata</code> : data to be written. - <code>data_len</code> : number of bytes to be written.
Requires	CF card and CF library must be initialized for file operations. See Cf_Fat_Init. File must be previously assigned. See Cf_Fat_Assign. File must be open for writing. See Cf_Fat_Rewrite or Cf_Fat_Append.
Example	<code>dim file_contents as array[42] of byte</code> <code>...</code> <code>Cf_Fat_Write(file_contents, 42) ' write data to the assigned file</code>

Cf_Fat_Set_File_Date

Prototype	<code>sub procedure Cf_Fat_Set_File_Date(dim year as word, dim month as byte, dim day as byte, dim hours as byte, dim mins as byte, dim seconds as byte)</code>
Returns	Nothing.
Description	Sets the date/time stamp. Any subsequent file writing operation will write this stamp to currently assigned file's time/date attributes. Parameters : - <code>year</code> : year attribute. Valid values: 1980-2107 - <code>month</code> : month attribute. Valid values: 1-12 - <code>day</code> : day attribute. Valid values: 1-31 - <code>hours</code> : hours attribute. Valid values: 0-23 - <code>mins</code> : minutes attribute. Valid values: 0-59 - <code>seconds</code> : seconds attribute. Valid values: 0-59
Requires	CF card and CF library must be initialized for file operations. See Cf_Fat_Init. File must be previously assigned. See Cf_Fat_Assign. File must be open for writing. See Cf_Fat_Rewrite or Cf_Fat_Append.
Example	<code>Cf_Fat_Set_File_Date(2005, 9, 30, 17, 41, 0)</code>

Cf_Fat_Get_File_Date

Prototype	<code>sub procedure Cf_Fat_Get_File_Date(dim byref year as word, dim byref month as byte, dim byref day as byte, dim byref hours as byte, dim byref mins as byte)</code>
Returns	Nothing.
Description	<p>Reads time/date attributes of currently assigned file.</p> <p>Parameters :</p> <ul style="list-style-type: none"> - <code>year</code>: buffer to store year attribute to. Upon function execution year attribute is returned through this parameter. - <code>month</code>: buffer to store month attribute to. Upon function execution month attribute is returned through this parameter. - <code>day</code>: buffer to store day attribute to. Upon function execution day attribute is returned through this parameter. - <code>hours</code>: buffer to store hours attribute to. Upon function execution hours attribute is returned through this parameter. - <code>mins</code>: buffer to store minutes attribute to. Upon function execution minutes attribute is returned through this parameter.
Requires	<p>CF card and CF library must be initialized for file operations. See Cf_Fat_Init.</p> <p>File must be previously assigned. See Cf_Fat_Assign.</p>
Example	<pre>dim year as word month, day, hours, mins as byte ... Cf_Fat_Get_File_Date(year, month, day, hours, mins)</pre>

Cf_Fat_Get_File_Size

Prototype	<code>sub function Cf_Fat_Get_File_Size() as longword</code>
Returns	Size of the currently assigned file in bytes.
Description	This function reads size of currently assigned file in bytes.
Requires	<p>CF card and CF library must be initialized for file operations. See Cf_Fat_Init.</p> <p>File must be previously assigned. See Cf_Fat_Assign.</p>
Example	<pre>dim my_file_size as longword ... my_file_size = Cf_Fat_Get_File_Size()</pre>

Cf_Fat_Get_Swap_File

Prototype	<code>sub function Cf_Fat_Get_Swap_File(dim sectors_cnt as longint, dim byref filename as string[11], dim file_attr as byte) as longword</code>
Returns	<ul style="list-style-type: none"> - Number of the start sector for the newly created swap file, if there was enough free space on CF card to create file of required size. - 0 - otherwise.
Description	<p>This function is used to create a swap file of predefined name and size on the CF media. If a file with specified name already exists on the media, search for consecutive sectors will ignore sectors occupied by this file. Therefore, it is recommended to erase such file if it exists before calling this function. If it is not erased and there is still enough space for a new swap file, this function will delete it after allocating new memory space for a new swap file.</p> <p>The purpose of the swap file is to make reading and writing to CF media as fast as possible, by using the Cf_Read_Sector() and Cf_Write_Sector() functions directly, without potentially damaging the FAT system. The swap file can be considered as a "window" on the media where the user can freely write/read data. Its main purpose in the mikroBasic's library is to be used for fast data acquisition; when the time-critical acquisition has finished, the data can be re-written into a "normal" file, and formatted in the most suitable way.</p> <p>Parameters:</p> <ul style="list-style-type: none"> - <code>sectors_cnt</code>: number of consecutive sectors that user wants the swap file to have. - <code>filename</code>: name of the file that should be assigned for file operations. The file name should be in DOS 8.3 (file_name.extension) format. The file name and extension will be automatically padded with spaces by the library if they have less than length required (i.e. "mikro.tx" -> "mikro .tx "), so the user does not have to take care of that. The file name and extension are case insensitive. The library will convert them to the proper case automatically, so the user does not have to take care of that. <p>Also, in order to keep backward compatibility with the first version of this library, file names can be entered as UPPERCASE string of 11 bytes in length with no dot character between the file name and extension (i.e. "MIKROELETXT" -> MIKROELE.TXT). In this case the last 3 characters of the string are considered to be file extension.</p> <ul style="list-style-type: none"> - <code>file_attr</code>: file creation and attributs flags. Each bit corresponds to the appropriate file attribut:

Description	Bit	Mask	Description
	0	0x01	Read Only
	1	0x02	Hidden
	2	0x04	System
	3	0x08	Volume Label
	4	0x10	Subdirectory
	5	0x20	Archive
	6	0x40	Device (internal use only, never found on disk)
	7	0x80	Not used
Note: Long File Names (LFN) are not supported.			
Requires	CF card and CF library must be initialized for file operations. See Cf_Fat_Init.		
Example	<pre> program '----- Try to create a swap file with archive attribute, whose size will be at least 1000 sectors. ' If it succeeds, it sends the No. of start sec- tor over USART dim size as longword ... main: ... size = Cf_Fat_Get_Swap_File(1000, "mikroE.txt", 0x20) if size then UART1_Write(0xAA) UART1_Write(Lo(size)) UART1_Write(Hi(size)) UART1_Write(Higher(size)) UART1_Write(Highest(size)) UART1_Write(0xAA) end if end. </pre>		

Library Example

The following example is a simple demonstration of CF(Compact Flash) Library which shows how to use CF card data accessing routines.

```

program CF_Fat16_Test

dim
  ' set compact flash pinout
  Cf_Data_Port as byte at PORTD
  Cf_Data_Port_Direction as byte at DDRD

  CF_RDY as sbit at PINB.B7
  CF_WE as sbit at PORTB.B6
  CF_OE as sbit at PORTB.B5
  CF_CD1 as sbit at PINB.B4
  CF_CE1 as sbit at PORTB.B3
  CF_A2 as sbit at PORTB.B2
  CF_A1 as sbit at PORTB.B1
  CF_A0 as sbit at PORTB.B0

  CF_RDY_direction as sbit at DDRB.B7
  CF_WE_direction as sbit at DDRB.B6
  CF_OE_direction as sbit at DDRB.B5
  CF_CD1_direction as sbit at DDRB.B4
  CF_CE1_direction as sbit at DDRB.B3
  CF_A2_direction as sbit at DDRB.B2
  CF_A1_direction as sbit at DDRB.B1
  CF_A0_direction as sbit at DDRB.B0
  ' end of cf pinout

  FAT_TXT as string[ 20]
  file_contents as string[ 50]

  filename as string[ 14]      ' File names

  character as byte
  loop_, loop2 as byte
  size as longint

  Buffer as byte[ 512]

  '----- Writes string to USART
  sub procedure Write_Str(dim byref ostr as byte[ 2] )
  dim
    i as byte

```

```

i = 0
  while ostr[i] <> 0
    UART1_Write(ostr[i])
    Inc(i)
  wend
  UART1_Write($0A)
end sub'~

'----- Creates new file and writes some data to it
sub procedure Create_New_File

  filename[7] = "A"
  Cf_Fat_Assign(filename, 0xA0)      ' Will not find file and then
create file
  Cf_Fat_Rewrite()                  ' To clear file and start with
new data
  for loop_=1 to 90                  ' We want 5 files on the MMC
card
    PORTC = loop_
    file_contents[0] = loop_ div 10 + 48
    file_contents[1] = loop_ mod 10 + 48
    Cf_Fat_Write(file_contents, 38) ' write data to the assigned file
    UART1_Write(".")
  next loop_
end sub'~

'----- Creates many new files and writes data to them
sub procedure Create_Multiple_Files

  for loop2 = "B" to "Z"
    UART1_Write(loop2) ' this line can slow down the performance
    filename[7] = loop2      ' set filename
    Cf_Fat_Assign(filename, 0xA0) ' find existing file or cre-
ate a new one
    Cf_Fat_Rewrite          ' To clear file and start
with new data
    for loop_ = 1 to 44
      file_contents[0] = loop_ div 10 + 48
      file_contents[1] = loop_ mod 10 + 48
      Cf_Fat_Write(file_contents, 38) ' write data to the assigned
file
    next loop_
  next loop2
end sub'~

'----- Opens an existing file and rewrites it
sub procedure Open_File_Rewrite

```



```

filename[ 7] = "C"           ' Set filename for single-file tests
Cf_Fat_Assign(filename, 0)
Cf_Fat_Rewrite
for loop_ = 1 to 55
    file_contents[ 0] = byte(loop_ div 10 + 48)
    file_contents[ 1] = byte(loop_ mod 10 + 48)
    Cf_Fat_Write(file_contents, 38) ' write data to the assigned file
next loop_
end sub'~

'----- Opens an existing file and appends data to it
'           (and alters the date/time stamp)
sub procedure Open_File_Append
    filename[ 7] = "B"
    Cf_Fat_Assign(filename, 0)
    Cf_Fat_Set_File_Date(2005,6,21,10,35,0)
    Cf_Fat_Append
    file_contents = " for mikroElektronika 2005"           ' Prepare file
for append
    file_contents[ 26] = 10                                 ' LF
    Cf_Fat_Write(file_contents, 27)                         ' Write data
to assigned file
end sub'~

'----- Opens an existing file, reads data from it and puts
it to USART
sub procedure Open_File_Read
    filename[ 7] = "B"
    Cf_Fat_Assign(filename, 0)
    Cf_Fat_Reset(size)           ' To read file, sub procedure returns
size of file
    while size > 0
        Cf_Fat_Read(character)
        UART1_Write(character)           ' Write data to USART
        Dec(size)
    wend
end sub'~

'----- Deletes a file. If file doesn't exist, it will first
be created
'           and then deleted.
sub procedure Delete_File
    filename[ 7] = "F"
    Cf_Fat_Assign(filename, 0)
    Cf_Fat_Delete
end sub'~

'----- Tests whether file exists, and if so sends its cre-
ation date
'           and file size via USART

```

```
sub procedure Test_File_Exist(dim fname as byte)
dim
    fsize as longint
    year as word
    month_, day, hour_, minute_ as byte
    outstr as byte[12]

    filename[7] = "B"          'uncomment this line to search for file
that DOES exists
    ' filename[7] = "F"        'uncomment this line to search for file
that DOES NOT exist
    if Cf_Fat_Assign(filename, 0) <> 0 then
        '--- file has been found - get its date
        Cf_Fat_Get_File_Date(year,month_,day,hour_,minute_)
        WordToStr(year, outstr)
        Write_Str(outstr)
        ByteToStr(month_, outstr)
        Write_Str(outstr)
        WordToStr(day, outstr)
        Write_Str(outstr)
        WordToStr(hour_, outstr)
        Write_Str(outstr)
        WordToStr(minute_, outstr)
        Write_Str(outstr)
        '--- get file size
        fsize = Cf_Fat_Get_File_Size
        LongIntToStr(fsize, outstr)
        Write_Str(outstr)
    else
        '--- file was not found - signal it
        UART1_Write(0x55)
        Delay_ms(1000)
        UART1_Write(0x55)
    end if
end sub'~

'----- Tries to create a swap file, whose size will be at
least 100
'          sectors (see Help for details)
sub procedure M_Create_Swap_File
dim i as word

    for i=0 to 511
        Buffer[i] = i
    next i
    size = Cf_Fat_Get_Swap_File(5000, "mikroE.txt", 0x20) ' see
help on this sub function for details

    if (size <> 0) then
```

```

LongIntToStr(size, fat_txt)
    Write_Str(fat_txt)

    for i=0 to 4999
        Cf_Write_Sector(size, Buffer)
        size = size+1
        UART1_Write(".")
    next i
end if
end sub'~

'----- Main. Uncomment the sub function(s) to test the
desired operation(s)
main:
    FAT_TXT = "FAT16 not found"
    file_contents = "XX CF FAT16 library by Anton Rieckert"
    file_contents[ 37] = 10          ' newline
    filename = "MIKRO00xTXT"

    ' we will use PORTC to signal test end
    DDRC = 0xFF
    PORTC = 0

    UART1_Init(19200)                ' Set up USART for file read-
ing
    delay_ms(100)
    UART1_Write_Text(":Start:")

    ' --- Init the FAT library
    ' --- use Cf_Fat_QuickFormat instead of init routine if a for-
mat is needed
    if Cf_Fat_Init() = 0 then

        '--- test sub functions
        '----- test group #1
        Create_New_File()
        Create_Multiple_Files()
        '----- test group #2
        Open_File_Rewrite()
        Open_File_Append()
        Delete_File
        '----- test group #3
        Open_File_Read()
        Test_File_Exist("F")
        M_Create_Swap_File()
        '--- Test termination
        UART1_Write(0xAA)
    else
        UART1_Write_Text(FAT_TXT)
    end if
    '--- signal end-of-test
    UART1_Write_Text(":End:")
end.'~!

```

HW Connection

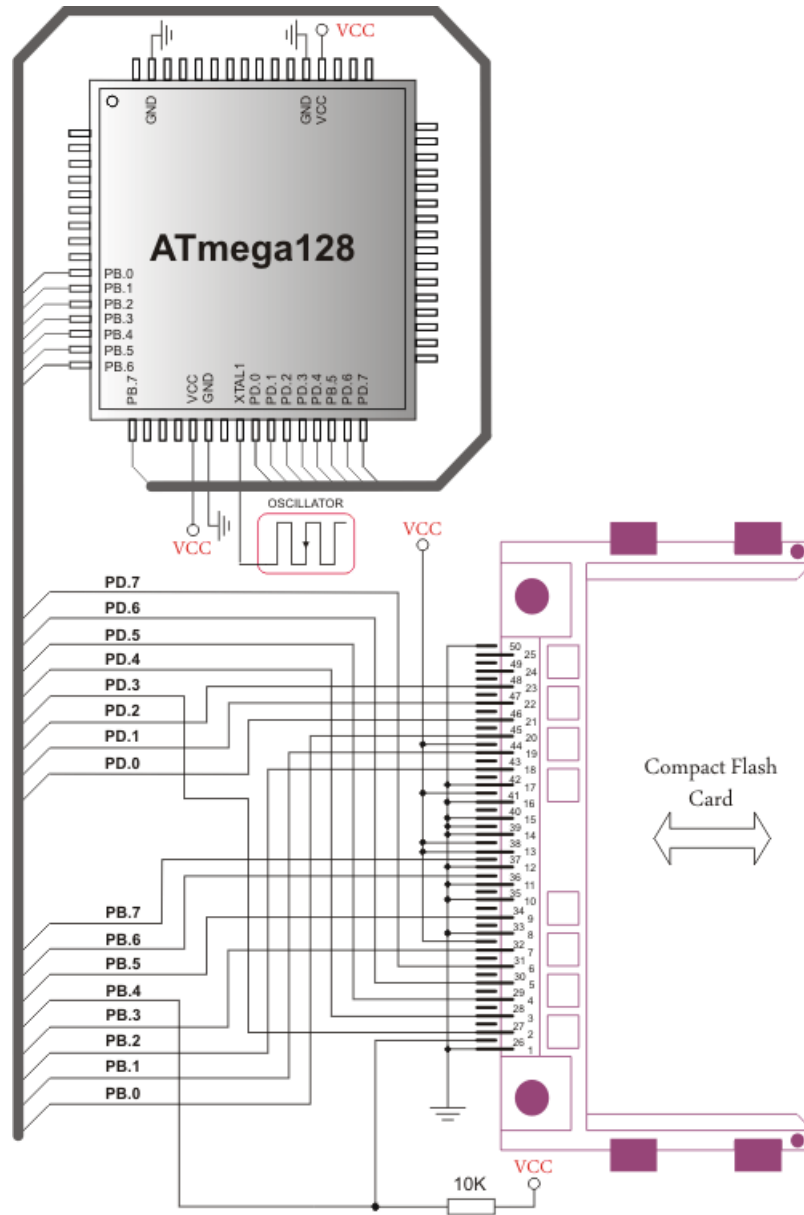

Pin diagram of CF memory card

EEPROM LIBRARY

EEPROM data memory is available with a number of AVR family. The mikroBasic PRO for AVR includes a library for comfortable work with MCU's internal EEPROM.

Note: EEPROM Library functions implementation is MCU dependent, consult the appropriate MCU datasheet for details about available EEPROM size and address range.

Library Routines

- EEPROM_Read
- EEPROM_Write

EEPROM_Read

Prototype	<code>sub function EEPROM_Read(dim address as word) as byte</code>
Returns	Byte from the specified address.
Description	Reads data from specified address. Parameters : - <code>address</code> : address of the EEPROM memory location to be read.
Requires	Nothing.
Example	<pre>dim eeAddr as word temp as byte ... eeAddr = 2 temp = EEPROM_Read(eeAddr)</pre>

EEPROM_Write

Prototype	<code>sub procedure EEPROM_Write(dim address as word, dim wrdata as byte)</code>
Returns	Nothing.
Description	<p>Writes wrdata to specified address.</p> <p>Parameters :</p> <ul style="list-style-type: none">- <code>address</code>: address of the EEPROM memory location to be written.- <code>wrdata</code>: data to be written. <p>Note: Specified memory location will be erased before writing starts.</p>
Requires	Nothing.
Example	<pre>dim eeWrite as byte wrAddr as word ... eeWrite = 0x02 wrAddr = 0xAA EEPROM_Write(wrAddr, eeWrite)</pre>

Library Example

This example demonstrates using the EEPROM Library with ATmega16 MCU.

First, some data is written to EEPROM in byte and block mode; then the data is read from the same locations and displayed on PORTA, PORTB and PORTC.

```

program EEPROM

dim counter as byte                                ' loop variable

main:
  DDRA = 0xFF
  DDRB = 0xFF
  DDRC = 0xFF

  for counter = 0 to 31                               ' Fill data buffer
    EEPROM_Write(0x100 + counter, counter)             ' Write data to
    address 0x100+counter
  next counter

  EEPROM_Write(0x02,0xAA) ' Write some data at address 2
  EEPROM_Write(0x150,0x55) ' Write some data at address 0x150

  Delay_ms(1000)                                       ' Blink PORTA and PORTB diodes
  PORTA = 0xFF                                         '   to indicate reading start
  PORTB = 0xFF
  Delay_ms(1000)
  PORTA = 0x00
  PORTB = 0x00
  Delay_ms(1000)

  PORTA = EEPROM_Read(0x02)                            ' Read data from
  address 2 and display it on PORTA
  PORTB = EEPROM_Read(0x150)                          ' Read data from
  address 0x150 and display it on PORTB

  Delay_ms(1000)

  for counter = 0 to 31 ' Read 32 bytes block from address 0x100
    PORTC = EEPROM_Read(0x100+counter)                 '   and display
  data on PORTC
    Delay_ms(100)
  next counter
end.

```

FLASH MEMORY LIBRARY

This library provides routines for accessing microcontroller Flash memory. Note that prototypes differ for MCU to MCU due to the amount of Flash memory.

Note: Due to the AVR family flash specifics, flash library is MCU dependent. Since some AVR MCU's have more or less than 64kb of Flash memory, prototypes may be different from chip to chip.

Please refer to datasheet before using flash library.

Note: Currently, Write operations are not supported. See mikroBasic PRO for AVR specifics for details.

Library Routines

- FLASH_Read_Byte
- FLASH_Read_Bytes
- FLASH_Read_Word
- FLASH_Read_Words

FLASH_Read_Byte

Prototype	<pre>' for MCUs with 64kb of Flash memory or less sub function FLASH_Read_Byte(dim address as word) as byte ' for MCUs with Flash memory larger than 64kb sub function FLASH_Read_Byte(dim address as longword) as byte</pre>
Returns	Returns data byte from Flash memory.
Description	Reads data from the specified address in Flash memory.
Requires	Nothing.
Example	<pre>' for MCUs with Flash memory larger than 64kb dim tmp as longword ... tmp = Flash_Read(0x0D00) ...</pre>

FLASH_Read_Bytes

Prototype	<pre>' for MCUs with 64kb of Flash memory or less sub procedure FLASH_Read_Bytes(dim address as word, dim buffer as ^byte, dim NoBytes as word) ' for MCUs with Flash memory larger than 64kb sub procedure FLASH_Read_Bytes(dim address as longword, dim buffer as ^byte, dim NoBytes as word)</pre>
Returns	Nothing.
Description	Reads number of data bytes defined by NoBytes parameter from the specified address in Flash memory to variable pointed by buffer.
Requires	Nothing.
Example	<pre>'for MCUs with Flash memory larger than 64kb const F_ADDRESS as longint = 0x200 dim dat_buff[32] as word ... FLASH_Read_Bytes(F_ADDRESS,dat_buff, 64)</pre>

FLASH_Read_Word

Prototype	<pre>' for MCUs with 64kb of Flash memory or less sub function FLASH_Read_Word(dim address as word) as word ' for MCUs with Flash memory larger than 64kb sub function FLASH_Read_Word(dim address as longword) as word</pre>
Returns	Returns data word from Flash memory.
Description	Reads data from the specified address in Flash memory.
Requires	Nothing.
Example	<pre>' for MCUs with Flash memory larger than 64kb dim tmp as longword ... tmp = Flash_Read(0x0D00) ...</pre>

FLASH_Read_Words

Prototype	<pre>' for MCUs with 64kb of Flash memory or less sub procedure FLASH_Read_Words(dim address as word, dim buffer as ^word, dim NoWords as word) ' for MCUs with Flash memory larger than 64kb sub procedure FLASH_Read_Words(dim address as longword, dim buffer as ^word, dim NoWords as word)</pre>
Returns	Nothing.
Description	Reads number of data words defined by <code>NoWords</code> parameter from the specified <code>address</code> in Flash memory to variable pointed by <code>buffer</code> .
Requires	Nothing.
Example	<pre>'for MCUs with Flash memory larger than 64kb const F_ADDRESS as longint = 0x200 dim dat_buff[32] as word ... FLASH_Read_Bytes(F_ADDRESS,dat_buff, 64)</pre>

Library Example

The example demonstrates simple write to the flash memory for AVR, then reads the data and displays it on PORTB and PORTD.

```
program Flash_MCU_test

const F_ADDRESS as longint = 0x200

const data_ as word[ 32] = (
    0x0000,0x0001,0x0002,0x0003,0x0004,0x0005,0x0006,0x0007,
    0x0008,0x0009,0x000A,0x000B,0x000C,0x000D,0x000E,0x000F,
    0x0000,0x0100,0x0200,0x0300,0x0400,0x0500,0x0600,0x0700,
    0x0800,0x0900,0x0A00,0x0B00,0x0C00,0x0D00,0x0E00,0x0F00
) org 0x200

dim counter as byte
word_ as word
dat_buff as word[ 32]
'dat_buff_ as word[ 32]
main:
    DDRD = 0xFF          ' set direction to be output
    DDRB = 0xFF          ' set direction to be output
    word_ = data_[ 0]    ' link const table
```

```

counter = 0
  while ( counter < 64 )           ' reading 64 bytes in loop
    PORTD = FLASH_Read_Byte(F_ADDRESS + counter)   ' demonstration
of reading single byte
    Inc(counter)
    PORTB = FLASH_Read_Byte(F_ADDRESS + counter)   ' demonstration
of reading single byte
    Inc(counter)
    Delay_ms(200)
  wend

FLASH_Read_Bytes(F_ADDRESS, @dat_buff, 64)         ' demonstration
of reading 64 bytes
  for counter = 0 to 31
    PORTD = dat_buff[ counter]   ' output low byte to PORTD
    PORTB = word((dat_buff[ counter] >> 8))       ' output high-
er byte to PORTB
    Delay_ms(200)
  next counter

counter = 0
  while (counter <= 63)           ' reading 32 words in loop
    word_ = FLASH_Read_Word(F_ADDRESS + counter)  ' demonstration
of reading single word
    PORTD = word_                 ' output low byte to PORTD
    PORTB = Hi(word_)' >> 8)     ' output higher byte to PORTB
    counter = counter + 2
    Delay_ms(200)
  wend

FLASH_Read_Words(F_ADDRESS, @dat_buff, 32)        ' demonstration
of reading 64 bytes
  for counter = 0 to 31
    PORTD = dat_buff[ counter]   ' output low byte to PORTD
    PORTB = word((dat_buff[ counter] >> 8))       ' output high-
er byte to PORTB
    Delay_ms(200)
  next counter
end.

```

GRAPHIC LCD LIBRARY

The mikroBasic PRO for AVR provides a library for operating Graphic Lcd 128x64 (with commonly used Samsung KS108/KS107 controller).

For creating a custom set of Glcd images use Glcd Bitmap Editor Tool.

External dependencies of Graphic Lcd Library

The following variables must be defined in all projects using Graphic Lcd Library:	Description:	Example :
<code>dim GLCD_DataPort as byte sfr external</code>	Glcd Data Port.	<code>dim GLCD_DataPort as byte at PORTC</code>
<code>dim GLCD_DataPort_Direction as byte sfr external</code>	Direction of the Glcd Data Port.	<code>dim GLCD_DataPort_Directi on as byte at DDRC</code>
<code>dim GLCD_CS1 as sbit sfr external</code>	Chip Select 1 line.	<code>dim GLCD_CS1 as sbit at PORTD.B2</code>
<code>dim GLCD_CS2 as sbit sfr external</code>	Chip Select 2 line.	<code>dim GLCD_CS2 as sbit at PORTD.B3</code>
<code>dim GLCD_RS as sbit sfr external</code>	Register select line.	<code>dim GLCD_RS as sbit at PORTD.B4</code>
<code>dim GLCD_RW as sbit sfr external</code>	Read/Write line.	<code>dim GLCD_RW as sbit at PORTD.B5</code>
<code>dim GLCD_RST as sbit sfr external</code>	Reset line.	<code>dim GLCD_RST as sbit at PORTD.B6</code>
<code>dim GLCD_EN as sbit sfr external</code>	Enable line.	<code>dim GLCD_EN as sbit at PORTD.B7</code>
<code>dim GLCD_CS1_Direction as sbit sfr external</code>	Direction of the Chip Select 1 pin.	<code>dim GLCD_CS1_Direction as sbit at DDRD.B2</code>
<code>dim GLCD_CS2_Direction as sbit sfr external</code>	Direction of the Chip Select 2 pin.	<code>dim GLCD_CS2_Direction as sbit at DDRD.B3</code>
<code>dim GLCD_RS_Direction as sbit sfr external</code>	Direction of the Register select pin.	<code>dim GLCD_RS_Direction as sbit at DDRD.B4</code>
<code>dim GLCD_RW_Direction as sbit sfr external</code>	Direction of the Read/Write pin.	<code>dim GLCD_RW_Direction as sbit at DDRD.B5</code>
<code>dim GLCD_EN_Direction as sbit sfr external</code>	Direction of the Enable pin.	<code>dim GLCD_EN_Direction as sbit at DDRD.B6</code>
<code>dim GLCD_RST_Direction as sbit sfr external</code>	Direction of the Reset pin.	<code>dim GLCD_RST_Direction as sbit at DDRD.B7</code>

Library Routines

Basic routines:

- Glcd_Init
- Glcd_Set_Side
- Glcd_Set_X
- Glcd_Set_Page
- Glcd_Read_Data
- Glcd_Write_Data

Advanced routines:

- Glcd_Fill
- Glcd_Dot
- Glcd_Line
- Glcd_V_Line
- Glcd_H_Line
- Glcd_Rectangle
- Glcd_Box
- Glcd_Circle
- Glcd_Set_Font
- Glcd_Write_Char
- Glcd_Write_Text
- Glcd_Image

Glcd_Init

Prototype	<code>sub procedure Glcd_Init()</code>
Returns	Nothing.
Description	Initializes the Glcd module. Each of the control lines is both port and pin configurable, while data lines must be on a single port (pins <0:7>).
Requires	<p>Global variables :</p> <ul style="list-style-type: none"> - <code>GLCD_CS1</code> : Chip select 1 signal pin - <code>GLCD_CS2</code> : Chip select 2 signal pin - <code>GLCD_RS</code> : Register select signal pin - <code>GLCD_RW</code> : Read/Write Signal pin - <code>GLCD_EN</code> : Enable signal pin - <code>GLCD_RST</code> : Reset signal pin - <code>GLCD_DataPort</code> : Data port <ul style="list-style-type: none"> - <code>GLCD_CS1_Direction</code> : Direction of the Chip select 1 pin - <code>GLCD_CS2_Direction</code> : Direction of the Chip select 2 pin - <code>GLCD_RS_Direction</code> : Direction of the Register select signal pin - <code>GLCD_RW_Direction</code> : Direction of the Read/Write signal pin - <code>GLCD_EN_Direction</code> : Direction of the Enable signal pin - <code>GLCD_RST_Direction</code> : Direction of the Reset signal pin - <code>GLCD_DataPort_Direction</code> : Direction of the Data port <p>must be defined before using this function.</p>
Example	<pre>// Glcd module connections dim GLCD_DataPort as byte at PORTC GLCD_DataPort_Direction as byte at DDRC dim GLCD_CS1 as sbit at PORTD.B2 GLCD_CS2 as sbit at PORTD.B3 GLCD_RS as sbit at PORTD.B4 GLCD_RW as sbit at PORTD.B5 GLCD_EN as sbit at PORTD.B6 GLCD_RST as sbit at PORTD.B7 dim GLCD_CS1_Direction as sbit at DDRD.B2 GLCD_CS2_Direction as sbit at DDRD.B3 GLCD_RS_Direction as sbit at DDRD.B4 GLCD_RW_Direction as sbit at DDRD.B5 GLCD_EN_Direction as sbit at DDRD.B6 GLCD_RST_Direction as sbit at DDRD.B7 // End Glcd module connections ... Glcd_Init()</pre>

Glcd_Set_Side

Prototype	<code>sub procedure Glcd_Set_Side(dim x_pos as byte)</code>
Returns	Nothing.
Description	<p>Selects Glcd side. Refer to the Glcd datasheet for detailed explanation.</p> <p>Parameters :</p> <p>- <code>x_pos</code>: position on x-axis. Valid values: 0..127</p> <p>The parameter <code>x_pos</code> specifies the Glcd side: values from 0 to 63 specify the left side, values from 64 to 127 specify the right side.</p> <p>Note: For side, x axis and page layout explanation see schematic at the bottom of this page.</p>
Requires	Glcd needs to be initialized, see Glcd_Init routine.
Example	<p>The following two lines are equivalent, and both of them select the left side of Glcd:</p> <pre>Glcd_Select_Side(0) Glcd_Select_Side(10)</pre>

Glcd_Set_X

Prototype	<code>sub procedure Glcd_Set_X(dim x_pos as byte)</code>
Returns	Nothing.
Description	<p>Sets x-axis position to <code>x_pos</code> dots from the left border of Glcd within the selected side.</p> <p>Parameters :</p> <p>- <code>x_pos</code>: position on x-axis. Valid values: 0..63</p> <p>Note: For side, x axis and page layout explanation see schematic at the bottom of this page.</p>
Requires	Glcd needs to be initialized, see Glcd_Init routine.
Example	<code>Glcd_Set_X(25)</code>

Glcd_Set_Page

Prototype	<code>sub procedure Glcd_Set_Page(dim page as byte)</code>
Returns	Nothing.
Description	<p>Selects page of the Glcd.</p> <p>Parameters :</p> <p>- <code>page</code>: page number. Valid values: 0..7</p> <p>Note: For side, x axis and page layout explanation see schematic at the bottom of this page.</p>
Requires	Glcd needs to be initialized, see Glcd_Init routine.
Example	<code>Glcd_Set_Page(5)</code>

Glcd_Read_Data

Prototype	<code>sub function Glcd_Read_Data() as byte</code>
Returns	One byte from Glcd memory.
Description	Reads data from from the current location of Glcd memory and moves to the next location.
Requires	<p>Glcd needs to be initialized, see Glcd_Init routine.</p> <p>Glcd side, x-axis position and page should be set first. See functions Glcd_Set_Side, Glcd_Set_X, and Glcd_Set_Page.</p>
Example	<pre>dim data as byte ... data = Glcd_Read_Data()</pre>

Glcd_Write_Data

Prototype	<code>sub procedure Glcd_Write_Data(dim ddata as byte)</code>
Returns	Nothing.
Description	Writes one byte to the current location in Glcd memory and moves to the next location. Parameters : - <code>ddata</code> : data to be written
Requires	Glcd needs to be initialized, see <code>Glcd_Init</code> routine. Glcd side, x-axis position and page should be set first. See functions <code>Glcd_Set_Side</code> , <code>Glcd_Set_X</code> , and <code>Glcd_Set_Page</code> .
Example	<pre>dim data as byte ... Glcd_Write_Data(data)</pre>

Glcd_Fill

Prototype	<code>sub procedure Glcd_Fill(dim pattern as byte)</code>
Returns	Nothing.
Description	Fills Glcd memory with the byte pattern. Parameters : - <code>pattern</code> : byte to fill Glcd memory with To clear the Glcd screen, use <code>Glcd_Fill(0)</code> . To fill the screen completely, use <code>Glcd_Fill(0xFF)</code> .
Requires	Glcd needs to be initialized, see <code>Glcd_Init</code> routine.
Example	<pre>' Clear screen Glcd_Fill(0)</pre>

Glcd_Dot

Prototype	<code>sub procedure Glcd_Dot(dim x_pos as byte, dim y_pos as byte, dim color as byte)</code>
Returns	Nothing.
Description	<p>Draws a dot on Glcd at coordinates (<code>x_pos</code>, <code>y_pos</code>).</p> <p>Parameters :</p> <ul style="list-style-type: none"> - <code>x_pos</code>: x position. Valid values: 0..127 - <code>y_pos</code>: y position. Valid values: 0..63 - <code>color</code>: color parameter. Valid values: 0..2 <p>The parameter <code>color</code> determines a dot state: 0 clears dot, 1 puts a dot, and 2 inverts dot state.</p> <p>Note: For x and y axis layout explanation see schematic at the bottom of this page.</p>
Requires	Glcd needs to be initialized, see <code>Glcd_Init</code> routine.
Example	<code>' Invert the dot in the upper left corner Glcd_Dot(0, 0, 2)</code>

Glcd_Line

Prototype	<code>sub procedure Glcd_Line(dim x_start as integer, dim y_start as integer, dim x_end as integer, dim y_end as integer, dim color as byte)</code>
Returns	Nothing.
Description	<p>Draws a line on Glcd.</p> <p>Parameters :</p> <ul style="list-style-type: none"> - <code>x_start</code>: x coordinate of the line start. Valid values: 0..127 - <code>y_start</code>: y coordinate of the line start. Valid values: 0..63 - <code>x_end</code>: x coordinate of the line end. Valid values: 0..127 - <code>y_end</code>: y coordinate of the line end. Valid values: 0..63 - <code>color</code>: color parameter. Valid values: 0..2 <p>The parameter <code>color</code> determines the line color: 0 white, 1 black, and 2 inverts each dot.</p>
Requires	Glcd needs to be initialized, see <code>Glcd_Init</code> routine.
Example	<code>' Draw a line between dots (0,0) and (20,30) Glcd_Line(0, 0, 20, 30, 1)</code>

Glcd_V_Line

Prototype	<code>sub procedure Glcd_V_Line(dim y_start as byte, dim y_end as byte, dim x_pos as byte, dim color as byte)</code>
Returns	Nothing.
Description	<p>Draws a vertical line on Glcd.</p> <p>Parameters :</p> <ul style="list-style-type: none"> - <code>y_start</code>: y coordinate of the line start. Valid values: 0..63 - <code>y_end</code>: y coordinate of the line end. Valid values: 0..63 - <code>x_pos</code>: x coordinate of vertical line. Valid values: 0..127 - <code>color</code>: color parameter. Valid values: 0..2 <p>The parameter <code>color</code> determines the line color: 0 white, 1 black, and 2 inverts each dot.</p>
Requires	Glcd needs to be initialized, see Glcd_Init routine.
Example	<code>' Draw a vertical line between dots (10,5) and (10,25)</code> <code>Glcd_V_Line(5, 25, 10, 1)</code>

Glcd_H_Line

Prototype	<code>sub procedure Glcd_V_Line(dim x_start as byte, dim x_end as byte, dim y_pos as byte, dim color as byte)</code>
Returns	Nothing.
Description	<p>Draws a horizontal line on Glcd.</p> <p>Parameters :</p> <ul style="list-style-type: none"> - <code>x_start</code>: x coordinate of the line start. Valid values: 0..127 - <code>x_end</code>: x coordinate of the line end. Valid values: 0..127 - <code>y_pos</code>: y coordinate of horizontal line. Valid values: 0..63 - <code>color</code>: color parameter. Valid values: 0..2 <p>The parameter <code>color</code> determines the line color: 0 white, 1 black, and 2 inverts each dot.</p>
Requires	Glcd needs to be initialized, see Glcd_Init routine.
Example	<code>' Draw a horizontal line between dots (10,20) and (50,20)</code> <code>Glcd_H_Line(10, 50, 20, 1)</code>

Glcd_Rectangle

Prototype	<code>sub procedure Glcd_Rectangle(dim x_upper_left as byte, dim y_upper_left as byte, dim x_bottom_right as byte, dim y_bottom_right as byte, dim color as byte)</code>
Returns	Nothing.
Description	<p>Draws a rectangle on Glcd.</p> <p>Parameters :</p> <ul style="list-style-type: none"> - <code>x_upper_left</code>: x coordinate of the upper left rectangle corner. Valid values: 0..127 - <code>y_upper_left</code>: y coordinate of the upper left rectangle corner. Valid values: 0..63 - <code>x_bottom_right</code>: x coordinate of the lower right rectangle corner. Valid values: 0..127 - <code>y_bottom_right</code>: y coordinate of the lower right rectangle corner. Valid values: 0..63 - <code>color</code>: color parameter. Valid values: 0..2 <p>The parameter <code>color</code> determines the color of the rectangle border: 0 white, 1 black, and 2 inverts each dot.</p>
Requires	Glcd needs to be initialized, see Glcd_Init routine.
Example	<code>' Draw a rectangle between dots (5,5) and (40,40) Glcd_Rectangle(5, 5, 40, 40, 1)</code>

Glcd_Box

Prototype	<code>sub procedure Glcd_Box(dim x_upper_left as byte, dim y_upper_left as byte, dim x_bottom_right as byte, dim y_bottom_right as byte, dim color as byte)</code>
Returns	Nothing.
Description	<p>Draws a box on Glcd.</p> <p>Parameters :</p> <ul style="list-style-type: none"> - <code>x_upper_left</code>: x coordinate of the upper left box corner. Valid values: 0..127 - <code>y_upper_left</code>: y coordinate of the upper left box corner. Valid values: 0..63 - <code>x_bottom_right</code>: x coordinate of the lower right box corner. Valid values: 0..127 - <code>y_bottom_right</code>: y coordinate of the lower right box corner. Valid values: 0..63 - <code>color</code>: color parameter. Valid values: 0..2 <p>The parameter <code>color</code> determines the color of the box fill: 0 white, 1 black, and 2 inverts each dot.</p>
Requires	Glcd needs to be initialized, see Glcd_Init routine.
Example	<code>' Draw a box between dots (5,15) and (20,40) Glcd_Box(5, 15, 20, 40, 1)</code>

Glcd_Circle

Prototype	<code>sub procedure Glcd_Circle(dim x_center as integer, dim y_center as integer, dim radius as integer, dim color as byte)</code>
Returns	Nothing.
Description	<p>Draws a circle on Glcd.</p> <p>Parameters :</p> <ul style="list-style-type: none"> - <code>x_center</code>: x coordinate of the circle center. Valid values: 0..127 - <code>y_center</code>: y coordinate of the circle center. Valid values: 0..63 - <code>radius</code>: radius size - <code>color</code>: color parameter. Valid values: 0..2 <p>The parameter <code>color</code> determines the color of the circle line: 0 white, 1 black, and 2 inverts each dot.</p>
Requires	Glcd needs to be initialized, see Glcd_Init routine.
Example	<code>' Draw a circle with center in (50,50) and radius=10 Glcd_Circle(50, 50, 10, 1)</code>

Glcd_Set_Font

Prototype	<code>sub procedure Glcd_Set_Font(dim byref const ActiveFont as ^byte, dim FontWidth as byte, dim FontHeight as byte, dim FontOffs as word)</code>
Returns	Nothing.
Description	<p>Sets font that will be used with Glcd_Write_Char and Glcd_Write_Text routines.</p> <p>Parameters :</p> <ul style="list-style-type: none"> - <code>activeFont</code>: font to be set. Needs to be formatted as an array of char - <code>aFontWidth</code>: width of the font characters in dots. - <code>aFontHeight</code>: height of the font characters in dots. - <code>aFontOffs</code>: number that represents difference between the mikroBasic PRO for AVR character set and regular ASCII set (eg. if 'A' is 65 in ASCII character, and 'A' is 45 in the mikroBasic PRO for AVR character set, aFontOffs is 20). Demo fonts supplied with the library have an offset of 32, which means that they start with space. <p>The user can use fonts given in the file “__Lib_GLCDFonts.mbas” file located in the Uses folder or create his own fonts.</p>
Requires	Glcd needs to be initialized, see Glcd_Init routine.
Example	<code>' Use the custom 5x7 font "myfont" which starts with space (32): Glcd_Set_Font(myfont, 5, 7, 32)</code>

Glcd_Write_Char

Prototype	<code>sub procedure Glcd_Write_Char(dim chr as byte, dim x_pos as byte, dim page_num as byte, dim color as byte)</code>
Returns	Nothing.
Description	<p>Prints character on the Glcd.</p> <p>Parameters :</p> <ul style="list-style-type: none"> - <code>chr</code>: character to be written - <code>x_pos</code>: character starting position on x-axis. Valid values: 0..(127-FontWidth) - <code>page_num</code>: the number of the page on which character will be written. Valid values: 0..7 - <code>color</code>: color parameter. Valid values: 0..2 <p>The parameter <code>color</code> determines the color of the character: 0 white, 1 black, and 2 inverts each dot.</p> <p>Note: For x axis and page layout explanation see schematic at the bottom of this page.</p>
Requires	Glcd needs to be initialized, see <code>Glcd_Init</code> routine. Use <code>Glcd_Set_Font</code> to specify the font for display; if no font is specified, then default 5x8 font supplied with the library will be used.
Example	<code>' Write character 'C' on the position 10 inside the page 2: Glcd_Write_Char('C', 10, 2, 1)</code>

Glcd_Write_Text

Prototype	<code>sub procedure Glcd_Write_Text(dim byref text as string[20], dim x_pos as byte, dim page_num as byte, dim color as byte)</code>
Returns	Nothing.
Description	<p>Prints text on Glcd.</p> <p>Parameters :</p> <ul style="list-style-type: none"> - <code>text</code>: text to be written - <code>x_pos</code>: text starting position on x-axis. - <code>page_num</code>: the number of the page on which text will be written. Valid values: 0..7 - <code>color</code>: color parameter. Valid values: 0..2 <p>The parameter <code>color</code> determines the color of the text: 0 white, 1 black, and 2 inverts each dot.</p> <p>Note: For x axis and page layout explanation see schematic at the bottom of this page.</p>
Requires	Glcd needs to be initialized, see <code>Glcd_Init</code> routine. Use <code>Glcd_Set_Font</code> to specify the font for display; if no font is specified, then default 5x8 font supplied with the library will be used.
Example	<code>' Write text "Hello world!" on the position 10 inside the page 2: Glcd_Write_Text("Hello world!", 10, 2, 1)</code>

Glcd_Image

Prototype	<code>sub procedure Glcd_Image(dim byref const image as ^byte)</code>
Returns	Nothing.
Description	<p>Displays bitmap on Glcd.</p> <p>Parameters :</p> <ul style="list-style-type: none"> - <code>image</code>: image to be displayed. Bitmap array must be located in code memory. <p>Use the mikroBasic PRO for AVR integrated Glcd Bitmap Editor to convert image to a constant array suitable for displaying on Glcd.</p>
Requires	Glcd needs to be initialized, see <code>Glcd_Init</code> routine.
Example	<code>' Draw image my_image on Glcd Glcd_Image(my_image)</code>

Library Example

The following example demonstrates routines of the Glcd library: initialization, clear(pattern fill), image displaying, drawing lines, circles, boxes and rectangles, text displaying and handling.

```

program Glcd_Test

include bitmap

' Glcd module connections
dim GLCD_DataPort as byte at PORTC
    GLCD_DataPort_Direction as byte at DDRC

dim GLCD_CS1 as sbit at PORTD.B2
    GLCD_CS2 as sbit at PORTD.B3
    GLCD_RS as sbit at PORTD.B4
    GLCD_RW as sbit at PORTD.B5
    GLCD_EN as sbit at PORTD.B6
    GLCD_RST as sbit at PORTD.B7

dim GLCD_CS1_Direction as sbit at DDRD.B2
    GLCD_CS2_Direction as sbit at DDRD.B3
    GLCD_RS_Direction as sbit at DDRD.B4
    GLCD_RW_Direction as sbit at DDRD.B5
    GLCD_EN_Direction as sbit at DDRD.B6
    GLCD_RST_Direction as sbit at DDRD.B7
' End Glcd module connections

dim counter as byte
    someText as char[ 18]

sub procedure Delay2S() ' 2 seconds delay sub
function
    Delay_ms(2000)
end sub

main:
    Glcd_Init() ' Initialize Glcd
    Glcd_Fill(0x00) ' Clear Glcd

    while TRUE
        Glcd_Image(@truck_bmp) ' Draw image
        Delay2S() delay2S()

        Glcd_Fill(0x00) ' Clear Glcd

        Glcd_Box(62, 40, 124, 63, 1) ' Draw box
        Glcd_Rectangle(5, 5, 84, 35, 1) ' Draw rectangle
        Glcd_Line(0, 0, 127, 63, 1) ' Draw line
        Delay2S()
        counter = 5

```

```

while (counter <= 59)      ' Draw horizontal and vertical lines
    Delay_ms(250)
    Glcd_V_Line(2, 54, counter, 1)
    Glcd_H_Line(2, 120, counter, 1)
    Counter = counter + 5
wend

Delay2S()

Glcd_Fill(0x00)                ' Clear Glcd

    Glcd_Set_Font(@Character8x7, 8, 7, 32) ' Choose font
"Character8x7"
    Glcd_Write_Text("mikroE", 1, 7, 2)    ' Write string

for counter = 1 to 10      ' Draw circles
    Glcd_Circle(63,32, 3*counter, 1)
next counter
Delay2S()

Glcd_Box(12,20, 70,57, 2)    ' Draw box
Delay2S()

Glcd_Fill(0xFF)              ' Fill Glcd
Glcd_Set_Font(@Character8x7, 8, 7, 32) ' Change font
someText = "8x7 Font"
Glcd_Write_Text(someText, 5, 0, 2)    ' Write string
delay2S()

Glcd_Set_Font(@System3x6, 3, 5, 32)   ' Change font
someText = "3X5 CAPITALS ONLY"
Glcd_Write_Text(someText, 60, 2, 2)    ' Write string
delay2S()

Glcd_Set_Font(@font5x7, 5, 7, 32)     ' Change font
someText = "5x7 Font"
Glcd_Write_Text(someText, 5, 4, 2)    ' Write string
delay2S()

Glcd_Set_Font(@FontSystem5x7_v2, 5, 7, 32) ' Change font
someText = "5x7 Font (v2)"
Glcd_Write_Text(someText, 5, 6, 2)    ' Write string
delay2S()
wend
end.

```

HW Connection

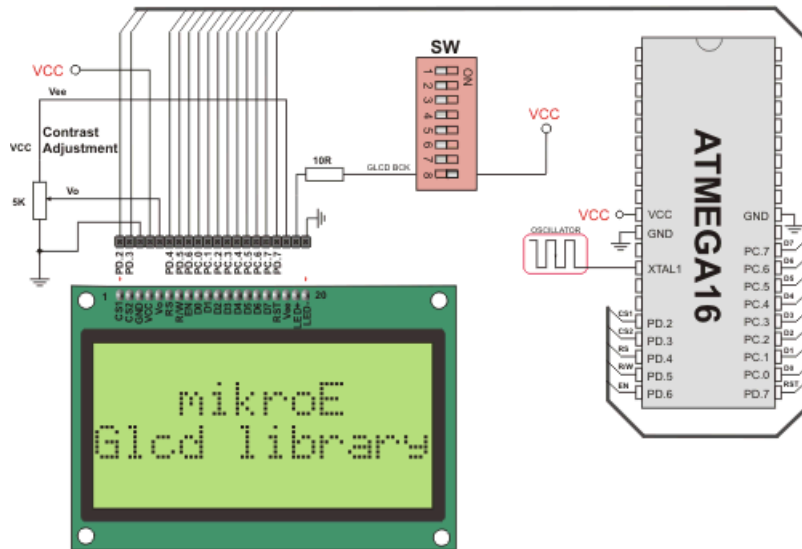
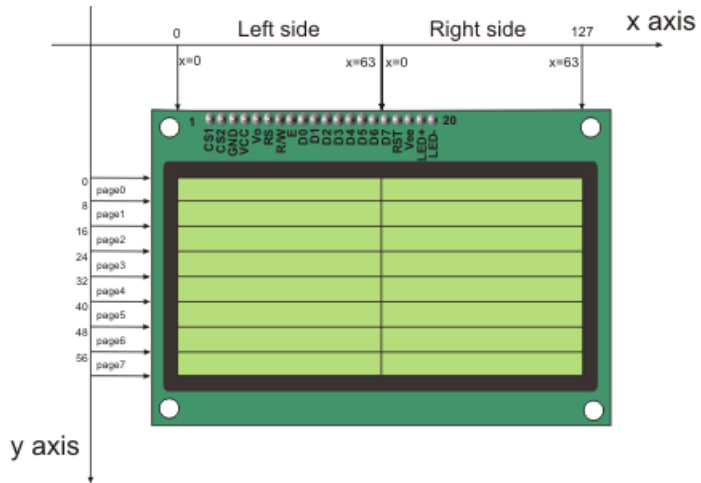

Glcd HW connection

KEYPAD LIBRARY

The mikroBasic PRO for AVR provides a library for working with 4x4 keypad. The library routines can also be used with 4x1, 4x2, or 4x3 keypad. For connections explanation see schematic at the bottom of this page.

Note: Since sampling lines for AVR MCUs are activated by logical zero Keypad Library can not be used with hardwares that have protective diodes connected with anode to MCU side, such as mikroElektronika's Keypad extra board HW.Rev v1.20

The following variable must be defined in all projects using Keypad Library:	Description:	Example :
<code>dim keypadPort as byte sfr external</code>	Keypad Port.	<code>dim keypadPort as byte at PORTB</code>
<code>dim keypadPort_Direction as byte sfr external</code>	Direction of the Keypad Port.	<code>dim keypadPort_Direction as byte at DDRB</code>

Library Routines

- Keypad_Init
- Keypad_Key_Press
- Keypad_Key_Click

Keypad_Init

Prototype	<code>sub procedure Keypad_Init()</code>
Returns	Nothing.
Description	Initializes port for working with keypad.
Requires	Global variables : - <code>keypadPort_Reg</code> - Keypad port - <code>keypadPort_Reg_Direction</code> - Direction of the Keypad port must be defined before using this function.
Example	<pre>' Initialize PORTB for communication with keypad dim keypadPort as byte at PORTB dim keypadPort_Direction as byte at DDRB ... Keypad_Init()</pre>

Keypad_Key_Press

Prototype	<code>sub function Keypad_Key_Press() as byte</code>
Returns	The code of a pressed key (1..16). If no key is pressed, returns 0.
Description	Reads the key from keypad when key gets pressed.
Requires	Port needs to be initialized for working with the Keypad library, see Keypad_Init.
Example	<pre>dim kp as byte ... kp = Keypad_Key_Press()</pre>

Keypad_Key_Click

Prototype	<code>sub function Keypad_Key_Click() as byte</code>
Returns	The code of a clicked key (1..16). If no key is clicked, returns 0.
Description	Call to Keypad_Key_Click is a blocking call: the function waits until some key is pressed and released. When released, the function returns 1 to 16, depending on the key. If more than one key is pressed simultaneously the function will wait until all pressed keys are released. After that the function will return the code of the first pressed key.
Requires	Port needs to be initialized for working with the Keypad library, see Keypad_Init.
Example	<pre>dim kp as byte ... kp = Keypad_Key_Click()</pre>

Library Example

This is a simple example of using the Keypad Library. It supports keypads with 1..4 rows and 1..4 columns. The code being returned by Keypad_Key_Click() function is in range from 1..16. In this example, the code returned is transformed into ASCII codes [0..9,A..F] and displayed on Lcd. In addition, a small single-byte counter displays in the second Lcd row number of key presses.

```
program Keypad_Test
dim kp, cnt, oldstate as byte
    txt as byte[ 7]

' Keypad module connections
dim keypadPort as byte at PORTB
dim keypadPort_Direction as byte at DDRB
' End Keypad module connections

' Lcd pinout definition
dim LCD_RS as sbit at PORTD.2
    LCD_EN as sbit at PORTD.3
    LCD_D4 as sbit at PORTD.4
    LCD_D5 as sbit at PORTD.5
    LCD_D6 as sbit at PORTD.6
    LCD_D7 as sbit at PORTD.7

dim LCD_RS_Direction as sbit at DDRD.2
    LCD_EN_Direction as sbit at DDRD.3
    LCD_D4_Direction as sbit at DDRD.4
    LCD_D5_Direction as sbit at DDRD.5
    LCD_D6_Direction as sbit at DDRD.6
    LCD_D7_Direction as sbit at DDRD.7
' end Lcd pinout definitions

main:
    oldstate = 0
    cnt = 0
    Keypad_Init()
    Lcd_Init()
    Lcd_Cmd(LCD_CLEAR)
    Lcd_Cmd(LCD_CURSOR_OFF)
    Lcd_Out(1, 1, "Key  :")
LCD
    Lcd_Out(2, 1, "Times:")

    while TRUE

        kp = 0
        ' Reset key code variable
        ' Reset counter
        ' Initialize Keypad
        ' Initialize Lcd
        ' Clear display
        ' Cursor off
        ' Write message text on
```

```
' Wait for key to be pressed and released
while ( kp = 0 )
    kp = Keypad_Key_Click()      ' Store key code in kp variable
wend
' Prepare value for output, transform key to it"s ASCII value
select case kp
    'case 10: kp = 42      ' "*"      ' Uncomment this block for keypad4x3
    'case 11: kp = 48      ' "0"
    'case 12: kp = 35      ' "#"
    'default: kp += 48

case 1
    kp = 49      ' 1                ' Uncomment this block for keypad4x4
case 2
    kp = 50      ' 2
case 3
    kp = 51      ' 3
case 4
    kp = 65      ' A
case 5
    kp = 52      ' 4
case 6
    kp = 53      ' 5
case 7
    kp = 54      ' 6
case 8
    kp = 66      ' B
case 9
    kp = 55      ' 7
case 10
    kp = 56      ' 8
case 11
    kp = 57      ' 9
case 12
    kp = 67      ' C
case 13
    kp = 42      ' *
case 14
    kp = 48      ' 0
case 15
    kp = 35      ' #
case 16
    kp = 68      ' D

end select

if (kp <> oldstate) then      ' Pressed key differs from previous
    cnt = 1
    oldstate = kp
```

```
else                                     ' Pressed key is same as previous
    Inc(cnt)
end if
Lcd_Chr(1, 10, kp)                       ' Print key ASCII value on Lcd
if (cnt = 255) then                       ' If counter variable overflow
    cnt = 0
    Lcd_Out(2, 10, "    ")
end if
WordToStr(cnt, txt)                      ' Transform counter value to string
Lcd_Out(2, 10, txt)                      ' Display counter value on Lcd
wend
end.
```

HW Connection

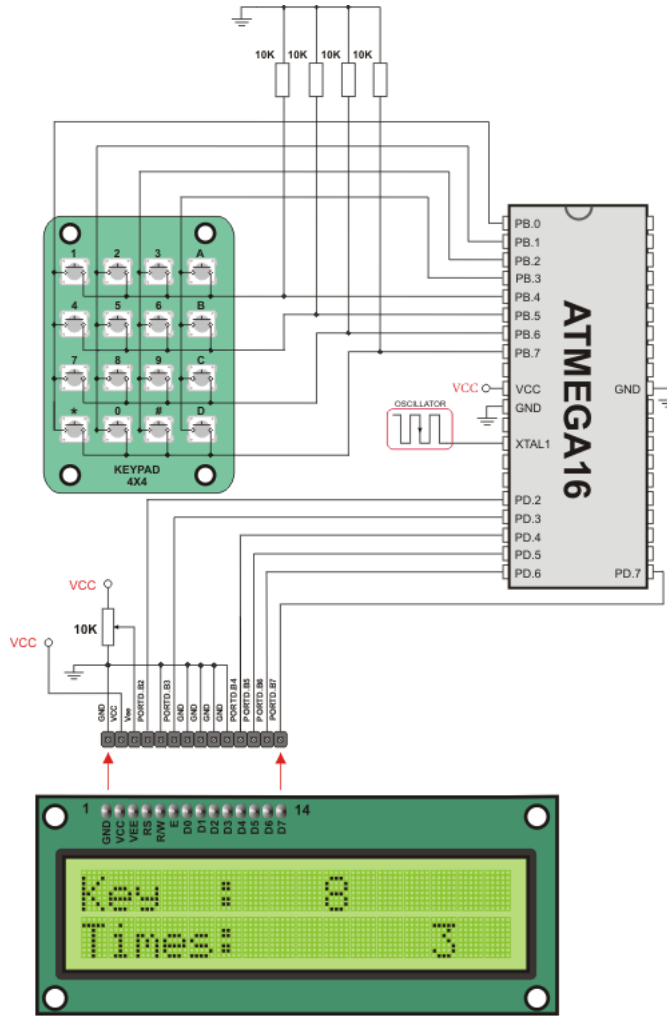

LCD 2X16

4x4 Keypad connection scheme

LCD LIBRARY

The mikroBasic PRO for AVR provides a library for communication with Lcds (with HD44780 compliant controllers) through the 4-bit interface. An example of Lcd connections is given on the schematic at the bottom of this page.

For creating a set of custom Lcd characters use Lcd Custom Character Tool.

External dependencies of Lcd Library

The following variables must be defined in all projects using Lcd Library:	Description:	Example :
<code>dim LCD_RS as sbit sfr external</code>	Register Select line.	<code>dim LCD_RS as sbit at PORTD.B2</code>
<code>dim LCD_EN as sbit sfr external</code>	Enable line.	<code>dim LCD_EN as sbit at PORTD.B3</code>
<code>dim LCD_D7 as sbit sfr external</code>	Data 7 line.	<code>dim LCD_D7 as sbit at PORTD.B4</code>
<code>dim LCD_D6 as sbit sfr external</code>	Data 6 line.	<code>dim LCD_D6 as sbit at PORTD.B5</code>
<code>dim LCD_D5 as sbit sfr external</code>	Data 5 line.	<code>dim LCD_D5 as sbit at PORTD.B6</code>
<code>dim LCD_D4 as sbit sfr external</code>	Data 4 line.	<code>dim LCD_D4 as sbit at PORTD.B7</code>
<code>dim LCD_RS_Direction as sbit sfr external</code>	Register Select direction pin.	<code>dim LCD_RS_Direction as sbit at DDRD.B2</code>
<code>dim LCD_EN_Direction as sbit sfr external</code>	Enable direction pin.	<code>dim LCD_EN_Direction as sbit at DDRD.B3</code>
<code>dim LCD_D7_Direction as sbit sfr external</code>	Data 7 direction pin.	<code>dim LCD_D7_Direction as sbit at DDRD.B4</code>
<code>dim LCD_D6_Direction as sbit sfr external</code>	Data 6 direction pin.	<code>dim LCD_D6_Direction as sbit at DDRD.B5</code>
<code>dim LCD_D5_Direction as sbit sfr external</code>	Data 5 direction pin.	<code>dim LCD_D5_Direction as sbit at DDRD.B6</code>
<code>dim LCD_D4_Direction as sbit sfr external</code>	Data 4 direction pin.	<code>dim LCD_D4_Direction as sbit at DDRD.B7</code>

Library Routines

- Lcd_Init
- Lcd_Out
- Lcd_Out_Cp
- Lcd_Chr
- Lcd_Chr_Cp
- Lcd_Cmd

Lcd_Init

Prototype	<code>sub procedure Lcd_Init()</code>
Returns	Nothing.
Description	Initializes Lcd module.
Requires	<p>Global variables:</p> <ul style="list-style-type: none"> - LCD_D7: Data bit 7 - LCD_D6: Data bit 6 - LCD_D5: Data bit 5 - LCD_D4: Data bit 4 - LCD_RS: Register Select (data/instruction) signal pin - LCD_EN: Enable signal pin <ul style="list-style-type: none"> - LCD_D7_Direction: Direction of the Data 7 pin - LCD_D6_Direction: Direction of the Data 6 pin - LCD_D5_Direction: Direction of the Data 5 pin - LCD_D4_Direction: Direction of the Data 4 pin - LCD_RS_Direction: Direction of the Register Select pin - LCD_EN_Direction: Direction of the Enable signal pin <p>must be defined before using this function.</p>
Example	<pre>' Lcd module connections dim LCD_RS as sbit at PORTD.B2 LCD_EN as sbit at PORTD.B3 LCD_D7 as sbit at PORTD.B4 LCD_D6 as sbit at PORTD.B5 LCD_D5 as sbit at PORTD.B6 LCD_D4 as sbit at PORTD.B7 dim LCD_RS as sbit at DDRD.B2 LCD_EN as sbit at DDRD.B3 LCD_D7 as sbit at DDRD.B4 LCD_D6 as sbit at DDRD.B5 LCD_D5 as sbit at DDRD.B6 LCD_D4 as sbit at DDRD.B7 ' End Lcd module connections ... Lcd_Init()</pre>

Lcd_Out

Prototype	<code>sub procedure Lcd_Out(dim row as byte, dim column as byte, dim byref text as string[20])</code>
Returns	Nothing.
Description	<p>Prints text on Lcd starting from specified position. Both string variables and literals can be passed as a text.</p> <p>Parameters :</p> <ul style="list-style-type: none"> - <code>row</code>: starting position row number - <code>column</code>: starting position column number - <code>text</code>: text to be written
Requires	The Lcd module needs to be initialized. See Lcd_Init routine.
Example	<code>' Write text "Hello!" on Lcd starting from row 1, column 3: Lcd_Out(1, 3, "Hello!")</code>

Lcd_Out_Cp

Prototype	<code>sub procedure Lcd_Out_Cp(dim byref text as string[19])</code>
Returns	Nothing.
Description	<p>Prints text on Lcd at current cursor position. Both string variables and literals can be passed as a text.</p> <p>Parameters :</p> <ul style="list-style-type: none"> - <code>text</code>: text to be written
Requires	The Lcd module needs to be initialized. See Lcd_Init routine.
Example	<code>' Write text "Here!" at current cursor position: Lcd_Out_Cp("Here!")</code>

Lcd_Chr

Prototype	<code>sub procedure Lcd_Chr(dim row as byte, dim column as byte, dim out_char as byte)</code>
Returns	Nothing.
Description	<p>Prints character on Lcd at specified position. Both variables and literals can be passed as a character.</p> <p>Parameters :</p> <ul style="list-style-type: none"> - <code>row</code>: writing position row number - <code>column</code>: writing position column number - <code>out_char</code>: character to be written
Requires	The Lcd module needs to be initialized. See Lcd_Init routine.
Example	<code>' Write character "i" at row 2, column 3: Lcd_Chr(2, 3, 'i')</code>

Lcd_Chr_Cp

Prototype	<code>sub procedure Lcd_Chr_Cp(dim out_char as byte)</code>
Returns	Nothing.
Description	<p>Prints character on Lcd at current cursor position. Both variables and literals can be passed as a character.</p> <p>Parameters :</p> <ul style="list-style-type: none"> - <code>out_char</code>: character to be written
Requires	The Lcd module needs to be initialized. See Lcd_Init routine.
Example	<code>' Write character "e" at current cursor position: Lcd_Chr_Cp('e')</code>

Lcd_Cmd

Prototype	<code>sub procedure Lcd_Cmd(dim out_char as byte)</code>
Returns	Nothing.
Description	<p>Sends command to Lcd.</p> <p>Parameters :</p> <p>- <code>out_char</code>: command to be sent</p> <p>Note: Predefined constants can be passed to the function, see Available SPI Lcd Commands.</p>
Requires	The Lcd module needs to be initialized. See Lcd_Init table.
Example	<pre>' Clear Lcd display: Lcd_Cmd(LCD_CLEAR)</pre>

Available Lcd Commands

Lcd Command	Purpose
<code>LCD_FIRST_ROW</code>	Move cursor to the 1st row
<code>LCD_SECOND_ROW</code>	Move cursor to the 2nd row
<code>LCD_THIRD_ROW</code>	Move cursor to the 3rd row
<code>LCD_FOURTH_ROW</code>	Move cursor to the 4th row
<code>LCD_CLEAR</code>	Clear display
<code>LCD_RETURN_HOME</code>	Return cursor to home position, returns a shifted display to its original position. Display data RAM is unaffected.
<code>LCD_CURSOR_OFF</code>	Turn off cursor
<code>LCD_UNDERLINE_ON</code>	Underline cursor on
<code>LCD_BLINK_CURSOR_ON</code>	Blink cursor on
<code>LCD_MOVE_CURSOR_LEFT</code>	Move cursor left without changing display data RAM
<code>LCD_MOVE_CURSOR_RIGHT</code>	Move cursor right without changing display data RAM
<code>LCD_TURN_ON</code>	Turn Lcd display on
<code>LCD_TURN_OFF</code>	Turn Lcd display off
<code>LCD_SHIFT_LEFT</code>	Shift display left without changing display data RAM
<code>LCD_SHIFT_RIGHT</code>	Shift display right without changing display data RAM

Library Example

The following code demonstrates usage of the Lcd Library routines:

```
' LCD module connections
dim LCD_RS as sbit at PORTD.2
dim LCD_EN as sbit at PORTD.3
dim LCD_D4 as sbit at PORTD.4
dim LCD_D5 as sbit at PORTD.5
dim LCD_D6 as sbit at PORTD.6
dim LCD_D7 as sbit at PORTD.7

dim LCD_RS_Direction as sbit at DDRD.B2
dim LCD_EN_Direction as sbit at DDRD.B3
dim LCD_D4_Direction as sbit at DDRD.B4
dim LCD_D5_Direction as sbit at DDRD.B5
dim LCD_D6_Direction as sbit at DDRD.B6
dim LCD_D7_Direction as sbit at DDRD.B7
' End Lcd module connections

dim txt1 as char[ 17]
    txt2 as char[ 10]
    txt3 as char[ 9]
    txt4 as char[ 8]
    i as byte          ' Loop variable

sub procedure Move_Delay() ' Function used for text moving
    Delay_ms(500)         ' You can change the moving speed here
end sub

main:
    txt1 = "mikroElektronika"
    txt2 = "EasyAVR5A"
    txt3 = "Lcd4bit"
    txt4 = "example"
    Lcd_Init()           ' Initialize Lcd
    Lcd_Cmd(LCD_CLEAR)  ' Clear display
    Lcd_Cmd(LCD_CURSOR_OFF) ' Cursor off
    LCD_Out(1,6,txt3)    ' Write text in first row
    LCD_Out(2,6,txt4)    ' Write text in second row
    Delay_ms(2000)
    Lcd_Cmd(LCD_CLEAR)  ' Clear display

    LCD_Out(1,1,txt1)    ' Write text in first row
    LCD_Out(2,4,txt2)    ' Write text in second row
    Delay_ms(500)

    ' Moving text
    for i=0 to 3         ' Move text to the right 4 times
```

```

Lcd_Cmd(LCD_SHIFT_RIGHT)
  Move_Delay()
next i

while TRUE                                ' Endless loop
  for i=0 to 6                              ' Move text to the left 7 times
    Lcd_Cmd(LCD_SHIFT_LEFT)
    Move_Delay()
  next i
  for i=0 to 6                              ' Move text to the right 7 times
    Lcd_Cmd(LCD_SHIFT_RIGHT)
    Move_Delay()
  next i
wend
end.

```

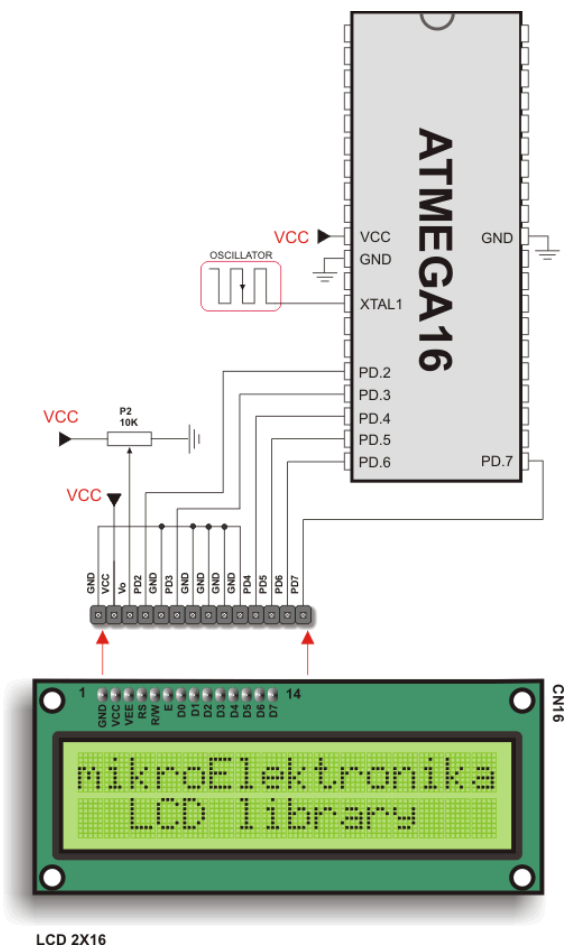

Lcd HW connection

MANCHESTER CODE LIBRARY

The mikroBasic PRO for AVR provides a library for handling Manchester coded signals. The Manchester code is a code in which data and clock signals are combined to form a single self-synchronizing data stream; each encoded bit contains a transition at the midpoint of a bit period, the direction of transition determines whether the bit is 0 or 1; the second half is the true bit value and the first half is the complement of the true bit value (as shown in the figure below).

Manchester RF_Send_Byte format

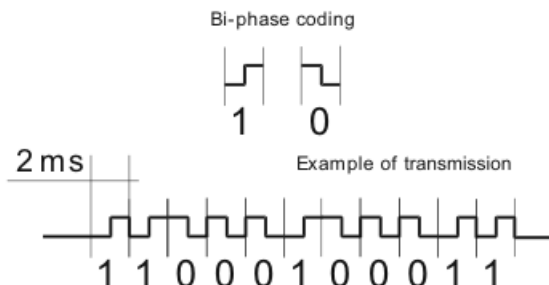
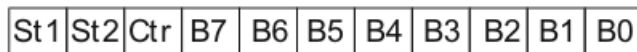

Notes: The Manchester receive routines are blocking calls ([Man_Receive_Init](#) and [Man_Synchro](#)). This means that MCU will wait until the task has been performed (e.g. byte is received, synchronization achieved, etc).

Note: Manchester code library implements time-based activities, so interrupts need to be disabled when using it.

External dependencies of Manchester Code Library

The following variables must be defined in all projects using Manchester Code Library:	Description:	Example :
<code>dim MANRXPIN as sbit</code> <code>sfr external</code>	Receive line.	<code>dim MANRXPIN as sbit</code> <code>at PINB.B0</code>
<code>dim MANTXPIN as sbit</code> <code>sfr external</code>	Transmit line.	<code>dim MANTXPIN as sbit</code> <code>at PORTB.B1</code>
<code>dim</code> <code>MANRXPIN_Direction as</code> <code>sbit sfr external</code>	Direction of the Receive pin.	<code>dim</code> <code>MANRXPIN_Direction as</code> <code>sbit at DDRB.B0</code>
<code>dim</code> <code>MANTXPIN_Direction as</code> <code>sbit sfr external</code>	Direction of the Transmit pin.	<code>dim</code> <code>MANTXPIN_Direction as</code> <code>sbit at DDRB.B1</code>

Library Routines

- Man_Receive_Init
- Man_Receive
- Man_Send_Init
- Man_Send
- Man_Synchro
- Man_Break

The following routines are for the internal use by compiler only:

- Manchester_0
- Manchester_1
- Manchester_Out

Man_Receive_Init

Prototype	<code>sub function Man_Receive_Init() as word</code>
Returns	<ul style="list-style-type: none"> - 0 - if initialization and synchronization were successful. - 1 - upon unsuccessful synchronization.
Description	<p>The function configures Receiver pin and performs synchronization procedure in order to retrieve baud rate out of the incoming signal.</p> <p>Note: In case of multiple persistent errors on reception, the user should call this routine once again or Man_Synchro routine to enable synchronization.</p>
Requires	<p>Global variables :</p> <ul style="list-style-type: none"> - <code>MANRXPIN</code> : Receive line - <code>MANRXPIN_Direction</code> : Direction of the receive pin <p>must be defined before using this function.</p>
Example	<pre>' Initialize Receiver dim MANRXPIN as sbit at PINB.B0 dim MANRXPIN_Direction as sbit at DDRB.B0 ... Man_Receive_Init()</pre>

Man_Receive

Prototype	<code>sub function Man_Receive(dim byreferror as byte) as byte</code>
Returns	A byte read from the incoming signal.
Description	The function extracts one byte from incoming signal. Parameters : - <code>error</code> : error flag. If signal format does not match the expected, the error flag will be set to non-zero.
Requires	To use this function, the user must prepare the MCU for receiving. See <code>Man_Receive_Init</code> .
Example	<pre>dim data, error as byte ... data = 0 error = 0 data = Man_Receive(&error) if (error <> 0) then ' error handling end if</pre>

Man_Send_Init

Prototype	<code>sub procedure Man_Send_Init()</code>
Returns	Nothing.
Description	The function configures Transmitter pin.
Requires	Global variables : - <code>MANRXPIN</code> : Receive line - <code>MANRXPIN_Direction</code> : Direction of the receive pin must be defined before using this function.
Example	<pre>' Initialize Transmitter: dim MANTXPIN as sbit at PINB.B1 dim MANTXPIN_Direction as sbit at DDRB.B1 ... Man_Send_Init()</pre>

Man_Send

Prototype	<code>sub procedure Man_Send(tr_data as byte)</code>
Returns	Nothing.
Description	<p>Sends one byte.</p> <p>Parameters :</p> <ul style="list-style-type: none"> - <code>tr_data</code>: data to be sent <p>Note: Baud rate used is 500 bps.</p>
Requires	To use this function, the user must prepare the MCU for sending. See <code>Man_Send_Init</code> .
Example	<pre>dim msg as byte ... Man_Send(msg)</pre>

Man_Synchro

Prototype	<code>sub function Man_Synchro() as word</code>
Returns	<ul style="list-style-type: none"> - 0 - if synchronization was not successful. - Half of the manchester bit length, given in multiples of 10us - upon successful synchronization.
Description	Measures half of the manchester bit length with 10us resolution.
Requires	To use this function, you must first prepare the MCU for receiving. See <code>Man_Receive_Init</code> .
Example	<pre>dim man_half_bit_len as word ... man_half_bit_len = Man_Synchro()</pre>

Man_Break

Prototype	<code>sub procedure Man_Break()</code>
Returns	Nothing.
Description	<p>Man_Receive is blocking routine and it can block the program flow. Call this routine from interrupt to unblock the program execution. This mechanism is similar to WDT.</p> <p>Note: Interrupts should be disabled before using Manchester routines again (see note at the top of this page).</p>
Requires	Nothing.
Example	<pre> dim data1, error, counter as byte sub procedure Timer0Overflow_ISR org 0x12 counter = 0 if (counter >= 20) then Man_Break() counter = 0 ' reset counter else Inc(counter) ' increment counter end if end sub main: TOIE0_bit = 1 ' Timer0 overflow interrupt enable TCCR0_bit = 5 ' Start timer with 1024 prescaler SREG_I_bit = 0 ' Interrupt disable ... Man_Receive_Init() ... ' try Man_Receive with blocking prevention mechanism SREG_I_bit = 1 ' Interrupt enable data1 = Man_Receive(@error); SREG_I_bit = 0 ' Interrupt disable ... end. </pre>

Library Example

The following code is code for the Manchester receiver, it shows how to use the Manchester Library for receiving data:

```
program Manchester_Receiver
' Lcd module connections
dim LCD_RS as sbit at PORTD.B2
    LCD_EN as sbit at PORTD.B3
    LCD_D4 as sbit at PORTD.B4
    LCD_D5 as sbit at PORTD.B5
    LCD_D6 as sbit at PORTD.B6
    LCD_D7 as sbit at PORTD.B7

dim LCD_RS_Direction as sbit at DDRD.B2
    LCD_EN_Direction as sbit at DDRD.B3
    LCD_D4_Direction as sbit at DDRD.B4
    LCD_D5_Direction as sbit at DDRD.B5
    LCD_D6_Direction as sbit at DDRD.B6
    LCD_D7_Direction as sbit at DDRD.B7
' End Lcd module connections

' Manchester module connections
dim MANRXPIN as sbit at PINB.B0
    MANRXPIN_Direction as sbit at DDRB.B0
    MANTXPIN as sbit at PORTB.B1
    MANTXPIN_Direction as sbit at DDRB.B1
' End Manchester module connections

dim error_, ErrorCount, temp as byte

main:
    ErrorCount = 0
    Delay_10us()
    Lcd_Init() ' Initialize Lcd
    Lcd_Cmd(LCD_CLEAR) ' Clear Lcd display

    Man_Receive_Init() ' Initialize Receiver

    while TRUE ' Endless loop
        Lcd_Cmd(LCD_FIRST_ROW) ' Move cursor to the 1st row
        while TRUE ' Wait for the "start" byte
            temp = Man_Receive(error_) ' Attempt byte receive
            if (temp = 0x0B) then ' "Start" byte, see Transmitter example
                break ' We got the starting sequence
            end if
            if (error_ <> 0) then ' Exit so we do not loop forever
                break
            end if
        wend
```

```

while (temp <> 0x0E)
  temp = Man_Receive(error_)           ' Attempt byte receive
  if (error_ <> 0) then                 ' If error occurred
    Lcd_Chr_CP("?")                    ' Write question mark on Lcd
    Inc(ErrorCount)                    ' Update error counter
    if (ErrorCount > 20) then          ' In case of multiple errors
      temp = Man_Synchro()             ' Try to synchronize again
      'Man_Receive_Init()              ' Alternative, try to Initialize
Receiver again
      ErrorCount = 0                   ' Reset error counter
    end if
  else                                   ' No error occurred
    if (temp <> 0x0E) then              ' If "End" byte was received(see
Transmitter example)
      Lcd_Chr_CP(temp)                 ' do not write received byte on Lcd
    end if
    Delay_ms(25)
  end if

wend                                     ' If "End" byte was received exit do loop
wend
end.

```

The following code is code for the Manchester transmitter, it shows how to use the Manchester Library for transmitting data:

```

program Manchester_Transmitter

' Manchester module connections
dim MANRXPIN as sbit at PORTB.B0
  MANRXPIN_Direction as sbit at DDRB.B0
  MANTXPIN as sbit at PORTB.B1
  MANTXPIN_Direction as sbit at DDRB.B1
' End Manchester module connections

dim index, character as byte
  s1 as char[ 17]

main:
  s1 = "mikroElektronika"
  Man_Send_Init()                       ' Initialize transmitter

  while TRUE                             ' Endless loop
    Man_Send(0x0B)                       ' Send "start" byte
    Delay_ms(100)                         ' Wait for a while
    character = s1[ 0]                   ' Take first char from string
    index = 0                             ' Initialize index variable
  end while

```

```

while (character <> 0)      ' String ends with zero
Man_Send(character)      ' Send character
Delay_ms(90)              ' Wait for a while
Inc(index)                 ' Increment index variable
character = s1[index]     ' Take next char from string
wend
Man_Send(0x0E)            ' Send "end" byte
Delay_ms(1000)
wend
end.

```

Connection Example

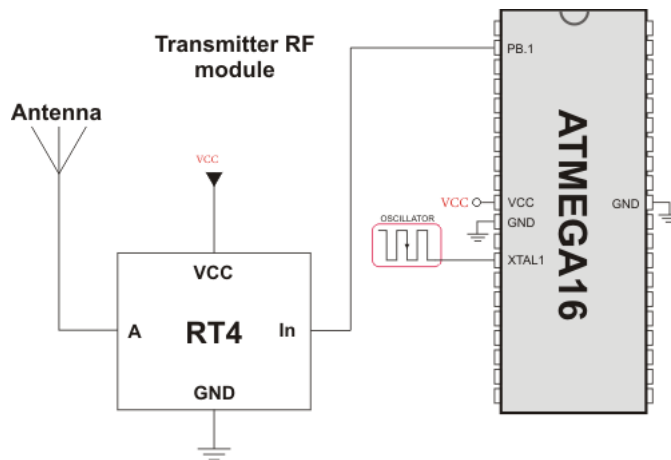

Simple Transmitter connection

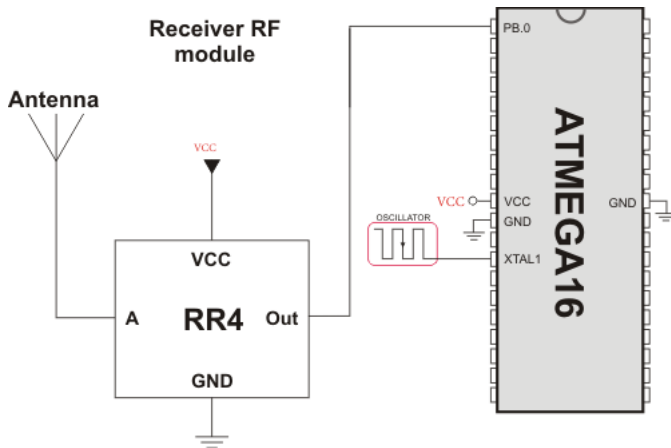

Simple Receiver connection

MULTI MEDIA CARD LIBRARY

The Multi Media Card (MMC) is a flash memory card standard. MMC cards are currently available in sizes up to and including 1 GB, and are used in cell phones, mp3 players, digital cameras, and PDA's.

mikroBasic PRO for AVR provides a library for accessing data on Multi Media Card via SPI communication. This library also supports SD(Secure Digital) memory cards.

Secure Digital Card

Secure Digital (SD) is a flash memory card standard, based on the older Multi Media Card (MMC) format.

SD cards are currently available in sizes of up to and including 2 GB, and are used in cell phones, mp3 players, digital cameras, and PDAs.

Notes:

- Routines for file handling can be used only with FAT16 file system.
- Library functions create and read files from the root directory only;
- Library functions populate both FAT1 and FAT2 tables when writing to files, but the file data is being read from the FAT1 table only; i.e. there is no recovery if FAT1 table is corrupted.
- Prior to calling any of this library routines, Spi_Rd_Ptr needs to be initialized with the appropriate SPI_Read routine.

External dependencies of MMC Library

The following variable must be defined in all projects using MMC library:	Description:	Example :
<code>dim Mmc_Chip_Select as sbit sfr external</code>	Chip select pin.	<code>dim Mmc_Chip_Select as sbit at PINB.B0</code>
<code>dim Mmc_Chip_Select_Direction as sbit sfr external</code>	Direction of the chip select pin.	<code>dim Mmc_Chip_Select_Direction as sbit at DDRB.B0</code>

Library Routines

- Mmc_Init
- Mmc_Read_Sector
- Mmc_Write_Sector
- Mmc_Read_Cid
- Mmc_Read_Csd

Routines for file handling:

- Mmc_Fat_Init
- Mmc_Fat_QuickFormat
- Mmc_Fat_Assign
- Mmc_Fat_Reset
- Mmc_Fat_Read
- Mmc_Fat_Rewrite
- Mmc_Fat_Append
- Mmc_Fat_Delete
- Mmc_Fat_Write
- Mmc_Fat_Set_File_Date
- Mmc_Fat_Get_File_Date
- Mmc_Fat_Get_File_Size
- Mmc_Fat_Get_Swap_File

Mmc_Init

Prototype	<code>sub function Mmc_Init() as byte</code>
Returns	<ul style="list-style-type: none"> - 0 - if MMC/SD card was detected and successfully initialized - 1 - otherwise
Description	<p>Initializes MMC through hardware SPI interface.</p> <p>Parameters:</p> <ul style="list-style-type: none"> - <code>port</code>: chip select signal port address. - <code>cspin</code>: chip select pin.
Requires	<p>Global variables :</p> <ul style="list-style-type: none"> - <code>Mmc_Chip_Select</code>: Chip Select line - <code>Mmc_Chip_Select_Direction</code>: Direction of the Chip Select pin <p>must be defined before using this function. The appropriate hardware SPI module must be previously initialized. See the <code>SPI1_Init</code>, <code>SPI1_Init_Advanced</code> routines.</p>
Example	<pre>' MMC module connections dim Mmc_Chip_Select as sbit sfr at PORTB.B2 dim Mmc_Chip_Select_Direction as sbit sfr at DDRB.B2 ' MMC module connections error = Mmc_Init() ' Init with CS line at PORTB.B2 dim i as byte ... SPI1_Init_Advanced(_SPI_MASTER, _SPI_FCY_DIV2, _SPI_CLK_LO_LEADING) Spi_Rd_Ptr = @SPI1_Read // Pass pointer to SPI Read function of used SPI module i = Mmc_Init()</pre>

Mmc_Read_Sector

Prototype	<code>sub function Mmc_Read_Sector(dim sector as longint, dim byref data as byte[512]) as byte</code>
Returns	<ul style="list-style-type: none"> - 0 - if reading was successful - 1 - if an error occurred
Description	<p>The function reads one sector (512 bytes) from MMC card.</p> <p>Parameters:</p> <ul style="list-style-type: none"> - <code>sector</code>: MMC/SD card sector to be read. - <code>dbuff</code>: buffer of minimum 512 bytes in length for data storage.
Requires	MMC/SD card must be initialized. See <code>Mmc_Init</code> .
Example	<pre>' read sector 510 of the MMC/SD card dim error as word sectorNo as longword dataBuffer as char[512] ... main: ... sectorNo = 510 error = Mmc_Read_Sector(sectorNo, dataBuffer) ... end.</pre>

Mmc_Write_Sector

Prototype	<code>sub function Mmc_Write_Sector(dim sector as longint, dim byref data_ as byte[512]) as byte</code>
Returns	<ul style="list-style-type: none"> - 0 - if writing was successful - 1 - if there was an error in sending write command - 2 - if there was an error in writing (data rejected)
Description	<p>The function writes 512 bytes of data to one MMC card sector.</p> <p>Parameters:</p> <ul style="list-style-type: none"> - <code>sector</code>: MMC/SD card sector to be written to. - <code>dbuffer</code>: data to be written (buffer of minimum 512 bytes in length).
Requires	MMC/SD card must be initialized. See <code>Mmc_Init</code> .
Example	<pre>' write to sector 510 of the MMC/SD card dim error as word sectorNo as longword dataBuffer as char[512] ... main: ... sectorNo = 510 error = Mmc_Write_Sector(sectorNo, dataBuffer) ... end.</pre>

Mmc_Read_Cid

Prototype	<code>sub function Mmc_Read_Cid(dim byref data_cid as byte[16]) as byte</code>
Returns	<ul style="list-style-type: none"> - 0 - if CID register was read successfully - 1 - if there was an error while reading
Description	<p>The function reads 16-byte CID register.</p> <p>Parameters:</p> <ul style="list-style-type: none"> - <code>data_cid</code>: buffer of minimum 16 bytes in length for storing CID register content.
Requires	MMC/SD card must be initialized. See <code>Mmc_Init</code> .
Example	<pre>dim error as word dataBuffer as byte[16] ... main: ... error = Mmc_Read_Cid(dataBuffer) ... end.</pre>

Mmc_Read_Csd

Prototype	<code>sub function Mmc_Read_Csd(dim byref data_for_registers as byte[16]) as byte</code>
Returns	<ul style="list-style-type: none"> - 0 - if CSD register was read successfully - 1 - if there was an error while reading
Description	<p>The function reads 16-byte CSD register.</p> <p>Parameters:</p> <ul style="list-style-type: none"> - <code>data_csd</code>: buffer of minimum 16 bytes in length for storing CSD register content.
Requires	MMC/SD card must be initialized. See <code>Mmc_Init</code> .
Example	<pre>dim error as word dataBuffer as char[16] ... main: ... error = Mmc_Read_Csd(dataBuffer) ... end.</pre>

Mmc_Fat_Init

Prototype	<code>sub function Mmc_Fat_Init() as byte</code>
Returns	<ul style="list-style-type: none">- 0 - if MMC/SD card was detected and successfully initialized- 1 - if FAT16 boot sector was not found- 255 - if MMC/SD card was not detected
Description	<p>Initializes MMC/SD card, reads MMC/SD FAT16 boot sector and extracts necessary data needed by the library.</p> <p>Note: MMC/SD card has to be formatted to FAT16 file system.</p>
Requires	<ul style="list-style-type: none">- <code>Mmc_Chip_Select</code>: Chip Select line- <code>Mmc_Chip_Select_Direction</code>: Direction of the Chip Select pin <p>must be defined before using this function. The appropriate hardware SPI module must be previously initialized. See the <code>SPI1_Init</code>, <code>SPI1_Init_Advanced</code> routines.</p>
Example	<pre>' init the FAT library if (Mmc_Fat_Init() = 0) then ... end if</pre>

Mmc_Fat_QuickFormat

Prototype	<code>sub function Mmc_Fat_QuickFormat (dim mmc_fat_label as string[11]) as byte</code>
Returns	<ul style="list-style-type: none"> - 0 - if MMC/SD card was detected, successfully formatted and initialized - 1 - if FAT16 format was unseccessful - 255 - if MMC/SD card was not detected
Description	<p>Formats to FAT16 and initializes MMC/SD card.</p> <p>Parameters:</p> <ul style="list-style-type: none"> - <code>mmc_fat_label</code>: volume label (11 characters in length). If less than 11 characters are provided, the label will be padded with spaces. If null string is passed volume will not be labeled <p>Note: This routine can be used instead or in conjunction with <code>Mmc_Fat_Init</code> routine.</p> <p>Note: If MMC/SD card already contains a valid boot sector, it will remain unchanged (except volume label field) and only FAT and ROOT tables will be erased. Also, the new volume label will be set.</p>
Requires	The appropriate hardware SPI module must be previously initialized.
Example	<pre>' format and initialize the FAT library if (Mmc_Fat_QuickFormat('mikroE') = 0) then ... end if</pre>

Mmc_Fat_Assign

Prototype	<code>sub function Mmc_Fat_Assign(dim byref filename as char[12], dim file_cre_attr as byte) d</code>																											
Returns	<ul style="list-style-type: none"> - 1 - if file already exists or file does not exist but a new file is created. - 0 - if file does not exist and no new file is created. 																											
Description	<p>Assigns file for file operations (read, write, delete...). All subsequent file operations will be applied on an assigned file.</p> <p>Parameters:</p> <ul style="list-style-type: none"> - <code>filename</code>: name of the file that should be assigned for file operations. File name should be in DOS 8.3 (file_name.extension) format. The file name and extension will be automatically padded with spaces by the library if they have less than length required (i.e. "mikro.tx" -> "mikro .tx "), so the user does not have to take care of that. The file name and extension are case insensitive. The library will convert them to proper case automatically, so the user does not have to take care of that. Also, in order to keep backward compatibility with the first version of this library, file names can be entered as UPPERCASE string of 11 bytes in length with no dot character between file name and extension (i.e. "MIKROELETXT" -> MIKROELE.TXT). In this case last 3 characters of the string are considered to be file extension. - <code>file_cre_attr</code>: file creation and attributs flags. Each bit corresponds to the appropriate file attribut: <table border="1" style="width: 100%; border-collapse: collapse;"> <thead> <tr> <th style="width: 10%;">Bit</th> <th style="width: 15%;">Mask</th> <th style="width: 75%;">Description</th> </tr> </thead> <tbody> <tr> <td>0</td> <td>0x01</td> <td>Read Only</td> </tr> <tr> <td>1</td> <td>0x02</td> <td>Hidden</td> </tr> <tr> <td>2</td> <td>0x04</td> <td>System</td> </tr> <tr> <td>3</td> <td>0x08</td> <td>Volume Label</td> </tr> <tr> <td>4</td> <td>0x10</td> <td>Subdirectory</td> </tr> <tr> <td>5</td> <td>0x20</td> <td>Archive</td> </tr> <tr> <td>6</td> <td>0x40</td> <td>Device (internal use only, never found on disk)</td> </tr> <tr> <td>7</td> <td>0x80</td> <td>File creation flag. If the file does not exist and this flag is set, a new file with specified name will be created.</td> </tr> </tbody> </table> <p>Note: Long File Names (LFN) are not supported.</p>	Bit	Mask	Description	0	0x01	Read Only	1	0x02	Hidden	2	0x04	System	3	0x08	Volume Label	4	0x10	Subdirectory	5	0x20	Archive	6	0x40	Device (internal use only, never found on disk)	7	0x80	File creation flag. If the file does not exist and this flag is set, a new file with specified name will be created.
Bit	Mask	Description																										
0	0x01	Read Only																										
1	0x02	Hidden																										
2	0x04	System																										
3	0x08	Volume Label																										
4	0x10	Subdirectory																										
5	0x20	Archive																										
6	0x40	Device (internal use only, never found on disk)																										
7	0x80	File creation flag. If the file does not exist and this flag is set, a new file with specified name will be created.																										
Requires	MMC/SD card and MMC library must be initialized for file operations. See <code>Mmc_Fat_Init</code> .																											
Example	<code>' create file with archive attribut if it does not already exist Mmc_Fat_Assign("MIKRO007.TXT", 0xA0)</code>																											

Mmc_Fat_Reset

Prototype	<code>sub procedure Mmc_Fat_Reset (dim byref size as longword)</code>
Returns	Nothing.
Description	<p>Opens currently assigned file for reading.</p> <p>Parameters:</p> <ul style="list-style-type: none"> - <code>size</code>: buffer to store file size to. After file has been open for reading its size is returned through this parameter.
Requires	<p>MMC/SD card and MMC library must be initialized for file operations. See <code>Mmc_Fat_Init</code>.</p> <p>The file must be previously assigned. See <code>Mmc_Fat_Assign</code>.</p>
Example	<pre>dim size as longword ... main: ... Mmc_Fat_Reset (size) ... end.</pre>

Mmc_Fat_Read

Prototype	<code>sub procedure Mmc_Fat_Read(dim byref bdata as byte)</code>
Returns	Nothing.
Description	<p>Reads a byte from the currently assigned file opened for reading. Upon function execution file pointers will be set to the next character in the file.</p> <p>Parameters:</p> <p>- <code>bdata</code>: buffer to store read byte to. Upon this function execution read byte is returned through this parameter.</p>
Requires	<p>MMC/SD card and MMC library must be initialized for file operations. See <code>Mmc_Fat_Init</code>.</p> <p>The file must be previously assigned. See <code>Mmc_Fat_Assign</code>.</p> <p>The file must be opened for reading. See <code>Mmc_Fat_Reset</code>.</p>
Example	<pre>dim character as byte ... main: ... Mmc_Fat_Read(character) ... end.</pre>

Mmc_Fat_Rewrite

Prototype	<code>sub procedure Mmc_Fat_Rewrite()</code>
Returns	Nothing.
Description	Opens the currently assigned file for writing. If the file is not empty its content will be erased.
Requires	<p>MMC/SD card and MMC library must be initialized for file operations. See <code>Mmc_Fat_Init</code>.</p> <p>The file must be previously assigned. See <code>Mmc_Fat_Assign</code>.</p>
Example	<pre>' open file for writing Mmc_Fat_Rewrite()</pre>

Mmc_Fat_Append

Prototype	<code>sub procedure Mmc_Fat_Append()</code>
Returns	Nothing.
Description	Opens the currently assigned file for appending. Upon this function execution file pointers will be positioned after the last byte in the file, so any subsequent file write operation will start from there.
Requires	MMC/SD card and MMC library must be initialized for file operations. See <code>Mmc_Fat_Init</code> . The file must be previously assigned. See <code>Mmc_Fat_Assign</code> .
Example	<pre>' open file for appending Mmc_Fat_Append()</pre>

Mmc_Fat_Delete

Prototype	<code>sub procedure Mmc_Fat_Delete()</code>
Returns	Nothing.
Description	Deletes currently assigned file from MMC/SD card.
Requires	MMC/SD card and MMC library must be initialized for file operations. See <code>Mmc_Fat_Init</code> . The file must be previously assigned. See <code>Mmc_Fat_Assign</code> .
Example	<pre>' delete current file Mmc_Fat_Delete()</pre>

Mmc_Fat_Write

Prototype	<code>sub procedure Mmc_Fat_Write(dim byref fdata as byte[512], dim data_len as word)</code>
Returns	Nothing.
Description	Writes requested number of bytes to the currently assigned file opened for writing. Parameters: - <code>fdata</code> : data to be written. - <code>data_len</code> : number of bytes to be written.
Requires	MMC/SD card and MMC library must be initialized for file operations. See <code>Mmc_Fat_Init</code> . The file must be previously assigned. See <code>Mmc_Fat_Assign</code> . The file must be opened for writing. See <code>Mmc_Fat_Rewrite</code> or <code>Mmc_Fat_Append</code> .
Example	<pre>dim file_contents as char[42] ... main: ... Mmc_Fat_Write(file_contents, 42) ' write data to the assigned file ... end.</pre>

Mmc_Fat_Set_File_Date

Prototype	<code>sub procedure Mmc_Fat_Set_File_Date(dim year as word, dim month, day, hours, mins, seconds as byte)</code>
Returns	Nothing.
Description	<p>Sets the date/time stamp. Any subsequent file write operation will write this stamp to the currently assigned file's time/date attributs.</p> <p>Parameters:</p> <ul style="list-style-type: none"> - <code>year</code>: year attribute. Valid values: 1980-2107 - <code>month</code>: month attribute. Valid values: 1-12 - <code>day</code>: day attribute. Valid values: 1-31 - <code>hours</code>: hours attribute. Valid values: 0-23 - <code>mins</code>: minutes attribute. Valid values: 0-59 - <code>seconds</code>: seconds attribute. Valid values: 0-59
Requires	<p>MMC/SD card and MMC library must be initialized for file operations. See <code>Mmc_Fat_Init</code>.</p> <p>The file must be previously assigned. See <code>Mmc_Fat_Assign</code>.</p> <p>The file must be opened for writing. See <code>Mmc_Fat_Rewrite</code> or <code>Mmc_Fat_Append</code>.</p>
Example	<code>Mmc_Fat_Set_File_Date(2005,9,30,17,41,0)</code>

Mmc_Fat_Get_File_Date

Prototype	<code>sub procedure Mmc_Fat_Get_File_Date(dim byref year as word, dim byref month, day, hours, mins as byte)</code>
Returns	Nothing.
Description	<p>Reads time/date attributes of the currently assigned file.</p> <p>Parameters:</p> <ul style="list-style-type: none"> - <code>year</code>: buffer to store year attribute to. Upon function execution year attribute is returned through this parameter. - <code>month</code>: buffer to store month attribute to. Upon function execution month attribute is returned through this parameter. - <code>day</code>: buffer to store day attribute to. Upon function execution day attribute is returned through this parameter. - <code>hours</code>: buffer to store hours attribute to. Upon function execution hours attribute is returned through this parameter. - <code>mins</code>: buffer to store minutes attribute to. Upon function execution minutes attribute is returned through this parameter.
Requires	<p>MMC/SD card and MMC library must be initialized for file operations. See <code>Mmc_Fat_Init</code>.</p> <p>The file must be previously assigned. See <code>Mmc_Fat_Assign</code>.</p>
Example	<pre>dim year as word month, day, hours, mins as byte ... main: ... Mmc_Fat_Get_File_Date(year, month, day, hours, mins) ... end.</pre>

Mmc_Fat_Get_File_Size

Prototype	<code>sub function Mmc_Fat_Get_File_Size() as longword</code>
Returns	Size of the currently assigned file in bytes.
Description	This function reads size of the currently assigned file in bytes.
Requires	MMC/SD card and MMC library must be initialized for file operations. See Mmc_Fat_Init. The file must be previously assigned. See Mmc_Fat_Assign.
Example	<pre> dim my_file_size as longword ... main: ... my_file_size = Mmc_Fat_Get_File_Size ... end. </pre>

Mmc_Fat_Get_Swap_File

Prototype	<code>sub function Mmc_Fat_Get_Swap_File(dim sectors_cnt as longint, dim byref filename as string[11], dim file_attr as byte) as dword</code>
Returns	<ul style="list-style-type: none"> - Number of the start sector for the newly created swap file, if there was enough free space on the MMC/SD card to create file of required size. - 0 - otherwise.
Description	<p>This function is used to create a swap file of predefined name and size on the MMC/SD media. If a file with specified name already exists on the media, search for consecutive sectors will ignore sectors occupied by this file. Therefore, it is recommended to erase such file if it already exists before calling this function. If it is not erased and there is still enough space for a new swap file, this function will delete it after allocating new memory space for a new swap file.</p> <p>The purpose of the swap file is to make reading and writing to MMC/SD media as fast as possible, by using the <code>Mmc_Read_Sector()</code> and <code>Mmc_Write_Sector()</code> functions directly, without potentially damaging the FAT system. The swap file can be considered as a "window" on the media where the user can freely write/read data. It's main purpose in the mikroBasic PRO for AVR's library is to be used for fast data acquisition; when the time-critical acquisition has finished, the data can be re-written into a "normal" file, and formatted in the most suitable way.</p> <p>Parameters:</p> <ul style="list-style-type: none"> - <code>sectors_cnt</code>: number of consecutive sectors that user wants the swap file to have. - <code>filename</code>: name of the file that should be assigned for file operations. File name should be in DOS 8.3 (file_name.extension) format. The file name and extension will be automatically padded with spaces by the library if they have less than length required (i.e. "mikro.tx" -> "mikro .tx "), so the user does not have to take care of that. The file name and extension are case insensitive. The library will convert them to proper case automatically, so the user does not have to take care of that. <p>Also, in order to keep backward compatibility with the first version of this library, file names can be entered as UPPERCASE string of 11 bytes in length with no dot character between file name and extension (i.e. "MIKROELETXT" -> MIKROELE.TXT). In this case last 3 characters of the string are considered to be file extension.</p> <ul style="list-style-type: none"> - <code>file_attr</code>: file creation and attributes flags. Each bit corresponds to the appropriate file attribute:

Description	Bit	Mask	Description
	0	0x01	Read Only
	1	0x02	Hidden
	2	0x04	System
	3	0x08	Volume Label
	4	0x10	Subdirectory
	5	0x20	Archive
	6	0x40	Device (internal use only, never found on disk)
	7	0x80	Not used
Note: Long File Names (LFN) are not supported.			
Requires	MMC/SD card and MMC library must be initialized for file operations. See Mmc_Fat_Init.		
Example	<pre>'----- Try to create a swap file with archive attribute, whose size will be at least 1000 sectors. ' If it succeeds, it sends No. of start sector over UART dim size as longword ... main: ... size = Mmc_Fat_Get_Swap_File(1000, "mikroE.txt", 0x20) if size then UART1_Write(0xAA) UART1_Write(Lo(size)) UART1_Write(Hi(size)) UART1_Write(Higher(size)) UART1_Write(Highest(size)) UART1_Write(0xAA) end if ... end.</pre>		

Library Example

The following example demonstrates MMC library test. Upon flashing, insert a MMC/SD card into the module, when you should receive the "Init-OK" message. Then, you can experiment with MMC read and write functions, and observe the results through the Usart Terminal.

```
' if defined, we have a debug messages on PC terminal
program MMC_Test

{$DEFINE RS232_debug}

dim MMC_chip_select as sbit at PORTB.B2
dim MMC_chip_select_direction as sbit at DDRB.B2

' universal variables
dim k, i as word ' universal for loops and other stuff

' Variables for MMC routines
  dData as byte[512] ' Buffer for MMC sector reading/writing
  data_for_registers as byte[16] ' buffer for CID and CSD registers

' Display byte in hex
sub procedure printhex(dim i as byte)
dim bHi, bLo as byte
  bHi = i and 0xF0 ' High nibble
  bHi = bHi >> 4
  bHi = bHi + "0"
  if (bHi>"9") then
    bHi = bHi + 7
  end if
  bLo = (i and 0x0F) + "0" ' Low nibble
  if (bLo>"9") then
    bLo = bLo+7
  end if
  UART1_Write(bHi)
  UART1_Write(bLo)
end sub

main:
  DDRC = 255
  PORTC = 0
  {$IFDEF RS232_debug}
    UART1_Init(19200)
  {$ENDIF}

  Delay_ms(10)
  DDRA = 255
  PORTA = 1
```

```
{ $IFDEF RS232_debug}
    UART1_Write_Text("AVR-Started") ' If AVR present report
    UART1_Write(13)
    UART1_Write(10)
{ $ENDIF}

' Before all, we must initialise a MMC card
SPI1_Init_Advanced(_SPI_MASTER, _SPI_FCY_DIV2, _SPI_CLK_LO_LEADING)
Spi_Rd_Ptr = @SPI1_Read

i = Mmc_Init()
PORTC = i
{ $IFDEF RS232_debug}
    if(i = 0) then
        UART1_Write_Text("MMC Init-OK") ' If MMC present report
        UART1_Write(13)
        UART1_Write(10)
    end if
    if(i) then
        UART1_Write_Text("MMC Init-error") ' If error report
        UART1_Write(13)
        UART1_Write(10)
    end if
{ $ENDIF}

for i=0 to 511
    dData[ i] = "E" ' Fill MMC buffer with same characters
next i
i = Mmc_Write_Sector(55, dData)

{ $IFDEF RS232_debug}
if(i = 0) then
    UART1_Write_Text("Write-OK")
else ' if there are errors.....
    UART1_Write_Text("Write-Error")
end if
UART1_Write(13)
UART1_Write(10)
{ $ENDIF}

' Reading of CID and CSD register on MMC card.....
{ $IFDEF RS232_debug}
i = Mmc_Read_Cid(data_for_registers)
if (i = 0) then
    for k=0 to 15
        printhex(data_for_registers[ k] )
        if(k <> 15) then
            UART1_Write("-")
```

```

        end if
    next k
        UART1_Write(13)
    else
        UART1_Write_Text("CID-error")
    end if
    i = Mmc_Read_Csd(data_for_registers)
    if(i = 0) then
        for k=0 to 15
            printhex(data_for_registers[ k] )
            if(k <> 15) then
                UART1_Write("-")
            end if
        next K
        UART1_Write(13)
        UART1_Write(10)
    else
        UART1_Write_Text("CSD-error")
    end if
    { $ENDIF}
end.

```

Following example consists of several blocks that demonstrate various aspects of usage of the Mmc_Fat16 library. These are:

- Creation of new file and writing down to it.
- Opening existing file and re-writing it (writing from start-of-file).
- Opening existing file and appending data to it (writing from end-of-file).
- Opening a file and reading data from it (sending it to USART terminal).
- Creating and modifying several files at once.

Program MMC_FAT_Test

```

dim
    Mmc_Chip_Select as sbit at PORTG.B1
    Mmc_Chip_Select_Direction as sbit at DDRG.B1

dim
    FAT_TXT as string[ 20]
    file_contents as string[ 50]

    filename as string[ 14] ' File names

    character as byte
    loop_, loop2 as byte
    size as longint

    buffer as byte[ 512]

```

```
'----- Writes string to USART
sub procedure Write_Str(dim byref ostr as byte[ 2])
dim
  i as byte
  i = 0
  while ostr[i] <> 0
    UART1_Write (ostr[i])
    Inc(i)
  wend
  UART1_Write($0A)
end sub'~

'----- Creates new file and writes some data to it
sub procedure Create_New_File
  filename[ 7] = "A"           ' Set filename for single-file
tests
  Mmc_Fat_Assign(filename, 0xA0) ' Will not find file and then cre-
ate file
  Mmc_Fat_Rewrite             ' To clear file and start with
new data
  for loop_ = 1 to 99       ' We want 5 files on the MMC
card
    UART1_Write(".")
    file_contents[ 0] = loop_ div 10 + 48
    file_contents[ 1] = loop_ mod 10 + 48
    Mmc_Fat_Write(file_contents, 42) ' write data to the assigned
file
  next loop_
end sub'~

'----- Creates many new files and writes data to them
sub procedure Create_Multiple_Files
  for loop2 = "B" to "Z"
    UART1_Write(loop2)           ' this line can slow down
the performance
    filename[ 7] = loop2         ' set filename
    Mmc_Fat_Assign(filename, 0xA0) ' find existing file or cre-
ate a new one
    Mmc_Fat_Rewrite             ' To clear file and start
with new data
    for loop_ = 1 to 44
      file_contents[ 0] = byte(loop_ div 10 + 48)
      file_contents[ 1] = byte(loop_ mod 10 + 48)
      Mmc_Fat_Write(file_contents, 42) ' write data to the assigned
file
    next loop_
  next loop2
end sub'~
```

```
'----- Opens an existing file and rewrites it
sub procedure Open_File_Rewrite
  filename[ 7] = "C"           ' Set filename for single-file tests
  Mmc_Fat_Assign(filename, 0)
  Mmc_Fat_Rewrite
  for loop_ = 1 to 55
    file_contents[ 0] = byte(loop_ div 10 + 48)
    file_contents[ 1] = byte(loop_ mod 10 + 48)
    Mmc_Fat_Write(file_contents, 42) ' write data to the assigned
file
  next loop_
end sub'~

'----- Opens an existing file and appends data to it
'
'           (and alters the date/time stamp)
sub procedure Open_File_Append
  filename[ 7] = "B"
  Mmc_Fat_Assign(filename, 0)
  Mmc_Fat_Set_File_Date(2005,6,21,10,35,0)
  Mmc_Fat_Append()           ' Prepare file for append
  file_contents = " for mikroElektronika 2007"           ' Prepare file
for append
  file_contents[ 26] = 10           ' LF
  Mmc_Fat_Write(file_contents, 27) ' Write data to assigned file
end sub'~

'----- Opens an existing file, reads data from it and puts
it to USART
sub procedure Open_File_Read

  filename[ 7] = "B"
  Mmc_Fat_Assign(filename, 0)
  Mmc_Fat_Reset(size)           ' To read file, sub proce-
dure returns size of file
  while size > 0
    Mmc_Fat_Read(character)
    UART1_Write(character)           ' Write data to USART
    Dec(size)
  wend
end sub'~

'----- Deletes a file. If file doesn't exist, it will first
be created
'
'           and then deleted.
sub procedure Delete_File
  filename[ 7] = "F"
  Mmc_Fat_Assign(filename, 0)
  Mmc_Fat_Delete
end sub'~
```

```
'----- Tests whether file exists, and if so sends its cre-
ation date
'
      and file size via USART
sub procedure Test_File_Exist
dim
    fsize as longint
    year as word
    month_, day, hour_, minute_ as byte
    outstr as byte[12]

    filename[7] = "B"
if Mmc_Fat_Assign(filename, 0) <> 0 then
    '--- file has been found - get its date
    Mmc_Fat_Get_File_Date(year,month_,day,hour_,minute_)
    WordToStr(year, outstr)
    Write_Str(outstr)
    ByteToStr(month_, outstr)
    Write_Str(outstr)
    WordToStr(day, outstr)
    Write_Str(outstr)
    WordToStr(hour_, outstr)
    Write_Str(outstr)
    WordToStr(minute_, outstr)
    Write_Str(outstr)
    '--- get file size
    fsize = Mmc_Fat_Get_File_Size
    LongIntToStr(fsize, outstr)
    Write_Str(outstr)
else
    '--- file was not found - signal it
    UART1_Write(0x55)
    Delay_ms(1000)
    UART1_Write(0x55)
end if
end sub'~

'----- Tries to create a swap file, whose size will be at
least 100
'
      sectors (see Help for details)
sub procedure M_Create_Swap_File()
dim i as word

    for i=0 to 511
        Buffer[i] = i
    next i

    size = Mmc_Fat_Get_Swap_File(5000, "mikroE.txt", 0x20) ' see help
on this sub function for details
```



```

if (size <> 0) then
    LongIntToStr(size, fat_txt)
    UART1_Write_Text(fat_txt)

    for i=0 to 4999
        Mmc_Write_Sector(size, Buffer)
        size = size + 1
        UART1_Write(".")
    next i
end if
end sub

'----- Main. Uncomment the sub function(s) to test the
desired operation(s)
main:
    FAT_TXT = "FAT16 not found"
    file_contents = "XX MMC/SD FAT16 library by Anton Rieckert#"
    file_contents[ 41] = 10           ' newline
    filename = "MIKRO00xTXT"

    ' we will use PORTC to signal test end
    DDRC = 0xFF
    PORTC = 0
    UART1_Init(19200)
    'delay_ms(100)           ' Set up USART for file reading
    UART1_Write_Text("Start")
    '--- Init the FAT library
    SPI1_Init_Advanced(_SPI_MASTER, _SPI_FCY_DIV128, _SPI_CLK_LO_LEADING)
    Spi_Rd_Ptr = @SPI1_Read
    ' use fat16 quick format instead of init routine if a formatting
    is needed
    if Mmc_Fat_Init() = 0 then
        PORTC = 0xF0
        ' reinitialize spi at higher speed
        SPI1_Init_Advanced(_SPI_MASTER, _SPI_FCY_DIV2, _SPI_CLK_LO_LEADING)
        '--- signal start-of-test
        '--- test sub functions
        Create_New_File
        Create_Multiple_Files

        Open_File_Rewrite
        Open_File_Append
        Open_File_Read
        Delete_File
        Test_File_Exist
        M_Create_Swap_File()
        UART1_Write("e")
    else
        UART1_Write_Text(FAT_TXT)
    end if
    '--- signal end-of-test
    PORTC = $0F
    UART1_Write_Text("End")
end. '~!

```

HW Connection

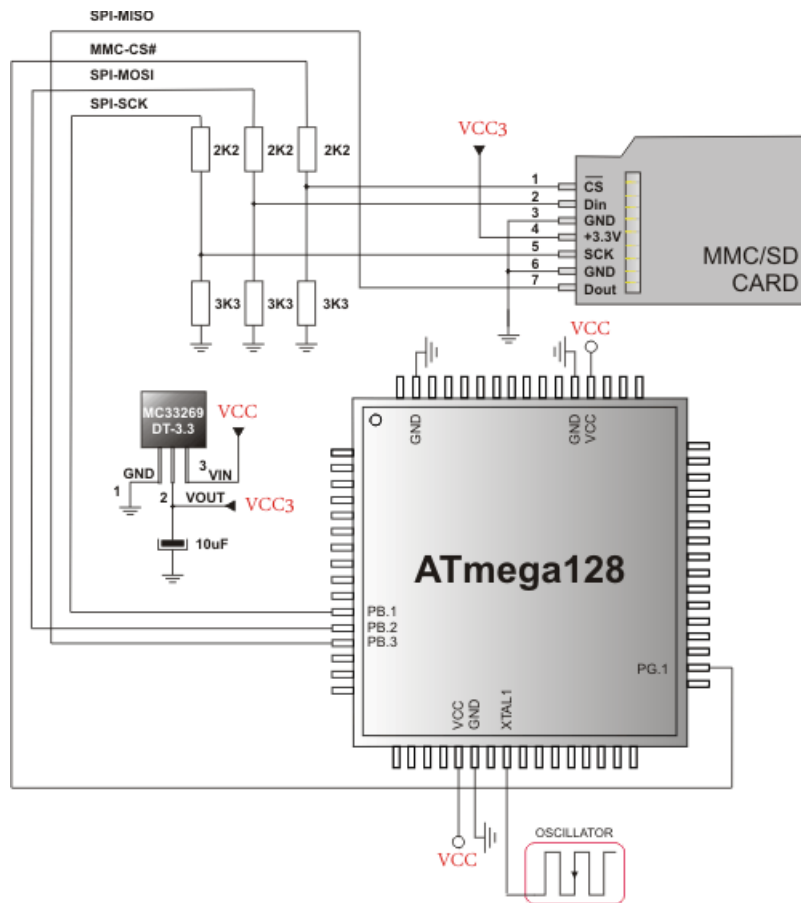

Pin diagram of MMC memory card

ONEWIRE LIBRARY

The OneWire library provides routines for communication via the Dallas OneWire protocol, e.g. with DS18x20 digital thermometer. OneWire is a Master/Slave protocol, and all communication cabling required is a single wire. OneWire enabled devices should have open collector drivers (with single pull-up resistor) on the shared data line.

Slave devices on the OneWire bus can even get their power supply from data line. For detailed schematic see device datasheet.

Some basic characteristics of this protocol are:

- single master system,
- low cost,
- low transfer rates (up to 16 kbps),
- fairly long distances (up to 300 meters),
- small data transfer packages.

Each OneWire device has also a unique 64-bit registration number (8-bit device type, 48-bit serial number and 8-bit CRC), so multiple slaves can co-exist on the same bus.

Note: Oscillator frequency F_{osc} needs to be at least 8MHz in order to use the routines with Dallas digital thermometers.

External dependencies of OneWire Library

This variable must be defined in any project that is using OneWire Library:	Description:	Example :
<code>dim OW_Bit_Read as sbit sfr external</code>	OneWire read line.	<code>dim OW_Bit_Read as sbit at PINB.B2</code>
<code>dim OW_Bit_Write as sbit sfr external</code>	OneWire write line.	<code>dim OW_Bit_Write as sbit at PORTB.B2</code>
<code>dim OW_Bit_Direction as sbit sfr external</code>	Direction of the OneWire pin.	<code>dim OW_Bit_Direction as sbit at DDRB.B2</code>

Library Routines

- Ow_Reset
- Ow_Read
- Ow_Write

Ow_Reset

Prototype	<code>sub function Ow_Reset() as word</code>
Returns	<ul style="list-style-type: none"> - 0 if the device is present - 1 if the device is not present
Description	<p>Issues OneWire reset signal for DS18x20.</p> <p>Parameters :</p> <ul style="list-style-type: none"> - None.
Requires	<p>Devices compliant with the Dallas OneWire protocol.</p> <p>Global variables :</p> <ul style="list-style-type: none"> - <code>OW_Bit_Read</code>: OneWire read line - <code>OW_Bit_Write</code>: OneWire write line. - <code>OW_Bit_Direction</code>: Direction of the OneWire pin <p>must be defined before using this function.</p>
Example	<pre>' OneWire pinout dim OW_Bit_Read as sbit at PINB.B2 dim OW_Bit_Write as sbit at PORTB.B2 dim OW_Bit_Direction as sbit at DDRB.B2 ' end of OneWire pinout ' Issue Reset signal on One-Wire Bus Ow_Reset()</pre>

Ow_Read

Prototype	<code>sub function Ow_Read() as byte</code>
Returns	Data read from an external device over the OneWire bus.
Description	Reads one byte of data via the OneWire bus.
Requires	<p>Devices compliant with the Dallas OneWire protocol.</p> <p>Global variables :</p> <ul style="list-style-type: none"> - <code>OW_Bit_Read</code>: OneWire read line - <code>OW_Bit_Write</code>: OneWire write line. - <code>OW_Bit_Direction</code>: Direction of the OneWire pin <p>must be defined before using this function.</p>
Example	<pre>// OneWire pinout dim OW_Bit_Read as sbit at PINB.B2 dim OW_Bit_Write as sbit at PORTB.B2 dim OW_Bit_Direction as sbit at DDRB.B2 // end of OneWire pinout ' Read a byte from the One-Wire Bus dim read_data as byte ... read_data = Ow_Read()</pre>

Ow_Write

Prototype	<code>sub procedure Ow_Write(dim par as byte)</code>
Returns	Nothing.
Description	Writes one byte of data via the OneWire bus. Parameters : - <code>par</code> : data to be written
Requires	Devices compliant with the Dallas OneWire protocol. Global variables : - <code>OW_Bit_Read</code> : OneWire read line - <code>OW_Bit_Write</code> : OneWire write line. - <code>OW_Bit_Direction</code> : Direction of the OneWire pin must be defined before using this function.
Example	<pre>// OneWire pinout dim OW_Bit_Read as sbit at PINB.B2 dim OW_Bit_Write as sbit at PORTB.B2 dim OW_Bit_Direction as sbit at DDRB.B2 // end of OneWire pinout ' Send a byte to the One-Wire Bus Ow_Write(0xCC)</pre>

Library Example

This example reads the temperature using DS18x20 connected to pin PORTB.2. After reset, MCU obtains temperature from the sensor and prints it on the Lcd. Make sure to pull-up PORTB.2 line and to turn off the PORTB leds.

program OneWire

```
' Lcd module connections
dim LCD_RS as sbit at PORTD.B2
  LCD_EN as sbit at PORTD.B3
  LCD_D4 as sbit at PORTD.B4
  LCD_D5 as sbit at PORTD.B5
  LCD_D6 as sbit at PORTD.B6
  LCD_D7 as sbit at PORTD.B7
  LCD_RS_Direction as sbit at DDRD.B2
  LCD_EN_Direction as sbit at DDRD.B3
  LCD_D4_Direction as sbit at DDRD.B4
  LCD_D5_Direction as sbit at DDRD.B5
  LCD_D6_Direction as sbit at DDRD.B6
  LCD_D7_Direction as sbit at DDRD.B7
' End Lcd module connections

' OneWire pinout
dim OW_Bit_Write as sbit at PORTB.B2
  OW_Bit_Read as sbit at PINB.B2
  OW_Bit_Direction as sbit at DDRB.B2
' end OneWire definition

' Set TEMP_RESOLUTION to the corresponding resolution of used
DS18x20 sensor:
' 18S20: 9 (default setting can be 9,10,11,or 12)
' 18B20: 12
const TEMP_RESOLUTION as byte = 12

dim text as byte[ 9]
  temp as word

sub procedure Display_Temperature( dim temp2write as word )
const RES_SHIFT = TEMP_RESOLUTION - 8

dim temp_whole as byte
  temp_fraction as word

  text = "000.0000"
  ' check if temperature is negative
  if (temp2write and 0x8000) then
    text[ 0 ] = "-"
    temp2write = not temp2write + 1
  end if
```

```
' extract temp_whole
  temp_whole = word(temp2write >> RES_SHIFT)

  ' convert temp_whole to characters
  if ( temp_whole div 100 ) then
    text[ 0] = temp_whole div 100 + 48
  else
    text[ 0] = "0"
  end if

text[ 1] = (temp_whole div 10)mod 10 + 48 ' Extract tens digit
text[ 2] = temp_whole mod 10 + 48 ' Extract ones digit

' extract temp_fraction and convert it to unsigned int
temp_fraction = word(temp2write << (4-RES_SHIFT))
temp_fraction = temp_fraction and 0x000F
temp_fraction = temp_fraction * 625

' convert temp_fraction to characters
text[ 4] = word(temp_fraction div 1000) + 48 ' Extract
thousands digit
text[ 5] = word((temp_fraction div 100)mod 10 + 48) '
Extract hundreds digit
text[ 6] = word((temp_fraction div 10)mod 10 + 48) '
Extract tens digit
text[ 7] = word(temp_fraction mod 10) + 48 ' Extract
ones digit

' print temperature on Lcd
  Lcd_Out(2, 5, text)
end sub

main:
  text = "000.0000"
  UART1_Init(9600)
  Lcd_Init() ' Initialize Lcd
  Lcd_Cmd(LCD_CLEAR) ' Clear Lcd
  Lcd_Cmd(LCD_CURSOR_OFF) ' Turn cursor off
  Lcd_Out(1, 1, " Temperature: ")
  ' Print degree character, "C" for Centigrades
  Lcd_Chrc(2,13,178) ' different Lcd displays have different char
code for degree
' if you see greek alpha letter try typing
178 instead of 223
  Lcd_Chrc(2,14,"C")

'--- main loop
while TRUE
```



```
'--- perform temperature reading
Ow_Reset()      ' Onewire reset signal
Ow_Write(0xCC)  ' Issue command SKIP_ROM
Ow_Write(0x44)  ' Issue command CONVERT_T
Delay_us(120)

Ow_Reset()
Ow_Write(0xCC)  ' Issue command SKIP_ROM
Ow_Write(0xBE)  ' Issue command READ_SCRATCHPAD

temp = Ow_Read()
temp = (Ow_Read() << 8) + temp

'--- Format and display result on Lcd

Display_Temperature(temp)

Delay_ms(520)

wend
end.
```

HW Connection

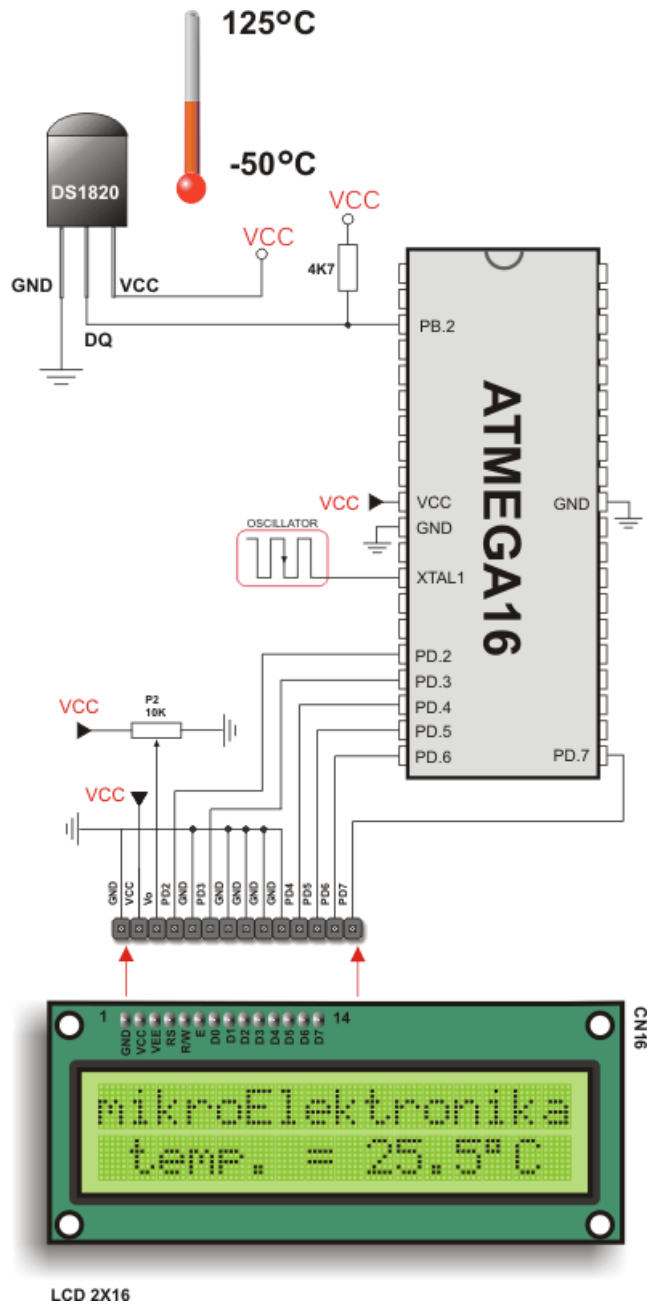

Example of DS1820 connection

PORT EXPANDER LIBRARY

The mikroBasic PRO for AVR provides a library for communication with the Microchip's Port Expander MCP23S17 via SPI interface. Connections of the AVR compliant MCU and MCP23S17 is given on the schematic at the bottom of this page.

Note: Library uses the SPI module for communication. The user must initialize SPI module before using the Port Expander Library.

Note: Prior to calling any of this library routines, Spi_Rd_Ptr needs to be initialized with the appropriate SPI_Read routine.

Note: Library does not use Port Expander interrupts.

External dependencies of Port Expander Library

The following variables must be defined in all projects using Port Expander Library:	Description:	Example :
<code>dim SPExpanderRST as sbit sfr external</code>	Reset line.	<code>dim SPExpanderRST as sbit at PORTB.B0</code>
<code>dim SPExpanderRST as sbit at PORTB.B0</code>	Chip Select line.	<code>dim SPExpanderCS as sbit at PORTB.B1</code>
<code>dim SPExpanderRST_Direction as sbit sfr external</code>	Direction of the Reset pin.	<code>dim SPExpanderRST_Direction as sbit at DDRB.B0</code>
<code>dim SPExpanderCS_Direction as sbit sfr external</code>	Direction of the Chip Select pin.	<code>dim SPExpanderCS_Directions as sbit at DDRB.B1</code>

Library Routines

- Expander_Init
- Expander_Read_Byte
- Expander_Write_Byte
- Expander_Read_PortA
- Expander_Read_PortB
- Expander_Read_PortAB
- Expander_Write_PortA
- Expander_Write_PortB

- Expander_Write_PortAB
- Expander_Set_DirectionPortA
- Expander_Set_DirectionPortB
- Expander_Set_DirectionPortAB
- Expander_Set_PullUpsPortA
- Expander_Set_PullUpsPortB
- Expander_Set_PullUpsPortAB

Expander_Init

Prototype	<code>sub procedure Expander_Init(dim ModuleAddress as byte)</code>
Returns	Nothing.
Description	<p>Initializes Port Expander using SPI communication.</p> <p>Port Expander module settings :</p> <ul style="list-style-type: none"> - hardware addressing enabled - automatic address pointer incrementing disabled (byte mode) - BANK_0 register addressing - slew rate enabled <p>Parameters :</p> <ul style="list-style-type: none"> - <code>ModuleAddress</code>: Port Expander hardware address, see schematic at the bottom of this page
Requires	<p>Global variables :</p> <ul style="list-style-type: none"> - <code>SPExpanderCS</code>: Chip Select line - <code>SPExpanderRST</code>: Reset line - <code>SPExpanderCS_Direction</code>: Direction of the Chip Select pin - <code>SPExpanderRST_Direction</code>: Direction of the Reset pin <p>must be defined before using this function.</p> <p>SPI module needs to be initialized. See <code>SPI1_Init</code> and <code>SPI1_Init_Advanced</code> routines.</p>
Example	<pre>' port expander pinout definition dim SPExpanderCS as sbit at PORTB.B1 SPExpanderRST as sbit at PORTB.B0 SPExpanderCS_Direction as sbit at DDRB.B1 SPExpanderRST_Direction as sbit at DDRB.B0 ... SPI1_Init() ' initialize SPI module Spi_Rd_Ptr = @SPI1_Read ' Pass pointer to SPI Read function of used SPI module Expander_Init(0) ' initialize port expander</pre>

Expander_Read_Byte

Prototype	<code>sub function Expander_Read_Byte(dim ModuleAddress as byte, dim RegAddress as byte) as byte</code>
Returns	Byte read.
Description	<p>The function reads byte from Port Expander.</p> <p>Parameters :</p> <ul style="list-style-type: none"> - <code>ModuleAddress</code>: Port Expander hardware address, see schematic at the bottom of this page - <code>RegAddress</code>: Port Expander's internal register address
Requires	Port Expander must be initialized. See <code>Expander_Init</code> .
Example	<pre>' Read a byte from Port Expander's register dim read_data as byte ... read_data = Expander_Read_Byte(0,1)</pre>

Expander_Write_Byte

Prototype	<code>sub procedure Expander_Write_Byte(dim ModuleAddress as byte, dim RegAddress as byte, dim Data_ as byte)</code>
Returns	Nothing.
Description	<p>Routine writes a byte to Port Expander.</p> <p>Parameters :</p> <ul style="list-style-type: none"> - <code>ModuleAddress</code>: Port Expander hardware address, see schematic at the bottom of this page - <code>RegAddress</code>: Port Expander's internal register address - <code>Data_</code>: data to be written
Requires	Port Expander must be initialized. See <code>Expander_Init</code> .
Example	<pre>' Write a byte to the Port Expander's register Expander_Write_Byte(0,1,0xFF)</pre>

Expander_Read_PortA

Prototype	<code>sub function Expander_Read_PortA(dim ModuleAddress as byte) as byte</code>
Returns	Byte read.
Description	The function reads byte from Port Expander's PortA. Parameters : - ModuleAddress : Port Expander hardware address, see schematic at the bottom of this page
Requires	Port Expander must be initialized. See Expander_Init. Port Expander's PortA should be configured as input. See Expander_Set_DirectionPortA and Expander_Set_DirectionPortAB routines.
Example	<pre>' Read a byte from Port Expander's PORTA dim read_data as byte ... Expander_Set_DirectionPortA(0,0xFF) ' set expander's porta to be input ... read_data = Expander_Read_PortA(0)</pre>

Expander_Read_PortB

Prototype	<code>sub function Expander_Read_PortB(dim ModuleAddress as byte) as byte</code>
Returns	Byte read.
Description	The function reads byte from Port Expander's PortB. Parameters : - ModuleAddress : Port Expander hardware address, see schematic at the bottom of this page
Requires	Port Expander must be initialized. See Expander_Init. Port Expander's PortB should be configured as input. See Expander_Set_DirectionPortB and Expander_Set_DirectionPortAB routines.
Example	<pre>' Read a byte from Port Expander's PORTB dim read_data as byte ... Expander_Set_DirectionPortB(0,0xFF) ' set expander's portb to be input ... read_data = Expander_Read_PortB(0)</pre>

Expander_Read_PortAB

Prototype	<code>sub function Expander_Read_PortAB(dim ModuleAddress as byte) as word</code>
Returns	Word read.
Description	<p>The function reads word from Port Expander's ports. PortA readings are in the higher byte of the result. PortB readings are in the lower byte of the result.</p> <p>Parameters :</p> <ul style="list-style-type: none"> - <code>ModuleAddress</code>: Port Expander hardware address, see schematic at the bottom of this page
Requires	<p>Port Expander must be initialized. See <code>Expander_Init</code>.</p> <p>Port Expander's PortA and PortB should be configured as inputs. See <code>Expander_Set_DirectionPortA</code>, <code>Expander_Set_DirectionPortB</code> and <code>Expander_Set_DirectionPortAB</code> routines.</p>
Example	<pre>' Read a byte from Port Expander's PORTA and PORTB dim read_data as word ... Expander_Set_DirectionPortAB(0,0xFFFF) ' set expander's porta and portb to be input ... read_data = Expander_Read_PortAB(0)</pre>

Expander_Write_PortA

Prototype	<code>sub procedure Expander_Write_PortA(dim ModuleAddress as byte, dim Data_ as byte)</code>
Returns	Nothing.
Description	<p>The function writes byte to Port Expander's PortA.</p> <p>Parameters :</p> <ul style="list-style-type: none"> - <code>ModuleAddress</code>: Port Expander hardware address, see schematic at the bottom of this page - <code>Data_</code>: data to be written
Requires	<p>Port Expander must be initialized. See <code>Expander_Init</code>.</p> <p>Port Expander's PortA should be configured as output. See <code>Expander_Set_DirectionPortA</code> and <code>Expander_Set_DirectionPortAB</code> routines.</p>
Example	<pre>' Write a byte to Port Expander's PORTA ... Expander_Set_DirectionPortA(0,0x00) ' set expander's porta to be output ... Expander_Write_PortA(0, 0xAA)</pre>

Expander_Write_PortB

Prototype	<code>sub procedure Expander_Write_PortB(dim ModuleAddress as byte, dim Data_ as byte)</code>
Returns	Nothing.
Description	<p>The function writes byte to Port Expander's PortB.</p> <p>Parameters :</p> <ul style="list-style-type: none"> - <code>ModuleAddress</code>: Port Expander hardware address, see schematic at the bottom of this page - <code>Data_</code>: data to be written
Requires	<p>Port Expander must be initialized. See <code>Expander_Init</code>.</p> <p>Port Expander's PortB should be configured as output. See <code>Expander_Set_DirectionPortB</code> and <code>Expander_Set_DirectionPortAB</code> routines.</p>
Example	<pre>' Write a byte to Port Expander's PORTB ... Expander_Set_DirectionPortB(0,0x00) ' set expander's portb to be output ... Expander_Write_PortB(0, 0x55)</pre>

Expander_Write_PortAB

Prototype	<code>sub procedure Expander_Write_PortAB(dim ModuleAddress as byte, dim Data_ as word)</code>
Returns	Nothing.
Description	<p>The function writes word to Port Expander's ports.</p> <p>Parameters :</p> <ul style="list-style-type: none"> - <code>ModuleAddress</code>: Port Expander hardware address, see schematic at the bottom of this page - <code>Data_</code>: data to be written. Data to be written to PortA are passed in <code>Data's</code> higher byte. Data to be written to PortB are passed in <code>Data's</code> lower byte
Requires	<p>Port Expander must be initialized. See <code>Expander_Init</code>.</p> <p>Port Expander's PortA and PortB should be configured as outputs. See <code>Expander_Set_DirectionPortA</code>, <code>Expander_Set_DirectionPortB</code> and <code>Expander_Set_DirectionPortAB</code> routines.</p>
Example	<pre>' Write a byte to Port Expander's PORTA and PORTB ... Expander_Set_DirectionPortAB(0,0x0000) ' set expander's porta and portb to be output ... Expander_Write_PortAB(0, 0xAA55)</pre>

Expander_Set_DirectionPortA

Prototype	<code>sub procedure Expander_Set_DirectionPortA(dim ModuleAddress as byte, dim Data_ as byte)</code>
Returns	Nothing.
Description	<p>The function sets Port Expander's PortA direction.</p> <p>Parameters :</p> <ul style="list-style-type: none"> - ModuleAddress: Port Expander hardware address, see schematic at the bottom of this page - Data_: data to be written to the PortA direction register. Each bit corresponds to the appropriate pin of the PortA register. Set bit designates corresponding pin as input. Cleared bit designates corresponding pin as output.
Requires	Port Expander must be initialized. See Expander_Init.
Example	<code>' Set Port Expander's PORTA to be output Expander_Set_DirectionPortA(0,0x00)</code>

Expander_Set_DirectionPortB

Prototype	<code>sub procedure Expander_Set_DirectionPortB(dim ModuleAddress as byte, dim Data_ as byte)</code>
Returns	Nothing.
Description	<p>The function sets Port Expander's PortB direction.</p> <p>Parameters :</p> <ul style="list-style-type: none"> - ModuleAddress: Port Expander hardware address, see schematic at the bottom of this page - Data_: data to be written to the PortB direction register. Each bit corresponds to the appropriate pin of the PortB register. Set bit designates corresponding pin as input. Cleared bit designates corresponding pin as output.
Requires	Port Expander must be initialized. See Expander_Init.
Example	<code>' Set Port Expander's PORTB to be input Expander_Set_DirectionPortB(0,0xFF)</code>

Expander_Set_DirectionPortAB

Prototype	<code>sub procedure Expander_Set_DirectionPortAB(dim ModuleAddress as byte, dim Direction as word)</code>
Returns	Nothing.
Description	<p>The function sets Port Expander's PortA and PortB direction.</p> <p>Parameters :</p> <ul style="list-style-type: none"> - <code>ModuleAddress</code>: Port Expander hardware address, see schematic at the bottom of this page - <code>Direction</code>: data to be written to direction registers. Data to be written to the PortA direction register are passed in Direction's higher byte. Data to be written to the PortB direction register are passed in Direction's lower byte. Each bit corresponds to the appropriate pin of the PortA/PortB register. Set bit designates corresponding pin as input. Cleared bit designates corresponding pin as output.
Requires	Port Expander must be initialized. See <code>Expander_Init</code> .
Example	<code>' Set Port Expander's PORTA to be output and PORTB to be input Expander_Set_DirectionPortAB(0,0x00FF)</code>

Expander_Set_PullUpsPortA

Prototype	<code>sub procedure Expander_Set_PullUpsPortA(dim ModuleAddress as byte, dim Data_ as byte)</code>
Returns	Nothing.
Description	<p>The function sets Port Expander's PortA pull up/down resistors.</p> <p>Parameters :</p> <ul style="list-style-type: none"> - <code>ModuleAddress</code>: Port Expander hardware address, see schematic at the bottom of this page - <code>Data_</code>: data for choosing pull up/down resistors configuration. Each bit corresponds to the appropriate pin of the PortA register. Set bit enables pull-up for corresponding pin.
Requires	Port Expander must be initialized. See <code>Expander_Init</code> .
Example	<code>' Set Port Expander's PORTA pull-up resistors Expander_Set_PullUpsPortA(0, 0xFF)</code>

Expander_Set_PullUpsPortB

Prototype	<code>sub procedure Expander_Set_PullUpsPortB(dim ModuleAddress as byte, dim Data_ as byte)</code>
Returns	Nothing.
Description	<p>The function sets Port Expander's PortB pull up/down resistors.</p> <p>Parameters :</p> <ul style="list-style-type: none"> - <code>ModuleAddress</code>: Port Expander hardware address, see schematic at the bottom of this page - <code>Data_</code>: data for choosing pull up/down resistors configuration. Each bit corresponds to the appropriate pin of the PortB register. Set bit enables pull-up for corresponding pin.
Requires	Port Expander must be initialized. See <code>Expander_Init</code> .
Example	<code>' Set Port Expander's PORTB pull-up resistors Expander_Set_PullUpsPortB(0, 0xFF)</code>

Expander_Set_PullUpsPortAB

Prototype	<code>sub procedure Expander_Set_PullUpsPortAB(dim ModuleAddress as byte, dim PullUps as word)</code>
Returns	Nothing.
Description	<p>The function sets Port Expander's PortA and PortB pull up/down resistors.</p> <p>Parameters :</p> <ul style="list-style-type: none"> - <code>ModuleAddress</code>: Port Expander hardware address, see schematic at the bottom of this page - <code>PullUps</code>: data for choosing pull up/down resistors configuration. PortA pull up/down resistors configuration is passed in <code>PullUps</code>'s higher byte. PortB pull up/down resistors configuration is passed in <code>PullUps</code>'s lower byte. Each bit corresponds to the appropriate pin of the PortA/PortB register. Set bit enables pull-up for corresponding pin.
Requires	Port Expander must be initialized. See <code>Expander_Init</code> .
Example	<code>' Set Port Expander's PORTA and PORTB pull-up resistors Expander_Set_PullUpsPortAB(0, 0xFFFF)</code>

Library Example

The example demonstrates how to communicate with Port Expander MCP23S17.

Note that Port Expander pins A2 A1 A0 are connected to GND so Port Expander Hardware Address is 0.

```
program PortExpander
' Port Expander module connections
dim SPExpanderRST as sbit at PORTB.B0
    SPExpanderCS as sbit at PORTB.B1
    SPExpanderRST_Direction as sbit at DDRB.B0
    SPExpanderCS_Direction as sbit at DDRB.B1
' End Port Expander module connections

dim counter as byte' = 0

main:
    counter = 0
    DDRC = 0xFF ' Set PORTC as output

    ' If Port Expander Library uses SPI1 module
    SPI1_Init() ' Initialize SPI module used with PortExpander
    Spi_Rd_Ptr = @SPI1_Read ' Pass pointer to SPI Read
sub function of used SPI module

    ' If Port Expander Library uses SPI2 module
    ' SPI2_Init() ' Initialize SPI module used with PortExpander
    ' Spi_Rd_Ptr = @SPI2_Read ' Pass pointer to SPI Read
sub function of used SPI module

    Expander_Init(0) ' Initialize Port Expander

    Expander_Set_DirectionPortA(0, 0x00) ' Set Expander"s PORTA to be
output

    Expander_Set_DirectionPortB(0,0xFF) ' Set Expander"s PORTB to be
input
    Expander_Set_PullUpsPortB(0,0xFF) ' Set pull-ups to all of the
Expander"s PORTB pins

    while TRUE ' Endless loop
        Expander_Write_PortA(0, counter) ' Write i to expander"s PORTA
        Inc(counter)
        PORTC = Expander_Read_PortB(0) ' Read expander"s PORTB and
write it to LEDs
        Delay_ms(100)
    wend

end.
```

HW Connection

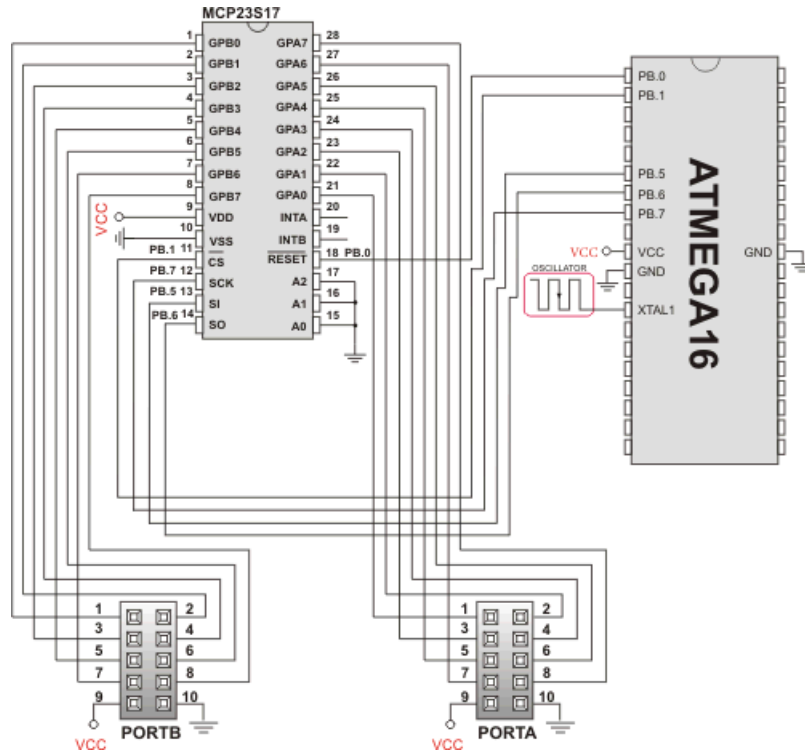

Port Expander HW connection

PS/2 LIBRARY

The mikroBasic PRO for AVR provides a library for communication with the common PS/2 keyboard.

Note: The library does not utilize interrupts for data retrieval, and requires the oscillator clock to be at least 6MHz.

Note: The pins to which a PS/2 keyboard is attached should be connected to the pull-up resistors.

Note: Although PS/2 is a two-way communication bus, this library does not provide MCU-to-keyboard communication; e.g. pressing the Caps Lock key will not turn on the Caps Lock LED.

External dependencies of PS/2 Library

The following variables must be defined in all projects using PS/2 Library:	Description:	Example :
<code>dim PS2_Data as sbit sfr external</code>	PS/2 Data line.	<code>dim PS2_Data as sbit at PINC.B0</code>
<code>dim PS2_In_Clock as sbit sfr external</code>	PS/2 Clock line in.	<code>dim PS2_In_Clock as sbit at PINC.B1</code>
<code>dim PS2_Out_Clock as sbit sfr external</code>	PS/2 Clock line out.	<code>dim PS2_Out_Clock as sbit at PORTC.B0</code>
<code>dim PS2_Data_Direction as sbit sfr external</code>	Direction of the PS/2 Data pin.	<code>dim PS2_Data_Direction as sbit at DDRC.B0</code>
<code>dim PS2_Clock_Direction as sbit sfr external</code>	Direction of the PS/2 Clock pin.	<code>dim PS2_Clock_Direction as sbit at DDRC.B1</code>

Library Routines

- Ps2_Config
- Ps2_Key_Read

Ps2_Config

Prototype	<code>sub procedure Ps2_Config()</code>
Returns	Nothing.
Description	Initializes the MCU for work with the PS/2 keyboard.
Requires	<p>Global variables :</p> <ul style="list-style-type: none"> - <code>PS2_Data</code>: Data signal line - <code>PS2_In_Clock</code>: Clock signal line in - <code>PS2_Out_Clock</code>: Clock signal line out - <code>PS2_Data_Direction</code>: Direction of the Data pin - <code>PS2_Clock_Direction</code>: Direction of the Clock pin <p>must be defined before using this function.</p>
Example	<pre>// PS2 pinout definition dim PS2_Data as sbit at PINC.B0 dim PS2_In_Clock as sbit at PINC.B1 dim PS2_Out_Clock as sbit at PORTC.B1 dim PS2_Data_Direction as sbit at DDRC.B0 dim PS2_Clock_Direction as sbit at DDRC.B1 // End of PS2 pinout definition ... Ps2_Config() ' Init PS/2 Keyboard</pre>

Ps2_Key_Read

Prototype	<code>sub function Ps2_Key_Read(dim byref value as byte, dim byref special as byte, dim byref pressed as byte) as byte</code>
Returns	<ul style="list-style-type: none"> - 1 if reading of a key from the keyboard was successful - 0 if no key was pressed
Description	<p>The function retrieves information on key pressed.</p> <p>Parameters :</p> <ul style="list-style-type: none"> - <code>value</code>: holds the value of the key pressed. For characters, numerals, punctuation marks, and space value will store the appropriate ASCII code. Routine “recognizes” the function of Shift and Caps Lock, and behaves appropriately. For special function keys see Special Function Keys Table. - <code>special</code>: is a flag for special function keys (F1, Enter, Esc, etc). If key pressed is one of these, <code>special</code> will be set to 1, otherwise 0. - <code>pressed</code>: is set to 1 if the key is pressed, and 0 if it is released.
Requires	PS/2 keyboard needs to be initialized. See Ps2_Config routine.
Example	<pre> dim value, special, pressed as byte ... do { if (Ps2_Key_Read(value, special, pressed)) then if ((value = 13) and (special = 1)) then break end if end if loop until (0=1) </pre>

Special Function Keys

Adapter Board	T6369C datasheet
F1	1
F2	2
F3	3
F4	4
F5	5
F6	6
F7	7
F8	8
F9	9
F10	10
F11	11
F12	12
Enter	13
Page Up	14
Page Down	15
Backspace	16
Insert	17
Delete	18
Windows	19
Ctrl	20
Shift	21
Alt	22
Print Screen	23
Pause	24
Caps Lock	25
End	26
Home	27

Scroll Lock	28
Num Lock	29
Left Arrow	30
Right Arrow	31
Up Arrow	32
Down Arrow	33
Escape	34
Tab	35

Library Example

This simple example reads values of the pressed keys on the PS/2 keyboard and sends them via UART.

```
program PS2_Example

dim keydata, special, down as byte

dim PS2_Data          as sbit at PINC.B0
   PS2_Clock_Input    as sbit at PINC.B1
   PS2_Clock_Output   as sbit at PORTC.B1

   PS2_Data_Direction as sbit at DDRC.B0
   PS2_Clock_Direction as sbit at DDRC.B1

main:
   UART1_Init(19200)      ' Initialize UART module at 19200 bps
   Ps2_Config()          ' Init PS/2 Keyboard
   Delay_ms(100)         ' Wait for keyboard to finish
   UART1_Write("R")      ' Ready

   while TRUE           '
Endless loop
   if (Ps2_Key_Read(keydata, special, down) <> 0) then      ' If
data was read from PS/2
   if (((down <> 0) and (keydata = 16)) <> 0) then          '
Backspace read
   UART1_Write(0x08)                                     '
Send Backspace to USART terminal
   else if (((down <> 0) and (keydata = 13)) <> 0) then      '
Enter read
   UART1_Write(10)                                       '
Send carriage return to usart terminal
   UART1_Write(13)                                       '
Uncomment this line if usart terminal also expects line feed
   ' for new line transition
   else if (((down <> 0) and (special = 0) and (keydata <>
0)) <> 0) then      ' Common key read
   UART1_Write(keydata)                                  '
Send key to usart terminal
   end if
   end if
   end if
   end if
   Delay_ms(10)                                         ' Debounce period
wend
end.
```

HW Connection

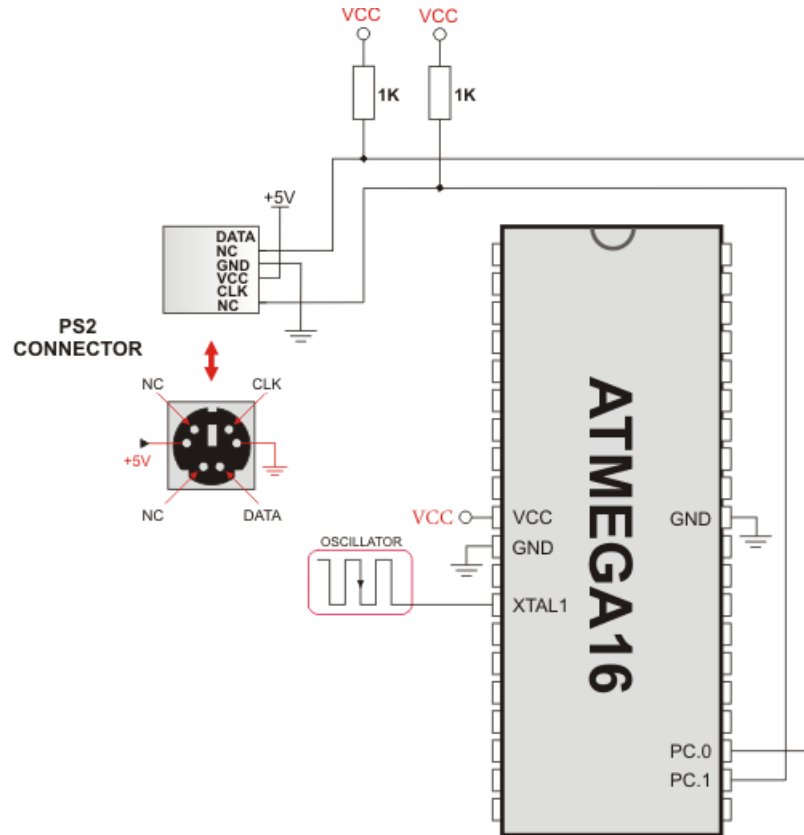

Example of PS2 keyboard connection

PWM LIBRARY

CMO module is available with a number of AVR MCUs. mikroBasic PRO for AVR provides library which simplifies using PWM HW Module.

Note: For better understanding of PWM module it would be best to start with the example provided in Examples folder of our mikroBasic PRO for AVR compiler. When you select a MCU, mikroBasic PRO for AVR automatically loads the correct PWM library (or libraries), which can be verified by looking at the Library Manager. PWM library handles and initializes the PWM module on the given AVR MCU, but it is up to user to set the correct pins as PWM output, this topic will be covered later in this section. mikroBasic PRO for AVR does not support enhanced PWM modules.

Library Routines

- PWM_Init
- PWM_Set_Duty
- PWM_Start
- PWM_Stop
- PWM1_Init
- PWM1_Set_Duty
- PWM1_Start
- PWM1_Stop

Predefined constants used in PWM library

The following variables are used in PWM library functions:	Description:
<code>_PWM_PHASE_CORRECT_MODE</code>	Selects Phase Correct PWM mode on first PWM library.
<code>_PWM1_PHASE_CORRECT_MODE</code>	Selects Phase Correct PWM mode on second PWM library (if it exists in Library Manager).
<code>_PWM_FAST_MODE</code>	Selects Fast PWM mode on first PWM library.
<code>_PWM1_FAST_MODE</code>	Selects Fast PWM mode on second PWM library (if it exists in Library Manager).
<code>_PWM_PRESCALER_1</code>	Sets prescaler value to 1 (No prescaling).
<code>_PWM_PRESCALER_8</code>	Sets prescaler value to 8.
<code>_PWM_PRESCALER_32</code>	Sets prescaler value to 32 (this value is not available on every MCU. Please use Code Assistant to see if this value is available for the given MCU).
<code>_PWM_PRESCALER_64</code>	Sets prescaler value to 64.
<code>_PWM_PRESCALER_128</code>	Sets prescaler value to 128 (this value is not available on every MCU. Please use Code Assistant to see if this value is available for the given MCU).

<code>_PWM_PRESCALER_256</code>	Sets prescaler value to 256.
<code>_PWM_PRESCALER_1024</code>	Sets prescaler value to 1024.
<code>_PWM1_PRESCALER_1</code>	Sets prescaler value to 1 on second PWM library (if it exists in Library Manager).
<code>_PWM1_PRESCALER_8</code>	Sets prescaler value to 8 on second PWM library (if it exists in Library Manager).
<code>_PWM1_PRESCALER_32</code>	Sets prescaler value to 32 on second PWM library (if it exists in Library Manager). This value is not available on every MCU. Please use Code Assistant to see if this value is available for the given MCU.
<code>_PWM1_PRESCALER_64</code>	Sets prescaler value to 64 on second PWM library (if it exists in Library Manager).
<code>_PWM1_PRESCALER_128</code>	Sets prescaler value to 128 on second PWM library (if it exists in Library Manager). This value is not available on every MCU. Please use Code Assistant to see if this value is available for the given MCU.
<code>_PWM1_PRESCALER_256</code>	Sets prescaler value to 256 on second PWM library (if it exists in Library Manager).
<code>_PWM1_PRESCALER_1024</code>	Sets prescaler value to 1024 on second PWM library (if it exists in Library Manager).
<code>_PWM_INVERTED</code>	Selects the inverted PWM mode.
<code>_PWM1_INVERTED</code>	Selects the inverted PWM mode on second PWM library (if it exists in Library Manager).
<code>_PWM_NON_INVERTED</code>	Selects the normal (non inverted) PWM mode.
<code>_PWM1_NON_INVERTED</code>	Selects the normal (non inverted) PWM mode on second PWM library (if it exists in Library Manager).

Note: Not all of the MCUs have both PWM and PWM1 library included. Sometimes, like its the case with ATmega8515, MCU has only PWM library. Therefore constants that have in their name PWM1 are invalid (for ATmega8515) and will not be visible from Code Assistant. It is highly advisable to use this feature, since it handles all the constants (available) nad eliminates any chance of typing error.

PWM_Init

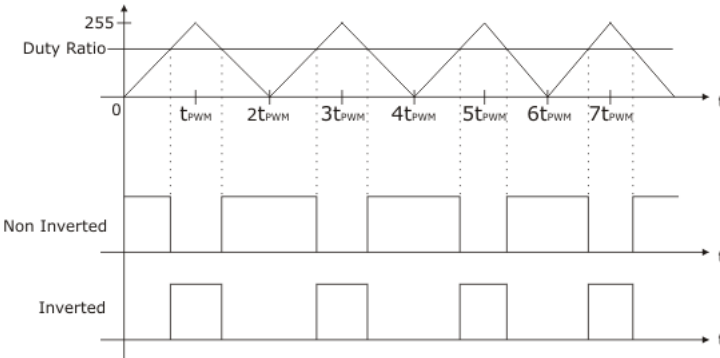
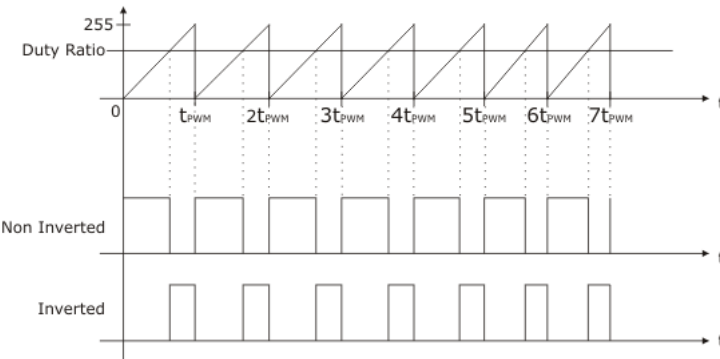
Prototype	<code>sub procedure PWM_Init(dim wave_mode as byte, dim prescaler as byte, dim inverted as byte, dim duty as byte)</code>
Returns	Nothing.
Description	<p>Initializes the PWM module. Parameter <code>wave_mode</code> is a desired PWM mode. There are two modes: Phase Correct and Fast PWM. Parameter <code>prescaler</code> chooses prescale value $N = 1, 8, 64, 256$ or 1024 (some modules support 32 and 128, but for this you will need to check the datasheet for the desired MCU). Parameter <code>inverted</code> is for choosing between inverted and non inverted PWM signal. Parameter <code>duty</code> sets duty ratio from 0 to 255. PWM signal graphs and formulas are shown below.</p> <p style="text-align: center;">PHASE MODE $f_{pwm} = \frac{f_{clk\ i/o}}{N \cdot 510}$</p>  <p style="text-align: center;">FAST MODE $f_{pwm} = \frac{f_{clk\ i/o}}{N \cdot 256}$</p>  <p>PWM_Init must be called before using other functions from PWM Library.</p>

Requires	<p>You need a CMO on the given MCU (that supports PWM).</p> <p>Before calling this routine you must set the output pin for the PWM (according to the datasheet):</p> <pre>DDRB.3 = 1; // set PORTB pin 3 as output for the PWM</pre> <p>This code example is for ATmega16, for different MCU please consult datasheet for the correct pinout of the PWM module or modules.</p>
Example	<p>Initialize PWM module:</p> <pre>PWM_Init(_PWM_FAST_MODE, _PWM_PRESCALER_8, _PWM_NON_INVERTED, 127)</pre>

PWM_Set_Duty

Prototype	<code>sub procedure PWM_Set_Duty(dim duty as byte)</code>
Returns	Nothing.
Description	Changes PWM duty ratio. Parameter duty takes values from 0 to 255, where 0 is 0%, 127 is 50%, and 255 is 100% duty ratio. Other specific values for duty ratio can be calculated as $(\text{Percent} * 255) / 100$.
Requires	PWM module must to be initialised (PWM_Init) before using PWM_Set_Duty function.
Example	<p>For example lets set duty ratio to 75%:</p> <pre>PWM_Set_Duty(192)</pre>

PWM_Start

Prototype	<code>sub procedure PWM_Start()</code>
Returns	Nothing.
Description	Starts PWM.
Requires	MCU must have CMO module to use this library. PWM_Init must be called before using this routine.
Example	<pre>PWM_Start()</pre>

PWM_Stop

Prototype	<code>sub procedure PWM_Stop()</code>
Returns	Nothing.
Description	Stops the PWM.
Requires	MCU must have CMO module to use this library. PWM_Init and PWM_Start must be called before using this routine using this routine, otherwise it will have no effect as the PWM module is not running.
Example	<code>PWM_Stop()</code>

Note: Not all the AVR MCUs support both PWM and PWM1 library. The best way to verify this is by checking the datasheet for the desired MCU. Also you can check this by selecting a MCU in mikroBasic PRO for AVR looking at the Library Manager. If library manager loads both PWM and PWM1 library (you are able to check them) then this MCU supports both PWM libraries. Here you can take full advantage of our Code Assistant and Parameter Assistant feature of our compiler.

PWM1_Init

Prototype	<code>sub procedure PWM1_Init(dim wave_mode as byte, dim prescaler as byte, dim inverted as byte, dim duty as byte)</code>
Returns	Nothing.
Description	<p>Initializes the PWM module. Parameter wave_mode is a desired PWM mode. There are two modes: Phase Correct and Fast PWM. Parameter prescaler chooses prescale value $N = 1, 8, 64, 256$ or 1024 (some modules support 32 and 128, but for this you will need to check the datasheet for the desired MCU). Parameter inverted is for choosing between inverted and non inverted PWM signal. Parameter duty sets duty ratio from 0 to 255. PWM signal graphs and formulas are shown below.</p> <div style="text-align: center;"> <p>PHASE MODE</p> $f_{pwm} = \frac{f_{clk\ i/o}}{N \cdot 510}$ </div>

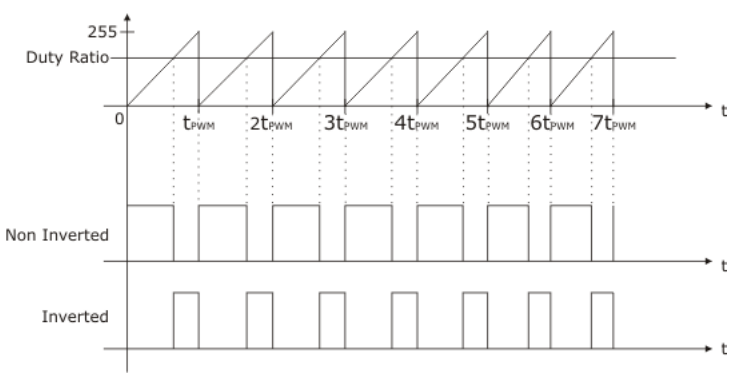
<p>Description</p>	<p style="text-align: center;">FAST MODE</p> $f_{pwm} = \frac{f_{clk\ i/o}}{N \cdot 256}$  <p>The N variable represents the <code>prescaler</code> factor (1, 8, 64, 256, or 1024). Some modules also support 32 and 128 <code>prescaler</code> value, but for this you will need to check the datasheet for the desired MCU)</p> <p>PWM1_Init must be called before using other functions from PWM Library.</p>
<p>Requires</p>	<p>You need a CMO on the given MCU (that supports PWM).</p> <p>Before calling this routine you must set the output pin for the PWM (according to the datasheet):</p> <pre>DDRD.7 = 1; // set PORTD pin 7 as output for the PWM1</pre> <p>This code oxample is for ATmega16 (second PWM module), for different MCU please consult datasheet for the correct pinout of the PWM module or modules.</p>
<p>Example</p>	<p>Initialize PWM module:</p> <pre>PWM1_Init(_PWM1_FAST_MODE, _PWM1_PRESCALER_8, _PWM1_NON_INVERTED, 127)</pre>

PWM1_Set_Duty

Prototype	<code>sub procedure PWM1_Set_Duty(dim duty as byte)</code>
Returns	Nothing.
Description	Changes PWM duty ratio. Parameter <code>duty</code> takes values from 0 to 255, where 0 is 0%, 127 is 50%, and 255 is 100% duty ratio. Other specific values for duty ratio can be calculated as $(\text{Percent} * 255) / 100$.
Requires	PWM module must to be initialised (PWM1_Init) before using PWM_Set_Duty function.
Example	For example lets set duty ratio to 75%: <code>PWM1_Set_Duty(192)</code>

PWM1_Start

Prototype	<code>sub procedure PWM1_Start()</code>
Returns	Nothing.
Description	Starts PWM.
Requires	MCU must have CMO module to use this library. PWM1_Init must be called before using this routine.
Example	<code>PWM1_Start()</code>

PWM1_Stop

Prototype	<code>sub procedure PWM1_Stop()</code>
Returns	Nothing.
Description	Stops the PWM.
Requires	MCU must have CMO module to use this library. PWM1_Init and PWM1_Start must be called before using this routine using this routine, otherwise it will have no effect as the PWM module is not running.
Example	<code>PWM1_Stop();</code>

Library Example

The example changes PWM duty ratio on pin PB3 continually. If LED is connected to PB3, you can observe the gradual change of emitted light.

```

program PWM_Test

dim current_duty as byte
    current_duty1 as byte

main:
    DDB0_bit = 0           ' Set PORTB pin 0 as input
    DDB1_bit = 0           ' Set PORTB pin 1 as input

    DDC0_bit = 0           ' Set PORTC pin 0 as input
    DDC1_bit = 0           ' Set PORTC pin 1 as input

    current_duty = 127     ' initial value for current_duty
    current_duty1 = 127    ' initial value for current_duty

    DDB3_bit = 1           ' Set PORTB pin 3 as output pin
    for the PWM (according to datasheet)
    DDD7_bit = 1           ' Set PORTD pin 7 as output pin
    for the PWM1 (according to datasheet)

    PWM_Init(_PWM_PHASE_CORRECT_MODE,    _PWM_PRESCALER_8,
    _PWM_NON_INVERTED, 127)
    PWM1_Init(_PWM1_PHASE_CORRECT_MODE,   _PWM1_PRESCALER_8,
    _PWM1_NON_INVERTED, 127)

    while TRUE             ' Endless loop

        if (PINB0_bit <> 0) then ' Detect if PORTB pin 0 is pressed
            Delay_ms(40)         ' Small delay to avoid debouncing effect
            Inc(current_duty)     ' Increment duty ratio
            PWM_Set_Duty(current_duty) ' Set incremented duty
        end if

        if (PINB1_bit <> 0) then ' Detect if PORTB pin 1 is pressed
            Delay_ms(40)         ' Small delay to avoid debouncing effect
            Dec(current_duty)     ' Decrement duty ratio
            PWM_Set_Duty(current_duty) ' Set decremented duty ratio
        end if

        if (PINC0_bit <> 0) then ' Detect if PORTC pin 0 is pressed
            Delay_ms(40)         ' Small delay to avoid debouncing effect
            Inc(current_duty1)    ' Increment duty ratio
            PWM1_Set_Duty(current_duty1) ' Set incremented duty
        end if

```

```
if (PINC1_bit <> 0) then ' Detect if PORTC pin 1 is pressed
    Delay_ms(40)          ' Small delay to avoid debouncing effect
    Dec(current_duty1)   ' Decrement duty ratio
    PWM1_Set_Duty(current_duty1) ' Set decremented duty ratio
end if

wend

end.
```

HW Connection

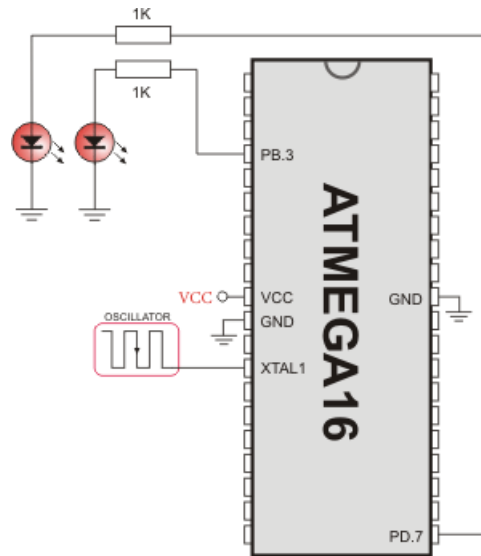

PWM demonstration

PWM 16 BIT LIBRARY

CMO module is available with a number of AVR MCUs. mikroBasic PRO for AVR provides library which simplifies using PWM HW Module.

Note: For better understanding of PWM module it would be best to start with the example provided in Examples folder of our mikroBasic PRO for AVR compiler. When you select a MCU, mikroBasic PRO for AVR automatically loads the correct PWM-16bit library, which can be verified by looking at the Library Manager. PWM library handles and initializes the PWM module on the given AVR MCU, but it is up to user to set the correct pins as PWM output, this topic will be covered later in this section.

Library Routines

- PWM16bit_Init
- PWM16bit_Change_Duty
- PWM16bit_Start
- PWM16bit_Stop

Predefined constants used in PWM-16bit library

The following variables are used in PWM-16bit library functions:	Description:
<code>_PWM16_PHASE_CORRECT_MODE_8BIT</code>	Selects Phase Correct, 8-bit mode.
<code>_PWM16_PHASE_CORRECT_MODE_9BIT</code>	Selects Phase Correct, 9-bit mode.
<code>_PWM16_PHASE_CORRECT_MODE_10BIT</code>	Selects Phase Correct, 10-bit mode.
<code>_PWM16_FAST_MODE_8BIT</code>	Selects Fast, 8-bit mode.
<code>_PWM16_FAST_MODE_9BIT</code>	Selects Fast, 9-bit mode.
<code>_PWM16_FAST_MODE_10BIT</code>	Selects Fast, 10-bit mode.
<code>_PWM16_PRESCALER_16bit_1</code>	Sets prescaler value to 1 (No prescaling).
<code>_PWM16_PRESCALER_16bit_8</code>	Sets prescaler value to 8.
<code>_PWM16_PRESCALER_16bit_64</code>	Sets prescaler value to 64.
<code>_PWM16_PRESCALER_16bit_256</code>	Sets prescaler value to 256.
<code>_PWM16_PRESCALER_16bit_1024</code>	Sets prescaler value to 1024.
<code>_PWM16_INVERTED</code>	Selects the inverted PWM-16bit mode.
<code>_PWM16_NON_INVERTED</code>	Selects the normal (non inverted) PWM-16bit mode.
<code>_TIMER1</code>	Selects the Timer/Counter1 (used with <code>PWM16bit_Start</code> and <code>PWM16bit_Stop</code>).
<code>_TIMER3</code>	Selects the Timer/Counter3 (used with <code>PWM16bit_Start</code> and <code>PWM16bit_Stop</code>).
<code>_TIMER1_CH_A</code>	Selects the channel A on Timer/Counter1 (used with <code>PWM16bit_Change_Duty</code>).
<code>_TIMER1_CH_B</code>	Selects the channel B on Timer/Counter1 (used with <code>PWM16bit_Change_Duty</code>).
<code>_TIMER1_CH_C</code>	Selects the channel C on Timer/Counter1 (used with <code>PWM16bit_Change_Duty</code>).
<code>_TIMER3_CH_A</code>	Selects the channel A on Timer/Counter3 (used with <code>PWM16bit_Change_Duty</code>).
<code>_TIMER3_CH_B</code>	Selects the channel B on Timer/Counter3 (used with <code>PWM16bit_Change_Duty</code>).
<code>_TIMER3_CH_C</code>	Selects the channel C on Timer/Counter3 (used with <code>PWM16bit_sChange_Duty</code>).

Note: Not all of the MCUs have 16bit PWM, and not all of the MCUs have both Timer/Counter1 and Timer/Counter3. Sometimes, like its the case with ATmega168, MCU has only Timer/Counter1 and channels A and B. Therefore constants that have in their name Timer3 or channel C are invalid (for ATmega168) and will not be visible from Code Assistant. It is highly advisable to use this feature, since it handles all the constants (available) and eliminates any chance of typing error.

PWM16bit_Init

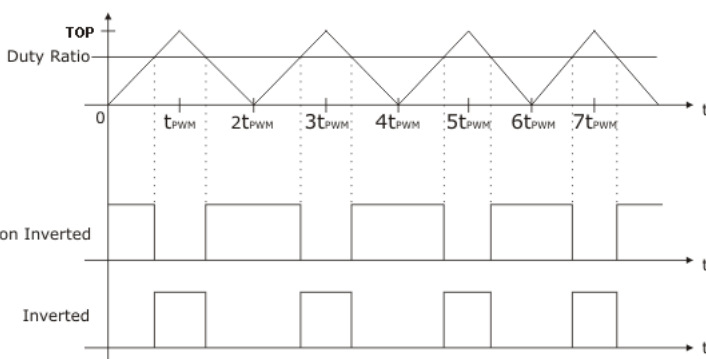
Prototype	<code>sub procedure PWM16bit_Init(dim wave_mode as byte, dim prescaler as byte, dim inverted as byte, dim duty as word, dim timer as byte)</code>
Returns	Nothing.
Description	<p>Initializes the PWM module. Parameter <code>wave_mode</code> is a desired PWM-16bit mode. There are several modes included :</p> <ul style="list-style-type: none"> - PWM, Phase Correct, 8-bit - PWM, Phase Correct, 9-bit - PWM, Phase Correct, 10-bit - Fast PWM, 8-bit - Fast PWM, 9-bit - Fast PWM, 10-bit <p>Parameter <code>prescaler</code> chooses prescale value $N = 1, 8, 64, 256$ or 1024 (some modules support 32 and 128, but for this you will need to check the datasheet for the desired MCU). Parameter <code>inverted</code> is for choosing between inverted and non inverted PWM signal. Parameter <code>duty</code> sets duty ratio from 0 to TOP value (this value varies on the PWM wave mode selected). PWM signal graphs and formulas are shown below.</p> <div style="text-align: center;"> <p>FAST MODE</p> $f_{pwm} = \frac{f_{clk\ i/o}}{N \cdot (1 + TOP)}$ </div>  <p>The diagram illustrates the timing for FAST MODE. It features three vertically aligned plots sharing a common time axis t. The top plot shows the Duty Ratio as a sawtooth wave that ramps up from 0 to TOP and then ramps down. The period of this wave is marked with time intervals t_{PWM} from 0 to $7t_{PWM}$. The middle plot, labeled 'Non Inverted', shows a square wave that is high during the ramp-up phase and low during the ramp-down phase. The bottom plot, labeled 'Inverted', shows a square wave that is low during the ramp-up phase and high during the ramp-down phase.</p>

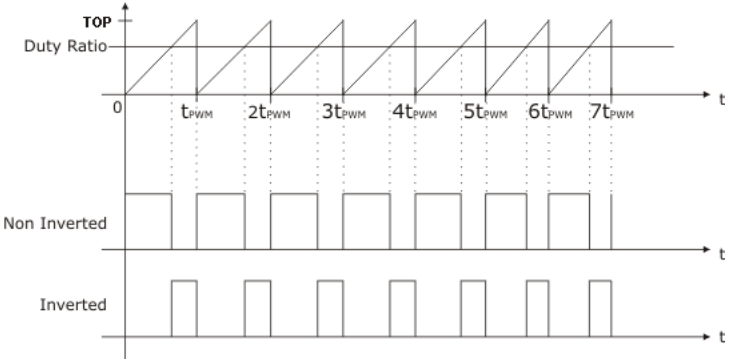
<p>Description</p>	<p style="text-align: center;">PHASE MODE</p> $f_{pwm} = \frac{f_{clk\ i/o}}{2 \cdot N \cdot TOP}$  <p>The N variable represents the <code>prescaler</code> factor (1, 8, 64, 256, or 1024).</p> <p>PWM16bit_Init must be called before using other functions from PWM Library.</p>
<p>Requires</p>	<p>You need a CMO on the given MCU (that supports PWM-16bit).</p> <p>Before calling this routine you must set the output pin for the PWM (according to the datasheet):</p> <pre>DDRB.B1 = 1; // set PORTB pin 1 as output for the PWM-16bit</pre> <p>This code example is for ATmega168, for different MCU please consult datasheet for the correct pinout of the PWM module or modules.</p>
<p>Example</p>	<p>Initialize PWM-16bit module:</p> <pre>PWM16bit_Init(_PWM16_PHASE_CORRECT_MODE_8BIT, _PWM16_PRESCALER_16bit_8, _PWM16_NON_INVERTED, 255, _TIMER1)</pre>

PWM16bit_Change_Duty

Prototype	<code>sub procedure PWM16bit_Change_Duty(dim duty as word, dim channel as byte)</code>			
Returns	Nothing.			
Description	Changes PWM duty ratio. Parameter <code>duty</code> takes values shown on the table below. Where 0 is 0%, and TOP value is 100% duty ratio. Other specific values for duty ratio can be calculated as $(\text{Percent} * \text{TOP}) / 100$.			
	Timer/Counter Mode of Operation :	TOP :	Update of OCRnX at :	TOVn Flag Set on :
	PWM, Phase Correct, 8 bit	0x00FF	TOP	BOTTOM
	PWM, Phase Correct, 9 bit	0x01FF	TOP	BOTTOM
	PWM, Phase Correct, 10 bit	0x03FF	TOP	BOTTOM
	Fast PWM, 8 bit	0x00FF	TOP	TOP
	Fast PWM, 9 bit	0x01FF	TOP	TOP
	Fast PWM, 10 bit	0x03FF	TOP	TOP
Requires	PWM module must to be initialised (PWM16bit_Init) before using PWM_Set_Duty function.			
Example	Example lets set duty ratio to : <code>PWM16bit_Change_Duty(300, _TIMER1_CH_A)</code>			

PWM16bit_Start

Prototype	<code>sub procedure PWM16bit_Start(dim timer as byte)</code>
Returns	Nothing.
Description	Starts PWM-16bit module with already preset values (wave mode, prescaler, inverted and duty) given in the PWM16bit_Init.
Requires	MCU must have CMO module to use this library. PWM16bit_Init must be called before using this routine, otherwise it will have no effect as the PWM module is not initialised.
Example	<pre>PWM16bit_Start(_TIMER1) // Starts the PWM-16bit module on Timer/Counter1 or PWM16bit_Start(_TIMER3) // Starts the PWM-16bit module on Timer/Counter3</pre>

PWM16bit_Stop

Prototype	<code>sub procedure PWM16_Stop(dim timer as byte)</code>
Returns	Nothing.
Description	Stops the PWM-16bit module, connected to Timer/Counter set in this stop function.
Requires	MCU must have CMO module to use this library. Like in PWM16bit_Start before, PWM16bit_Init must be called before using this routine , otherwise it will have no effect as the PWM module is not running.
Example	<pre>PWM16bit_Stop(_TIMER1) // Stops the PWM-16bit module on Timer/Counter1 or PWM16bit_Stop(_TIMER3) // Stops the PWM-16bit module on Timer/Counter3</pre>

Library Example

The example changes PWM duty ratio continually by pressing buttons on PORTC (0-3). If LED is connected to PORTB.B1 or PORTB.B2 ,you can observe the gradual change of emitted light. This example is written for ATmega168. This AVR MCU has only Timer/Counter1 split over two channels A and B. In this example we are changing the duty ratio on both of these channels.

```

program PWM_Test

dim current_duty as byte
    current_duty1 as byte

main:
    DDC0_bit = 0           ' Set PORTC pin 0 as input
    DDC1_bit = 0           ' Set PORTC pin 1 as input

    DDC2_bit = 0           ' Set PORTC pin 2 as input
    DDC3_bit = 0           ' Set PORTC pin 3 as input

    current_duty = 127     ' initial value for current_duty
    current_duty1 = 127   ' initial value for current_duty

    DDB1_bit = 1           ' Set PORTB pin 1 as output pin
    for the PWM (according to datasheet)
    DDB2_bit = 1           ' Set PORTB pin 2 as output pin
    for the PWM (according to datasheet)

    PWM16bit_Init(_PWM16_FAST_MODE_9BIT, _PWM16_PRESCALER_16bit_1,
    _PWM16_INVERTED, 255, 1)

    while TRUE             ' Endless loop

        if (PINC.B0 <> 0) then ' Detect if PORTC pin 0 is pressed
            Delay_ms(40)      ' Small delay to avoid debouncing effect
            Inc(current_duty)  ' Increment duty ratio
            PWM_Set_Duty(current_duty) ' Set incremented duty
        end if

        if (PINC.B1 <> 0) then ' Detect if PORTC pin 1 is pressed
            Delay_ms(40)      ' Small delay to avoid debouncing effect
            Dec(current_duty)  ' Decrement duty ratio
            PWM_Set_Duty(current_duty) ' Set decremented duty ratio
        end if

        if (PINC.B2 <> 0) then ' Detect if PORTC pin 2 is pressed
            Delay_ms(40)      ' Small delay to avoid debouncing effect
            Inc(current_duty1) ' Increment duty ratio
            PWM1_Set_Duty(current_duty1) ' Set incremented duty
        end if

        if (PINC.B3 <> 0) then ' Detect if PORTC pin 3 is pressed
            Delay_ms(40)      ' Small delay to avoid debouncing effect
            Dec(current_duty1) ' Decrement duty ratio
            PWM1_Set_Duty(current_duty1) ' Set decremented duty ratio
        end if

    wend

```

HW Connection

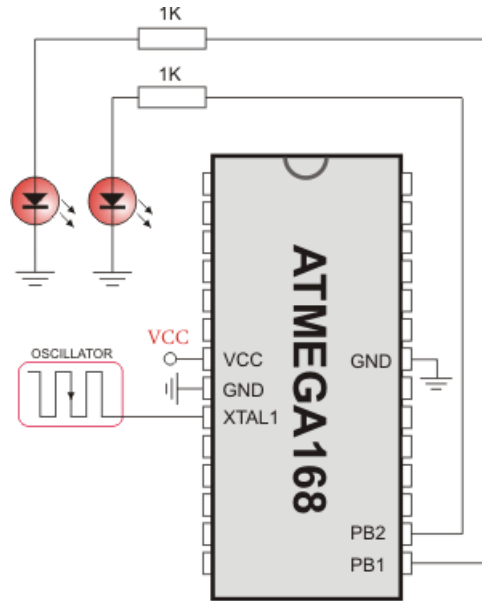

PWM demonstration

RS-485 LIBRARY

RS-485 is a multipoint communication which allows multiple devices to be connected to a single bus. The mikroBasic PRO for AVR provides a set of library routines for comfortable work with RS485 system using Master/Slave architecture. Master and Slave devices interchange packets of information. Each of these packets contains synchronization bytes, CRC byte, address byte and the data. Each Slave has unique address and receives only packets addressed to it. The Slave can never initiate communication.

It is the user's responsibility to ensure that only one device transmits via 485 bus at a time.

The RS-485 routines require the UART module. Pins of UART need to be attached to RS-485 interface transceiver, such as LTC485 or similar (see schematic at the bottom of this page).

Library constants:

- START byte value = 150
- STOP byte value = 169
- Address 50 is the broadcast address for all Slaves (packets containing address 50 will be received by all Slaves except the Slaves with addresses 150 and 169).

Note:

- Prior to calling any of this library routines, UART_Wr_Ptr needs to be initialized with the appropriate UART_Write routine.
- Prior to calling any of this library routines, UART_Rd_Ptr needs to be initialized with the appropriate UART_Read routine.
- Prior to calling any of this library routines, UART_Rdy_Ptr needs to be initialized with the appropriate UART_Ready routine.
- Prior to calling any of this library routines, UART_TX_Idle_Ptr needs to be initialized with the appropriate UART_TX_Idle routine.

External dependencies of RS-485 Library

The following variable must be defined in all projects using RS-485 Library:	Description:	Example :
<code>dim RS485_rxtx_pin as sbit sfr external</code>	Control RS-485 Transmit/Receive operation mode	<code>dim RS485_rxtx_pin as sbit at PORTD.B2</code>
<code>dim RS485_rxtx_pin_direction as sbit sfr external</code>	Direction of the RS-485 Transmit/Receive pin	<code>dim RS485_rxtx_pin_direction as sbit at DDRD.B2</code>

Library Routines

- RS485Master_Init
- RS485Master_Receive
- RS485Master_Send
- RS485Slave_Init
- RS485Slave_Receive
- RS485Slave_Send

RS485Master_Init

Prototype	<code>sub procedure RS485Master_Init()</code>
Returns	Nothing.
Description	Initializes MCU as a Master for RS-485 communication.
Requires	<p>Global variables :</p> <ul style="list-style-type: none"> - <code>RS485_rxtx_pin</code> - this pin is connected to RE/DE input of RS-485 transceiver(see schematic at the bottom of this page). RE/DE signal controls RS-485 transceiver operation mode. - <code>RS485_rxtx_pin_direction</code> - direction of the RS-485 Transmit/Receive pin must be defined before using this function. <p>UART HW module needs to be initialized. See <code>UARTx_Init</code>.</p>
Example	<pre>' RS485 module pinout dim RS485_rxtx_pin as sbit at PORTD.B2 dim RS485_rxtx_pin_direction as sbit at DDRD.B2 ' End of RS485 module pinout ' Pass pointers to UART functions of used UART module UART_Wr_Ptr = @UART1_Write UART_Rd_Ptr = @UART1_Read UART_Rdy_Ptr = @UART1_Data_Ready UART_TX_Idle_Ptr = @UART1_TX_Idle ... UART1_Init(9600) ' initialize UART module RS485Master_Init() ' initialize MCU as a Master for RS-485 communication</pre>

RS485Master_Receive

Prototype	<code>sub procedure RS485Master_Receive (dim byref data_buffer as byte[20])</code>
Returns	Nothing.
Description	<p>Receives messages from Slaves. Messages are multi-byte, so this routine must be called for each byte received.</p> <p>Parameters :</p> <ul style="list-style-type: none"> - <code>data_buffer</code>: 7 byte buffer for storing received data, in the following manner: - <code>data[0..2]</code> : message content - <code>data[3]</code> : number of message bytes received, 1–3 - <code>data[4]</code> : is set to 255 when message is received - <code>data[5]</code> : is set to 255 if error has occurred - <code>data[6]</code> : address of the Slave which sent the message <p>The function automatically adjusts <code>data[4]</code> and <code>data[5]</code> upon every received message. These flags need to be cleared by software.</p>
Requires	MCU must be initialized as a Master for RS-485 communication. See <code>RS485Master_Init</code> .
Example	<pre>dim msg as byte[20] ... RS485Master_Receive(msg)</pre>

RS485Master_Send

Prototype	<code>sub procedure Rs485Master_Send(dim byref data_buffer as byte[20] , dim datalen as byte, dim slave_address as byte)</code>
Returns	Nothing.
Description	<p>Sends message to Slave(s). Message format can be found at the bottom of this page.</p> <p>Parameters :</p> <ul style="list-style-type: none"> - <code>data_buffer</code>: data to be sent - <code>datalen</code>: number of bytes for transmission. Valid values: 0...3. - <code>slave_address</code>: Slave(s) address
Requires	<p>MCU must be initialized as a Master for RS-485 communication. See <code>RS485Master_Init</code>.</p> <p>It is the user's responsibility to ensure (by protocol) that only one device sends data via 485 bus at a time.</p>
Example	<pre>dim msg as byte[20] ... ' send 3 bytes of data to slave with address 0x12 RS485Master_Send(msg, 3, 0x12)</pre>

RS485Slave_Init

Prototype	<code>sub procedure RS485Slave_Init(dim slave_address as byte)</code>
Returns	Nothing.
Description	<p>Initializes MCU as a Slave for RS-485 communication.</p> <p>Parameters :</p> <ul style="list-style-type: none"> - <code>slave_address</code>: Slave address
Requires	<p>Global variables :</p> <ul style="list-style-type: none"> - <code>RS485_rxtx_pin</code> - this pin is connected to RE/DE input of RS-485 transceiver(see schematic at the bottom of this page). RE/DE signal controls RS-485 transceiver operation mode. Valid values: 1 (for transmitting) and 0 (for receiving) - <code>RS485_rxtx_pin_direction</code> - direction of the RS-485 Transmit/Receive pin <p>must be defined before using this function.</p> <p>UART HW module needs to be initialized. See <code>UARTx_Init</code>.</p>
Example	<pre>' RS485 module pinout dim RS485_rxtx_pin as sbit at PORTD.B2 dim RS485_rxtx_pin_direction as sbit at DDRD.B2 ' End of RS485 module pinout ' Pass pointers to UART functions of used UART module UART_Wr_Ptr = @UART1_Write UART_Rd_Ptr = @UART1_Read UART_Rdy_Ptr = @UART1_Data_Ready UART_TX_Idle_Ptr = @UART1_TX_Idle ... UART1_Init(9600) ' initialize UART module RS485Slave_Init(160) ' initialize MCU as a Slave for RS-485 communication with address 160</pre>

RS485Slave_Receive

Prototype	<code>sub procedure RS485Slave_Receive (dim byref data_buffer as byte[20])</code>
Returns	Nothing.
Description	<p>Receives messages from Master. If Slave address and Message address field don't match then the message will be discarded. Messages are multi-byte, so this routine must be called for each byte received.</p> <p>Parameters :</p> <ul style="list-style-type: none"> - <code>data_buffer</code>: 6 byte buffer for storing received data, in the following manner: - <code>data[0..2]</code> : message content - <code>data[3]</code> : number of message bytes received, 1–3 - <code>data[4]</code> : is set to 255 when message is received - <code>data[5]</code> : is set to 255 if error has occurred <p>The function automatically adjusts <code>data[4]</code> and <code>data[5]</code> upon every received message. These flags need to be cleared by software.</p>
Requires	MCU must be initialized as a Slave for RS-485 communication. See <code>RS485Slave_Init</code> .
Example	<pre>dim msg as byte[5] ... RS485Slave_Read(msg)</pre>

RS485Slave_Send

Prototype	<code>sub procedure RS485Slave_Send(dim byref data_buffer as byte[20] , dim datalen as byte)</code>
Returns	Nothing.
Description	Sends message to Master. Message format can be found at the bottom of this page. Parameters : - <code>data_buffer</code> : data to be sent - <code>datalen</code> : number of bytes for transmission. Valid values: 0...3.
Requires	MCU must be initialized as a Slave for RS-485 communication. See RS485Slave_Init. It is the user's responsibility to ensure (by protocol) that only one device sends data via 485 bus at a time.
Example	<pre>dim msg as byte[8] ... ' send 2 bytes of data to the master RS485Slave_Send(msg, 2)</pre>

Library Example

This is a simple demonstration of RS485 Library routines usage.

Master sends message to Slave with address 160 and waits for a response. The Slave accepts data, increments it and sends it back to the Master. Master then does the same and sends incremented data back to Slave, etc.

Master displays received data on P0, while error on receive (0xAA) and number of consecutive unsuccessful retries are displayed on P1. Slave displays received data on P0, while error on receive (0xAA) is displayed on P1. Hardware configurations in this example are made for the EasyAVR5A board and ATmega16.

RS485 Master code:

```

program RS485_Master_Example
dim dat as byte[ 10]           ' buffer for receiving/sending messages
    i, j as byte
    cnt as longint

dim rs485_rxtx_pin as sbit at PORTD.2           ' set transcieve pin
    rs485_rxtx_pin_direction as sbit at DDRD.2   ' set transcieve
pin direction

' Interrupt routine
sub procedure interrupt() org 0x16
    RS485Master_Receive(dat)
end sub

main:
    cnt = 0
    PORTA = 0           ' clear PORTA
    PORTB = 0           ' clear PORTB
    PORTC = 0           ' clear PORTC

    DDRA = 0xFF        ' set PORTA as output
    DDRB = 0xFF        ' set PORTB as output
    DDRC = 0xFF        ' set PORTB as output

' Pass pointers to UART sub functions of used UART module
UART_Wr_Ptr= @UART1_Write
UART_Rd_Ptr = @UART1_Read
UART_Rdy_Ptr = @UART1_Data_Ready
UART_TX_Idle_Ptr = @UART1_TX_Idle

UART1_Init(9600)           ' initialize UART1 module
Delay_ms(100)

RS485Master_Init()        ' initialize MCU as Master
dat[ 0] = 0xAA
dat[ 1] = 0xF0
dat[ 2] = 0x0F
dat[ 4] = 0               ' ensure that message received flag is 0
dat[ 5] = 0               ' ensure that error flag is 0
dat[ 6] = 0

RS485Master_Send(dat,1,160)

SREG_I_bit = 1           ' enable global interrupt
RXCIE_bit = 1           ' enable interrupt on UART receive

while TRUE
    Inc(cnt)
    if (dat[ 5] <> 0) then           ' if an error detected, signal it
        PORTC = dat[ 5]             ' by setting PORTC
    end if

```

```

if (dat[ 4] <> 0) then          ' if message received successfully
    cnt = 0
    dat[ 4] = 0                  ' clear message received flag
    j = dat[ 3]
    for i = 1 to dat[ 3]        ' show data on PORTB
        PORTB = dat[ i-1]
    next i
    dat[ 0] = dat[ 0]+1         ' increment received dat[ 0]
    Delay_ms(1)                ' send back to slave
    RS485Master_Send(dat,1,160)
end if

if (cnt > 100000) then      ' if in 100000 poll-cycles the answer
    Inc(PORTA)                  ' was not detected, signal
    cnt = 0                     ' failure of send-message
    RS485Master_Send(dat,1,160)
    if (PORTA > 10) then      ' if sending failed 10 times
        PORTA = 0
        RS485Master_Send(dat,1,50) ' send message on broadcast
address
    end if
    end if
wend
end.

```

RS485 Slave code:

```

program RS485_Slave_Example

dim dat as byte[ 20]        ' buffer for receving/sending
messages
    i, j as byte

dim rs485_rxtx_pin as sbit at PORTD.B2 ' set transcieve pin
    rs485_rxtx_pin_direction as sbit at DDRD.B2 ' set transcieve
pin direction

' Interrupt routine
sub procedure interrupt() org 0x16
    RS485Slave_Receive(dat)
end sub

main:
    PORTB = 0                  ' clear PORTB
    PORTC = 0                  ' clear PORTC

    DDRB = 0xFF               ' set PORTB as output
    DDRC = 0xFF               ' set PORTB as output

```



```
' Pass pointers to UART sub functions of used UART module
UART_Wr_Ptr = @UART1_Write
UART_Rd_Ptr = @UART1_Read
UART_Rdy_Ptr = @UART1_Data_Ready
UART_TX_Idle_Ptr = @UART1_TX_Idle

UART1_Init(9600)      ' initialize UART1 module
Delay_ms(100)
RS485Slave_Init(160) ' Intialize MCU as slave, address 160

dat[ 4] = 0          ' ensure that message received flag is 0
dat[ 5] = 0          ' ensure that message received flag is 0
dat[ 6] = 0          ' ensure that error flag is 0

SREG_I_bit  = 1      ' enable global interrupt
RXCIE_bit   = 1      ' enable interrupt on UARTs receive

while TRUE
  if (dat[ 5] <> 0) then ' if an error detected, signal it by
    PORTC = dat[ 5]     ' setting PORTC
    dat[ 5] = 0
  end if
  if (dat[ 4] <> 0) then ' upon completed valid message receive
    dat[ 4] = 0         ' data[ 4] is set to 0xFF
    j = dat[ 3]
    for i = 1 to dat[ 3] ' show data on PORTB
      PORTB = dat[ i-1]
    next i
    dat[ 0] = dat[ 0] +1 ' increment received dat[ 0]
    Delay_ms(1)
    RS485Slave_Send(dat,1) ' and send it back to master
  end if
wend
end.
```

HW Connection

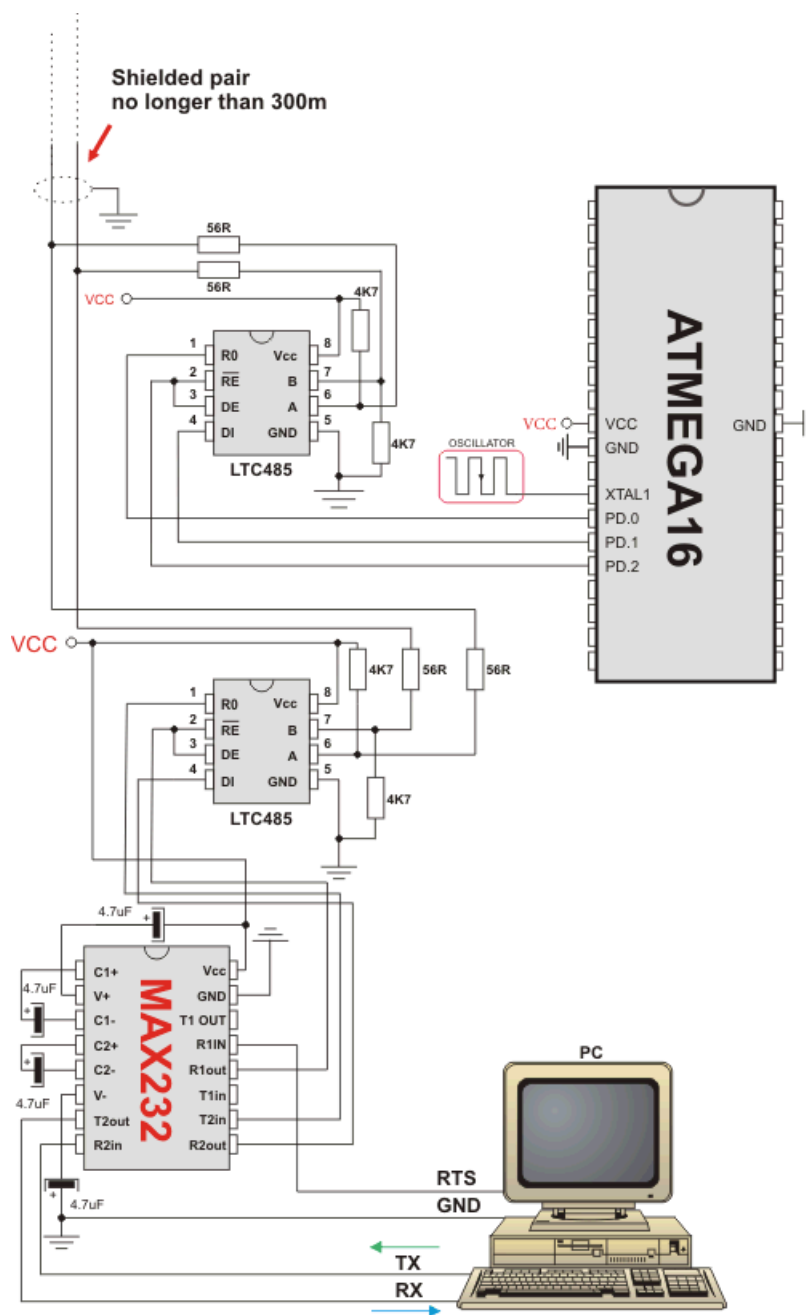

Example of interfacing PC to ATmega16 MCU via RS485 bus with LTC485 as RS-485 transceiver

Message format and CRC calculations

Q: How is CRC checksum calculated on RS485 master side?

```

START_BYTE = 0x96; ' 10010110
STOP_BYTE  = 0xA9; ' 10101001

```

```

PACKAGE:
-----

```

```

START_BYTE 0x96
ADDRESS
DATALEN
[ DATA1]           ' if exists
[ DATA2]           ' if exists
[ DATA3]           ' if exists
CRC
STOP_BYTE  0xA9

```

```

DATALEN bits
-----

```

```

bit7 = 1  MASTER SENDS
        0  SLAVE  SENDS

bit6 = 1  ADDRESS WAS XORed with 1, IT WAS EQUAL TO START_BYTE or
STOP_BYTE
        0  ADDRESS UNCHANGED

bit5 = 0  FIXED

bit4 = 1  DATA3 (if exists) WAS XORed with 1, IT WAS EQUAL TO
START_BYTE or STOP_BYTE
        0  DATA3 (if exists) UNCHANGED

bit3 = 1  DATA2 (if exists) WAS XORed with 1, IT WAS EQUAL TO
START_BYTE or STOP_BYTE
        0  DATA2 (if exists) UNCHANGED

bit2 = 1  DATA1 (if exists) WAS XORed with 1, IT WAS EQUAL TO
START_BYTE or STOP_BYTE
        0  DATA1 (if exists) UNCHANGED

bit1bit0 = 0 to 3 NUMBER OF DATA BYTES SEND

```

```

CRC generation :
-----

```

```

crc_send = datalen ^ address;
crc_send ^= data[ 0];      ' if exists
crc_send ^= data[ 1];      ' if exists
crc_send ^= data[ 2];      ' if exists
crc_send = ~crc_send;
if ((crc_send == START_BYTE) || (crc_send == STOP_BYTE))
    crc_send++;

```

```

NOTE:  DATALEN<4..0> can not take the START_BYTE<4..0> or
STOP_BYTE<4..0> values.

```

SOFTWARE I²C LIBRARY

The mikroBasic PRO for AVR provides routines for implementing Software I²C communication. These routines are hardware independent and can be used with any MCU. The Software I²C library enables you to use MCU as Master in I²C communication. Multi-master mode is not supported.

Note: This library implements time-based activities, so interrupts need to be disabled when using Software I²C.

Note: All Software I²C Library functions are blocking-call functions (they are waiting for I²C clock line to become logical one).

Note: The pins used for Software I²C communication should be connected to the pull-up resistors. Turning off the LEDs connected to these pins may also be required.

External dependencies of Soft_I2C Library

The following variables must be defined in all projects using Soft_I2C Library:	Description:	Example :
<code>dim Soft_I2C_Scl_Output as sbit sfr external</code>	Soft I ² C Clock output line.	<code>dim Soft_I2C_Scl_Output as sbit at PORTC.B0</code>
<code>dim Soft_I2C_Sda_Output as sbit sfr external</code>	Soft I ² C Data output line.	<code>dim Soft_I2C_Sda_Output as sbit at PORTC.B1</code>
<code>dim Soft_I2C_Scl_Input as sbit sfr external</code>	Soft I ² C Clock input line.	<code>dim Soft_I2C_Scl_Input as sbit at PINC.B0</code>
<code>dim Soft_I2C_Sda_Input as sbit sfr external</code>	Soft I ² C Data input line.	<code>dim Soft_I2C_Sda_Input as sbit at PINC.B1</code>
<code>dim Soft_I2C_Scl_Pin_Direction as sbit sfr external</code>	Direction of the Soft I ² C Clock pin.	<code>dim Soft_I2C_Scl_Pin_Direction as sbit at DDRC.B0</code>
<code>dim Soft_I2C_Sda_Pin_Direction as sbit sfr external</code>	Direction of the Soft I ² C Data pin.	<code>dim Soft_I2C_Sda_Pin_Direction as sbit at DDRC.B1</code>

Library Routines

- Soft_I2C_Init
- Soft_I2C_Start
- Soft_I2C_Read
- Soft_I2C_Write
- Soft_I2C_Stop
- Soft_I2C_Break

Soft_I2C_Init

Prototype	<code>sub procedure Soft_I2C_Init()</code>
Returns	Nothing.
Description	Configures the software I ² C module.
Requires	<p>Global variables :</p> <ul style="list-style-type: none"> - <code>Soft_I2C_Scl_Output</code>: Soft I²C clock output line - <code>Soft_I2C_Sda_Output</code>: Soft I²C data output line - <code>Soft_I2C_Scl_Input</code>: Soft I²C clock input line - <code>Soft_I2C_Sda_Input</code>: Soft I²C data input line - <code>Soft_I2C_Scl_Pin_Direction</code>: Direction of the Soft I²C clock pin - <code>Soft_I2C_Sda_Pin_Direction</code>: Direction of the Soft I²C data pin <p>must be defined before using this function.</p>
Example	<pre>'Soft_I2C pinout definition dim Soft_I2C_Scl_Output as sbit at PORTC.B0 dim Soft_I2C_Sda_Output as sbit at PORTC.B1 dim Soft_I2C_Scl_Input as sbit at PINC.B0 dim Soft_I2C_Sda_Input as sbit at PINC.B1 dim Soft_I2C_Scl_Pin_Direction as sbit at DDRC.B0 dim Soft_I2C_Sda_Pin_Direction as sbit at DDRC.B1 'End of Soft_I2C pinout definition ... Soft_I2C_Init()</pre>

Soft_I2C_Start

Prototype	<code>sub procedure Soft_I2C_Start()</code>
Returns	Nothing.
Description	Determines if the I ² C bus is free and issues START signal.
Requires	Software I ² C must be configured before using this function. See Soft_I2C_Init routine.
Example	<pre>' Issue START signal Soft_I2C_Start()</pre>

Soft_I2C_Read

Prototype	<code>sub function Soft_I2C_Read(dim ack as word) as byte</code>
Returns	One byte from the Slave.
Description	<p>Reads one byte from the slave.</p> <p>Parameters :</p> <ul style="list-style-type: none"> - <code>ack</code>: acknowledge signal parameter. If the <code>ack==0</code> not acknowledge signal will be sent after reading, otherwise the acknowledge signal will be sent.
Requires	<p>Soft I²C must be configured before using this function. See Soft_I2C_Init routine.</p> <p>Also, START signal needs to be issued in order to use this function. See Soft_I2C_Start routine.</p>
Example	<pre>dim take as word ... ' Read data and send the not_acknowledge signal take = Soft_I2C_Read(0)</pre>

Soft_I2C_Write

Prototype	<code>sub function Soft_I2C_Write(dim _Data as byte) as byte</code>
Returns	<ul style="list-style-type: none"> - 0 if there were no errors. - 1 if write collision was detected on the I²C bus.
Description	<p>Sends data byte via the I₂C bus.</p> <p>Parameters :</p> <ul style="list-style-type: none"> - <code>_Data</code>: data to be sent
Requires	<p>Soft I²C must be configured before using this function. See <code>Soft_I2C_Init</code> routine.</p> <p>Also, START signal needs to be issued in order to use this function. See <code>Soft_I2C_Start</code> routine.</p>
Example	<pre>dim _data, error as byte ... error = Soft_I2C_Write(data) error = Soft_I2C_Write(0xA3)</pre>

Soft_I2C_Stop

Prototype	<code>sub procedure Soft_I2C_Stop()</code>
Returns	Nothing.
Description	Issues STOP signal.
Requires	Soft I ² C must be configured before using this function. See <code>Soft_I2C_Init</code> routine.
Example	<pre>' Issue STOP signal Soft_I2C_Stop()</pre>

Soft_I2C_Break

Prototype	<code>sub procedure Soft_I2C_Break()</code>
Returns	Nothing.
Description	<p>All Software I²C Library functions can block the program flow (see note at the top of this page). Call this routine from interrupt to unblock the program execution. This mechanism is similar to WDT.</p> <p>Note: Interrupts should be disabled before using Software I₂C routines again (see note at the top of this page).</p>
Requires	Nothing.
Example	<pre>'Soft_I2C pinout definition dim Soft_I2C_Scl_Output as sbit at PORTC.B0 dim Soft_I2C_Sda_Output as sbit at PORTC.B1 dim Soft_I2C_Scl_Input as sbit at PINC.B0 dim Soft_I2C_Sda_Input as sbit at PINC.B1 dim Soft_I2C_Scl_Pin_Direction as sbit at DDRC.B0 dim Soft_I2C_Sda_Pin_Direction as sbit at DDRC.B1 'End of Soft_I2C pinout definition dim counter as byte sub procedure Timer0Overflow_ISR() org 0x12 counter = 0 if (counter >= 20) then Soft_I2C_Break() counter = 0 'reset counter else Inc(counter) 'increment counter end if end sub main: TOIE0_bit = 1 'Timer0 overflow interrupt enable TCCR0_bit = 5 'Start timer with 1024 prescaler SREG_I_bit = 0 'Interrupt disable ... 'try Soft_I2C_Init with blocking prevention mechanism SREG_I_bit = 1 'Interrupt enable Soft_I2C_Init() SREG_I_bit = 0 'Interrupt disable ... end.</pre>

Library Example

The example demonstrates Software I₂C Library routines usage. The AVR MCU is connected (SCL, SDA pins) to PCF8583 RTC (real-time clock). Program reads date and time are read from the RTC and prints it on Lcd.

```

program RTC_Read

dim seconds, minutes, hours, _day, _month, year as byte      ' Global
date/time variables

' Software I2C connections
dim Soft_I2C_Scl_Output    as sbit at PORTC.B0
      Soft_I2C_Sda_Output    as sbit at PORTC.B1
      Soft_I2C_Scl_Input     as sbit at PINC.B0
      Soft_I2C_Sda_Input     as sbit at PINC.B1
      Soft_I2C_Scl_Direction as sbit at DDRC.B0
      Soft_I2C_Sda_Direction as sbit at DDRC.B1
' End Software I2C connections

' Lcd module connections
dim LCD_RS as sbit at PORTD.B2
      LCD_EN as sbit at PORTD.B3
      LCD_D4 as sbit at PORTD.B4
      LCD_D5 as sbit at PORTD.B5
      LCD_D6 as sbit at PORTD.B6
      LCD_D7 as sbit at PORTD.B7
      LCD_RS_Direction as sbit at DDRD.B2
      LCD_EN_Direction as sbit at DDRD.B3
      LCD_D4_Direction as sbit at DDRD.B4
      LCD_D5_Direction as sbit at DDRD.B5
      LCD_D6_Direction as sbit at DDRD.B6
      LCD_D7_Direction as sbit at DDRD.B7
' End Lcd module connections

'----- Reads time and date information from RTC
(PCF8583)
sub procedure Read_Time()
  Soft_I2C_Start()          ' Issue start signal
  Soft_I2C_Write(0xA0)     ' Address PCF8583, see PCF8583 datasheet
  Soft_I2C_Write(2)        ' Start from address 2
  Soft_I2C_Start()         ' Issue repeated start signal
  Soft_I2C_Write(0xA1)     ' Address PCF8583 for reading R/W=1
  seconds = Soft_I2C_Read(1) ' Read seconds byte
  minutes = Soft_I2C_Read(1) ' Read minutes byte
  hours = Soft_I2C_Read(1)  ' Read hours byte
  _day = Soft_I2C_Read(1)   ' Read year/day byte
  _month = Soft_I2C_Read(0) ' Read weekday/month byte)
  Soft_I2C_Stop()          ' Issue stop signal)
end sub

```

```
'----- Formats date and time
sub procedure Transform_Time()
    seconds = ((seconds and 0xF0) >> 4)*10 + (seconds and 0x0F) '
Transform seconds
    minutes = ((minutes and 0xF0) >> 4)*10 + (minutes and 0x0F) '
Transform months
    hours = ((hours and 0xF0) >> 4)*10 + (hours and 0x0F) '
Transform hours
    year = (_day and 0xC0) >> 6 '
Transform year
    _day = ((_day and 0x30) >> 4)*10 + (_day and 0x0F) '
Transform day
    _month = ((_month and 0x10) >> 4)*10 + (_month and 0x0F) '
Transform month
end sub

'----- Output values to Lcd
sub procedure Display_Time()
    Lcd_Chr(1, 6, (_day / 10) + 48) ' Print tens digit of day
variable
    Lcd_Chr(1, 7, (_day mod 10) + 48) ' Print oness digit of day
variable
    Lcd_Chr(1, 9, (_month / 10) + 48)
    Lcd_Chr(1,10, (_month mod 10) + 48)
    Lcd_Chr(1,15, year + 56) ' Print year variable + 8
(start from year 2008)
    Lcd_Chr(2, 6, (hours / 10) + 48)
    Lcd_Chr(2, 7, (hours mod 10) + 48)
    Lcd_Chr(2, 9, (minutes / 10) + 48)
    Lcd_Chr(2,10, (minutes mod 10) + 48)
    Lcd_Chr(2,12, (seconds / 10) + 48)
    Lcd_Chr(2,13, (seconds mod 10) + 48)
end sub

'----- Performs project-wide init
sub procedure Init_Main()
    Soft_I2C_Init() ' Initialize Soft I2C communication
    Lcd_Init() ' Initialize Lcd
    Lcd_Cmd(LCD_CLEAR) ' Clear Lcd display
    Lcd_Cmd(LCD_CURSOR_OFF) ' Turn cursor off
    Lcd_Out(1,1,"Date:") ' Prepare and output static text on Lcd
    Lcd_Chr(1,8,":")
    Lcd_Chr(1,11,":")
    Lcd_Out(2,1,"Time:")
    Lcd_Chr(2,8,":")
    Lcd_Chr(2,11,":")
    Lcd_Out(1,12,"200")
end sub
```

```
'----- Main sub procedure
main:
  Init_Main()           ' Perform initialization

  while TRUE           ' Endless loop
    Read_Time()        ' Read time from RTC(PCF8583)
    Transform_Time()   ' Format date and time
    Display_Time()     ' Prepare and display on Lcd
  wend
end.
```

SOFTWARE SPI LIBRARY

The mikroBasic PRO for AVR provides routines for implementing Software SPI communication. These routines are hardware independent and can be used with any MCU. The Software SPI Library provides easy communication with other devices via SPI: A/D converters, D/A converters, MAX7219, LTC1290, etc.

Library configuration:

- SPI to Master mode
- Clock value = 20 kHz.
- Data sampled at the middle of interval.
- Clock idle state low.
- Data sampled at the middle of interval.
- Data transmitted at low to high edge.

Note: The Software SPI library implements time-based activities, so interrupts need to be disabled when using it.

External dependencies of Software SPI Library

The following variables must be defined in all projects using Software SPI Library:	Description:	Example :
<code>dim Chip_Select as sbit sfr external</code>	Chip select line.	<code>dim Chip_Select as sbit at PORTB.B0</code>
<code>dim SoftSpi_SDI as sbit sfr external</code>	Data In line.	<code>dim SoftSpi_SDI as sbit at PINB.B6</code>
<code>dim SoftSpi_SDO as sbit sfr external</code>	Data Out line.	<code>dim SoftSpi_SDO as sbit at PORTB.B5</code>
<code>dim SoftSpi_CLK as sbit sfr external</code>	Clock line.	<code>dim SoftSpi_CLK as sbit at PORTB.B7</code>
<code>dim Chip_Select_Direction as sbit sfr external</code>	Direction of the Chip Select pin.	<code>dim Chip_Select_Direction as sbit at DDRB.B0</code>
<code>dim SoftSpi_SDI_Direction as sbit sfr external</code>	Direction of the Data In pin.	<code>dim SoftSpi_SDI_Direction as sbit at DDRB.B6</code>
<code>dim SoftSpi_SDO_Direction as sbit sfr external</code>	Direction of the Data Out pin	<code>dim SoftSpi_SDO_Direction as sbit at DDRB.B5</code>
<code>dim SoftSpi_CLK_Direction as sbit sfr external</code>	Direction of the Clock pin.	<code>dim SoftSpi_CLK_Direction as sbit at DDRB.B7</code>

Library Routines

- Soft_SPI_Init
- Soft_SPI_Read
- Soft_SPI_Write

Soft_SPI_Init

Prototype	<code>sub procedure Soft_SPI_Init()</code>
Returns	Nothing.
Description	Configures and initializes the software SPI module.
Requires	<p>Global variables:</p> <ul style="list-style-type: none"> - <code>Chip_Select</code>: Chip select line - <code>SoftSpi_SDI</code>: Data in line - <code>SoftSpi_SDO</code>: Data out line - <code>SoftSpi_CLK</code>: Data clock line - <code>Chip_Select_Direction</code>: Direction of the Chip select pin - <code>SoftSpi_SDI_Direction</code>: Direction of the Data in pin - <code>SoftSpi_SDO_Direction</code>: Direction of the Data out pin - <code>SoftSpi_CLK_Direction</code>: Direction of the Data clock pin <p>must be defined before using this function.</p>
Example	<pre>' soft_spi pinout definition dim Chip_Select as sbit at PORTB.B0 dim SoftSpi_SDI as sbit at PINB.B6 dim SoftSpi_SDO as sbit at PORTB.B5 dim SoftSpi_CLK as sbit at PORTB.B7 dim Chip_Select_Direction as sbit at DDRB.B0 dim SoftSpi_SDI_Direction as sbit at DDRB.B6 dim SoftSpi_SDO_Direction as sbit at DDRB.B5 dim SoftSpi_CLK_Direction as sbit at DDRB.B7 ' end of soft_spi pinout definition ... Soft_SPI_Init() ' Init Soft_SPI</pre>

Soft_SPI_Read

Prototype	<code>sub function Soft_SPI_Read(dim sdata as byte) as word</code>
Returns	Byte received via the SPI bus.
Description	This routine performs 3 operations simultaneously. It provides clock for the Software SPI bus, reads a byte and sends a byte. Parameters : - <code>sdata</code> : data to be sent.
Requires	Soft SPI must be initialized before using this function. See <code>Soft_SPI_Init</code> routine.
Example	<pre>dim data_read as byte data_send as byte ... ' Read a byte and assign it to data_read variable ' (data_send byte will be sent via SPI during the Read operation) data_read = Soft_SPI_Read(data_send)</pre>

Soft_SPI_Write

Prototype	<code>sub procedure Soft_SPI_Write(dim sdata as byte)</code>
Returns	Nothing.
Description	This routine sends one byte via the Software SPI bus. Parameters : - <code>sdata</code> : data to be sent.
Requires	Soft SPI must be initialized before using this function. See <code>Soft_SPI_Init</code> routine.
Example	<pre>' Write a byte to the Soft SPI bus Soft_SPI_Write(0xAA)</pre>

Library Example

This code demonstrates using library routines for Soft_SPI communication. Also, this example demonstrates working with Microchip's MCP4921 12-bit D/A converter.

```

program Soft_SPI
' DAC module connections
dim Chip_Select as sbit at PORTB.0
    SoftSpi_CLK as sbit at PORTB.7
    SoftSpi_SDI as sbit at PINB.6    ' Note: Input signal
    SoftSpi_SDO as sbit at PORTB.5

dim Chip_Select_Direction as sbit at DDRB.0
    SoftSpi_CLK_Direction as sbit at DDRB.7
    SoftSpi_SDI_Direction as sbit at DDRB.6
    SoftSpi_SDO_Direction as sbit at DDRB.5
' End DAC module connections

dim value as word

sub procedure InitMain()
    DDA0_bit = 0                ' Set PA0 pin as input
    DDA1_bit = 0                ' Set PA1 pin as input
    Chip_Select = 1            ' Deselect DAC
    Chip_Select_Direction = 1  ' Set CS# pin as Output
    SoftSpi_Init()            ' Initialize Soft_SPI
end sub

' DAC increments (0..4095) --> output voltage (0..Vref)
sub procedure DAC_Output(dim valueDAC as word)
dim temp as byte
    Chip_Select = 0            ' Select DAC chip
    ' Send High Byte
    temp = word(valueDAC >> 8) and 0x0F    ' Store valueDAC[ 11..8] to
temp[ 3..0]

    temp = temp or 0x30        ' Define DAC setting, see
MCP4921 datasheet
    Soft_SPI_Write(temp)      ' Send high byte via Soft SPI

    ' Send Low Byte
    temp = valueDAC            ' Store valueDAC[ 7..0] to temp[ 7..0]
    Soft_SPI_Write(temp)      ' Send low byte via Soft SPI

    Chip_Select = 1            ' Deselect DAC chip
end sub

main:
    InitMain()                ' Perform main initialization

```

```
value = 2048                                ' When program starts, DAC gives
                                           '   the output in the mid-range
while (TRUE)                                ' Endless loop
  if ((PINA0_bit) and (value < 4095)) then  ' If PA0 button is
pressed
    Inc(value)                              '   increment value
  else
    if ((PINA1_bit) and (value > 0)) then  ' If PA1 button is
pressed
      Dec(value)                            '   decrement value
    end if
  end if

  DAC_Output(value)                        ' Send value to DAC chip
  Delay_ms(1)                             ' Slow down key repeat pace
wend
end.
```

SOFTWARE UART LIBRARY

The mikroBasic PRO for AVR provides routines for implementing Software UART communication. These routines are hardware independent and can be used with any MCU. The Software UART Library provides easy communication with other devices via the RS232 protocol.

Note: The Software UART library implements time-based activities, so interrupts need to be disabled when using it.

External dependencies of Software UART Library

The following variables must be defined in all projects using Software UART Library:	Description:	Example :
<code>dim Soft_UART_Rx_Pin as sbit sfr external</code>	Receive line.	<code>dim Soft_UART_Rx_Pin as sbit at PIND.B0</code>
<code>dim Soft_UART_Tx_Pin as sbit sfr external</code>	Transmit line.	<code>dim Soft_UART_Tx_Pin as sbit at PORTD.B1</code>
<code>dim Soft_UART_Rx_Pin_Direction as sbit sfr external</code>	Direction of the Receive pin.	<code>dim Soft_UART_Rx_Pin_Direction as sbit at DDRD.B0</code>
<code>dim Soft_UART_Tx_Pin_Direction as sbit sfr external</code>	Direction of the Transmit pin.	<code>dim Soft_UART_Tx_Pin_Direction as sbit at DDRD.B1</code>

Library Routines

- Soft_UART_Init
- Soft_UART_Read
- Soft_UART_Write
- Soft_UART_Break

Soft_UART_Init

Prototype	<code>sub function Soft_UART_Init(dim baud_rate as longword, dim inverted as byte) as byte</code>
Returns	<ul style="list-style-type: none"> - 2 - error, requested baud rate is too low - 1 - error, requested baud rate is too high - 0 - successfull initialization
Description	<p>Configures and initializes the software UART module.</p> <p>Parameters :</p> <ul style="list-style-type: none"> - <code>baud_rate</code>: baud rate to be set. Maximum baud rate depends on the MCU's clock and working conditions. - <code>inverted</code>: inverted output flag. When set to a non-zero value, inverted logic on output is used. <p>Software UART routines use Delay_Cyc routine. If requested baud rate is too low then calculated parameter for calling Delay_Cyc exceeds Delay_Cyc argument range.</p> <p>If requested baud rate is too high then rounding error of Delay_Cyc argument corrupts Software UART timings.</p>
Requires	<p>Global variables:</p> <ul style="list-style-type: none"> - <code>Soft_UART_Rx_Pin</code>: Receiver pin - <code>Soft_UART_Tx_Pin</code>: Transmitter pin - <code>Soft_UART_Rx_Pin_Direction</code>: Direction of the Receiver pin - <code>Soft_UART_Tx_Pin_Direction</code>: Direction of the Transmitter pin <p>must be defined before using this function.</p>
Example	<pre>' Soft UART connections dim Soft_UART_Rx_Pin as sbit at PIND.B0 dim Soft_UART_Tx_Pin as sbit at PORTD.B1 dim Soft_UART_Rx_Pin_Direction as sbit at DDRD.B0 dim Soft_UART_Tx_Pin_Direction as sbit at DDRD.B1 ' Soft UART connections ' Initialize Software UART communication on pins Rx, Tx, at 9600 bps Soft_UART_Init(9600, 0)</pre>

Soft_UART_Read

Prototype	<code>sub function Soft_UART_Read(dim byref error as byte) as byte</code>
Returns	Byte received via UART.
Description	<p>The function receives a byte via software UART.</p> <p>This is a blocking function call (waits for start bit). Programmer can unblock it by calling <code>Soft_UART_Break</code> routine.</p> <p>Parameters :</p> <ul style="list-style-type: none"> - <code>error</code>: Error flag. Error code is returned through this variable. - 0 - no error - 1 - stop bit error - 255 - user abort, <code>Soft_UART_Break</code> called
Requires	Software UART must be initialized before using this function. See the <code>Soft_UART_Init</code> routine.
Example	<pre> dim data as byte error as byte ... ' wait until data is received do data = Soft_Uart_Read(error) loop until (error = 0) ' Now we can work with data: if (data) then ... end if </pre>

Soft_UART_Write

Prototype	<code>sub procedure Soft_UART_Write(udata as byte)</code>
Returns	Nothing.
Description	<p>This routine sends one byte via the Software UART bus.</p> <p>Parameters :</p> <p>- <code>udata</code>: data to be sent.</p>
Requires	<p>Software UART must be initialized before using this function. See the <code>Soft_UART_Init</code> routine.</p> <p>Be aware that during transmission, software UART is incapable of receiving data – data transfer protocol must be set in such a way to prevent loss of information.</p>
Example	<pre>dim some_byte as byte ... ' Write a byte via Soft Uart some_byte = 0x0A Soft_Uart_Write(some_byte)</pre>

Soft_UART_Break

Prototype	<code>sub procedure Soft_UART_Break()</code>
Returns	Nothing.
Description	<p>Soft_UART_Read is blocking routine and it can block the program flow. Call this routine from interrupt to unblock the program execution. This mechanism is similar to WDT.</p> <p>Note: Interrupts should be disabled before using Software UART routines again (see note at the top of this page).</p>
Requires	Nothing.
Example	<pre> dim data1, error, counter as byte sub procedure Timer0Overflow_ISR() org 0x12 counter = 0 if (counter >= 20) then Soft_UART_Break() counter = 0 ' reset counter else Inc(counter) ' increment counter end if end sub main: TOIE0_bit = 1 ' Timer0 overflow interrupt enable TCCR0_bit = 5 ' Start timer with 1024 prescaler SREG_I_bit = 0 ' Interrupt disable ... Soft_UART_Init(9600) Soft_UART_Write(0x55) ... ' try Soft_UART_Read with blocking prevention mechanism SREG_I_bit = 1 ' Interrupt enable data1 = Soft_UART_Read(&error) SREG_I_bit = 0 ' Interrupt disable ... end. </pre>

Library Example

This example demonstrates simple data exchange via software UART. If MCU is connected to the PC, you can test the example from the mikroBasic PRO for AVR USART Terminal Tool.

```
program Soft_UART

' Soft UART connections
dim Soft_UART_Rx_Pin as sbit at PIND.B0
    Soft_UART_Tx_Pin as sbit at PORTD.B1
    Soft_UART_Rx_Pin_Direction as sbit at DDRD.B0
    Soft_UART_Tx_Pin_Direction as sbit at DDRD.B1
' End Soft UART connections

dim error_, counter, byte_read as byte ' Auxiliary variables

main:
    DDRB = 0xFF          ' Set PORTB as output (error signalization)
    PORTB = 0            ' No error

    error_ = Soft_UART_Init(9600, 0) ' Initialize Soft UART at 9600 bps
    if (error_ > 0) then
        PORTB = error_          ' Signalize Init error
        while TRUE
            nop                  ' Stop program
        wend
    end if
    Delay_ms(100)

    for counter = "z" to "A" step -1 ' Send bytes from 'z' downto 'A'
        Soft_UART_Write(counter)
        Delay_ms(100)
    next counter

    while TRUE ' Endless loop
        byte_read = Soft_UART_Read(error_) ' Read byte, then test error flag
        if (error_ <> 0) then ' If error was detected
            PORTB = error_ ' signal it on PORTB
        else
            Soft_UART_Write(byte_read) ' If error was not detected, return byte read
        end if
    wend
end.
```

SOUND LIBRARY

The mikroBasic PRO for AVR provides a Sound Library to supply users with routines necessary for sound signalization in their applications. Sound generation needs additional hardware, such as piezo-speaker (example of piezo-speaker interface is given on the schematic at the bottom of this page).

External dependencies of Sound Library

The following variables must be defined in all projects using Sound Library:	Description:	Example :
<code>dim Sound_Play_Pin as sbit sfr external</code>	Sound output pin.	<code>dim Sound_Play_Pin as sbit at PORTC.B3</code>
<code>dim Sound_Play_Pin_Direction as sbit sfr external</code>	Direction of the Sound output pin.	<code>dim Sound_Play_Pin_Direction as sbit at DDRC.B3</code>

Library Routines

- Sound_Init
- Sound_Play

Sound_Init

Prototype	<code>sub procedure Sound_Init()</code>
Returns	Nothing.
Description	Configures the appropriate MCU pin for sound generation.
Requires	Global variables: <ul style="list-style-type: none"> - <code>Sound_Play_Pin</code>: Sound output pin - <code>Sound_Play_Pin_Direction</code>: Direction of the Sound output pin must be defined before using this function.
Example	<pre>' Sound library connections dim Sound_Play_Pin as sbit at PORTC.B3 dim Sound_Play_Pin_Direction as sbit at DDRC.B3 ' End of Sound library connections ... Sound_Init()</pre>

Sound_Play

Prototype	<code>sub procedure Sound_Play(dim freq_in_Hz as word, dim duration_ms as word)</code>
Returns	Nothing.
Description	Generates the square wave signal on the appropriate pin. Parameters : <ul style="list-style-type: none"> - <code>freq_in_Hz</code>: signal frequency in Hertz (Hz) - <code>duration_ms</code>: signal duration in milliseconds (ms)
Requires	In order to hear the sound, you need a piezo speaker (or other hardware) on designated port. Also, you must call <code>Sound_Init</code> to prepare hardware for output before using this function.
Example	<pre>' Play sound of 1KHz in duration of 100ms Sound_Play(1000, 100)</pre>

Library Example

The example is a simple demonstration of how to use the Sound Library for playing tones on a piezo speaker.

```
program Sound

' Sound connections
dim Sound_Play_Pin as sbit at PORTC.B3
dim Sound_Play_Pin_direction as sbit at DDRC.B3
' End Sound connections

sub procedure Tone1
    Sound_Play(500, 200)      ' Frequency = 500Hz, Duration = 200ms
end sub

sub procedure Tone2
    Sound_Play(555, 200)      ' Frequency = 555Hz, Duration = 200ms
end sub

sub procedure Tone3
    Sound_Play(625, 200)      ' Frequency = 625Hz, Duration = 200ms
end sub

sub procedure Melody          ' Plays the melody "Yellow house"
    Tone1() Tone2() Tone3() Tone3()
    Tone1() Tone2() Tone3() Tone3()
    Tone1() Tone2() Tone3()
    Tone1() Tone2() Tone3() Tone3()
    Tone1() Tone2() Tone3()
    Tone3() Tone3() Tone2() Tone2() Tone1()
end sub

sub procedure ToneA          ' Tones used in Melody2 function
    Sound_Play(1250, 20)
end sub

sub procedure ToneC
    Sound_Play(1450, 20)
end sub

sub procedure ToneE
    Sound_Play(1650, 80)
end sub

sub procedure Melody2        ' Plays Melody2
dim counter as byte
    for counter = 9 to 1 step -1
```

```

        ToneA
        ToneC
        ToneE
    next counter
end sub

main:

    DDRB = 0x00                ' Configure PORTB as input
    Delay_ms(2000)
    Sound_Init()              ' Initialize sound pin

    Sound_Play(2000, 1000)    ' Play starting sound, 2kHz, 1 sec-
ond

    while TRUE                ' endless loop
        if (PINB.7 <> 0) then ' If PORTB.7 is pressed play Tone1
            Tone1()
            while (PINB.7 <> 0) ' Wait for button to be released
                nop
            wend
        end if

        if (PINB.6 <> 0) then ' If PORTB.6 is pressed play Tone2
            Tone2()
            while (PINB.6 <> 0) ' Wait for button to be released
                nop
            wend
        end if

        if (PINB.5 <> 0) then ' If PORTB.5 is pressed play Tone3
            Tone3()
            while (PINB.5 <> 0) ' Wait for button to be released
                nop
            wend
        end if

        if (PINB.4 <> 0) then ' If PORTB.4 is pressed play Melody2
            Melody2()
            while (PINB.4 <> 0) ' Wait for button to be released
                nop
            wend
        end if

        if (PINB.3 <> 0) then ' If PORTB.3 is pressed play Melody
            Melody()
            while (PINB.3)     ' Wait for button to be released
                nop
            wend
        end if
    wend
end.

```

HW Connection

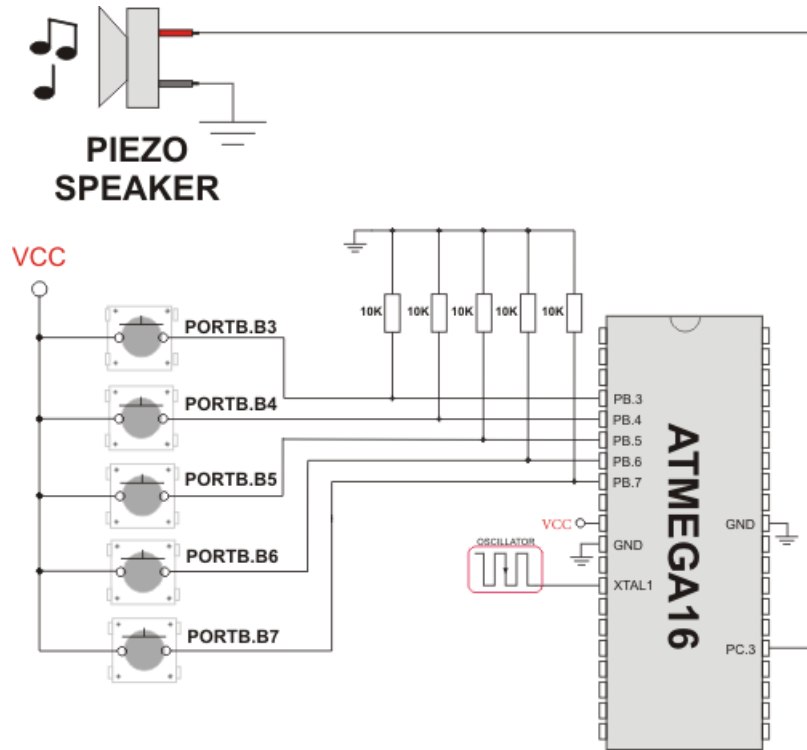

Example of Sound Library sonnection

SPI LIBRARY

mikroBasic PRO for AVR provides a library for comfortable with SPI work in Master mode. The AVR MCU can easily communicate with other devices via SPI: A/D converters, D/A converters, MAX7219, LTC1290, etc.

Note: Some AVR MCU's have alternative SPI ports, which SPI signals can be redirected to by setting or clearing SPIPS (SPI Pin Select) bit of the MCUCR register. Please consult the appropriate datasheet.

Library Routines

- SPI1_Init
- SPI1_Init_Advanced
- SPI1_Read
- SPI1_Write
- SPI1_Init

SPI1_Init

Prototype	<code>sub procedure SPI1_Init()</code>
Returns	Nothing.
Description	<p>This routine configures and enables SPI module with the following settings:</p> <ul style="list-style-type: none"> - master mode - 8 bit data transfer - most significant bit sent first - serial clock low when idle - data sampled on leading edge - serial clock = fosc/4
Requires	MCU must have SPI module.
Example	<pre>' Initialize the SPI module with default settings SPI1_Init()</pre>

SPI1_Init_Advanced

Prototype	<code>sub procedure SPI1_Init_Advanced(dim mode, fcy_div, clock_and_edge as byte)</code>		
Returns	Nothing.		
Description	Configures and initializes SPI. SPI1_Init_Advanced or SPI1_Init needs to be called before using other functions of SPI Library.		
	Parameters mode, fcy_div and clock_and_edge determine the work mode for SPI, and can have the following values:		
	Mask	Description	Predefined library const
	SPI mode constants:		
	0x10	Master mode	<code>_SPI_MASTER</code>
	0x00	Slave mode	<code>_SPI_SLAVE</code>
	Clock rate select constants:		
	0x00	<code>Sck = Fosc/4, Master mode</code>	<code>_SPI_FCY_DIV4</code>
	0x01	<code>Sck = Fosc/16, Master mode</code>	<code>_SPI_FCY_DIV16</code>
	0x02	<code>Sck = Fosc/64, Master mode</code>	<code>_SPI_FCY_DIV64</code>
	0x03	<code>Sck = Fosc/128, Master mode</code>	<code>_SPI_FCY_DIV128</code>
	0x04	<code>Sck = Fosc/2, Master mode</code>	<code>_SPI_FCY_DIV2</code>
	0x05	<code>Sck = Fosc/8, Master mode</code>	<code>_SPI_FCY_DIV8</code>
	0x06	<code>Sck = Fosc/32, Master mode</code>	<code>_SPI_FCY_DIV32</code>
	SPI clock polarity and phase constants:		
	0x00	Clock idle level is low, sample on rising edge	<code>_SPI_CLK_LO_LEADING</code>
	0x04	Clock idle level is low, sample on falling edge	<code>_SPI_CLK_LO_TRAILING</code>
	0x08	Clock idle level is high, sample on rising edge	<code>_SPI_CLK_HI_LEADING</code>
0x0C	Clock idle level is high, sample on falling edge	<code>_SPI_CLK_HI_TRAILING</code>	
Note: Some SPI clock speeds are not supported by all AVR MCUs and these are: <code>Fosc/2</code> , <code>Fosc/8</code> , <code>Fosc/32</code> . Please consult appropriate datasheet.			
Requires	MCU must have SPI module.		
Example	<pre>' Set SPI to the Master Mode, clock = Fosc/32 , clock idle level is high, data sampled on falling edge: SPI1_Init_Advanced(_SPI_MASTER, _SPI_FCY_DIV32, _SPI_CLK_HI_TRAILING);</pre>		

SPI1_Read

Prototype	<code>sub function SPI1_Read(dim buffer as byte) as byte</code>
Returns	Received data.
Description	<p>Reads one byte from the SPI bus.</p> <p>Parameters :</p> <p>- buffer: dummy data for clock generation (see device Datasheet for SPI modules implementation details)</p>
Requires	SPI module must be initialized before using this function. See SPI1_Init and SPI1_Init_Advanced routines.
Example	<pre>' read a byte from the SPI bus dim take, dummy1 as byte ... take = SPI1_Read(dummy1)</pre>

SPI1_Write

Prototype	<code>sub procedure SPI1_Write(dim wrdata as byte)</code>
Returns	Nothing.
Description	<p>Writes byte via the SPI bus.</p> <p>Parameters :</p> <p>- wrdata: data to be sent</p>
Requires	SPI module must be initialized before using this function. See SPI1_Init and SPI1_Init_Advanced routines.
Example	<pre>' write a byte to the SPI bus dim buffer as byte ... SPI1_Write(buffer)</pre>

Library Example

The code demonstrates how to use SPI library functions for communication between SPI module of the MCU and Microchip's MCP4921 12-bit D/A converter

```

program SPI

' DAC module connections
dim Chip_Select as sbit at PORTB.B0
    Chip_Select_Direction as sbit at DDRB.B0
' End DAC module connections

dim value as word

sub procedure InitMain()
    DDA0_bit = 0           ' Set PA0 pin as input
    DDA1_bit = 0           ' Set PA1 pin as input
    Chip_Select = 1       ' Deselect DAC
    Chip_Select_Direction = 1 ' Set CS# pin as Output
    SPI1_Init()           ' Initialize SPI1 module
end sub

' DAC increments (0..4095) --> output voltage (0..Vref)
sub procedure DAC_Output(dim valueDAC as word)
dim temp as byte
    Chip_Select = 0           ' Select DAC chip
    ' Send High Byte
    temp = word(valueDAC >> 8) and 0x0F ' Store valueDAC[11..8] to
temp[3..0]
    temp = temp or 0x30 ' Define DAC setting, see MCP4921 datasheet
    SPI1_Write(temp)        ' Send high byte via SPI

    ' Send Low Byte
    temp = valueDAC         ' Store valueDAC[7..0] to temp[7..0]
    SPI1_Write(temp)       ' Send low byte via SPI

    Chip_Select = 1           ' Deselect DAC chip
end sub

main:
    InitMain()               ' Perform main initialization
    value = 2048             ' When program starts, DAC gives
                             ' the output in the mid-range
    while TRUE               ' Endless loop

        if ((PINA0_bit) and (value < 4095)) then ' If PA0 button is
pressed
            Inc(value)       ' increment value
        else

```

SPI ETHERNET LIBRARY

The [ENC28J60](#) is a stand-alone Ethernet controller with an industry standard Serial Peripheral Interface (SPI™). It is designed to serve as an Ethernet network interface for any controller equipped with SPI.

The [ENC28J60](#) meets all of the IEEE 802.3 specifications. It incorporates a number of packet filtering schemes to limit incoming packets. It also provides an internal DMA module for fast data throughput and hardware assisted IP checksum calculations. Communication with the host controller is implemented via two interrupt pins and the SPI, with data rates of up to 10 Mb/s. Two dedicated pins are used for LED link and network activity indication.

This library is designed to simplify handling of the underlying hardware ([ENC28J60](#)). It works with any AVR MCU with integrated SPI and more than 4 Kb ROM memory.

SPI Ethernet library supports:

- IPv4 protocol.
- ARP requests.
- ICMP echo requests.
- UDP requests.
- TCP requests (no stack, no packet reconstruction).
- packet fragmentation is **NOT** supported.

Note: Prior to calling any of this library routines, Spi_Rd_Ptr needs to be initialized with the appropriate SPI_Read routine.

Note: The appropriate hardware SPI module must be initialized before using any of the SPI Ethernet library routines. Refer to SPI Library.

External dependencies of SPI Ethernet Library

The following variables must be defined in all projects using SPI Ethernet Library:	Description:	Example :
<code>dim SPI_Ethernet_CS as sbit sfr external</code>	ENC28J60 chip select pin.	<code>dim SPI_Ethernet_CS as sbit at PORTB.B4</code>
<code>dim SPI_Ethernet_RST as sbit sfr external</code>	ENC28J60 reset pin.	<code>dim SPI_Ethernet_RST as sbit at PORTB.B5</code>
<code>dim SPI_Ethernet_CS_Direction as sbit sfr external</code>	Direction of the ENC28J60 chip select pin.	<code>dim SPI_Ethernet_CS_Direction as sbit at DDRB.B4</code>
<code>dim SPI_Ethernet_RST_Direction as sbit sfr external</code>	Direction of the ENC28J60 reset pin.	<code>dim SPI_Ethernet_RST_Direction as sbit at DDRB.B5</code>

The following routines must be defined in all project using SPI Ethernet Library:	Description:	Example :
<pre>sub function Spi_Ethernet_UserTCP(dim remoteHost as ^byte, dim remotePort as word, dim localPort as word, dim reqLength as word) as word</pre>	TCP request handler.	Refer to the library example at the bottom of this page for code implementation.
<pre>sub function Spi_Ethernet_UserUDP(dim remoteHost as ^byte, dim remotePort as word, dim destPort as word, dim reqLength as word) as word</pre>	UDP request handler.	Refer to the library example at the bottom of this page for code implementation.

Library Routines

- Spi_Ethernet_Init
- Spi_Ethernet_Enable
- Spi_Ethernet_Disable
- Spi_Ethernet_doPacket
- Spi_Ethernet_putByte
- Spi_Ethernet_putBytes
- Spi_Ethernet_putString
- Spi_Ethernet_putConstString
- Spi_Ethernet_putConstBytes
- Spi_Ethernet_getByte
- Spi_Ethernet_getBytes
- Spi_Ethernet_UserTCP
- Spi_Ethernet_UserUDP

Spi_Ethernet_Init

Prototype	<code>sub procedure Spi_Ethernet_Init(dim mac as ^byte, dim ip as ^byte, dim fullDuplex as byte)</code>
Returns	Nothing.
Description	<p>This is MAC module routine. It initializes ENC28J60 controller. This function is internally splitted into 2 parts to help linker when coming short of memory.</p> <p>ENC28J60 controller settings (parameters not mentioned here are set to default):</p> <ul style="list-style-type: none"> - receive buffer start address : 0x0000. - receive buffer end address : 0x19AD. - transmit buffer start address: 0x19AE. - transmit buffer end address : 0x1FFF. - RAM buffer read/write pointers in auto-increment mode. - receive filters set to default: CRC + MAC Unicast + MAC Broadcast in OR mode. - flow control with TX and RX pause frames in full duplex mode. - frames are padded to 60 bytes + CRC. - maximum packet size is set to 1518. - Back-to-Back Inter-Packet Gap: 0x15 in full duplex mode; 0x12 in half duplex mode. - Non-Back-to-Back Inter-Packet Gap: 0x0012 in full duplex mode; 0x0C12 in half duplex mode. - Collision window is set to 63 in half duplex mode to accomodate some ENC28J60 revisions silicon bugs. - CLKOUT output is disabled to reduce EMI generation. - half duplex loopback disabled. - LED configuration: default (LEDA-link status, LEDB-link activity).

Description	Parameters: <ul style="list-style-type: none">- <code>mac</code>: RAM buffer containing valid MAC address.- <code>ip</code>: RAM buffer containing valid IP address.- <code>fullDuplex</code>: ethernet duplex mode switch. Valid values: 0 (half duplex mode) and 1 (full duplex mode).
Requires	The appropriate hardware SPI module must be previously initialized.
Example	<pre>const Spi_Ethernet_HALFDUPLEX = 0 const Spi_Ethernet_FULLDUPLEX = 1 myMacAddr as byte[6] ' my MAC address myIpAddr as byte[4] ' my IP addr ... myMacAddr[0] = 0x00 myMacAddr[1] = 0x14 myMacAddr[2] = 0xA5 myMacAddr[3] = 0x76 myMacAddr[4] = 0x19 myMacAddr[5] = 0x3F myIpAddr[0] = 192 myIpAddr[1] = 168 myIpAddr[2] = 20 myIpAddr[3] = 60 Spi_Init() Spi_Ethernet_Init(PORTC, 0, PORTC, 1, myMacAddr, myIpAddr, Spi_Ethernet_FULLDUPLEX)</pre>

Spi_Ethernet_Enable

Prototype	<code>sub procedure Spi_Ethernet_Enable(dim enFlt as byte)</code>		
Returns	Nothing.		
Description	<p>This is MAC module routine. This routine enables appropriate network traffic on the ENC28J60 module by the means of it's receive filters (unicast, multicast, broadcast, crc). Specific type of network traffic will be enabled if a corresponding bit of this routine's input parameter is set. Therefore, more than one type of network traffic can be enabled at the same time. For this purpose, predefined library constants (see the table below) can be ORed to form appropriate input value.</p> <p>Parameters:</p> <ul style="list-style-type: none"> - <code>enFlt</code>: network traffic/receive filter flags. Each bit corresponds to the appropriate network traffic/receive filter: 		
	Bit	Mask	Description
	0	0x01	MAC Broadcast traffic/receive filter flag. When set, MAC broadcast traffic will be enabled.
	1	0x02	MAC Multicast traffic/receive filter flag. When set, MAC multicast traffic will be enabled.
	2	0x04	not used
	3	0x08	not used
	4	0x10	not used
	5	0x20	CRC check flag. When set, packets with invalid CRC field will be discarded.
	6	0x40	not used
	7	0x80	MAC Unicast traffic/receive filter flag. When set, MAC unicast traffic will be enabled.
		Predefined library const	
		<code>Spi_Ethernet_BROADCAST</code>	
		<code>Spi_Ethernet_MULTICAST</code>	
		<code>none</code>	
		<code>none</code>	
		<code>none</code>	
		<code>Spi_Ethernet_CRC</code>	
		<code>none</code>	
		<code>Spi_Ethernet_UNICAST</code>	

Description	<p>Note: Advance filtering available in the <code>ENC28J60</code> module such as <code>Pattern Match</code>, <code>Magic Packet</code> and <code>Hash Table</code> can not be enabled by this routine. Additionally, all filters, except CRC, enabled with this routine will work in OR mode, which means that packet will be received if any of the enabled filters accepts it.</p> <p>Note: This routine will change receive filter configuration on-the-fly. It will not, in any way, mess with enabling/disabling receive/transmit logic or any other part of the <code>ENC28J60</code> module. The <code>ENC28J60</code> module should be properly configured by the means of <code>Spi_Ethernet_Init</code> routine.</p>
Requires	Ethernet module has to be initialized. See <code>Spi_Ethernet_Init</code> .
Example	<pre>Spi_Ethernet_Enable(Spi_Ethernet_CRC or Spi_Ethernet_UNICAST) ' enable CRC checking and Unicast traffic</pre>

Spi_Ethernet_Disable

Prototype	<code>sub procedure Spi_Ethernet_Disable(dim disFlt as byte)</code>
Returns	Nothing.
Description	<p>This is MAC module routine. This routine disables appropriate network traffic on the <code>ENC28J60</code> module by the means of its receive filters (unicast, multicast, broadcast, crc). Specific type of network traffic will be disabled if a corresponding bit of this routine's input parameter is set. Therefore, more than one type of network traffic can be disabled at the same time. For this purpose, predefined library constants (see the table below) can be ORed to form appropriate input value.</p> <p>Parameters:</p> <ul style="list-style-type: none"> - <code>disFlt</code>: network traffic/receive filter flags. Each bit corresponds to the appropriate network traffic/receive filter:

Description	Bit	Mask	Description	Predefined library const
	0	0x01	MAC Broadcast traffic/receive filter flag. When set, MAC broadcast traffic will be disabled.	<code>Spi_Ethernet_BROADCAST</code>
	1	0x02	MAC Multicast traffic/receive filter flag. When set, MAC multicast traffic will be disabled.	<code>Spi_Ethernet_MULTICAST</code>
	2	0x04	not used	none
	3	0x08	not used	none
	4	0x10	not used	none
	5	0x20	CRC check flag. When set, CRC check will be disabled and packets with invalid CRC field will be accepted.	<code>Spi_Ethernet_CRC</code>
	6	0x40	not used	none
	7	0x80	MAC Unicast traffic/receive filter flag. When set, MAC unicast traffic will be disabled.	<code>Spi_Ethernet_UNICAST</code>
<p>Note: Advance filtering available in the <code>ENC28J60</code> module such as <code>Pattern Match</code>, <code>Magic Packet</code> and <code>Hash Table</code> can not be disabled by this routine.</p> <p>Note: This routine will change receive filter configuration on-the-fly. It will not, in any way, mess with enabling/disabling receive/transmit logic or any other part of the <code>ENC28J60</code> module. The <code>ENC28J60</code> module should be properly configured by the means of <code>Spi_Ethernet_Init</code> routine.</p>				
Requires	Ethernet module has to be initialized. See <code>Spi_Ethernet_Init</code> .			
Example	<pre>Spi_Ethernet_Disable(Spi_Ethernet_CRC or Spi_Ethernet_UNICAST) ' disable CRC checking and Unicast traffic</pre>			

Spi_Ethernet_doPacket

Prototype	<code>sub function Spi_Ethernet_doPacket() as byte</code>
Returns	<ul style="list-style-type: none"> - 0 - upon successful packet processing (zero packets received or received packet processed successfully). - 1 - upon reception error or receive buffer corruption. ENC28J60 controller needs to be restarted. - 2 - received packet was not sent to us (not our IP, nor IP broadcast address). - 3 - received IP packet was not IPv4. - 4 - received packet was of type unknown to the library.
Description	<p>This is MAC module routine. It processes next received packet if such exists. Packets are processed in the following manner:</p> <ul style="list-style-type: none"> - ARP & ICMP requests are replied automatically. - upon TCP request the Spi_Ethernet_UserTCP function is called for further processing. - upon UDP request the Spi_Ethernet_UserUDP function is called for further processing. <p>Note: Spi_Ethernet_doPacket must be called as often as possible in user's code.</p>
Requires	Ethernet module has to be initialized. See Spi_Ethernet_Init.
Example	<pre>while TRUE ... Spi_Ethernet_doPacket() ' process received packets ... wend</pre>

Spi_Ethernet_putByte

Prototype	<code>sub procedure Spi_Ethernet_putByte(dim v as byte)</code>
Returns	Nothing.
Description	<p>This is MAC module routine. It stores one byte to address pointed by the current ENC28J60 write pointer (EWRPT).</p> <p>Parameters:</p> <ul style="list-style-type: none"> - <code>v</code>: value to store
Requires	Ethernet module has to be initialized. See Spi_Ethernet_Init.
Example	<pre>dim data as byte ... Spi_Ethernet_putByte(data) ' put an byte into ENC28J60 buffer</pre>

Spi_Ethernet_putBytes

Prototype	<code>sub procedure Spi_Ethernet_putBytes(dim ptr as ^byte, dim n as byte)</code>
Returns	Nothing.
Description	<p>This is MAC module routine. It stores requested number of bytes into ENC28J60 RAM starting from current ENC28J60 write pointer (EWRPT) location.</p> <p>Parameters:</p> <ul style="list-style-type: none"> - <code>ptr</code>: RAM buffer containing bytes to be written into ENC28J60 RAM. - <code>n</code>: number of bytes to be written.
Requires	Ethernet module has to be initialized. See Spi_Ethernet_Init.
Example	<pre>dim buffer as byte[17] ... buffer = "mikroElektronika" ... Spi_Ethernet_putBytes(buffer, 16) ' put an RAM array into ENC28J60 buffer</pre>

Spi_Ethernet_putConstBytes

Prototype	<code>sub procedure Spi_Ethernet_putConstBytes(const ptr as ^byte, dim n as byte)</code>
Returns	Nothing.
Description	<p>This is MAC module routine. It stores requested number of const bytes into ENC28J60 RAM starting from current ENC28J60 write pointer (EWRPT) location.</p> <p>Parameters:</p> <ul style="list-style-type: none"> - <code>ptr</code>: const buffer containing bytes to be written into ENC28J60 RAM. - <code>n</code>: number of bytes to be written.
Requires	Ethernet module has to be initialized. See Spi_Ethernet_Init.
Example	<pre>const buffer as byte[17] ... buffer = "mikroElektronika" ... Spi_Ethernet_putConstBytes(buffer, 16) ' put a const array into ENC28J60 buffer</pre>

Spi_Ethernet_putString

Prototype	<code>sub function Spi_Ethernet_putString(dim ptr as ^byte) as word</code>
Returns	Number of bytes written into ENC28J60 RAM.
Description	<p>This is MAC module routine. It stores whole string (excluding null termination) into ENC28J60 RAM starting from current ENC28J60 write pointer (EWRPT) location.</p> <p>Parameters:</p> <ul style="list-style-type: none"> - <code>ptr</code>: string to be written into ENC28J60 RAM.
Requires	Ethernet module has to be initialized. See Spi_Ethernet_Init.
Example	<pre>dim buffer as string[16] ... buffer = "mikroElektronika" ... Spi_Ethernet_putString(buffer) ' put a RAM string into ENC28J60 buffer</pre>

Spi_Ethernet_putConstString

Prototype	<code>sub function Spi_Ethernet_putConstString(const ptr as ^byte) as word</code>
Returns	Number of bytes written into ENC28J60 RAM.
Description	<p>This is MAC module routine. It stores whole const string (excluding null termination) into ENC28J60 RAM starting from current ENC28J60 write pointer (EWRPT) location.</p> <p>Parameters:</p> <p>- <code>ptr</code>: const string to be written into ENC28J60 RAM.</p>
Requires	Ethernet module has to be initialized. See Spi_Ethernet_Init.
Example	<pre>const buffer as string[16] ... buffer = "mikroElektronika" ... Spi_Ethernet_putConstString(buffer) ' put a const string into ENC28J60 buffer</pre>

Spi_Ethernet_getByte

Prototype	<code>sub function Spi_Ethernet_getByte() as byte</code>
Returns	Byte read from ENC28J60 RAM.
Description	This is MAC module routine. It fetches a byte from address pointed to by current ENC28J60 read pointer (ERDPT).
Requires	Ethernet module has to be initialized. See Spi_Ethernet_Init.
Example	<pre>dim buffer as byte<> ... buffer = Spi_Ethernet_getByte() ' read a byte from ENC28J60 buffer</pre>

Spi_Ethernet_getBytes

Prototype	<code>sub procedure Spi_Ethernet_getBytes(dim ptr as ^byte, dim addr as word, dim n as byte)</code>
Returns	Nothing.
Description	<p>This is MAC module routine. It fetches requested number of bytes from ENC28J60 RAM starting from given address. If value of 0xFFFF is passed as the address parameter, the reading will start from current ENC28J60 read pointer (ERDPT) location.</p> <p>Parameters:</p> <ul style="list-style-type: none"> - <code>ptr</code>: buffer for storing bytes read from ENC28J60 RAM. - <code>addr</code>: ENC28J60 RAM start address. Valid values: 0..8192. - <code>n</code>: number of bytes to be read.
Requires	Ethernet module has to be initialized. See Spi_Ethernet_Init.
Example	<pre>dim buffer as byte[16] ... Spi_Ethernet_getBytes(buffer, 0x100, 16) ' read 16 bytes, starting from address 0x100</pre>

Spi_Ethernet_UserTCP

Prototype	<code>sub function Spi_Ethernet_UserTCP(dim remoteHost as ^byte, dim remotePort as word, dim localPort as word, dim reqLength as word) as word</code>
Returns	<ul style="list-style-type: none"> - 0 - there should not be a reply to the request. - Length of TCP/HTTP reply data field - otherwise.
Description	<p>This is TCP module routine. It is internally called by the library. The user accesses to the TCP/HTTP request by using some of the Spi_Ethernet_get routines. The user puts data in the transmit buffer by using some of the Spi_Ethernet_put routines. The function must return the length in bytes of the TCP/HTTP reply, or 0 if there is nothing to transmit. If there is no need to reply to the TCP/HTTP requests, just define this function with return(0) as a single statement.</p> <p>Parameters:</p> <ul style="list-style-type: none"> - <code>remoteHost</code>: client's IP address. - <code>remotePort</code>: client's TCP port. - <code>localPort</code>: port to which the request is sent. - <code>reqLength</code>: TCP/HTTP request data field length. <p>Note: The function source code is provided with appropriate example projects. The code should be adjusted by the user to achieve desired reply.</p>
Requires	Ethernet module has to be initialized. See Spi_Ethernet_Init.
Example	This function is internally called by the library and should not be called by the user's code.

Spi_Ethernet_UserUDP

Prototype	<pre>sub function Spi_Ethernet_UserUDP(dim remoteHost as ^byte, dim remotePort as word, dim destPort as word, dim reqLength as word) as word</pre>
Returns	<ul style="list-style-type: none">- 0 - there should not be a reply to the request.- Length of UDP reply data field - otherwise.
Description	<p>This is UDP module routine. It is internally called by the library. The user accesses to the UDP request by using some of the Spi_Ethernet_get routines. The user puts data in the transmit buffer by using some of the Spi_Ethernet_put routines. The function must return the length in bytes of the UDP reply, or 0 if nothing to transmit. If you don't need to reply to the UDP requests, just define this function with a return(0) as single statement.</p> <p>Parameters:</p> <ul style="list-style-type: none">- <code>remoteHost</code>: client's IP address.- <code>remotePort</code>: client's port.- <code>destPort</code>: port to which the request is sent.- <code>reqLength</code>: UDP request data field length. <p>Note: The function source code is provided with appropriate example projects. The code should be adjusted by the user to achieve desired reply.</p>
Requires	Ethernet module has to be initialized. See Spi_Ethernet_Init.
Example	This function is internally called by the library and should not be called by the user's code.

Library Example

This code shows how to use the AVR mini Ethernet library :

- the board will reply to ARP & ICMP echo requests
- the board will reply to UDP requests on any port :
 - returns the request in upper char with a header made of remote host IP & port number
- the board will reply to HTTP requests on port 80, GET method with pathnames :

- / will return the HTML main page
- /s will return board status as text string
- /t0 ... /t7 will toggle P3.b0 to P3.b7 bit and return HTML main page
- all other requests return also HTML main page.

Main program code:

```
include eth_enc28j60_utils 'this is where you should write implemen-
tation for UDP and HTTP
*****
'* RAM variables
'*
*****
dim myMacAddr   as byte[ 6]   ' my MAC address
    myIpAddr    as byte[ 4]   ' my IP address
    gwIpAddr    as byte[ 4]   ' gateway (router) IP address
    ipMask      as byte[ 4]   ' network mask (for example :
255.255.255.0)
    dnsIpAddr   as byte[ 4]   ' DNS server IP address

' mE ethernet NIC pinout
    SPI_Ethernet_Rst as sbit at PORTB.B4
    SPI_Ethernet_CS  as sbit at PORTB.B5
    SPI_Ethernet_Rst_Direction as sbit at DDRB.B4
    SPI_Ethernet_CS_Direction  as sbit at DDRB.B5
' end ethernet NIC definitions

dim i as word

main:
' set PORTC as input
DDRC = 0
' set PORTD as output
DDRD = 0xFF

httpCounter = 0
```

```
myMacAddr[ 0] = 0x00
myMacAddr[ 1] = 0x14
myMacAddr[ 2] = 0xA5
myMacAddr[ 3] = 0x76
myMacAddr[ 4] = 0x19
myMacAddr[ 5] = 0x3F

myIpAddr[ 0] = 192
myIpAddr[ 1] = 168
myIpAddr[ 2] = 20
myIpAddr[ 3] = 60

gwIpAddr[ 0] = 192
gwIpAddr[ 1] = 168
gwIpAddr[ 2] = 20
gwIpAddr[ 3] = 6

ipMask[ 0] = 255
ipMask[ 1] = 255
ipMask[ 2] = 255
ipMask[ 3] = 0

dnsIpAddr[ 0] = 192
dnsIpAddr[ 1] = 168
dnsIpAddr[ 2] = 20
dnsIpAddr[ 3] = 1

' *
' * starts ENC28J60 with :
' * reset bit on PORTB.B4
' * CS bit on PORTB.B5
' * my MAC & IP address
' * full duplex
' *

SPI1_Init_Advanced(_SPI_MASTER, _SPI_FCY_DIV2, _SPI_CLK_LO_LEAD-
ING)
SPI_Rd_Ptr = @SPI1_Read
SPI_Ethernet_UserTCP_Ptr = @SPI_Ethernet_UserTCP
SPI_Ethernet_UserUDP_Ptr = @SPI_Ethernet_UserUDP
SPI_Ethernet_Init(myMacAddr, myIpAddr, SPI_Ethernet_FULLDUPLEX)

' dhcp will not be used here, so use preconfigured addresses
SPI_Ethernet_confNetwork(ipMask, gwIpAddr, dnsIpAddr)

while TRUE ' do forever
    SPI_Ethernet_doPacket() ' process incoming Ethernet packets
    '*
    '* add your stuff here if needed
    '* SPI_Ethernet_doPacket() must be called as often as possible
    '* otherwise packets could be lost
    '*
wend
end.
```

Module eth_enc28j60_utils code:

```

module eth_enc28j60_utils

*****
'* ROM constant strings
*****

const httpHeader as string[ 30] = "HTTP/1.1 200 OK"+chr(10)+"Content-
type: "      ' HTTP header
const httpMimeTypeHTML as string[ 13]      = "text/html"+chr(10)+chr(10)
' HTML MIME type
const      httpMimeTypeScript      as      string[ 14]      =
"text/plain"+chr(10)+chr(10)      ' TEXT MIME type
const httpMethod as string[ 5] = "GET /"
'*
'* web page, splited into 2 parts :
'* when coming short of ROM, fragmented data is handled more effi-
ciently by linker
'*
'* this HTML page calls the boards to get its status, and builds
itself with javascript
'*

const indexPage as string[ 513] =
      "<meta http-equiv=" + Chr(34) + "refresh" +
Chr(34) + " content=" + Chr(34) + "3;url=http://192.168.20.60" +
Chr(34) + ">" +
      "<HTML><HEAD></HEAD><BODY>"+
      "<h1>AVR + ENC28J60 Mini Web Server</h1>"+
      "<a href=/>Reload</a>"+
      "<script src=/s></script>"+
      "      <table><tr><td valign=top><table border=1
style="+chr(34)+"font-size:20px      ;font-family:      terminal
;"+chr(34)+">"+
      "      <tr><th colspan=2>PINC</th></tr>"+
      "<script>"+
      "var str,i;"+
      "str="+chr(34)+chr(34)+";"+
      "for (i=0;i<8;i++)"+
      "  { str="+chr(34)+"<tr><td bgcolor=pink>BUTTON
#"+chr(34)+"i"+chr(34)+"</td>"+chr(34)+";"+
      "    if (PINC&(1<<i)) { str="+chr(34)+"<td
bgcolor=red>ON"+chr(34)+"; } "+
      "      else { str="+chr(34)+"<td
bgcolor=#cccccc>OFF"+chr(34)+"; } "+
      "str="+chr(34)+"</td></tr>"+chr(34)+"; } "+
      "document.write(str) ;"+
      "</script>"

```

```
const indexPage2 as string[ 466] =
    "</table></td><td>"+
    "<table border=1 style="+chr(34)+"font-size:20px
;font-family: terminal ;"+chr(34)+">"+
    "<tr><th colspan=3>PORTD</th></tr>"+
    "<script>"+
    "var str,i;"+
    "str="+chr(34)+chr(34)+";"+
    "for (i=0;i<8;i++)"+
    "    { str="+chr(34)+"<tr><td bgcolor=yellow>LED
#"+chr(34)+"i"+chr(34)+"</td>"+chr(34)+";"+
    "    if (PORTD&(1<<i)) { str="+chr(34)+"<td
bgcolor=red>ON"+chr(34)+"; } "+
    "    else { str="+chr(34)+"<td
bgcolor=#cccccc>OFF"+chr(34)+"; } "+
    "    str="+chr(34)+"</td><td><a
href=/t"+chr(34)+"i"+chr(34)+">Toggle</a></td></tr>"+chr(34)+"; } "+
    "</script>"+
    "</table></td></tr></table>"+
    "This is HTTP request
#<script>document.write(REQ)</script></BODY></HTML>"

dim    getRequest as byte[ 15]  ' HTTP request buffer
       dyna       as byte[ 31]  ' buffer for dynamic response
       httpCounter as word      ' counter of HTTP requests

sub function SPI_Ethernet_UserTCP(dim byref remoteHost as byte[ 4] ,
dim remotePort, localPort, reqLength as word) as word
sub function SPI_Ethernet_UserUDP(dim byref remoteHost as byte[ 4] ,
dim remotePort, destPort, reqLength as word) as word

implements
*****
'* user defined sub functions
'*

'*
'* put the constant string pointed to by s to the ENC transmit buffer
'*

sub function putConstString (dim const s as ^byte) as word
    result = 0
    while (s^ <> 0)
        SPI_Ethernet_putByte(s^)
        Inc(s)
        Inc(result)
    wend
end sub
```

```

'*
'* put the string pointed to by s to the ENC transmit buffer
'*
sub function putString(dim byref s as byte[ 100] ) as word
    result = 0
    while(s[ result] <> 0)
        SPI_Ethernet_putByte(s[ result])
        Inc(result)
    wend
end sub
'*
'* this sub function is called by the library
'* the user accesses to the HTTP request by successive calls to
SPI_Ethernet_getByte()
'* the user puts data in the transmit buffer by successive calls to
SPI_Ethernet_putByte()
'* the sub function must return the length in bytes of the HTTP reply,
or 0 if nothing to transmit
'*
'* if you don"t need to reply to HTTP requests,
'* just define this sub function with a return(0) as single state-
ment
'*
'*
sub function Spi_Ethernet_UserTCP(dim byref remoteHost as byte[ 4] ,
                                dim remotePort, localPort, reqLength
as word) as word
    dim len_ as word           ' my reply length
        bitMask as byte       ' for bit mask
        tmp as byte[ 5]       ' to copy const array to ram for memcmp

    len_ = 0
    if(localPort <> 80) then ' I listen only to web request on port 80
        result = 0
        exit
    end if

    ' get 10 first bytes only of the request, the rest does not mat-
    ter here
    for len_ = 0 to 9
        getRequest[ len_] = SPI_Ethernet_getByte()
    next len_
    getRequest[ len_] = 0
    len_ = 0

    while (httpMethod[ len_] <> 0)
        tmp[ len_] = httpMethod[ len_]
        Inc(len_)
    wend
    len_ = 0

```

```
if(memcmp (@getRequest, @tmp, 5) <> 0) then ' only GET method is
supported here
    result = 0
    exit
end if

httpCounter = httpCounter + 1 ' one more request done

if(getRequest[ 5] = "s") then ' if request path
name starts with s, store dynamic data in transmit buffer
' the text string replied by this request can be interpreted
as javascript statements
' by browsers
len_ = putConstString(@httpHeader) ' HTTP header
len_ = len_ + putConstString(@httpMimeTypeScript) ' with text
MIME type

' add PORTC value (buttons) to reply
len_ = len_ + putString("var PINC= ")
WordToStr(PINC, dyna)
len_ = len_ + putString(dyna)
len_ = len_ + putString(";")

' add PORTD value (LEDs) to reply
len_ = len_ + putString("var PORTD= ")
WordToStr(PORTD, dyna)
len_ = len_ + putString(dyna)
len_ = len_ + putString(";")

' add HTTP requests counter to reply
WordToStr(httpCounter, dyna)
len_ = len_ + putString("var REQ= ")
len_ = len_ + putString(dyna)
len_ = len_ + putString(";")
else
if(getRequest[ 5] = "t") then ' if request path
name starts with t, toggle PORTD (LED) bit number that comes after
bitMask = 0
if(isdigit(getRequest[ 6]) <> 0) then ' if 0 <=
bit number <= 9, bits 8 & 9 does not exist but does not matter
bitMask = getRequest[ 6] - "0" ' convert ASCII
to integer
bitMask = 1 << bitMask ' create bit mask
PORTD = PORTD xor bitMask ' toggle PORTD
with xor operator
end if
end if
end if
```

```

    if(len_ = 0) then
        len_ = putConstString(@httpHeader)
        len_ = len_ + putConstString(@httpMimeTypeHTML)
MIME type
        len_ = len_ + putConstString(@indexPage)
        len_ = len_ + putConstString(@indexPage2)
second part
    end if
    result = len_
number of bytes to transmit
end sub
' *
' * this sub function is called by the library
' * the user accesses to the UDP request by successive calls to
SPI_Ethernet_getByte()
' * the user puts data in the transmit buffer by successive calls to
SPI_Ethernet_putByte()
' * the sub function must return the length in bytes of the UDP reply,
or 0 if nothing to transmit
' *
' * if you don't need to reply to UDP requests,
' * just define this sub function with a return(0) as single state-
ment
' *
' *
sub function Spi_Ethernet_UserUDP(dim byref remoteHost as byte[ 4] ,
                                dim remotePort, destPort, reqLength
as word) as word
    dim len_ as word
    ptr as ^byte
    tmp as string[ 5]

    ' reply is made of the remote host IP address in human readable
format
    byteToStr(remoteHost[ 0] , dyna)
    dyna[ 3] = "."

    byteToStr(remoteHost[ 1] , tmp)
    dyna[ 4] = tmp[ 0]
    dyna[ 5] = tmp[ 1]
    dyna[ 6] = tmp[ 2]
    dyna[ 7] = "."

    byteToStr(remoteHost[ 2] , tmp)
    dyna[ 8] = tmp[ 0]
    dyna[ 9] = tmp[ 1]
    dyna[ 10] = tmp[ 2]
    dyna[ 11] = "."

```

```
byteToStr(remoteHost[ 3], tmp)      ' second
dyna[ 12] = tmp[ 0]
dyna[ 13] = tmp[ 1]
dyna[ 14] = tmp[ 2]

dyna[ 15] = ":"                      ' add separator

' then remote host port number
WordToStr(remotePort, tmp)
dyna[ 16] = tmp[ 0]
dyna[ 17] = tmp[ 1]
dyna[ 18] = tmp[ 2]
dyna[ 19] = tmp[ 3]
dyna[ 20] = tmp[ 4]
dyna[ 21] = " "
dyna[ 22] = "[ "

WordToStr(destPort, tmp)
dyna[ 23] = tmp[ 0]
dyna[ 24] = tmp[ 1]
dyna[ 25] = tmp[ 2]
dyna[ 26] = tmp[ 3]
dyna[ 27] = tmp[ 4]
dyna[ 28] = "]"
dyna[ 29] = " "
dyna[ 30] = 0

' the total length of the request is the length of the dynamic
string plus the text of the request
len_ = 30 + reqLength

' puts the dynamic string into the transmit buffer
ptr = @dyna
while (ptr^ <> 0)
    SPI_Ethernet_putByte(ptr^)
    ptr = ptr + 1
wend

' then puts the request string converted into upper char into
the transmit buffer
while(reqLength <> 0)
    SPI_Ethernet_putByte(SPI_Ethernet_getByte())
    reqLength = reqLength - 1
wend

    result = len_                      ' back to the library with the length
of the UDP reply
end sub

end.
```

HW Connection

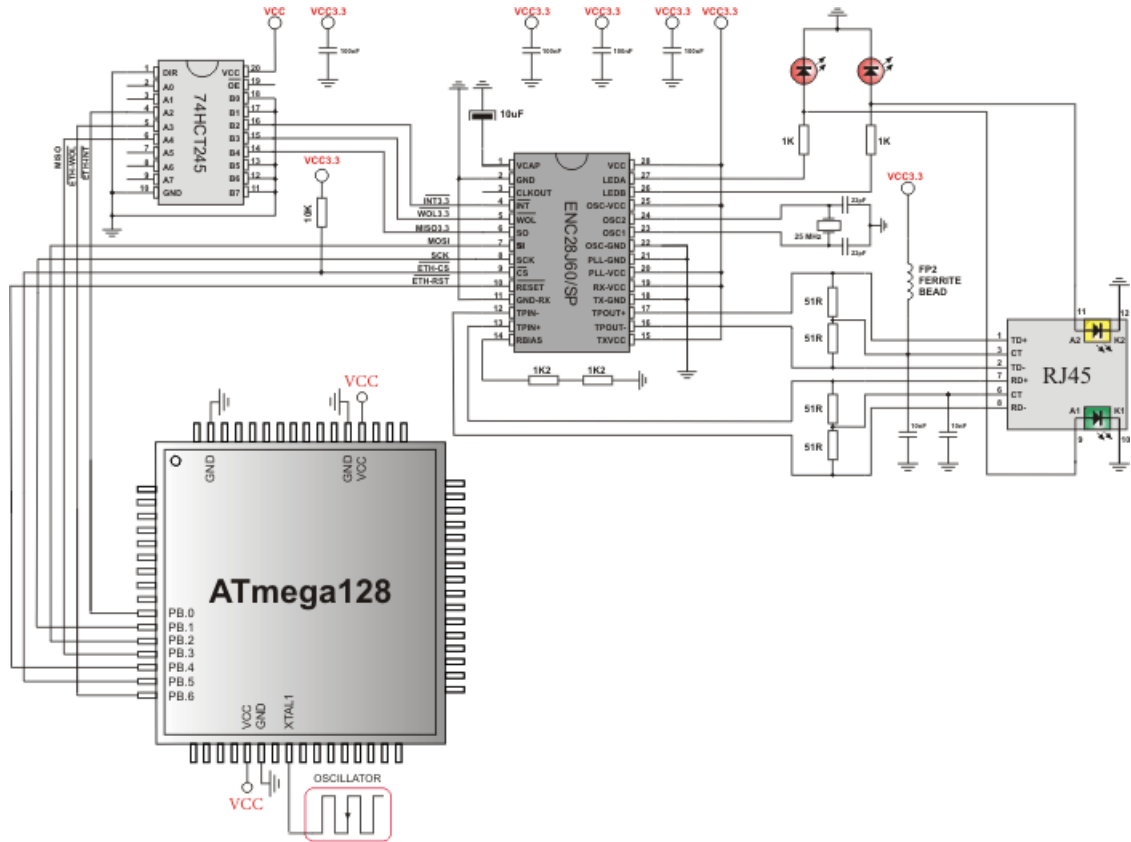

SPI GRAPHIC LCD LIBRARY

The mikroBasic PRO for AVR provides a library for operating Graphic Lcd 128x64 (with commonly used Samsung KS108/KS107 controller) via SPI interface.

For creating a custom set of Glcd images use Glcd Bitmap Editor Tool.

Note: The library uses the SPI module for communication. User must initialize SPI module before using the SPI Graphic Lcd Library.

Note: This Library is designed to work with the mikroElektronika's Serial Lcd/Glcd Adapter Board pinout, see schematic at the bottom of this page for details.

External dependencies of SPI Graphic Lcd Library

The implementation of SPI Graphic Lcd Library routines is based on Port Expander Library routines.

Prior to calling any of this library routines, Spi_Rd_Ptr needs to be initialized with the appropriate SPI_Read routine.

External dependencies are the same as Port Expander Library external dependencies.

Library Routines

Basic routines:

- SPI_Glcd_Init
- SPI_Glcd_Set_Side
- SPI_Glcd_Set_Page
- SPI_Glcd_Set_X
- SPI_Glcd_Read_Data
- SPI_Glcd_Write_Data

Advanced routines:

- SPI_Glcd_Fill
- SPI_Glcd_Dot
- SPI_Glcd_Line
- SPI_Glcd_V_Line
- SPI_Glcd_H_Line
- SPI_Glcd_Rectangle
- SPI_Glcd_Box
- SPI_Glcd_Circle
- SPI_Glcd_Set_Font
- SPI_Glcd_Write_Char
- SPI_Glcd_Write_Text
- SPI_Glcd_Image

SPI_Glcd_Init

Prototype	<code>sub procedure SPI_Glcd_Init(dim DeviceAddress as byte)</code>
Returns	Nothing.
Description	<p>Initializes the Glcd module via SPI interface.</p> <p>Parameters :</p> <ul style="list-style-type: none"> - <code>DeviceAddress</code>: SPI expander hardware address, see schematic at the bottom of this page
Requires	<p>Global variables :</p> <ul style="list-style-type: none"> - <code>SPExpanderCS</code>: Chip Select line - <code>SPExpanderRST</code>: Reset line - <code>SPExpanderCS_Direction</code>: Direction of the Chip Select pin - <code>SPExpanderRST_Direction</code>: Direction of the Reset pin <p>must be defined before using this function.</p> <p>SPI module needs to be initialized. See <code>SPI1_Init</code> and <code>SPI1_Init_Advanced</code> routines.</p>
Example	<pre>' port expander pinout definition dim SPExpanderCS as sbit at PORTB.B1 SPExpanderRST as sbit at PORTB.B0 SPExpanderCS_Direction as sbit at DDRB.B1 SPExpanderRST_Direction as sbit at DDRB.B0 ... ' If Port Expander Library uses SPI1 module : SPI1_Init_Advanced(_SPI_MASTER, _SPI_FCY_DIV2, _SPI_CLK_HI_TRAILING) ' Initialize SPI module used with PortExpander SPI_Rd_Ptr = @SPI1_Read ' Pass pointer to SPI Read function of used SPI module SPI_Glcd_Init(0)</pre>

SPI_Glcd_Set_Side

Prototype	<code>sub procedure SPI_Glcd_Set_Side(dim x_pos as byte)</code>
Returns	Nothing.
Description	<p>Selects Glcd side. Refer to the Glcd datasheet for detail explanation.</p> <p>Parameters :</p> <p>- <code>x_pos</code>: position on x-axis. Valid values: 0..127</p> <p>The parameter <code>x_pos</code> specifies the Glcd side: values from 0 to 63 specify the left side, values from 64 to 127 specify the right side.</p> <p>Note: For side, x axis and page layout explanation see schematic at the bottom of this page.</p>
Requires	Glcd needs to be initialized for SPI communication, see SPI_Glcd_Init routines.
Example	<p>The following two lines are equivalent, and both of them select the left side of Glcd:</p> <pre>SPI_Glcd_Set_Side(0) SPI_Glcd_Set_Side(10)</pre>

SPI_Glcd_Set_Page

Prototype	<code>sub procedure SPI_Glcd_Set_Page(dim page as byte)</code>
Returns	Nothing.
Description	<p>Selects page of Glcd.</p> <p>Parameters :</p> <p>- <code>page</code>: page number. Valid values: 0..7</p> <p>Note: For side, x axis and page layout explanation see schematic at the bottom of this page.</p>
Requires	Glcd needs to be initialized for SPI communication, see SPI_Glcd_Init routines.
Example	<code>SPI_Glcd_Set_Page(5)</code>

SPI_Glcd_Set_X

Prototype	<code>sub procedure SPI_Glcd_Set_X(dim x_pos as byte)</code>
Returns	Nothing.
Description	<p>Sets x-axis position to x_pos dots from the left border of Glcd within the selected side.</p> <p>Parameters :</p> <p>- x_pos: position on x-axis. Valid values: 0..63</p> <p>Note: For side, x axis and page layout explanation see schematic at the bottom of this page.</p>
Requires	Glcd needs to be initialized for SPI communication, see SPI_Glcd_Init routines.
Example	<code>SPI_Glcd_Set_X(25)</code>

SPI_Glcd_Read_Data

Prototype	<code>sub function SPI_Glcd_Read_Data() as byte</code>
Returns	One byte from Glcd memory.
Description	Reads data from the current location of Glcd memory and moves to the next location.
Requires	<p>Glcd needs to be initialized for SPI communication, see SPI_Glcd_Init routines.</p> <p>Glcd side, x-axis position and page should be set first. See the functions SPI_Glcd_Set_Side, SPI_Glcd_Set_X, and SPI_Glcd_Set_Page.</p>
Example	<pre>dim data as byte ... data = SPI_Glcd_Read_Data()</pre>

SPI_Glcd_Write_Data

Prototype	<code>sub procedure SPI_Glcd_Write_Data(dim Ddata as byte)</code>
Returns	Nothing.
Description	Writes one byte to the current location in Glcd memory and moves to the next location. Parameters : - <code>Ddata</code> : data to be written
Requires	Glcd needs to be initialized for SPI communication, see <code>SPI_Glcd_Init</code> routines. Glcd side, x-axis position and page should be set first. See the functions <code>SPI_Glcd_Set_Side</code> , <code>SPI_Glcd_Set_X</code> , and <code>SPI_Glcd_Set_Page</code> .
Example	<pre>dim ddata as byte ... SPI_Glcd_Write_Data(ddata)</pre>

SPI_Glcd_Fill

Prototype	<code>sub procedure SPI_Glcd_Fill(dim pattern as byte)</code>
Returns	Nothing.
Description	Fills Glcd memory with byte <code>pattern</code> . Parameters : - <code>pattern</code> : byte to fill Glcd memory with To clear the Glcd screen, use <code>SPI_Glcd_Fill(0)</code> . To fill the screen completely, use <code>SPI_Glcd_Fill(0xFF)</code> .
Requires	Glcd needs to be initialized for SPI communication, see <code>SPI_Glcd_Init</code> routines.
Example	<pre>' Clear screen SPI_Glcd_Fill(0)</pre>

SPI_Glcd_Dot

Prototype	<code>sub procedure SPI_Glcd_Dot(dim x_pos as byte, dim y_pos as byte, dim color as byte)</code>
Returns	Nothing.
Description	<p>Draws a dot on Glcd at coordinates (<code>x_pos</code>, <code>y_pos</code>).</p> <p>Parameters :</p> <ul style="list-style-type: none"> - <code>x_pos</code>: x position. Valid values: 0..127 - <code>y_pos</code>: y position. Valid values: 0..63 - <code>color</code>: <code>colx_pos as byte</code>; <code>page_num as byte</code>; <code>color as byte</code>) or parameter. Valid values: 0..2 <p>The parameter <code>color</code> determines the dot state: 0 clears dot, 1 puts a dot, and 2 inverts dot state.</p> <p>Note: For x and y axis layout explanation see schematic at the bottom of this page.</p>
Requires	Glcd needs to be initialized for SPI communication, see <code>SPI_Glcd_Init</code> routines.
Example	<code>' Invert the dot in the upper left corner SPI_Glcd_Dot(0, 0, 2)</code>

SPI_Glcd_Line

Prototype	<code>sub procedure SPI_Glcd_Line(dim x_start as integer, dim y_start as integer, dim x_end as integer, dim y_end as integer, dim color as byte)</code>
Returns	Nothing.
Description	<p>Draws a line on Glcd.</p> <p>Parameters :</p> <ul style="list-style-type: none"> - <code>x_start</code>: x coordinate of the line start. Valid values: 0..127 - <code>y_start</code>: y coordinate of the line start. Valid values: 0..63 - <code>x_end</code>: x coordinate of the line end. Valid values: 0..127 - <code>y_end</code>: y coordinate of the line end. Valid values: 0..63 - <code>color</code>: color parameter. Valid values: 0..2 <p>Parameter <code>color</code> determines the line color: 0 white, 1 black, and 2 inverts each dot.</p>
Requires	Glcd needs to be initialized for SPI communication, see <code>SPI_Glcd_Init</code> routines.
Example	<code>' Draw a line between dots (0,0) and (20,30) SPI_Glcd_Line(0, 0, 20, 30, 1)</code>

SPI_Glcd_V_Line

Prototype	<code>sub procedure SPI_Glcd_V_Line(dim y_start as byte, dim y_end as byte, dim x_pos as byte, dim color as byte)</code>
Returns	Nothing.
Description	<p>Draws a vertical line on Glcd.</p> <p>Parameters :</p> <ul style="list-style-type: none"> - <code>y_start</code>: y coordinate of the line start. Valid values: 0..63 - <code>y_end</code>: y coordinate of the line end. Valid values: 0..63 - <code>x_pos</code>: x coordinate of vertical line. Valid values: 0..127 - <code>color</code>: color parameter. Valid values: 0..2 <p>Parameter color determines the line color: 0 white, 1 black, and 2 inverts each dot.</p>
Requires	Glcd needs to be initialized for SPI communication, see SPI_Glcd_Init routines.
Example	<code>' Draw a vertical line between dots (10,5) and (10,25)</code> <code>SPI_Glcd_V_Line(5, 25, 10, 1)</code>

SPI_Glcd_H_Line

Prototype	<code>sub procedure SPI_Glcd_V_Line(dim x_start as byte, dim x_end as byte, dim y_pos as byte, dim color as byte)</code>
Returns	Nothing.
Description	<p>Draws a horizontal line on Glcd.</p> <p>Parameters :</p> <ul style="list-style-type: none"> - <code>x_start</code>: x coordinate of the line start. Valid values: 0..127 - <code>x_end</code>: x coordinate of the line end. Valid values: 0..127 - <code>y_pos</code>: y coordinate of horizontal line. Valid values: 0..63 - <code>color</code>: color parameter. Valid values: 0..2 <p>The parameter color determines the line color: 0 white, 1 black, and 2 inverts each dot.</p>
Requires	Glcd needs to be initialized for SPI communication, see SPI_Glcd_Init routines.
Example	<code>' Draw a horizontal line between dots (10,20) and (50,20)</code> <code>SPI_Glcd_H_Line(10, 50, 20, 1)</code>

SPI_Glcd_Rectangle

Prototype	<code>sub procedure SPI_Glcd_Rectangle(dim x_upper_left as byte, dim y_upper_left as byte, dim x_bottom_right as byte, dim y_bottom_right as byte, dim color as byte)</code>
Returns	Nothing.
Description	<p>Draws a rectangle on Glcd.</p> <p>Parameters :</p> <ul style="list-style-type: none"> - <code>x_upper_left</code>: x coordinate of the upper left rectangle corner. Valid values: 0..127 - <code>y_upper_left</code>: y coordinate of the upper left rectangle corner. Valid values: 0..63 - <code>x_bottom_right</code>: x coordinate of the lower right rectangle corner. Valid values: 0..127 - <code>y_bottom_right</code>: y coordinate of the lower right rectangle corner. Valid values: 0..63 - <code>color</code>: color parameter. Valid values: 0..2 <p>The parameter <code>color</code> determines the color of the rectangle border: 0 white, 1 black, and 2 inverts each dot.</p>
Requires	Glcd needs to be initialized for SPI communication, see SPI_Glcd_Init routines.
Example	<code>' Draw a rectangle between dots (5,5) and (40,40) SPI_Glcd_Rectangle(5, 5, 40, 40, 1)</code>

SPI_Glcd_Box

Prototype	<code>sub procedure SPI_Glcd_Box(dim x_upper_left as byte, dim y_upper_left as byte, dim x_bottom_right as byte, dim y_bottom_right as byte, dim color as byte)</code>
Returns	Nothing.
Description	<p>Draws a box on Glcd.</p> <p>Parameters :</p> <ul style="list-style-type: none">- <code>x_upper_left</code>: x coordinate of the upper left box corner. Valid values: 0..127- <code>y_upper_left</code>: y coordinate of the upper left box corner. Valid values: 0..63- <code>x_bottom_right</code>: x coordinate of the lower right box corner. Valid values: 0..127- <code>y_bottom_right</code>: y coordinate of the lower right box corner. Valid values: 0..63- <code>color</code>: color parameter. Valid values: 0..2 <p>The parameter <code>color</code> determines the color of the box fill: 0 white, 1 black, and 2 inverts each dot.</p>
Requires	Glcd needs to be initialized for SPI communication, see SPI_Glcd_Init routines.
Example	<pre>' Draw a box between dots (5,15) and (20,40) SPI_Glcd_Box(5, 15, 20, 40, 1)</pre>

SPI_Glcd_Circle

Prototype	<code>sub procedure SPI_Glcd_Circle(dim x_center as integer, dim y_center as integer, dim radius as integer, dim color as byte)</code>
Returns	Nothing.
Description	<p>Draws a circle on Glcd.</p> <p>Parameters :</p> <ul style="list-style-type: none">- <code>x_center</code>: x coordinate of the circle center. Valid values: 0..127- <code>y_center</code>: y coordinate of the circle center. Valid values: 0..63- <code>radius</code>: radius size- <code>color</code>: color parameter. Valid values: 0..2 <p>The parameter <code>color</code> determines the color of the circle line: 0 white, 1 black, and 2 inverts each dot.</p>
Requires	Glcd needs to be initialized for SPI communication, see SPI_Glcd_Init routine.
Example	<pre>' Draw a circle with center in (50,50) and radius=10 SPI_Glcd_Circle(50, 50, 10, 1)</pre>

SPI_Glcd_Set_Font

Prototype	<code>sub procedure SPI_Glcd_Set_Font(dim activeFont as longint, dim aFontWidth as byte, dim aFontHeight as byte, dim aFontOffs as word)</code>
Returns	Nothing.
Description	<p>Sets font that will be used with SPI_Glcd_Write_Char and SPI_Glcd_Write_Text routines.</p> <p>Parameters :</p> <ul style="list-style-type: none"> - <code>activeFont</code>: font to be set. Needs to be formatted as an array of char - <code>aFontWidth</code>: width of the font characters in dots. - <code>aFontHeight</code>: height of the font characters in dots. - <code>aFontOffs</code>: number that represents difference between the mikroBasic PRO character set and regular ASCII set (eg. if 'A' is 65 in ASCII character, and 'A' is 45 in the mikroBasic PRO character set, aFontOffs is 20). Demo fonts supplied with the library have an offset of 32, which means that they start with space. <p>The user can use fonts given in the file “__Lib_GLCD_fonts.mbas” file located in the Uses folder or create his own fonts.</p>
Requires	Glcd needs to be initialized for SPI communication, see SPI_Glcd_Init routines.
Example	<code>' Use the custom 5x7 font "myfont" which starts with space (32): SPI_Glcd_Set_Font(@myfont, 5, 7, 32)</code>

SPI_Glcd_Write_Char

Prototype	<code>sub procedure SPI_Glcd_Write_Char(dim chr1 as byte, dim x_pos as byte, dim page_num as byte, dim color as byte)</code>
Returns	Nothing.
Description	<p>Prints character on Glcd.</p> <p>Parameters :</p> <ul style="list-style-type: none"> - <code>chr1</code>: character to be written - <code>x_pos</code>: character starting position on x-axis. Valid values: 0..(127-FontWidth) - <code>page_num</code>: the number of the page on which character will be written. Valid values: 0..7 - <code>color</code>: color parameter. Valid values: 0..2 <p>The parameter <code>color</code> determines the color of the character: 0 white, 1 black, and 2 inverts each dot.</p> <p>Note: For x axis and page layout explanation see schematic at the bottom of this page.</p>
Requires	<p>Glcd needs to be initialized for SPI communication, see SPI_Glcd_Init routines.</p> <p>Use the SPI_Glcd_Set_Font to specify the font for display; if no font is specified, then the default 5x8 font supplied with the library will be used.</p>
Example	<pre>' Write character 'C' on the position 10 inside the page 2: SPI_Glcd_Write_Char("C", 10, 2, 1)</pre>

SPI_Glcd_Write_Text

Prototype	<code>sub procedure SPI_Glcd_Write_Text(dim byref text as string[40] , dim x_pos as byte, dim page_num as byte, dim color as byte)</code>
Returns	Nothing.
Description	<p>Prints text on Glcd.</p> <p>Parameters :</p> <ul style="list-style-type: none"> - <code>text</code>: text to be written - <code>x_pos</code>: text starting position on x-axis. - <code>page_num</code>: the number of the page on which text will be written. Valid values: 0..7 - <code>color</code>: color parameter. Valid values: 0..2 <p>The parameter <code>color</code> determines the color of the text: 0 white, 1 black, and 2 inverts each dot.</p> <p>Note: For x axis and page layout explanation see schematic at the bottom of this page.</p>
Requires	<p>Glcd needs to be initialized for SPI communication, see SPI_Glcd_Init routines.</p> <p>Use the SPI_Glcd_Set_Font to specify the font for display; if no font is specified, then the default 5x8 font supplied with the library will be used.</p>
Example	<code>' Write text "Hello world!" on the position 10 inside the page 2: SPI_Glcd_Write_Text("Hello world!", 10, 2, 1)</code>

SPI_Glcd_Image

Prototype	<code>sub procedure SPI_Glcd_Image(dim const image as ^byte)</code>
Returns	Nothing.
Description	<p>Displays bitmap on Glcd.</p> <p>Parameters :</p> <ul style="list-style-type: none"> - <code>image</code>: image to be displayed. Bitmap array can be located in both code and RAM memory (due to the mikroBasic PRO for AVR pointer to const and pointer to RAM equivalency). <p>Use the mikroBasic PRO's integrated Glcd Bitmap Editor (menu option Tools › Glcd Bitmap Editor) to convert image to a constant array suitable for displaying on Glcd.</p>
Requires	Glcd needs to be initialized for SPI communication, see SPI_Glcd_Init routines.
Example	<pre>' Draw image my_image on Glcd SPI_Glcd_Image(my_image)</pre>

Library Example

The example demonstrates how to communicate to KS0108 Glcd via the SPI module, using serial to parallel convertor MCP23S17.

```
program SPI_Glcd

include bitmap

' Port Expander module connections
dim SPExpanderRST as sbit at PORTB.0
   SPExpanderCS   as sbit at PORTB.1
   SPExpanderRST_Direction as sbit at DDRB.0
   SPExpanderCS_Direction  as sbit at DDRB.1
' End Port Expander module connections

dim someText as char[20]
   counter as byte

sub procedure Delay2S
   delay_ms(2000)
end sub
```

```

main:
  ' If Port Expander Library uses SPI1 module
  SPI1_Init_Advanced(_SPI_MASTER, _SPI_FCY_DIV2, _SPI_CLK_HI_TRAIL-
ING) ' Initialize SPI module used with PortExpander
  Spi_Rd_Ptr = @SPI1_Read ' Pass pointer to
SPI Read sub function of used SPI module

  ' ' If Port Expander Library uses SPI2 module
  ' SPI2_Init_Advanced(_SPI_MASTER, _SPI_FCY_DIV2,
_SPI_CLK_HI_TRAILING) ' Initialize SPI module used with PortExpander
  ' Spi_Rd_Ptr = @SPI2_Read ' Pass pointer to
SPI Read sub function of used SPI module

  SPI_Glcd_Init(0) ' Initialize Glcd
via SPI
  SPI_Glcd_Fill(0x00) ' Clear Glcd

  while TRUE
    SPI_Glcd_Image(@truck_bmp) ' Draw image
    Delay2s() Delay2s()

    SPI_Glcd_Fill(0x00) ' Clear Glcd
    Delay2s

    SPI_Glcd_Box(62,40,124,56,1) ' Draw box
    SPI_Glcd_Rectangle(5,5,84,35,1) ' Draw rectangle
    SPI_Glcd_Line(0, 63, 127, 0,1) ' Draw line
    Delay2s()
    counter = 5
    while (counter < 60) ' Draw horizontal
and vertical line
      Delay_ms(250)
      SPI_Glcd_V_Line(2, 54, counter, 1)
      SPI_Glcd_H_Line(2, 120, counter, 1)
      counter = counter + 5
    wend
    Delay2s()

    SPI_Glcd_Fill(0x00) ' Clear Glcd
    SPI_Glcd_Set_Font(@Character8x7, 8, 8, 32) ' Choose font
"Character8x7"
    SPI_Glcd_Write_Text("mikroE", 5, 7, 2) ' Write string

    for counter = 1 to 10 ' Draw circles
      SPI_Glcd_Circle(63,32, 3*counter, 1)
    next counter
    Delay2s()

    SPI_Glcd_Box(12,20, 70,63, 2) ' Draw box
    Delay2s()

```

```
SPI_Glcd_Fill(0xFF)           ' Fill Glcd

SPI_Glcd_Set_Font(@Character8x7, 8, 7, 32) ' Change font
someText = "8x7 Font"
SPI_Glcd_Write_Text(someText, 5, 1, 2)   ' Write string
Delay2s()

SPI_Glcd_Set_Font(@System3x6, 3, 5, 32)  ' Change font
someText = "3X5 CAPITALS ONLY"
SPI_Glcd_Write_Text(someText, 5, 3, 2)   ' Write string
Delay2s()

SPI_Glcd_Set_Font(@font5x7, 5, 7, 32)    ' Change font
someText = "5x7 Font"
SPI_Glcd_Write_Text(someText, 5, 5, 2)   ' Write string
Delay2s()

SPI_Glcd_Set_Font(@FontSystem5x7_v2, 5, 7, 32) ' Change font
someText = "5x7 Font (v2)"
SPI_Glcd_Write_Text(someText, 5, 7, 2)   ' Write string
Delay2s()
wend
end.
```

HW Connection

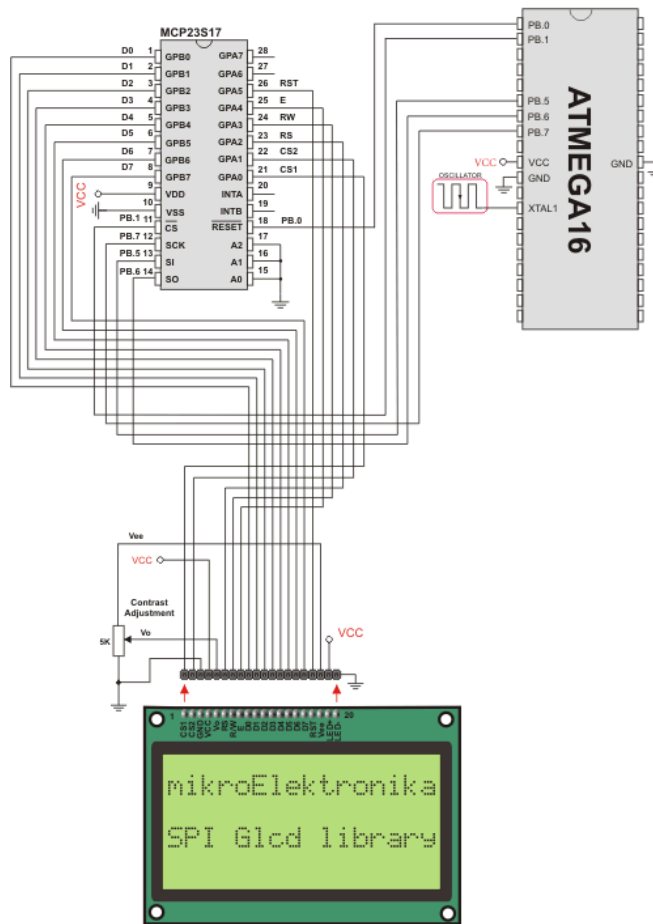
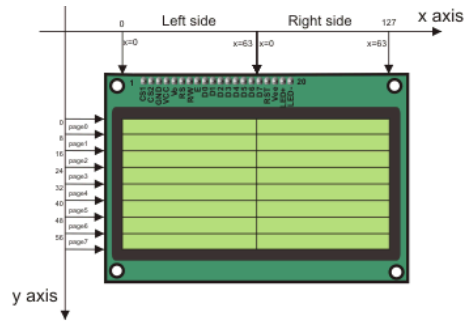

SPI Glcd HW connection

SPI LCD LIBRARY

The mikroBasic PRO for AVR provides a library for communication with Lcd (with HD44780 compliant controllers) in 4-bit mode via SPI interface.

For creating a custom set of Lcd characters use Lcd Custom Character Tool.

Note: The library uses the SPI module for communication. The user must initialize the SPI module before using the SPI Lcd Library.

Note: This Library is designed to work with the mikroElektronika's Serial Lcd Adapter Board pinout. See schematic at the bottom of this page for details.

External dependencies of SPI Lcd Library

The implementation of SPI Lcd Library routines is based on Port Expander Library routines.

Prior to calling any of this library routines, Spi_Rd_Ptr needs to be initialized with the appropriate SPI_Read routine.

External dependencies are the same as Port Expander Library external dependencies.

Library Routines

- SPI_Lcd_Config
- SPI_Lcd_Out
- SPI_Lcd_Out_Cp
- SPI_Lcd_Chr
- SPI_Lcd_Chr_Cp
- SPI_Lcd_Cmd

SPI_Lcd_Config

Prototype	<code>sub procedure SPI_Lcd_Config(dim DeviceAddress as byte)</code>
Returns	Nothing.
Description	<p>Initializes the Lcd module via SPI interface.</p> <p>Parameters :</p> <ul style="list-style-type: none"> - <code>DeviceAddress</code>: spi expander hardware address, see schematic at the bottom of this page
Requires	<p>Global variables :</p> <ul style="list-style-type: none"> - <code>SPExpanderCS</code>: Chip Select line - <code>SPExpanderRST</code>: Reset line - <code>SPExpanderCS_Direction</code>: Direction of the Chip Select pin - <code>SPExpanderRST_Direction</code>: Direction of the Reset pin <p>must be defined before using this function.</p> <p>SPI module needs to be initialized. See <code>SPI1_Init</code> and <code>SPI1_Init_Advanced</code> routines.</p>
Example	<pre>' port expander pinout definition dim SPExpanderCS as sbit at PORTB.B1 SPExpanderRST as sbit at PORTB.B0 SPExpanderCS_Direction as sbit at DDRB.B1 SPExpanderRST_Direction as sbit at DDRB.B0 ... ' If Port Expander Library uses SPI1 module SPI1_Init() ' Initialize SPI module used with PortExpander Spi_Rd_Ptr = @SPI1_Read ' Pass pointer to SPI Read func- tion of used SPI module SPI_Lcd_Config(0) ' initialize lcd over spi inter- face</pre>

SPI_Lcd_Out

Prototype	<code>sub procedure SPI_Lcd_Out(dim row as byte, dim column as byte, dim byref text as string[20])</code>
Returns	Nothing.
Description	<p>Prints text on the Lcd starting from specified position. Both string variables and literals can be passed as a text.</p> <p>Parameters :</p> <ul style="list-style-type: none"> - <code>row</code>: starting position row number - <code>column</code>: starting position column number - <code>text</code>: text to be written
Requires	Lcd needs to be initialized for SPI communication, see SPI_Lcd_Config routines.
Example	' Write text "Hello!" on Lcd starting from row 1, column 3: <code>SPI_Lcd_Out(1, 3, "Hello!")</code>

SPI_Lcd_Out_Cp

Prototype	<code>sub procedure SPI_Lcd_Out_CP(dim text as string[19])</code>
Returns	Nothing.
Description	<p>Prints text on the Lcd at current cursor position. Both string variables and literals can be passed as a text.</p> <p>Parameters :</p> <ul style="list-style-type: none"> - <code>text</code>: text to be written
Requires	Lcd needs to be initialized for SPI communication, see SPI_Lcd_Config routines.
Example	' Write text "Here!" at current cursor position: <code>SPI_Lcd_Out_CP("Here!")</code>

SPI_Lcd_Chr

Prototype	<code>sub procedure SPI_Lcd_Chr(dim Row as byte, dim Column as byte, dim Out_Char as byte)</code>
Returns	Nothing.
Description	Prints character on Lcd at specified position. Both variables and literals can be passed as character. Parameters : - <code>Row</code> : writing position row number - <code>Column</code> : writing position column number - <code>Out_Char</code> : character to be written
Requires	Lcd needs to be initialized for SPI communication, see SPI_Lcd_Config routines.
Example	<code>' Write character "i" at row 2, column 3: SPI_Lcd_Chr(2, 3, 'i')</code>

SPI_Lcd_Chr_Cp

Prototype	<code>sub procedure SPI_Lcd_Chr_CP(dim Out_Char as byte)</code>
Returns	Nothing.
Description	Prints character on Lcd at current cursor position. Both variables and literals can be passed as character. Parameters : - <code>Out_Char</code> : character to be written
Requires	Lcd needs to be initialized for SPI communication, see SPI_Lcd_Config routines.
Example	<code>' Write character "e" at current cursor position: SPI_Lcd_Chr_Cp('e')</code>

SPI_Lcd_Cmd

Prototype	<code>sub procedure SPI_Lcd_Cmd(dim out_char as byte)</code>
Returns	Nothing.
Description	<p>Sends command to Lcd.</p> <p>Parameters :</p> <p>- <code>out_char</code>: command to be sent</p> <p>Note: Predefined constants can be passed to the function, see Available SPI Lcd Commands.</p>
Requires	Lcd needs to be initialized for SPI communication, see SPI_Lcd_Config routines.
Example	<pre>' Clear Lcd display: SPI_Lcd_Cmd(LCD_CLEAR)</pre>

Available SPI Lcd Commands

Lcd Command	Purpose
<code>LCD_FIRST_ROW</code>	Move cursor to the 1st row
<code>LCD_SECOND_ROW</code>	Move cursor to the 2nd row
<code>LCD_THIRD_ROW</code>	Move cursor to the 3rd row
<code>LCD_FOURTH_ROW</code>	Move cursor to the 4th row
<code>LCD_CLEAR</code>	Clear display
<code>LCD_RETURN_HOME</code>	Return cursor to home position, returns a shifted display to its original position. Display data RAM is unaffected.
<code>LCD_CURSOR_OFF</code>	Turn off cursor
<code>LCD_UNDERLINE_ON</code>	Underline cursor on
<code>LCD_BLINK_CURSOR_ON</code>	Blink cursor on
<code>LCD_MOVE_CURSOR_LEFT</code>	Move cursor left without changing display data RAM
<code>LCD_MOVE_CURSOR_RIGHT</code>	Move cursor right without changing display data RAM
<code>LCD_TURN_ON</code>	Turn Lcd display on
<code>LCD_TURN_OFF</code>	Turn Lcd display off
<code>LCD_SHIFT_LEFT</code>	Shift display left without changing display data RAM
<code>LCD_SHIFT_RIGHT</code>	Shift display right without changing display data RAM

Library Example

This example demonstrates how to communicate Lcd via the SPI module, using serial to parallel convertor MCP23S17.

```

program Spi_Lcd

dim text as char[17]

' Port Expander module connections
dim SPExpanderRST as sbit at PORTB.B0
    SPExpanderCS as sbit at PORTB.B1
    SPExpanderRST_Direction as sbit at DDRB.B0
    SPExpanderCS_Direction as sbit at DDRB.B1
' End Port Expander module connections

main:
    text = "mikroElektronika"
    ' If Port Expander Library uses SPI1 module
    SPI1_Init() ' Initialize SPI module
used with PortExpander
    Spi_Rd_Ptr = @SPI1_Read ' Pass pointer to SPI Read
sub function of used SPI module

    ' If Port Expander Library uses SPI2 module
    ' SPI2_Init() ' Initialize SPI module
used with PortExpander
    ' Spi_Rd_Ptr = &SPI2_Read ' Pass pointer to SPI Read
sub function of used SPI module
    SPI_Lcd_Config(0) ' Initialize Lcd over SPI
interface
    SPI_Lcd_Cmd(LCD_CLEAR) ' Clear display
    SPI_Lcd_Cmd(LCD_CURSOR_OFF) ' Turn cursor off
    SPI_Lcd_Out(1,6, "mikroE") ' Print text to Lcd, 1st
row, 6th column
    SPI_Lcd_Chr_CP("!") ' Append "!"
    SPI_Lcd_Out(2,1, text) ' Print text to Lcd, 2nd
row, 1st column
end.

```

HW Connection

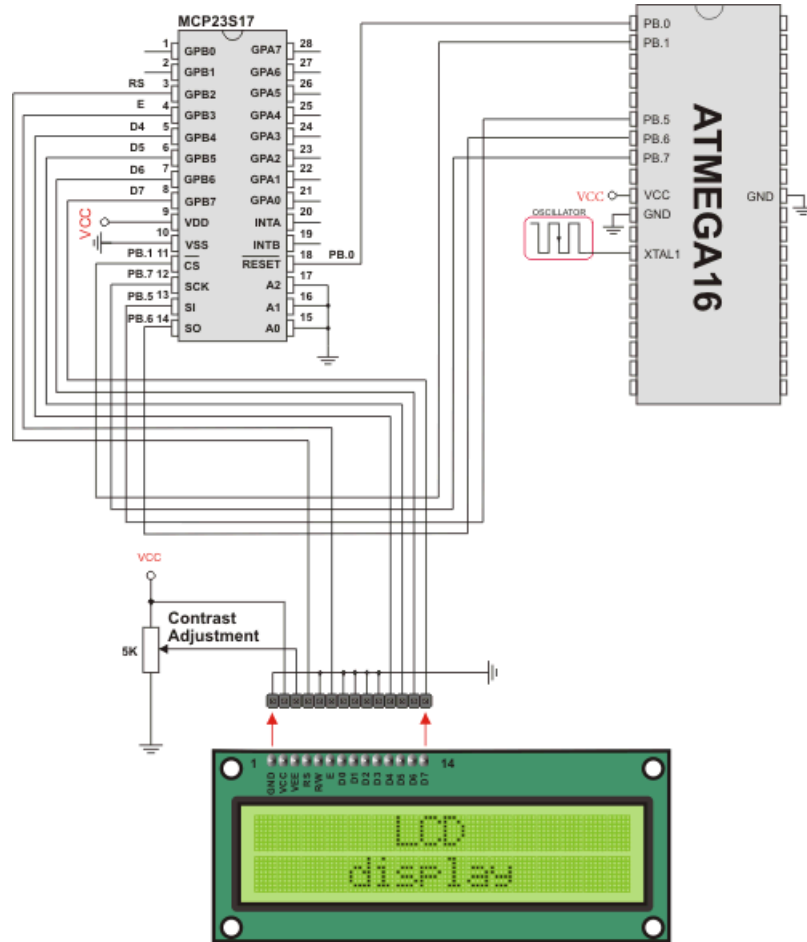

SPI Lcd HW connection

SPI LCD8 (8-BIT INTERFACE) LIBRARY

The mikroBasic PRO for AVR provides a library for communication with Lcd (with HD44780 compliant controllers) in 8-bit mode via SPI interface.

For creating a custom set of Lcd characters use Lcd Custom Character Tool.

Note: Library uses the SPI module for communication. The user must initialize the SPI module before using the SPI Lcd Library.

Note: This Library is designed to work with mikroElektronika's Serial Lcd/Glcd Adapter Board pinout, see schematic at the bottom of this page for details.

External dependencies of SPI Lcd Library

The implementation of SPI Lcd Library routines is based on Port Expander Library routines.

Prior to calling any of this library routines, Spi_Rd_Ptr needs to be initialized with the appropriate SPI_Read routine.

External dependencies are the same as Port Expander Library external dependencies.

Library Routines

- SPI_Lcd8_Config
- SPI_Lcd8_Out
- SPI_Lcd8_Out_Cp
- SPI_Lcd8_Chr
- SPI_Lcd8_Chr_Cp
- SPI_Lcd8_Cmd

SPI_Lcd8_Config

Prototype	<code>sub procedure SPI_Lcd8_Config(dim DeviceAddress as byte)</code>
Returns	Nothing.
Description	<p>Initializes the Lcd module via SPI interface.</p> <p>Parameters :</p> <ul style="list-style-type: none"> - <code>DeviceAddress</code>: spi expander hardware address, see schematic at the bottom of this page
Requires	<p>Global variables :</p> <ul style="list-style-type: none"> - <code>SPExpanderCS</code>: Chip Select line - <code>SPExpanderRST</code>: Reset line - <code>SPExpanderCS_Direction</code>: Direction of the Chip Select pin - <code>SPExpanderRST_Direction</code>: Direction of the Reset pin <p>must be defined before using this function.</p> <p>SPI module needs to be initialized. See <code>SPI1_Init</code> and <code>SPI1_Init_Advanced</code> routines.</p>
Example	<pre>' port expander pinout definition dim SPExpanderCS as sbit at PORTB.B1 SPExpanderRST as sbit at PORTB.B0 SPExpanderCS_Direction as sbit at DDRB.B1 SPExpanderRST_Direction as sbit at DDRB.B0 ... Spi1_Init() ' Initialize spi interface Spi_Rd_Ptr = @SPI1_Read ' Pass pointer to SPI_Read function of used SPI module SPI_Lcd8_Config(0) ' Intialize lcd in 8bit mode via spi</pre>

SPI_Lcd8_Out

Prototype	<code>sub procedure SPI_Lcd8_Out(dim row as byte, dim column as byte, dim byref text as string[19])</code>
Returns	Nothing.
Description	Prints text on Lcd starting from specified position. Both string variables and literals can be passed as a text. Parameters : - <code>row</code> : starting position row number - <code>column</code> : starting position column number - <code>text</code> : text to be written
Requires	Lcd needs to be initialized for SPI communication, see SPI_Lcd8_Config routines.
Example	' Write text "Hello!" on Lcd starting from row 1, column 3: <code>SPI_Lcd8_Out(1, 3, "Hello!")</code>

SPI_Lcd8_Out_Cp

Prototype	<code>sub procedure SPI_Lcd8_Out_CP(dim text as string[19])</code>
Returns	Nothing.
Description	Prints text on Lcd at current cursor position. Both string variables and literals can be passed as a text. Parameters : - <code>text</code> : text to be written
Requires	Lcd needs to be initialized for SPI communication, see SPI_Lcd8_Config routines.
Example	' Write text "Here!" at current cursor position: <code>SPI_Lcd8_Out_CP("Here!")</code>

SPI_Lcd8_Chr

Prototype	<code>sub procedure SPI_Lcd8_Chr(dim Row as byte, dim Column as byte, dim Out_Char as byte)</code>
Returns	Nothing.
Description	<p>Prints character on Lcd at specified position. Both variables and literals can be passed as character.</p> <p>Parameters :</p> <ul style="list-style-type: none"> - <code>row</code>: writing position row number - <code>column</code>: writing position column number - <code>out_char</code>: character to be written
Requires	Lcd needs to be initialized for SPI communication, see SPI_Lcd8_Config routines.
Example	<pre>' Write character "i" at row 2, column 3: SPI_Lcd8_Chr(2, 3, 'i')</pre>

SPI_Lcd8_Chr_Cp

Prototype	<code>sub procedure SPI_Lcd8_Chr_CP(dim Out_Char as byte)</code>
Returns	Nothing.
Description	<p>Prints character on Lcd at current cursor position. Both variables and literals can be passed as character.</p> <p>Parameters :</p> <ul style="list-style-type: none"> - <code>out_char</code>: character to be written
Requires	Lcd needs to be initialized for SPI communication, see SPI_Lcd8_Config routines.
Example	<p>Print "e" at current cursor position:</p> <pre>' Write character "e" at current cursor position: SPI_Lcd8_Chr_Cp('e')</pre>

SPI_Lcd8_Cmd

Prototype	<code>sub procedure SPI_Lcd8_Cmd(dim out_char as byte)</code>
Returns	Nothing.
Description	<p>Sends command to Lcd.</p> <p>Parameters :</p> <p>- <code>out_char</code>: command to be sent</p> <p>Note: Predefined constants can be passed to the function, see Available SPI Lcd8 Commands.</p>
Requires	Lcd needs to be initialized for SPI communication, see SPI_Lcd8_Config routines.
Example	<pre>' Clear Lcd display: SPI_Lcd8_Cmd(LCD_CLEAR)</pre>

Available SPI Lcd8 Commands

Lcd Command	Purpose
<code>LCD_FIRST_ROW</code>	Move cursor to the 1st row
<code>LCD_SECOND_ROW</code>	Move cursor to the 2nd row
<code>LCD_THIRD_ROW</code>	Move cursor to the 3rd row
<code>LCD_FOURTH_ROW</code>	Move cursor to the 4th row
<code>LCD_CLEAR</code>	Clear display
<code>LCD_RETURN_HOME</code>	Return cursor to home position, returns a shifted display to its original position. Display data RAM is unaffected.
<code>LCD_CURSOR_OFF</code>	Turn off cursor
<code>LCD_UNDERLINE_ON</code>	Underline cursor on
<code>LCD_BLINK_CURSOR_ON</code>	Blink cursor on
<code>LCD_MOVE_CURSOR_LEFT</code>	Move cursor left without changing display data RAM
<code>LCD_MOVE_CURSOR_RIGHT</code>	Move cursor right without changing display data RAM
<code>LCD_TURN_ON</code>	Turn Lcd display on
<code>LCD_TURN_OFF</code>	Turn Lcd display off
<code>LCD_SHIFT_LEFT</code>	Shift display left without changing display data RAM
<code>LCD_SHIFT_RIGHT</code>	Shift display right without changing display data RAM

Library Example

This example demonstrates how to communicate Lcd in 8-bit mode via the SPI module, using serial to parallel convertor MCP23S17.

```
program Spi_Lcd8_Test

dim text as char[16]

' Port Expander module connections
dim SPExpanderRST as sbit at PORTB.0
  SPExpanderCS as sbit at PORTB.1
  SPExpanderRST_Direction as sbit at DDRB.0
  SPExpanderCS_Direction as sbit at DDRB.1
' End Port Expander module connections

main:
  text = "mikroE"
  ' If Port Expander Library uses SPI1 module
  SPI1_Init() ' Initialize SPI mod-
ule used with PortExpander
  Spi_Rd_Ptr = @SPI1_Read ' Pass pointer to SPI
Read sub function of used SPI module

  ' ' If Port Expander Library uses SPI2 module
  ' SPI2_Init() ' Initialize SPI mod-
ule used with PortExpander
  ' Spi_Rd_Ptr = &SPI2_Read ' Pass pointer to SPI
Read sub function of used SPI module

  SPI_Lcd8_Config(0) ' Intialize Lcd in
8bit mode via SPI
  SPI_Lcd8_Cmd(LCD_CLEAR) ' Clear display
  SPI_Lcd8_Cmd(LCD_CURSOR_OFF) ' Turn cursor off
  SPI_Lcd8_Out(1,6, text) ' Print text to Lcd,
1st row, 6th column...
  SPI_Lcd8_Chr_CP("!") ' Append "!"
  SPI_Lcd8_Out(2,1, "mikroelektronika") ' Print text to Lcd,
2nd row, 1st column...
  SPI_Lcd8_Out(3,1, text) ' For Lcd modules with
more than two rows
  SPI_Lcd8_Out(4,15, text) ' For Lcd modules with
more than two rows
end.
```

HW Connection

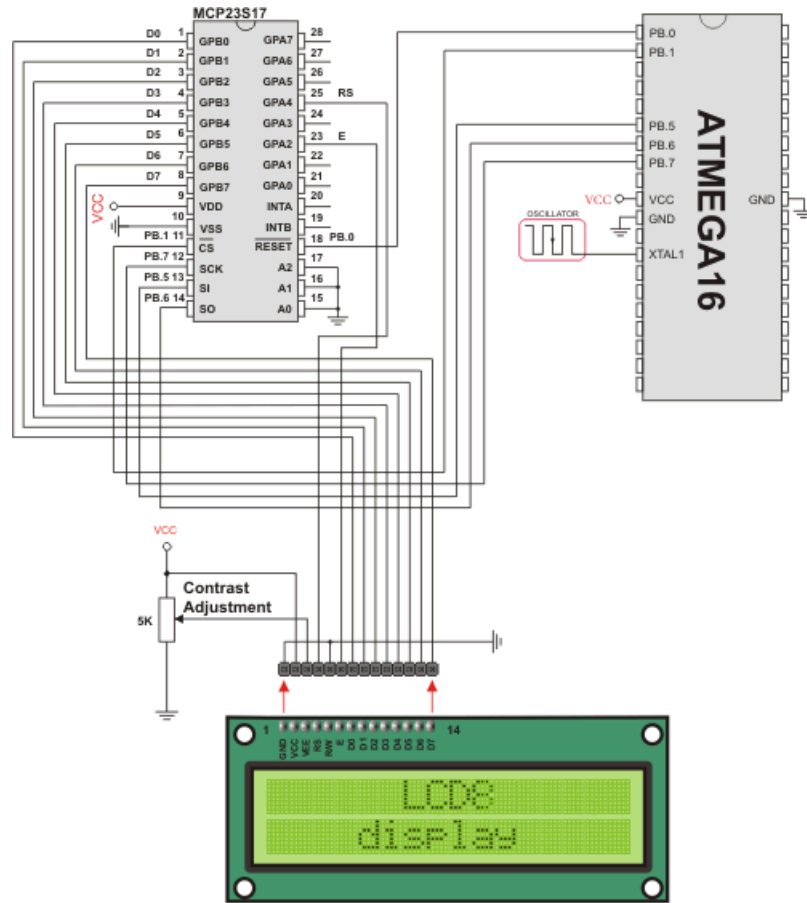

SPI Lcd8 HW connection

SPI T6963C GRAPHIC LCD LIBRARY

The mikroBasic PRO for AVR provides a library for working with Glcds based on TOSHIBA T6963C controller via SPI interface. The Toshiba T6963C is a very popular Lcd controller for the use in small graphics modules. It is capable of controlling displays with a resolution up to 240x128. Because of its low power and small outline it is most suitable for mobile applications such as PDAs, MP3 players or mobile measurement equipment. Although this controller is small, it has a capability of displaying and merging text and graphics and it manages all interfacing signals to the displays Row and Column drivers.

For creating a custom set of Glcd images use Glcd Bitmap Editor Tool.

Note: The library uses the SPI module for communication. The user must initialize SPI module before using the SPI T6963C Glcd Library.

Note: This Library is designed to work with mikroElektronika's Serial Glcd 240x128 and 240x64 Adapter Boards pinout, see schematic at the bottom of this page for details.

Note: Some mikroElektronika's adapter boards have pinout different from T6369C datasheets. Appropriate relations between these labels are given in the table below:

Adapter Board	T6369C datasheet
RS	C/D
R/W	/RD
E	/WR

External dependencies of SPI T6963C Graphic Lcd Library

The implementation of SPI T6963C Graphic Lcd Library routines is based on Port Expander Library routines.

Prior to calling any of this library routines, Spi_Rd_Ptr needs to be initialized with the appropriate SPI_Read routine.

External dependencies are the same as Port Expander Library external dependencies.

Library Routines

- SPI_T6963C_Config
- SPI_T6963C_WriteData
- SPI_T6963C_WriteCommand
- SPI_T6963C_SetPtr
- SPI_T6963C_WaitReady
- SPI_T6963C_Fill
- SPI_T6963C_Dot
- SPI_T6963C_Write_Char
- SPI_T6963C_Write_Text
- SPI_T6963C_Line
- SPI_T6963C_Rectangle
- SPI_T6963C_Box
- SPI_T6963C_Circle
- SPI_T6963C_Image
- SPI_T6963C_Sprite
- SPI_T6963C_Set_Cursor
- SPI_T6963C_ClearBit
- SPI_T6963C_SetBit
- SPI_T6963C_NegBit
- SPI_T6963C_DisplayGrPanel
- SPI_T6963C_DisplayTxtPanel
- SPI_T6963C_SetGrPanel
- SPI_T6963C_SetTxtPanel
- SPI_T6963C_PanelFill
- SPI_T6963C_GrFill
- SPI_T6963C_TxtFill
- SPI_T6963C_Cursor_Height
- SPI_T6963C_Graphics
- SPI_T6963C_Text
- SPI_T6963C_Cursor
- SPI_T6963C_Cursor_Blink

SPI_T6963C_Config

Prototype	<code>sub procedure SPI_T6963C_Config(dim width as word, dim height as word, dim fntW as word, dim DeviceAddress as byte, dim wr as byte, dim rd as byte, dim cd as byte, dim rst as byte)</code>
Returns	Nothing.
Description	<p>Initalizes the Graphic Lcd controller.</p> <p>Parameters :</p> <ul style="list-style-type: none"> - <code>width</code>: width of the Glcd panel - <code>height</code>: height of the Glcd panel - <code>fntW</code>: font width - <code>DeviceAddress</code>: SPI expander hardware address, see schematic at the bottom of this page - <code>wr</code>: write signal pin on Glcd control port - <code>rd</code>: read signal pin on Glcd control port - <code>cd</code>: command/data signal pin on Glcd control port - <code>rst</code>: reset signal pin on Glcd control port <p>Display RAM organization: The library cuts RAM into panels : a complete panel is one graphics panel followed by a text panel (see schematic below).</p> <p>schematic:</p> <pre> +-----+ /\ + GRAPHICS PANEL #0 + + + + + + + +-----+ PANEL 0 + TEXT PANEL #0 + + + \ +-----+ /\ + GRAPHICS PANEL #1 + + + + + +-----+ PANEL 1 + TEXT PANEL #2 + + + +-----+ \ </pre>

Requires	<p>Global variables :</p> <ul style="list-style-type: none"> - <code>SPExpanderCS</code>: Chip Select line - <code>SPExpanderRST</code>: Reset line - <code>SPExpanderCS_Direction</code>: Direction of the Chip Select pin - <code>SPExpanderRST_Direction</code>: Direction of the Reset pin <p>must be defined before using this function.</p> <p>SPI module needs to be initialized. See <code>SPI1_Init</code> and <code>SPI1_Init_Advanced</code> routines.</p>
Example	<pre>// port expander pinout definition dim SPExpanderCS as sbit at PORTB.B1 SPExpanderRST as sbit at PORTB.B0 SPExpanderCS_Direction as sbit at DDRB.B1 SPExpanderRST_Direction as sbit at DDRB.B0 ... ' Initialize SPI module SPI1_Init_Advanced(_SPI_MASTER, _SPI_FCY_DIV32, _SPI_CLK_HI_TRAILING) SPI_Rd_Ptr = @SPI1_Read ' Pass pointer to SPI Read function of used SPI module SPI_T6963C_Config(240, 64, 8, 0, 0, 1, 3, 4)</pre>

SPI_T6963C_WriteData

Prototype	<code>sub procedure SPI_T6963C_WriteData(dim Ddata as byte)</code>
Returns	Nothing.
Description	<p>Writes data to T6963C controller via SPI interface.</p> <p>Parameters :</p> <ul style="list-style-type: none"> - <code>Ddata</code>: data to be written
Requires	Toshiba Glcd module needs to be initialized. See <code>SPI_T6963C_Config</code> routine.
Example	<code>SPI_T6963C_WriteData(AddrL)</code>

SPI_T6963C_WriteCommand

Prototype	<code>sub procedure SPI_T6963C_WriteCommand(dim Ddata as byte)</code>
Returns	Nothing.
Description	Writes command to T6963C controller via SPI interface. Parameters : - <code>Ddata</code> : command to be written
Requires	Toshiba Glcd module needs to be initialized. See SPI_T6963C_Config routine.
Example	<code>SPI_T6963C_WriteCommand(SPI_T6963C_CURSOR_POINTER_SET)</code>

SPI_T6963C_SetPtr

Prototype	<code>sub procedure SPI_T6963C_SetPtr(dim p as word, dim c as byte)</code>
Returns	Nothing.
Description	Sets the memory pointer p for command c. Parameters : - <code>p</code> : address where command should be written - <code>c</code> : command to be written
Requires	SToshiba Glcd module needs to be initialized. See SPI_T6963C_Config routine.
Example	<code>SPI_T6963C_SetPtr(T6963C_grHomeAddr + start, T6963C_ADDRESS_POINTER_SET)</code>

SPI_T6963C_WaitReady

Prototype	<code>sub procedure SPI_T6963C_WaitReady()</code>
Returns	Nothing.
Description	Pools the status byte, and loops until Toshiba Glcd module is ready.
Requires	Toshiba Glcd module needs to be initialized. See SPI_T6963C_Config routine.
Example	<code>SPI_T6963C_WaitReady()</code>

SPI_T6963C_Fill

Prototype	<code>sub procedure SPI_T6963C_Fill(dim v as byte, dim start as word, dim len as word)</code>
Returns	Nothing.
Description	Fills controller memory block with given byte. Parameters : - <code>v</code> : byte to be written - <code>start</code> : starting address of the memory block - <code>len</code> : length of the memory block in bytes
Requires	Toshiba Glcd module needs to be initialized. See SPI_T6963C_Config routine.
Example	<code>SPI_T6963C_Fill(0x33, 0x00FF, 0x000F)</code>

SPI_T6963C_Dot

Prototype	<code>sub procedure SPI_T6963C_Dot(dim x as integer, dim y as integer, dim color as byte)</code>
Returns	Nothing.
Description	Draws a dot in the current graphic panel of Glcd at coordinates (x, y). Parameters : - <code>x</code> : dot position on x-axis - <code>y</code> : dot position on y-axis - <code>color</code> : color parameter. Valid values: SPI_T6963C_BLACK and SPI_T6963C_WHITE
Requires	Toshiba Glcd module needs to be initialized. See SPI_T6963C_Config routine.
Example	<code>SPI_T6963C_Dot(x0, y0, pcolor)</code>

SPI_T6963C_Write_Char

Prototype	<code>sub procedure SPI_T6963C_Write_Char(dim c as byte, dim x as byte, dim y as byte, dim mode as byte)</code>
Returns	Nothing.
Description	<p>Writes a char in the current text panel of Glcd at coordinates (x, y).</p> <p>Parameters :</p> <ul style="list-style-type: none"> - <code>c</code>: char to be written - <code>x</code>: char position on x-axis - <code>y</code>: char position on y-axis - <code>mode</code>: mode parameter. Valid values: SPI_T6963C_ROM_MODE_OR, SPI_T6963C_ROM_MODE_XOR, SPI_T6963C_ROM_MODE_AND and SPI_T6963C_ROM_MODE_TEXT <p>Mode parameter explanation:</p> <ul style="list-style-type: none"> - OR Mode: In the OR-Mode, text and graphics can be displayed and the data is logically "OR-ed". This is the most common way of combining text and graphics for example labels on buttons. - XOR-Mode: In this mode, the text and graphics data are combined via the logical "exclusive OR". This can be useful to display text in negative mode, i.e. white text on black background. - AND-Mode: The text and graphic data shown on display are combined via the logical "AND function". - TEXT-Mode: This option is only available when displaying just a text. The Text Attribute values are stored in the graphic area of display memory. <p>For more details see the T6963C datasheet.</p>
Requires	Toshiba Glcd module needs to be initialized. See SPI_T6963C_Config routine.
Example	<code>SPI_T6963C_Write_Char("A",22,23,AND)</code>

SPI_T6963C_Write_Text

Prototype	<code>sub procedure SPI_T6963C_Write_Text(dim byref str as byte[10] , dim x as byte, dim y as byte, dim mode as byte)</code>
Returns	Nothing.
Description	<p>Writes text in the current text panel of Glcd at coordinates (x, y).</p> <p>Parameters :</p> <ul style="list-style-type: none"> - <code>str</code>: text to be written - <code>x</code>: text position on x-axis - <code>y</code>: text position on y-axis - <code>mode</code>: mode parameter. Valid values: SPI_T6963C_ROM_MODE_OR, SPI_T6963C_ROM_MODE_XOR, SPI_T6963C_ROM_MODE_AND and SPI_T6963C_ROM_MODE_TEXT <p>Mode parameter explanation:</p> <ul style="list-style-type: none"> - OR Mode: In the OR-Mode, text and graphics can be displayed and the data is logically "OR-ed". This is the most common way of combining text and graphics for example labels on buttons. - XOR-Mode: In this mode, the text and graphics data are combined via the logical "exclusive OR". This can be useful to display text in negative mode, i.e. white text on black background. - AND-Mode: The text and graphic data shown on the display are combined via the logical "AND function". - TEXT-Mode: This option is only available when displaying just a text. The Text Attribute values are stored in the graphic area of display memory. <p>For more details see the T6963C datasheet.</p>
Requires	Toshiba Glcd module needs to be initialized. See SPI_T6963C_Config routine.
Example	<code>SPI_T6963C_Write_Text("Glcd LIBRARY DEMO, WELCOME !", 0, 0, T6963C_ROM_MODE_EXOR)</code>

SPI_T6963C_Line

Prototype	<code>sub procedure SPI_T6963C_Line(dim x0 as integer, dim y0 as integer, dim x1 as integer, dim y1 as integer, dim pcolor as byte)</code>
Returns	Nothing.
Description	<p>Draws a line from (x0, y0) to (x1, y1).</p> <p>Parameters :</p> <ul style="list-style-type: none"> - x0: x coordinate of the line start - y0: y coordinate of the line end - x1: x coordinate of the line start - y1: y coordinate of the line end - pcolor: color parameter. Valid values: SPI_T6963C_BLACK and SPI_T6963C_WHITE
Requires	Toshiba Glcd module needs to be initialized. See SPI_T6963C_Config routine.
Example	<code>SPI_T6963C_Line(0, 0, 239, 127, T6963C_WHITE)</code>

SPI_T6963C_Rectangle

Prototype	<code>sub procedure SPI_T6963C_Rectangle(dim x0 as integer, dim y0 as integer, dim x1 as integer, dim y1 as integer, dim pcolor as byte)</code>
Returns	Nothing.
Description	<p>Draws a rectangle on Glcd.</p> <p>Parameters :</p> <ul style="list-style-type: none"> - x0: x coordinate of the upper left rectangle corner - y0: y coordinate of the upper left rectangle corner - x1: x coordinate of the lower right rectangle corner - y1: y coordinate of the lower right rectangle corner - pcolor: color parameter. Valid values: SPI_T6963C_BLACK and SPI_T6963C_WHITE
Requires	Toshiba Glcd module needs to be initialized. See SPI_T6963C_Config routine.
Example	<code>SPI_T6963C_Rectangle(20, 20, 219, 107, T6963C_WHITE)</code>

SPI_T6963C_Box

Prototype	<code>sub procedure SPI_T6963C_Box(dim x0 as integer, dim y0 as integer, dim x1 as integer, dim y1 as integer, dim pcolor as byte)</code>
Returns	Nothing.
Description	Draws a box on the Glcd Parameters : - <code>x0</code> : x coordinate of the upper left box corner - <code>y0</code> : y coordinate of the upper left box corner - <code>x1</code> : x coordinate of the lower right box corner - <code>y1</code> : y coordinate of the lower right box corner - <code>pcolor</code> : color parameter. Valid values: SPI_T6963C_BLACK and SPI_T6963C_WHITE
Requires	Toshiba Glcd module needs to be initialized. See SPI_T6963C_Config routine.
Example	<code>SPI_T6963C_Box(0, 119, 239, 127, T6963C_WHITE)</code>

SPI_T6963C_Circle

Prototype	<code>sub procedure SPI_T6963C_Circle(dim x as integer, dim y as integer, dim r as longint, dim pcolor as byte)</code>
Returns	Nothing.
Description	Draws a circle on the Glcd. Parameters : - <code>x</code> : x coordinate of the circle center - <code>y</code> : y coordinate of the circle center - <code>r</code> : radius size - <code>pcolor</code> : color parameter. Valid values: SPI_T6963C_BLACK and SPI_T6963C_WHITE
Requires	Toshiba Glcd module needs to be initialized. See SPI_T6963C_Config routine.
Example	<code>SPI_T6963C_Circle(120, 64, 110, T6963C_WHITE)</code>

SPI_T6963C_Image

Prototype	<code>sub procedure SPI_T6963C_image(const pic as ^byte)</code>
Returns	Nothing.
Description	<p>Displays bitmap on Glcd.</p> <p>Parameters :</p> <ul style="list-style-type: none"> - <code>pic</code>: image to be displayed. Bitmap array can be located in both code and RAM memory (due to the mikroBasic PRO for AVR pointer to const and pointer to RAM equivalency). <p>Use the mikroBasic PRO's integrated Glcd Bitmap Editor (menu option Tools › Glcd Bitmap Editor) to convert image to a constant array suitable for displaying on Glcd.</p>
Requires	Toshiba Glcd module needs to be initialized. See SPI_T6963C_Config routine.
Example	<code>SPI_T6963C_Image(my_image)</code>

SPI_T6963C_Sprite

Prototype	<code>sub procedure SPI_T6963C_sprite(dim px, py, sx, sy as byte, const pic as ^byte)</code>
Returns	Nothing.
Description	<p>Fills graphic rectangle area (px, py) to (px+sx, py+sy) with custom size picture.</p> <p>Parameters :</p> <ul style="list-style-type: none"> - <code>px</code>: x coordinate of the upper left picture corner. Valid values: multiples of the font width - <code>py</code>: y coordinate of the upper left picture corner - <code>pic</code>: picture to be displayed - <code>sx</code>: picture width. Valid values: multiples of the font width - <code>sy</code>: picture height <p>Note: If <code>px</code> and <code>sx</code> parameters are not multiples of the font width they will be scaled to the nearest lower number that is a multiple of the font width.</p>
Requires	Toshiba Glcd module needs to be initialized. See SPI_T6963C_Config routine.
Example	<code>SPI_T6963C_Sprite(76, 4, einstein, 88, 119) ' draw a sprite</code>

SPI_T6963C_Set_Cursor

Prototype	<code>sub procedure SPI_T6963C_set_cursor(dim x, y as byte)</code>
Returns	Nothing.
Description	Sets cursor to row x and column y. Parameters : - x: cursor position row number - y: cursor position column number
Requires	Toshiba Glcd module needs to be initialized. See SPI_T6963C_Config routine.
Example	<code>SPI_T6963C_Set_Cursor(cposx, cposy)</code>

SPI_T6963C_ClearBit

Prototype	<code>sub procedure SPI_T6963C_clearBit(dim b as byte)</code>
Returns	Nothing.
Description	Clears control port bit(s). Parameters : - b: bit mask. The function will clear bit x on control port if bit x in bit mask is set to 1.
Requires	Toshiba Glcd module needs to be initialized. See SPI_T6963C_Config routine.
Example	<code>' clear bits 0 and 1 on control port SPI_T6963C_ClearBit(0x03)</code>

SPI_T6963C_SetBit

Prototype	<code>sub procedure SPI_T6963C_setBit(dim b as byte)</code>
Returns	Nothing.
Description	Sets control port bit(s). Parameters : - b: bit mask. The function will set bit x on control port if bit x in bit mask is set to 1.
Requires	Toshiba Glcd module needs to be initialized. See SPI_T6963C_Config routine.
Example	<code>' set bits 0 and 1 on control port SPI_T6963C_SetBit(0x03)</code>

SPI_T6963C_NegBit

Prototype	<code>sub procedure SPI_T6963C_negBit(dim b as byte)</code>
Returns	Nothing.
Description	<p>Negates control port bit(s).</p> <p>Parameters :</p> <p>- b: bit mask. The function will negate bit x on control port if bit x in bit mask is set to 1.</p>
Requires	Toshiba Glcd module needs to be initialized. See SPI_T6963C_Config routine.
Example	<pre>' negate bits 0 and 1 on control port SPI_T6963C_NegBit(0x03)</pre>

SPI_T6963C_DisplayGrPanel

Prototype	<code>sub procedure SPI_T6963C_DisplayGrPanel(dim n as byte)</code>
Returns	Nothing.
Description	<p>Display selected graphic panel.</p> <p>Parameters :</p> <p>- n: graphic panel number. Valid values: 0 and 1.</p>
Requires	Toshiba Glcd module needs to be initialized. See SPI_T6963C_Config routine.
Example	<pre>' display graphic panel 1 SPI_T6963C_DisplayGrPanel(1)</pre>

SPI_T6963C_DisplayTxtPanel

Prototype	<code>sub procedure SPI_T6963C_DisplayTxtPanel(dim n as byte)</code>
Returns	Nothing.
Description	<p>Display selected text panel.</p> <p>Parameters :</p> <p>- n: text panel number. Valid values: 0 and 1.</p>
Requires	Toshiba Glcd module needs to be initialized. See SPI_T6963C_Config routine.
Example	<pre>' display text panel 1 SPI_T6963C_DisplayTxtPanel(1)</pre>

SPI_T6963C_SetGrPanel

Prototype	<code>sub procedure SPI_T6963C_SetGrPanel(dim n as byte)</code>
Returns	Nothing.
Description	<p>Compute start address for selected graphic panel and set appropriate internal pointers. All subsequent graphic operations will be preformed at this graphic panel.</p> <p>Parameters :</p> <p>- <i>n</i>: graphic panel number. Valid values: 0 and 1.</p>
Requires	Toshiba Glcd module needs to be initialized. See SPI_T6963C_Config routine.
Example	<pre>' set graphic panel 1 as current graphic panel. SPI_T6963C_SetGrPanel(1)</pre>

SPI_T6963C_SetTxtPanel

Prototype	<code>sub procedure SPI_T6963C_SetTxtPanel(dim n as byte)</code>
Returns	Nothing.
Description	<p>Compute start address for selected text panel and set appropriate internal pointers. All subsequent text operations will be preformed at this text panel.</p> <p>Parameters :</p> <p>- <i>n</i>: text panel number. Valid values: 0 and 1.</p>
Requires	Toshiba Glcd module needs to be initialized. See SPI_T6963C_Config routine.
Example	<pre>' set text panel 1 as current text panel. SPI_T6963C_SetTxtPanel(1)</pre>

SPI_T6963C_PanelFill

Prototype	<code>sub procedure SPI_T6963C_PanelFill(dim v as byte)</code>
Returns	Nothing.
Description	Fill current panel in full (graphic+text) with appropriate value (0 to clear). Parameters : - v : value to fill panel with.
Requires	Toshiba Glcd module needs to be initialized. See SPI_T6963C_Config routine.
Example	<pre>clear current panel SPI_T6963C_PanelFill(0)</pre>

SPI_T6963C_GrFill

Prototype	<code>sub procedure SPI_T6963C_GrFill(dim v as byte)</code>
Returns	Nothing.
Description	Fill current graphic panel with appropriate value (0 to clear). Parameters : - v : value to fill graphic panel with.
Requires	Toshiba Glcd module needs to be initialized. See SPI_T6963C_Config routine.
Example	<pre>' clear current graphic panel SPI_T6963C_GrFill(0)</pre>

SPI_T6963C_TxtFill

Prototype	<code>sub procedure SPI_T6963C_TxtFill(dim v as byte)</code>
Returns	Nothing.
Description	Fill current text panel with appropriate value (0 to clear). Parameters : - v : this value increased by 32 will be used to fill text panel.
Requires	Toshiba Glcd module needs to be initialized. See SPI_T6963C_Config routine.
Example	<pre>' clear current text panel SPI_T6963C_TxtFill(0)</pre>

SPI_T6963C_Cursor_Height

Prototype	<code>sub procedure SPI_T6963C_Cursor_Height (dim n as byte)</code>
Returns	Nothing.
Description	Set cursor size. Parameters : - <i>n</i> : cursor height. Valid values: 0..7.
Requires	Toshiba Glcd module needs to be initialized. See SPI_T6963C_Config routine.
Example	<code>SPI_T6963C_Cursor_Height(7)</code>

SPI_T6963C_Graphics

Prototype	<code>sub procedure SPI_T6963C_Graphics (dim n as byte)</code>
Returns	Nothing.
Description	Enable/disable graphic displaying. Parameters : - <i>n</i> : graphic enable/disable parameter. Valid values: 0 (disable graphic displaying) and 1 (enable graphic displaying).
Requires	Toshiba Glcd module needs to be initialized. See SPI_T6963C_Config routine.
Example	<code>' enable graphic displaying SPI_T6963C_Graphics(1)</code>

SPI_T6963C_Text

Prototype	<code>sub procedure SPI_T6963C_Text (dim n as byte)</code>
Returns	Nothing.
Description	Enable/disable text displaying. Parameters : - <i>n</i> : text enable/disable parameter. Valid values: 0 (disable text displaying) and 1 (enable text displaying).
Requires	Toshiba Glcd module needs to be initialized. See SPI_T6963C_Config routine.
Example	<code>' enable text displaying SPI_T6963C_Text(1)</code>

SPI_T6963C_Cursor

Prototype	<code>sub procedure SPI_T6963C_Cursor(dim n as byte)</code>
Returns	Nothing.3q
Description	Set cursor on/off. Parameters : - n : on/off parameter. Valid values: 0 (set cursor off) and 1 (set cursor on).
Requires	Toshiba Glcd module needs to be initialized. See SPI_T6963C_Config routine.
Example	<pre>' set cursor on SPI_T6963C_Cursor(1)</pre>

SPI_T6963C_Cursor_Blink

Prototype	<code>sub procedure SPI_T6963C_Cursor_Blink(dim n as byte)</code>
Returns	Nothing.
Description	Enable/disable cursor blinking. Parameters : - n : cursor blinking enable/disable parameter. Valid values: 0 (disable cursor blinking) and 1 (enable cursor blinking).
Requires	Toshiba Glcd module needs to be initialized. See SPI_T6963C_Config routine.
Example	<pre>' enable cursor blinking SPI_T6963C_Cursor_Blink(1)</pre>

Library Example

The following drawing demo tests advanced routines of the SPI T6963C Glcd library. Hardware configurations in this example are made for the T6963C 240x128 display, EasyAVR5A board and ATmega16.

```

program SPI_T6963C_240x128

include __Lib_SPI_T6963C_Const
include bitmap
include bitmap2

dim
' Port Expander module connections
  SPExpanderRST as sbit at PORTB.B0
  SPExpanderCS  as sbit at PORTB.B1
  SPExpanderRST_Direction as sbit at DDRB.B0
  SPExpanderCS_Direction as sbit at DDRB.B1
' End Port Expander module connections

dim  panel as byte           ' current panel
      i as word             ' general purpose register
      curs as byte         ' cursor visibility
      cposx,
      cposy as word        ' cursor x-y position
      txt, txt1 as string[ 29]

      txt1 = " EINSTEIN WOULD HAVE LIKED ME"
      txt  = " GLCD LIBRARY DEMO, WELCOME !"

      DDRA = 0x00                ' configure PORTA as input

' *
' *  init display for 240 pixel width and 128 pixel height
' *  8 bits character width
' *  data bus on MCP23S17 portB
' *  control bus on MCP23S17 portA
' *  bit 2 is !WR
' *  bit 1 is !RD
' *  bit 0 is !CD
' *  bit 4 is RST
' *  chip enable, reverse on, 8x8 font internally set in library
' *

' Pass pointer to SPI Read function of used SPI module
Spi_Rd_Ptr = @SPI1_Read

' Initialize SPI module
SPI1_Init_Advanced(_SPI_MASTER, _SPI_FCY_DIV2, _SPI_CLK_HI_TRAILING)

```

```

' ' If Port Expander Library uses SPI2 module
' Pass pointer to SPI Read function of used SPI module
' Spi_Rd_Ptr = @SPI2_Read          ' Pass pointer to SPI Read
function of used SPI module

' Initialize SPI module used with PortExpander
' SPI2_Init_Advanced(_SPI_MASTER, _SPI_FCY_DIV2,
_SPI_CLK_HI_TRAILING)

' Initialize SPI Toshiba 240x128
SPI_T6963C_Config(240, 128, 8, 0, 2, 1, 0, 4)
'Delay_ms(1000)

' *
' * Enable both graphics and text display at the same time
' *

SPI_T6963C_graphics(1)

SPI_T6963C_text(1)

panel = 0
i = 0
curs = 0
cposx = 0
cposy = 0

' *
' * Text messages
' *

SPI_T6963C_write_text(txt, 0, 0, SPI_T6963C_ROM_MODE_XOR)
SPI_T6963C_write_text(txt1, 0, 15, SPI_T6963C_ROM_MODE_XOR)

'*
'* Cursor
'*

SPI_T6963C_cursor_height(8)          ' 8 pixel height
SPI_T6963C_set_cursor(0, 0)         ' move cursor to top left
SPI_T6963C_cursor(0)                ' cursor off

'*
'* Draw rectangles
'*
SPI_T6963C_rectangle(0, 0, 239, 127, SPI_T6963C_WHITE)
SPI_T6963C_rectangle(20, 20, 219, 107, SPI_T6963C_WHITE)
SPI_T6963C_rectangle(40, 40, 199, 87, SPI_T6963C_WHITE)
SPI_T6963C_rectangle(60, 60, 179, 67, SPI_T6963C_WHITE)

```



```

    '*
    '* Draw a cross
    '*
    SPI_T6963C_line(0, 0, 239, 127, SPI_T6963C_WHITE)
    SPI_T6963C_line(0, 127, 239, 0, SPI_T6963C_WHITE)

    '*
    '* Draw solid boxes
    '*
    SPI_T6963C_box(0, 0, 239, 8, SPI_T6963C_WHITE)
    SPI_T6963C_box(0, 119, 239, 127, SPI_T6963C_WHITE)

    '*
    '* Draw circles
    '*
    SPI_T6963C_circle(120, 64, 10, SPI_T6963C_WHITE)
    SPI_T6963C_circle(120, 64, 30, SPI_T6963C_WHITE)
    SPI_T6963C_circle(120, 64, 50, SPI_T6963C_WHITE)
    SPI_T6963C_circle(120, 64, 70, SPI_T6963C_WHITE)
    SPI_T6963C_circle(120, 64, 90, SPI_T6963C_WHITE)
    SPI_T6963C_circle(120, 64, 110, SPI_T6963C_WHITE)
    SPI_T6963C_circle(120, 64, 130, SPI_T6963C_WHITE)

    SPI_T6963C_sprite(76, 4, @einstein, 88, 119)      ' Draw a sprite
    SPI_T6963C_setGrPanel(1)                          ' Select other
    graphic panel                                     '
    SPI_T6963C_image(@mikroe)                          ' Fill the
    graphic screen with a picture

    while TRUE                                         ' Endless loop

    '*
    '* If PORTA_0 is pressed, toggle the display between graphic
    panel 0 and graphic 1
    '*
    if( PINA0_bit = 0) then
        Inc(panel)
        panel = panel and 1
        SPI_T6963C_setPtr((SPI_T6963C_grMemSize +
    SPI_T6963C_txtMemSize) * panel, SPI_T6963C_GRAPHIC_HOME_ADDRESS_SET)
        Delay_ms(300)

    '*
    '* If PORTA_1 is pressed, display only graphic panel
    '*
    else
        if ( PINA1_bit = 0) then
            SPI_T6963C_graphics(1)
            SPI_T6963C_text(0)
            Delay_ms(300)

```

```

    '*
    '* If PORTA_3 is pressed, display text and graphic panels
    '*
        else
            if ( PINA3_bit = 0) then
                SPI_T6963C_graphics(1)
                SPI_T6963C_text(1)
                Delay_ms(300)

    '*
    '* If PORTA_4 is pressed, change cursor
    '*
        else
            if( PINA4_bit = 0) then
                Inc(curs)
                if (curs = 3) then
                    curs = 0
                end if
                select case curs
                    case 0
                        ' no cursor
                        SPI_T6963C_cursor(0)

                    case 1
                        ' blinking cursor
                        SPI_T6963C_cursor(1)
                        SPI_T6963C_cursor_blink(1)
                    case 2
                        ' non blinking cursor
                        SPI_T6963C_cursor(1)
                        SPI_T6963C_cursor_blink(0)
                end select
                Delay_ms(300)
            end if
        end if
    end if
end if

    '*
    '* Move cursor, even if not visible
    '*
    Inc(cposx)
    if (cpox = SPI_T6963C_txtCols) then
        cposx = 0
        Inc(cposy)
        if (cpoxy = SPI_T6963C_grHeight / SPI_T6963C_CHARACTER_HEIGHT)
then
            cposy = 0
        end if
    end if
    SPI_T6963C_set_cursor(cposx, cposy)

    Delay_ms(100)
wend
end.
```

HW Connection

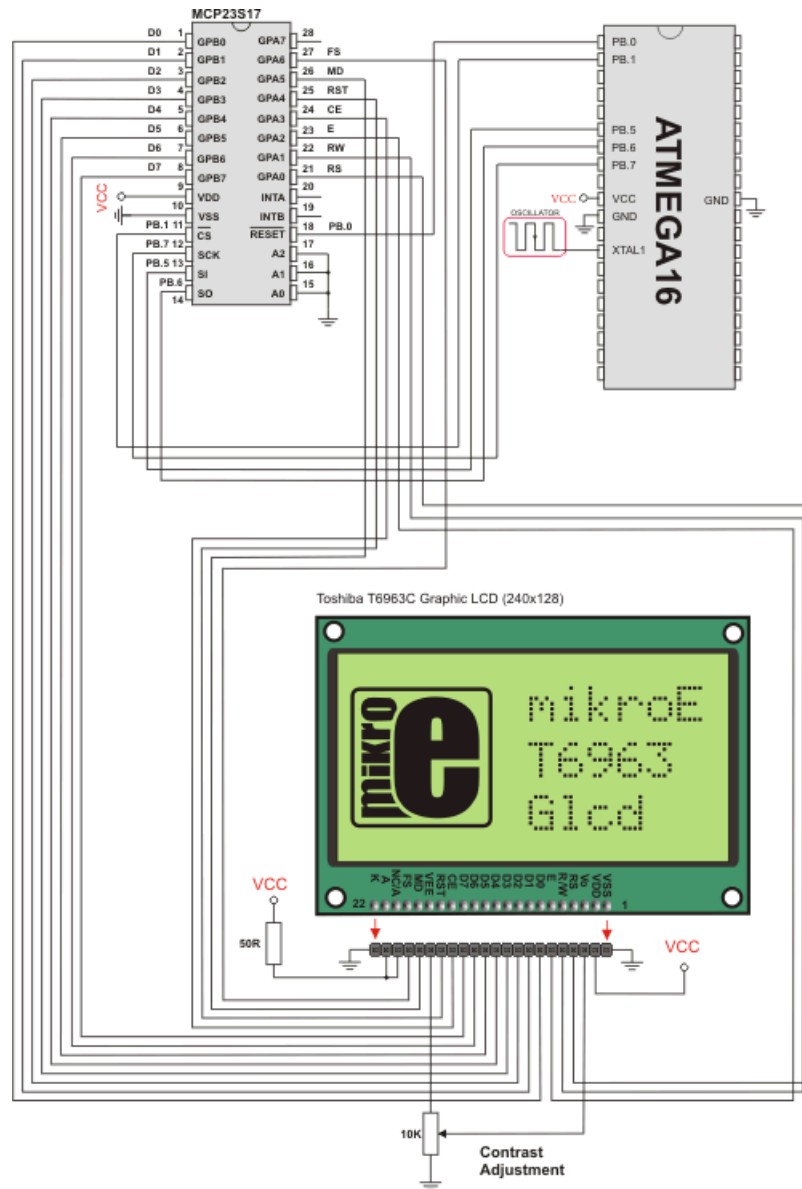

SPI T6963C Glcd HW connection

SPI T6963C GRAPHIC LCD LIBRARY

The mikroBasic PRO for AVR provides a library for working with Glcds based on TOSHIBA T6963C controller. The Toshiba T6963C is a very popular Lcd controller for the use in small graphics modules. It is capable of controlling displays with a resolution up to 240x128. Because of its low power and small outline it is most suitable for mobile applications such as PDAs, MP3 players or mobile measurement equipment. Although small, this controller has a capability of displaying and merging text and graphics and it manages all the interfacing signals to the displays Row and Column drivers.

For creating a custom set of Glcd images use Glcd Bitmap Editor Tool.

Note: ChipEnable(CE), FontSelect(FS) and Reverse(MD) have to be set to appropriate levels by the user outside of the T6963C_Init function. See the Library Example code at the bottom of this page.

Note: Some mikroElektronika's adapter boards have pinout different from T6369C datasheets. Appropriate relations between these labels are given in the table below:

Adapter Board	T6369C datasheet
RS	C/D
R/W	/RD
E	/WR

External dependencies of T6963C Graphic Lcd Library

The following variables must be defined in all projects using T6963C Graphic Lcd library:	Description:	Example :
<code>dim T6963C_dataPort as byte sfr external</code>	T6963C Data Port.	<code>dim T6963C_dataPort as byte at PORTD</code>
<code>dim T6963C_ctrlPort as byte sfr external</code>	T6963C Control Port.	<code>dim T6963C_ctrlPort as byte at PORTC</code>
<code>dim T6963C_ctrlwr as sbit sfr external</code>	Write signal.	<code>dim T6963C_ctrlwr as sbit at PORTC.B2</code>
<code>dim T6963C_ctrlrd as sbit sfr external</code>	Read signal.	<code>dim T6963C_ctrlrd as sbit at PORTC.B1</code>
<code>dim T6963C_ctrlcd as sbit sfr external</code>	Command/Data signal.	<code>dim T6963C_ctrlcd as sbit at PORTC.B0</code>
<code>dim T6963C_ctrlrst as sbit sfr external</code>	Reset signal.	<code>dim T6963C_ctrlrst as sbit at PORTC.B4</code>
<code>dim T6963C_dataPort_Direction as byte sfr external</code>	Direction of the T6963C Data Port.	<code>dim T6963C_dataPort_Direction as byte at DDRD</code>
<code>dim T6963C_ctrlPort_Direction as byte sfr external</code>	Direction of the T6963C Control Port.	<code>dim T6963C_ctrlPort_Direction as byte at DDRC</code>
<code>dim T6963C_ctrlwr_Direction as sbit sfr external</code>	Direction of the Write pin.	<code>dim T6963C_ctrlwr_Direction as sbit at DDRC.B2</code>
<code>dim T6963C_ctrlrd_Direction as sbit sfr external</code>	Direction of the Read pin.	<code>dim T6963C_ctrlrd_Direction as sbit at DDRC.B1</code>
<code>dim T6963C_ctrlcd_Direction as sbit sfr external</code>	Direction of the Command/Data pin.	<code>dim T6963C_ctrlcd_Direction as sbit at DDRC.B0</code>
<code>dim T6963C_ctrlrst_Direction as sbit sfr external</code>	Direction of the Reset pin.	<code>dim T6963C_ctrlrst_Direction as sbit at DDRC.B4</code>

Library Routines

- T6963C_Init
- T6963C_WriteData
- T6963C_WriteCommand
- T6963C_SetPtr
- T6963C_WaitReady
- T6963C_Fill
- T6963C_Dot
- T6963C_Write_Char
- T6963C_Write_Text
- T6963C_Line
- T6963C_Rectangle
- T6963C_Box
- T6963C_Circle
- T6963C_Image
- T6963C_Sprite
- T6963C_Set_Cursor
- T6963C_DisplayGrPanel
- T6963C_DisplayTxtPanel
- T6963C_SetGrPanel
- T6963C_SetTxtPanel
- T6963C_PanelFill
- T6963C_GrFill
- T6963C_TxtFill
- T6963C_Cursor_Height
- T6963C_Graphics
- T6963C_Text
- T6963C_Cursor
- T6963C_Cursor_Blink

T6963C_Init

Prototype	<code>sub procedure T6963C_init(dim width, height, fntW as byte)</code>
Returns	Nothing.
Description	<p>Initializes the Graphic Lcd controller.</p> <p>Parameters :</p> <ul style="list-style-type: none"> - <code>width</code>: width of the Glcd panel - <code>height</code>: height of the Glcd panel - <code>fntW</code>: font width <p>Display RAM organization: The library cuts the RAM into panels : a complete panel is one graphics panel followed by a text panel (see schematic below).</p> <p>schematic:</p> <pre> +-----+ ^\ + GRAPHICS PANEL #0 + + + + + + + +-----+ PANEL 0 + TEXT PANEL #0 + + + \/\ +-----+ ^\ + GRAPHICS PANEL #1 + + + + + + + +-----+ PANEL 1 + TEXT PANEL #2 + + + +-----+ \/\ </pre>
Requires	<p>Global variables :</p> <ul style="list-style-type: none"> - <code>T6963C_dataPort</code>: Data Port - <code>T6963C_ctrlPort</code>: Control Port - <code>T6963C_ctrlwr</code>: Write signal pin - <code>T6963C_ctrlrd</code>: Read signal pin - <code>T6963C_ctrlcd</code>: Command/Data signal pin - <code>T6963C_ctrlrst</code>: Reset signal pin - <code>T6963C_dataPort_Direction</code>: Direction of Data Port - <code>T6963C_ctrlPort_Direction</code>: Direction of Control Port - <code>T6963C_ctrlwr_Direction</code>: Direction of Write signal pin - <code>T6963C_ctrlrd_Direction</code>: Direction of Read signal pin - <code>T6963C_ctrlcd_Direction</code>: Direction of Command/Data signal pin - <code>T6963C_ctrlrst_Direction</code>: Direction of Reset signal pin <p>must be defined before using this function.</p>

Example	<pre>' T6963C module connections dim T6963C_ctrlPort as byte at PORTC dim T6963C_dataPort as byte at PORTD dim T6963C_ctrlPort_Direction as byte at DDRD dim T6963C_dataPort_Direction as byte at DDRC dim T6963C_ctrlwr as sbit at PORTC.B2 dim T6963C_ctrlrd as sbit at PORTC.B1 dim T6963C_ctrlcd as sbit at PORTC.B0 dim T6963C_ctrlrst as sbit at PORTC.B4 dim T6963C_ctrlwr_Direction as sbit at DDRC.B2 dim T6963C_ctrlrd_Direction as sbit at DDRC.B1 dim T6963C_ctrlcd_Direction as sbit at DDRC.B0 dim T6963C_ctrlrst_Direction as sbit at DDRC.B4 ' End of T6963C module connections ... ' init display for 240 pixel width, 128 pixel height and 8 bits character width T6963C_init(240, 128, 8)</pre>
----------------	--

T6963C_WriteData

Prototype	<code>sub procedure T6963C_WriteData(dim mydata as byte)</code>
Returns	Nothing.
Description	Writes data to T6963C controller. Parameters : - <code>mydata</code> : data to be written
Requires	Toshiba Glcd module needs to be initialized. See the T6963C_Init routine.
Example	<code>T6963C_WriteData(AddrL)</code>

T6963C_WriteCommand

Prototype	<code>sub procedure T6963C_WriteCommand(dim mydata as byte)</code>
Returns	Nothing.
Description	Writes command to T6963C controller. Parameters : - <code>mydata</code> : command to be written
Requires	Toshiba Glcd module needs to be initialized. See the T6963C_Init routine.
Example	<code>T6963C_WriteCommand(T6963C_CURSOR_POINTER_SET)</code>

T6963C_SetPtr

Prototype	<code>sub procedure T6963C_SetPtr(dim p as word, dim c as byte)</code>
Returns	Nothing.
Description	Sets the memory pointer p for command c. Parameters : - <code>p</code> : address where command should be written - <code>c</code> : command to be written
Requires	Toshiba Glcd module needs to be initialized. See the T6963C_Init routine.
Example	<code>T6963C_SetPtr(T6963C_grHomeAddr + start, T6963C_ADDRESS_POINTER_SET)</code>

T6963C_WaitReady

Prototype	<code>sub procedure T6963C_WaitReady()</code>
Returns	Nothing.
Description	Pools the status byte, and loops until Toshiba Glcd module is ready.
Requires	Toshiba Glcd module needs to be initialized. See the T6963C_Init routine.
Example	<code>T6963C_WaitReady()</code>

T6963C_Fill

Prototype	<code>sub procedure T6963C_Fill(dim v as byte, dim start, len as word)</code>
Returns	Nothing.
Description	<p>Fills controller memory block with given byte.</p> <p>Parameters :</p> <ul style="list-style-type: none"> - <code>v</code>: byte to be written - <code>start</code>: starting address of the memory block - <code>len</code>: length of the memory block in bytes
Requires	Toshiba Glcd module needs to be initialized. See the T6963C_Init routine.
Example	<code>T6963C_Fill(0x33,0x00FF,0x000F)</code>

T6963C_Dot

Prototype	<code>sub procedure T6963C_Dot(dim x, y as integer, dim color as byte)</code>
Returns	Nothing.
Description	<p>Draws a dot in the current graphic panel of Glcd at coordinates (x, y).</p> <p>Parameters :</p> <ul style="list-style-type: none"> - <code>x</code>: dot position on x-axis - <code>y</code>: dot position on y-axis - <code>color</code>: color parameter. Valid values: T6963C_BLACK and T6963C_WHITE
Requires	Toshiba Glcd module needs to be initialized. See the T6963C_Init routine.
Example	<code>T6963C_Dot(x0, y0, pcolor)</code>

T6963C_Write_Char

Prototype	<code>sub procedure T6963C_Write_Char(dim c, x, y, mode as byte)</code>
Returns	Nothing.
Description	<p>Writes a char in the current text panel of Glcd at coordinates (x, y).</p> <p>Parameters :</p> <ul style="list-style-type: none"> - <code>c</code>: char to be written - <code>x</code>: char position on x-axis - <code>y</code>: char position on y-axis - <code>mode</code>: mode parameter. Valid values: T6963C_ROM_MODE_OR, T6963C_ROM_MODE_XOR, T6963C_ROM_MODE_AND and T6963C_ROM_MODE_TEXT <p>Mode parameter explanation:</p> <ul style="list-style-type: none"> - OR Mode: In the OR-Mode, text and graphics can be displayed and the data is logically “OR-ed”. This is the most common way of combining text and graphics for example labels on buttons. - XOR-Mode: In this mode, the text and graphics data are combined via the logical “exclusive OR”. This can be useful to display text in the negative mode, i.e. white text on black background. - AND-Mode: The text and graphic data shown on display are combined via the logical “AND function”. - TEXT-Mode: This option is only available when displaying just a text. The Text Attribute values are stored in the graphic area of display memory. <p>For more details see the T6963C datasheet.</p>
Requires	Toshiba Glcd module needs to be initialized. See the T6963C_Init routine.
Example	<code>T6963C_Write_Char('A', 22, 23, AND)</code>

T6963C_Write_Text

Prototype	<code>sub procedure T6963C_Write_Text(dim byref str as byte[10], dim x, y, mode as byte)</code>
Returns	Nothing.
Description	<p>Writes text in the current text panel of Glcd at coordinates (x, y).</p> <p>Parameters :</p> <ul style="list-style-type: none"> - <code>str</code>: text to be written - <code>x</code>: text position on x-axis - <code>y</code>: text position on y-axis - <code>mode</code>: mode parameter. Valid values: T6963C_ROM_MODE_OR, T6963C_ROM_MODE_XOR, T6963C_ROM_MODE_AND and T6963C_ROM_MODE_TEXT <p>Mode parameter explanation:</p> <ul style="list-style-type: none"> - OR Mode: In the OR-Mode, text and graphics can be displayed and the data is logically “OR-ed”. This is the most common way of combining text and graphics for example labels on buttons. - XOR-Mode: In this mode, the text and graphics data are combined via the logical “exclusive OR”. This can be useful to display text in the negative mode, i.e. white text on black background. - AND-Mode: The text and graphic data shown on display are combined via the logical “AND function”. - TEXT-Mode: This option is only available when displaying just a text. The Text Attribute values are stored in the graphic area of display memory. <p>For more details see the T6963C datasheet.</p>
Requires	Toshiba Glcd module needs to be initialized. See the T6963C_Init routine.
Example	<code>T6963C_Write_Text(" GLCD LIBRARY DEMO, WELCOME !", 0, 0, T6963C_ROM_MODE_XOR)</code>

T6963C_Line

Prototype	<code>sub procedure T6963C_Line(dim x0, y0, x1, y1 as integer, dim pcolor as byte)</code>
Returns	Nothing.
Description	<p>Draws a line from (x0, y0) to (x1, y1).</p> <p>Parameters :</p> <ul style="list-style-type: none"> - x0: x coordinate of the line start - y0: y coordinate of the line end - x1: x coordinate of the line start - y1: y coordinate of the line end - pcolor: color parameter. Valid values: T6963C_BLACK and T6963C_WHITE
Requires	Toshiba Glcd module needs to be initialized. See the T6963C_Init routine.
Example	<code>T6963C_Line(0, 0, 239, 127, T6963C_WHITE)</code>

T6963C_Rectangle

Prototype	<code>sub procedure T6963C_Rectangle(dim x0, y0, x1, y1 as integer, dim pcolor as byte)</code>
Returns	Nothing.
Description	<p>Draws a rectangle on Glcd.</p> <p>Parameters :</p> <ul style="list-style-type: none"> - x0: x coordinate of the upper left rectangle corner - y0: y coordinate of the upper left rectangle corner - x1: x coordinate of the lower right rectangle corner - y1: y coordinate of the lower right rectangle corner - pcolor: color parameter. Valid values: T6963C_BLACK and T6963C_WHITE
Requires	Toshiba Glcd module needs to be initialized. See the T6963C_Init routine.
Example	<code>T6963C_Rectangle(20, 20, 219, 107, T6963C_WHITE)</code>

T6963C_Box

Prototype	<code>sub procedure T6963C_Box(dim x0, y0, x1, y1 as integer, dim pcolor as byte)</code>
Returns	Nothing.
Description	<p>Draws a box on Glcd</p> <p>Parameters :</p> <ul style="list-style-type: none"> - <code>x0</code>: x coordinate of the upper left box corner - <code>y0</code>: y coordinate of the upper left box corner - <code>x1</code>: x coordinate of the lower right box corner - <code>y1</code>: y coordinate of the lower right box corner - <code>pcolor</code>: color parameter. Valid values: T6963C_BLACK and T6963C_WHITE
Requires	Toshiba Glcd module needs to be initialized. See the T6963C_Init routine.
Example	<code>T6963C_Box(0, 119, 239, 127, T6963C_WHITE)</code>

T6963C_Circle

Prototype	<code>sub procedure T6963C_Circle(dim x, y as integer, dim r as longint, dim pcolor as byte)</code>
Returns	Nothing.
Description	<p>Draws a circle on Glcd.</p> <p>Parameters :</p> <ul style="list-style-type: none"> - <code>x</code>: x coordinate of the circle center - <code>y</code>: y coordinate of the circle center - <code>r</code>: radius size - <code>pcolor</code>: color parameter. Valid values: T6963C_BLACK and T6963C_WHITE
Requires	Toshiba Glcd module needs to be initialized. See the T6963C_Init routine.
Example	<code>T6963C_Circle(120, 64, 110, T6963C_WHITE)</code>

T6963C_Image

Prototype	<code>sub procedure T6963C_Image(const pic as ^byte)</code>
Returns	Nothing.
Description	<p>Displays bitmap on Glcd.</p> <p>Parameters :</p> <ul style="list-style-type: none"> - <code>pic</code>: image to be displayed. Bitmap array can be located in both code and RAM memory (due to the mikroBasic PRO for AVR pointer to const and pointer to RAM equivalency). <p>Use the mikroBasic PRO's integrated Glcd Bitmap Editor (menu option Tools › Glcd Bitmap Editor) to convert image to a constant array suitable for displaying on Glcd.</p>
Requires	Toshiba Glcd module needs to be initialized. See the T6963C_Init routine.
Example	<code>T6963C_Image(mc)</code>

T6963C_Sprite

Prototype	<code>sub procedure T6963C_Sprite(dim px, py, sx, sy as byte, const pic as ^byte)</code>
Returns	Nothing.
Description	<p>Fills graphic rectangle area (px, py) to (px+sx, py+sy) with custom size picture.</p> <p>Parameters :</p> <ul style="list-style-type: none"> - <code>px</code>: x coordinate of the upper left picture corner. Valid values: multiples of the font width - <code>py</code>: y coordinate of the upper left picture corner - <code>pic</code>: picture to be displayed - <code>sx</code>: picture width. Valid values: multiples of the font width - <code>sy</code>: picture height <p>Note: If <code>px</code> and <code>sx</code> parameters are not multiples of the font width they will be scaled to the nearest lower number that is a multiple of the font width.</p>
Requires	Toshiba Glcd module needs to be initialized. See the T6963C_Init routine.
Example	<code>T6963C_Sprite(76, 4, einstein, 88, 119) ' draw a sprite</code>

T6963C_Set_Cursor

Prototype	<code>sub procedure T6963C_Set_Cursor(dim x, y as byte)</code>
Returns	Nothing.
Description	Sets cursor to row x and column y. Parameters : - x: cursor position row number - y: cursor position column number
Requires	Toshiba Glcd module needs to be initialized. See the T6963C_Init routine.
Example	<code>T6963C_Set_Cursor(cposx, cposy)</code>

T6963C_DisplayGrPanel

Prototype	<code>sub procedure T6963C_DisplayGrPanel(dim n as byte)</code>
Returns	Nothing.
Description	Display selected graphic panel. Parameters : - n: graphic panel number. Valid values: 0 and 1.
Requires	Toshiba Glcd module needs to be initialized. See the T6963C_Init routine.
Example	<code>' display graphic panel 1 T6963C_DisplayGrPanel(1)</code>

T6963C_DisplayTxtPanel

Prototype	<code>sub procedure T6963C_DisplayTxtPanel(dim n as byte)</code>
Returns	Nothing.
Description	Display selected text panel. Parameters : - n: text panel number. Valid values: 0 and 1.
Requires	Toshiba Glcd module needs to be initialized. See the T6963C_Init routine.
Example	<code>' display text panel 1 T6963C_DisplayTxtPanel(1)</code>

T6963C_SetGrPanel

Prototype	<code>sub procedure T6963C_SetGrPanel(dim n as byte)</code>
Returns	Nothing.
Description	<p>Compute start address for selected graphic panel and set appropriate internal pointers. All subsequent graphic operations will be preformed at this graphic panel.</p> <p>Parameters :</p> <p>- <code>n</code>: graphic panel number. Valid values: 0 and 1.</p>
Requires	Toshiba Glcd module needs to be initialized. See the T6963C_Init routine.
Example	<pre>' set graphic panel 1 as current graphic panel. T6963C_SetGrPanel(1)</pre>

T6963C_SetTxtPanel

Prototype	<code>sub procedure T6963C_SetTxtPanel(dim n as byte)</code>
Returns	Nothing.
Description	<p>Compute start address for selected text panel and set appropriate internal pointers. All subsequent text operations will be preformed at this text panel.</p> <p>Parameters :</p> <p>- <code>n</code>: text panel number. Valid values: 0 and 1.</p>
Requires	Toshiba Glcd module needs to be initialized. See the T6963C_Init routine.
Example	<pre>' set text panel 1 as current text panel. T6963C_SetTxtPanel(1)</pre>

T6963C_PanelFill

Prototype	<code>sub procedure T6963C_PanelFill(dim v as byte)</code>
Returns	Nothing.
Description	Fill current panel in full (graphic+text) with appropriate value (0 to clear). Parameters : - v : value to fill panel with.
Requires	Toshiba Glcd module needs to be initialized. See the T6963C_Init routine.
Example	<code>clear current panel T6963C_PanelFill(0)</code>

T6963C_GrFill

Prototype	<code>sub procedure T6963C_PanelFill(dim v as byte)</code>
Returns	Nothing.
Description	Fill current panel in full (graphic+text) with appropriate value (0 to clear). Parameters : - v : value to fill panel with.
Requires	Toshiba Glcd module needs to be initialized. See the T6963C_Init routine.
Example	<code>clear current panel T6963C_PanelFill(0)</code>

T6963C_TxtFill

Prototype	<code>sub procedure T6963C_TxtFill(dim v as byte)</code>
Returns	Nothing.
Description	Fill current text panel with appropriate value (0 to clear). Parameters : - v : this value increased by 32 will be used to fill text panel.
Requires	Toshiba Glcd module needs to be initialized. See the T6963C_Init routine.
Example	<code>' clear current text panel T6963C_TxtFill(0)</code>

T6963C_Cursor_Height

Prototype	<code>sub procedure T6963C_Cursor_Height(dim n as byte)</code>
Returns	Nothing.
Description	Set cursor size. Parameters : - <code>n</code> : cursor height. Valid values: 0..7.
Requires	Toshiba Glcd module needs to be initialized. See the T6963C_Init routine.
Example	<code>T6963C_Cursor_Height(7)</code>

T6963C_Graphics

Prototype	<code>sub procedure T6963C_Graphics(dim n as byte)</code>
Returns	Nothing.
Description	Enable/disable graphic displaying. Parameters : - <code>n</code> : on/off parameter. Valid values: 0 (disable graphic displaying) and 1 (enable graphic displaying).
Requires	Toshiba Glcd module needs to be initialized. See the T6963C_Init routine.
Example	<code>' enable graphic displaying T6963C_Graphics(1)</code>

T6963C_Text

Prototype	<code>sub procedure T6963C_Text(dim n as byte)</code>
Returns	Nothing.
Description	Enable/disable text displaying. Parameters : - <code>n</code> : on/off parameter. Valid values: 0 (disable text displaying) and 1 (enable text displaying).
Requires	Toshiba Glcd module needs to be initialized. See the T6963C_Init routine.
Example	<code>' enable text displaying T6963C_Text(1)</code>

T6963C_Cursor

Prototype	<code>sub procedure T6963C_Cursor(dim n as byte)</code>
Returns	Nothing.
Description	Set cursor on/off. Parameters : - n : on/off parameter. Valid values: 0 (set cursor off) and 1 (set cursor on).
Requires	Toshiba Glcd module needs to be initialized. See the T6963C_Init routine.
Example	<pre>' set cursor on T6963C_Cursor(1)</pre>

T6963C_Cursor_Blink

Prototype	<code>sub procedure T6963C_Cursor_Blink(dim n as byte)</code>
Returns	Nothing.
Description	Enable/disable cursor blinking. Parameters : - n : on/off parameter. Valid values: 0 (disable cursor blinking) and 1 (enable cursor blinking).
Requires	Toshiba Glcd module needs to be initialized. See the T6963C_Init routine.
Example	<pre>' enable cursor blinking T6963C_Cursor_Blink(1)</pre>

Library Example

The following drawing demo tests advanced routines of the T6963C Glcd library. Hardware configurations in this example are made for the T6963C 240x128 display, EasyAVR5A board and ATmega16.

```

program T6963C_240x128

include __Lib_T6963C_Consts
include bitmap
include bitmap2

' T6963C module connections
dim T6963C_ctrlPort as byte at PORTC           ' CONTROL port
dim T6963C_dataPort as byte at PORTD         ' DATA port
dim T6963C_ctrlPort_Direction as byte at DDRC ' CONTROL direc-
tion register
dim T6963C_dataPort_Direction as byte at DDRD ' DATA direc-
tion register

dim T6963C_ctrlwr as sbit at PORTC.B2       ' WR write signal
dim T6963C_ctrlrd as sbit at PORTC.B1       ' RD read signal
dim T6963C_ctrlcd as sbit at PORTC.B0       ' CD command/data signal
dim T6963C_ctrlrst as sbit at PORTC.B4      ' RST reset signal
dim T6963C_ctrlwr_Direction as sbit at DDRC.B2 ' WR write sig-
nal direction
dim T6963C_ctrlrd_Direction as sbit at DDRC.B1 ' RD read sig-
nal direction
dim T6963C_ctrlcd_Direction as sbit at DDRC.B0 ' CD
command/data signal direction
dim T6963C_ctrlrst_Direction as sbit at DDRC.B4 ' RST reset
signal direction

' Signals not used by library, they are set in main sub function
dim T6963C_ctrlce as sbit at PORTC.B3       ' CE signal
dim T6963C_ctrlfs as sbit at PORTC.B6       ' FS signal
dim T6963C_ctrlmd as sbit at PORTC.B5       ' MD signal
dim T6963C_ctrlce_Direction as sbit at DDRC.B3 ' CE signal
direction
dim T6963C_ctrlfs_Direction as sbit at DDRC.B6 ' FS signal
direction
dim T6963C_ctrlmd_Direction as sbit at DDRC.B5 ' MD signal
direction
' End T6963C module connections

dim panel as byte           ' current panel
      i as word             ' general purpose register
      curs as byte         ' cursor visibility
      cposx,
      cposy as word        ' cursor x-y position
      txtcols as byte      ' number of text coloms
      txt, txt1 as string[ 29]

txt1 = " EINSTEIN WOULD HAVE LIKED mE"
txt  = " GLCD LIBRARY DEMO, WELCOME !"

```

```

DDRA = 0x00           ' configure PORTA as input

DDA0_bit = 0         ' Set PB0 as input
DDA1_bit = 0         ' Set PB1 as input
DDA2_bit = 0         ' Set PB2 as input
DDA3_bit = 0         ' Set PB3 as input
DDA4_bit = 0         ' Set PB4 as input

T6963C_ctrlce_Direction = 1
T6963C_ctrlce = 0     ' Enable T6963C
T6963C_ctrlfs_Direction = 1
T6963C_ctrlfs = 0     ' Font Select 8x8
T6963C_ctrlmd_Direction = 1
T6963C_ctrlmd = 0     ' Column number select

panel = 0
i = 0
curs = 0
cposx = 0
cposy = 0

' Initialize T6369C
T6963C_init(240, 128, 8)

{ *
 * Enable both graphics and text display at the same time
 *}
T6963C_graphics(1)
T6963C_text(1)

{ *
 * Text messages
 *}
T6963C_write_text(txt, 0, 0, T6963C_ROM_MODE_XOR)
T6963C_write_text(txt1, 0, 15, T6963C_ROM_MODE_XOR)

{ *
 * Cursor
 *}
T6963C_cursor_height(8)      ' 8 pixel height
T6963C_set_cursor(0, 0)     ' Move cursor to top left
T6963C_cursor(0)           ' Cursor off

{ *
 * Draw rectangles
 *}
T6963C_rectangle(0, 0, 239, 127, T6963C_WHITE)
T6963C_rectangle(20, 20, 219, 107, T6963C_WHITE)
T6963C_rectangle(40, 40, 199, 87, T6963C_WHITE)
T6963C_rectangle(60, 60, 179, 67, T6963C_WHITE)

```

```

{ *
  * Draw a cross
  *}
T6963C_line(0, 0, 239, 127, T6963C_WHITE)
T6963C_line(0, 127, 239, 0, T6963C_WHITE)

{ *
  * Draw solid boxes
  *}
T6963C_box(0, 0, 239, 8, T6963C_WHITE)
T6963C_box(0, 119, 239, 127, T6963C_WHITE)
  'while true do nop
{ *
  * Draw circles
  *}
T6963C_circle(120, 64, 10, T6963C_WHITE)
T6963C_circle(120, 64, 30, T6963C_WHITE)
T6963C_circle(120, 64, 50, T6963C_WHITE)
T6963C_circle(120, 64, 70, T6963C_WHITE)
T6963C_circle(120, 64, 90, T6963C_WHITE)
T6963C_circle(120, 64, 110, T6963C_WHITE)
T6963C_circle(120, 64, 130, T6963C_WHITE)

T6963C_sprite(76, 4, @einstein, 88, 119)      ' Draw a sprite
T6963C_setGrPanel(1)      ' Select other graphic panel
T6963C_image(@mikroe)

while TRUE      ' Endless loop

  '*
  '* If PORTA_0 is pressed, toggle the display between graphic
panel 0 and graphic 1
  '*
  if( PINA0_bit = 0) then
    Inc(panel)
    panel = panel and 1
    T6963C_setPtr((T6963C_grMemSize + T6963C_txtMemSize) * panel,
T6963C_GRAPHIC_HOME_ADDRESS_SET)
    Delay_ms(300)

  '*
  '* If PORTA_1 is pressed, display only graphic panel
  '*
  else
    if ( PINA1_bit = 0) then
      T6963C_graphics(1)
      T6963C_text(0)
      Delay_ms(300)

```



```
    '*  
    '* Move cursor, even if not visible  
    '*  
    Inc(cposx)  
    if (cpox = T6963C_txtCols) then  
        cposx = 0  
        Inc(cposy)  
        if (cposy = T6963C_grHeight / T6963C_CHARACTER_HEIGHT) then  
            cposy = 0  
        end if  
    end if  
    T6963C_set_cursor(cposx, cposy)  
  
    Delay_ms(100)  
wend  
end.
```

HW Connection

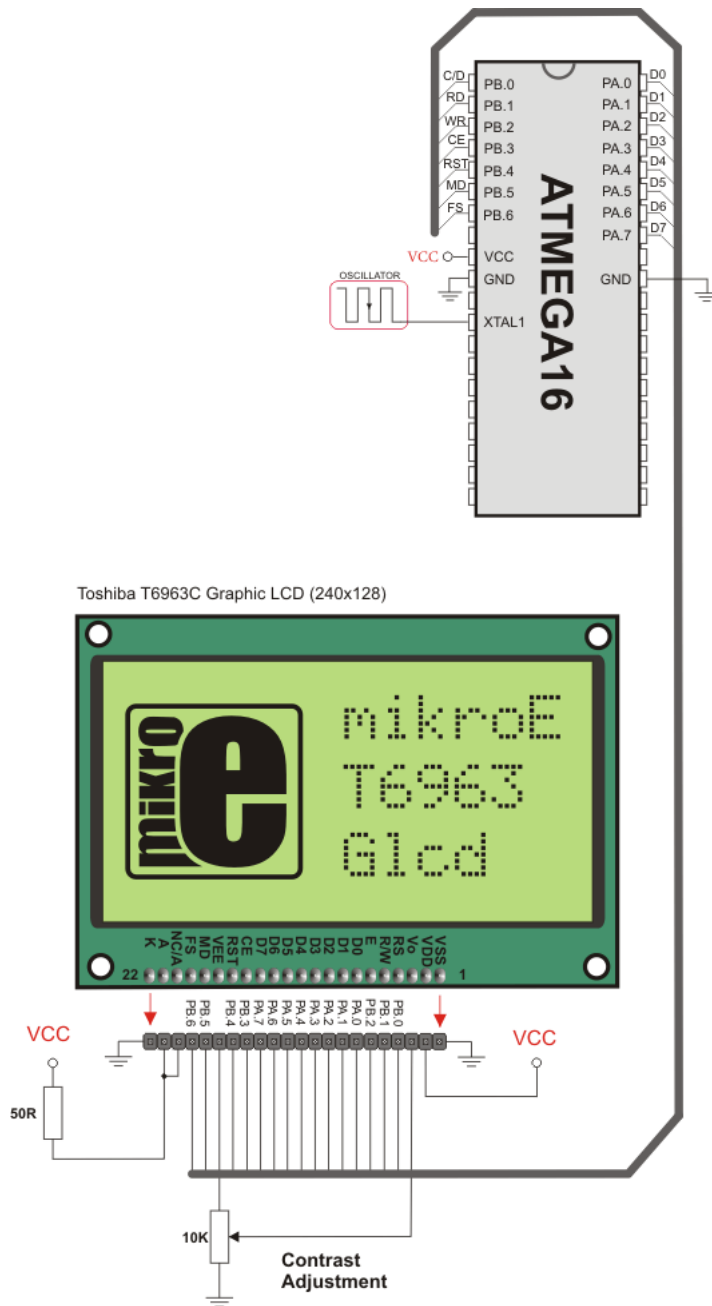

T6963C Glcd HW connection

TWI LIBRARY

TWI full master MSSP module is available with a number of AVR MCU models. mikroBasic PRO for AVR provides library which supports the master TWI mode.

Library Routines

- TWI_Init
- TWI_Busy
- TWI_Start
- TWI_Stop
- TWI_Read
- TWI_Write
- TWI_Status
- TWI_Close

TWI_Init

Prototype	<code>sub procedure TWI_Init(dim clock as longword)</code>
Returns	Nothing.
Description	Initializes TWI with desired <code>clock</code> (refer to device data sheet for correct values in respect with <code>Fosc</code>). Needs to be called before using other functions of TWI Library. You don't need to configure ports manually for using the module; library will take care of the initialization.
Requires	Library requires MSSP module on PORTB or PORTC.
Example	<code>TWI_Init(100000)</code>

TWI_Busy

Prototype	<code>sub function TWI_Busy() as byte</code>
Returns	Returns 0 if TWI start sequence is finished, 1 if TWI start sequence is not finished.
Description	Signalizes the status of TWI bus.
Requires	TWI must be configured before using this function. See <code>TWI_Init</code> .
Example	<pre>if (TWI_Busy = 1) ... end if</pre>

TWI_Start

Prototype	<code>sub function TWI_Start() as byte</code>
Returns	If there is no error function returns 0, otherwise returns 1.
Description	Determines if TWI bus is free and issues START signal.
Requires	TWI must be configured before using this function. See TWI_Init.
Example	<pre>if (TWI_Start = 1) ... end if</pre>

TWI_Read

Prototype	<code>sub function TWI_Read(dim ack as byte) as byte</code>
Returns	Returns one byte from the slave.
Description	Reads one byte from the slave, and sends not acknowledge signal if parameter ack is 0, otherwise it sends acknowledge.
Requires	TWI must be configured before using this function. See TWI_Init. Also, START signal needs to be issued in order to use this function. See TWI_Start.
Example	Read data and send not acknowledge signal: <pre>tmp = TWI_Read(0)</pre>

TWI_Write

Prototype	<code>sub procedure TWI_Write(dim data_ as byte)</code>
Returns	Nothing.
Description	Sends data byte (parameter data_) via TWI bus.
Requires	TWI must be configured before using this function. See TWI_Init. Also, START signal needs to be issued in order to use this function. See TWI_Start.
Example	<pre>TWI_Write(0xA3)</pre>

TWI_Stop

Prototype	<code>sub procedure TWI_Stop()</code>
Returns	Nothing.
Description	Issues STOP signal to TWI operation.
Requires	TWI must be configured before using this function. See TWI_Init.
Example	<code>TWI_Stop()</code>

TWI_Status

Prototype	<code>sub function TWI_Status() as byte</code>
Returns	Returns value of status register (TWSR), the highest 5 bits.
Description	Returns status of TWI.
Requires	TWI must be configured before using this function. See TWI_Init.
Example	<code>status = TWI_Status()</code>

TWI_Close

Prototype	<code>sub procedure TWI_Close()</code>
Returns	Nothing.
Description	Closes TWI connection.
Requires	TWI must be configured before using this function. See TWI_Init.
Example	<code>TWI_Close()</code>

Library Example

This code demonstrates use of TWI Library procedures and functions. AVR MCU is connected (SCL, SDA pins) to 24c02 EEPROM. Program sends data to EEPROM (data is written at address 2). Then, we read data via TWI from EEPROM and send its value to PORTA, to check if the cycle was successful. Check the figure below.

program TWI_Simple

```

main:
    DDRA = 0xFF                ' configure PORTA as output

    TWI_Init(100000)          ' initialize TWI communication
    TWI_Start()              ' issue TWI start signal
    TWI_Write(0xA2)          ' send byte via TWI (device address + W)
    TWI_Write(2)             ' send byte (address of EEPROM location)
    TWI_Write(0xAA)         ' send data (data to be written)
    TWI_Stop()              ' issue TWI stop signal

    Delay_100ms()

    TWI_Start()              ' issue TWI start signal
    TWI_Write(0xA2)          ' send byte via TWI (device address + W)
    TWI_Write(2)             ' send byte (data address)
    TWI_Start()              ' issue TWI signal repeated start
    TWI_Write(0xA3)          ' send byte (device address + R)
    PORTA = TWI_Read(0)      ' read data (NO acknowledge)
    TWI_Stop()              ' issue TWI stop signal}
end.

```

HW Connection

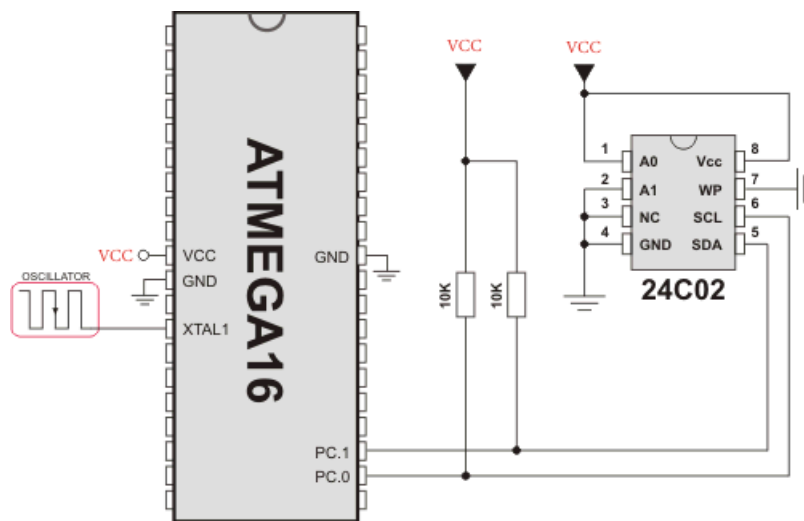

Interfacing 24c02 to AVR via TWI

UART LIBRARY

UART hardware module is available with a number of AVR MCUs. mikroBasic PRO for AVR UART Library provides comfortable work with the Asynchronous (full duplex) mode.

You can easily communicate with other devices via RS-232 protocol (for example with PC, see the figure at the end of the topic – RS-232 HW connection). You need a AVR MCU with hardware integrated UART, for example ATmega16. Then, simply use the functions listed below.

Library Routines

- UARTx_Init
- UARTx_Init_Advanced
- UARTx_Data_Ready
- UARTx_Read
- UARTx_Read_Text
- UARTx_Write
- UARTx_Write_Text

The following routine is for the internal use by compiler only:

- UARTx_TX_Idle

Note: AVR MCUs require you to specify the module you want to use. To select the desired UART, simply change the letter *x* in the prototype for a number from 1 to 4. Number of UART modules per MCU differs from chip to chip. Please, read the appropriate datasheet before utilizing this library.

Example: `UART2_Init()` initializes UART 2 module.

Note: Some of the AVR MCUs do not support `UARTx_Init_Advanced` routine. Please, refer to the appropriate datasheet.

UARTx_Init

Prototype	<code>sub procedure UARTx_Init(dim baud_rate as longint)</code>
Returns	Nothing.
Description	<p>Configures and initializes the UART module.</p> <p>The internal UART module module is set to:</p> <ul style="list-style-type: none"> - receiver enabled - transmitter enabled - frame size 8 bits - 1 STOP bit - parity mode disabled - asynchronous operation <p>Parameters :</p> <ul style="list-style-type: none"> - <code>baud_rate</code>: requested baud rate <p>Refer to the device data sheet for baud rates allowed for specific Fosc.</p>
Requires	<p>You'll need AVR MCU with hardware UART.</p> <p>UARTx_Init needs to be called before using other functions from UART Library.</p>
Example	<pre>'This will initialize hardware UART1 module and establish the communication at 2400 bps UART1_Init(2400)</pre>

UARTx_Init_Advanced

Prototype	<code>sub procedure UARTx_Init_Advanced(dim baud_rate as longword, dim parity as byte, dim stop_bits as byte)</code>	
Returns	Nothing.	
Description	Configures and initializes UART module.	
	Parameter <code>baud_rate</code> configures UART module to work on a requested baud rate. Parameters <code>parity</code> and <code>stop_bits</code> determine the work mode for UART, and can have the following values:	
	Mask	Description
	Parity constants:	
	0x00	Parity mode disabled
	0x20	Even parity
	0x30	Odd parity
	Stop bit constants:	
	0x00	1 stop bit
	0x01	2 stop bits
Note: Some MCUs do not support advanced configuration of the UART module. Please consult appropriate daatsheet.		
Requires	MCU must have UART module.	
Example	<pre>' Initialize hardware UART1 module and establish communication at 9600 bps, 8-bit data, even parity and 2 STOP bits UART1_Init_Advanced(9600, _UART_EVENPARITY, _UART_TWO_STOPBITS)</pre>	

UARTx_Data_Ready

Prototype	<code>sub function UARTx_Data_Ready() as byte</code>
Returns	Function returns <code>1</code> if data is ready or <code>0</code> if there is no data.
Description	The function tests if data in receive buffer is ready for reading.
Requires	MCU with the UART module. The UART module must be initialized before using this routine. See the <code>UARTx_Init</code> routine.
Example	<pre>dim receive as byte ... ' read data if ready if (UART1_Data_Ready() = 1) then receive = UART1_Read()</pre>

UARTx_Read

Prototype	<code>sub function UARTx_Read() as byte</code>
Returns	Received byte.
Description	The function receives a byte via UART. Use the <code>UARTx_Data_Ready</code> function to test if data is ready first.
Requires	MCU with the UART module. The UART module must be initialized before using this routine. See <code>UARTx_Init</code> routine.
Example	<pre>dim receive as byte ... ' read data if ready if (UART1_Data_Ready() = 1) then receive = UART1_Read()</pre>

UARTx_Read_Text

Prototype	<code>sub procedure UARTx_Read_Text(dim byref Output as string[255], dim byref Delimiter as string[10], dim Attempts as byte)</code>
Returns	Nothing.
Description	<p>Reads characters received via UART until the delimiter sequence is detected. The read sequence is stored in the parameter <code>output</code>; delimiter sequence is stored in the parameter <code>delimiter</code>.</p> <p>This is a blocking call: the delimiter sequence is expected, otherwise the procedure exits(if the delimiter is not found). Attempts defines number of received characters in which Delimiter sequence is expected. If Attempts is set to 255, this routine will continuously try to detect the Delimiter sequence.</p>
Requires	UART HW module must be initialized and communication established before using this function. See UARTx_Init.
Example	<p>Read text until the sequence "OK" is received, and send back what's been received:</p> <pre> UART1_Init(4800) ' initialize UART module Delay_ms(100) while TRUE if (UART1_Data_Ready() = 1) ' if data is received UART1_Read_Text(output, 'delim', 10) ' reads text until 'delim' is found UART1_Write_Text(output) ' sends back text end if wend.</pre>

UARTx_Write

Prototype	<code>sub procedure UARTx_Write(dim TxData as byte)</code>
Returns	Nothing.
Description	The function transmits a byte via the UART module. Parameters : - TxData: data to be sent
Requires	MCU with the UART module. The UART module must be initialized before using this routine. See UARTx_Init routine.
Example	<pre>dim data_ as byte ... data_ = 0x1E UART1_Write(data_)</pre>

UARTx_Write_Text

Prototype	<code>sub procedure UARTx_Write_Text(dim byref uart_text as string[255])</code>
Returns	Nothing.
Description	Sends text (parameter uart_text) via UART. Text should be zero terminated.
Requires	UART HW module must be initialized and communication established before using this function. See UARTx_Init.
Example	<p>Read text until the sequence "OK" is received, and send back what's been received:</p> <pre>UART1_Init(4800) ' initialize UART module Delay_ms(100) while TRUE if (UART1_Data_Ready() = 1) ' if data is received UART1_Read_Text(output, 'delim', 10) ' reads text until ' delim' is found UART1_Write_Text(output) ' sends back text end if wend.</pre>

Library Example

This example demonstrates simple data exchange via UART. If MCU is connected to the PC, you can test the example from the mikroBasic PRO for AVR USART Terminal.

```

program UART
dim uart_rd as byte

main:
  UART1_Init(19200)      ' Initialize UART module at 9600 bps
  Delay_ms(100)         ' Wait for UART module to stabilize

  while TRUE           ' Endless loop
    if (UART1_Data_Ready() <> 0) then ' If data is received,
      uart_rd = UART1_Read() ' read the received data,
      UART1_Write(uart_rd)  ' and send data via UART
    end if
  wend
end.

```

HW Connection

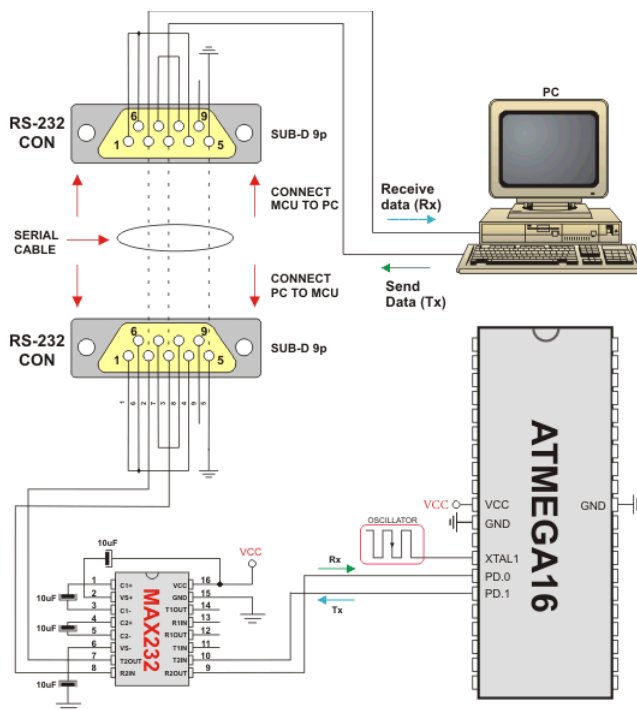

UART HW connection

BUTTON LIBRARY

The Button library contains miscellaneous routines useful for a project development.

External dependencies of Button Library

The following variable must be defined in all projects using Button library:	Description:	Example :
<code>dim Button_Pin as sbit sfr external</code>	Declares button pins.	<code>dim Button_Pin as sbit at PINB.B0</code>
<code>dim Button_Pin_Direction as sbit sfr external</code>	Declares direction of the button pin.	<code>dim Button_Pin_Direction as sbit at DDRB.B0</code>

Library Routines

- Button

Button

Prototype	<code>sub function Button(dim time_ms as byte, dim active_state as byte) as byte</code>
Returns	- 255 if the pin was in the active state for given period. - 0 otherwise
Description	The function eliminates the influence of contact flickering upon pressing a button (debouncing). The Button pin is tested just after the function call and then again after the debouncing period has expired. If the pin was in the active state in both cases then the function returns 255 (true). Parameters : - <code>time_ms</code> : debouncing period in milliseconds - <code>active_state</code> : determines what is considered as active state. Valid values: 0 (logical zero) and 1 (logical one)
Requires	Global variables : - <code>Button_Pin</code> : Button pin line - <code>Button_Pin_Direction</code> : Direction of the button pin must be defined before using this function.

Example	PORTC is inverted on every PORTB.B0 one-to-zero transition :
	<pre> program Button ' Button connections dim Button_Pin as sbit at PINB.B0 dim Button_Pin_Direction as sbit at DDRB.B0 ' End Button connections dim oldstate as bit ' Old state flag main: Button_Pin_Direction = 0 ' Set Button pin as input DDRC = 0xFF ' Configure PORTC as output PORTC = 0xAA ' Initial PORTC value oldstate = 0 ' oldstate initial value while TRUE if (Button(1, 1) = 1) ' Detect logical one oldstate = 1 ' Update flag end if if (oldstate and Button(1, 0)) then ' Detect one-to-zero transition PORTC = not PORTC ' Invert PORTC oldstate = 0 ' Update flag end if wend ' Endless loop end. </pre>

CONVERSIONS LIBRARY

mikroBasic PRO for AVR Conversions Library provides routines for numerals to strings and BCD/decimal conversions.

Library Routines

You can get text representation of numerical value by passing it to one of the following routines:

- ByteToStr
- ShortToStr
- WordToStr
- IntToStr
- LongintToStr
- LongWordToStr
- FloatToStr

The following sub functions convert decimal values to BCD and vice versa:

- Dec2Bcd
- Bcd2Dec16
- Dec2Bcd16

ByteToStr

Prototype	<code>sub procedure ByteToStr(dim input as word, dim byref output as string[2])</code>
Returns	Nothing.
Description	<p>Converts input byte to a string. The output string is right justified and remaining positions on the left (if any) are filled with blanks.</p> <p>Parameters :</p> <ul style="list-style-type: none"> - <code>input</code>: byte to be converted - <code>output</code>: destination string
Requires	Nothing.
Example	<pre>dim t as word txt as string[2] ... t = 24 ByteToStr(t, txt) ' txt is " 24" (one blank here)</pre>

ShortToStr

Prototype	<code>sub procedure ShortToStr(dim input as short, dim byref output as string[3])</code>
Returns	Nothing.
Description	<p>Converts input short (signed byte) number to a string. The output string is right justified and remaining positions on the left (if any) are filled with blanks.</p> <p>Parameters :</p> <ul style="list-style-type: none"> - <code>input</code>: short number to be converted - <code>output</code>: destination string
Requires	Nothing.
Example	<pre>dim t as short txt as string[3] ... t = -24 ByteToStr(t, txt) ' txt is " -24" (one blank here)</pre>

WordToStr

Prototype	<code>sub procedure WordToStr(dim input as word, dim byref output as string[4])</code>
Returns	Nothing.
Description	<p>Converts input word to a string. The output string is right justified and the remaining positions on the left (if any) are filled with blanks.</p> <p>Parameters :</p> <ul style="list-style-type: none"> - <code>input</code>: word to be converted - <code>output</code>: destination string
Requires	Nothing.
Example	<pre>dim t as word txt as string[4] ... t = 437 WordToStr(t, txt) ' txt is " 437" (two blanks here)</pre>

IntToStr

Prototype	<code>sub procedure IntToStr(dim input as integer, dim byref output as string[5])</code>
Returns	Nothing.
Description	<p>Converts input integer number to a string. The output string is right justified and the remaining positions on the left (if any) are filled with blanks.</p> <p>Parameters :</p> <ul style="list-style-type: none"> - <code>input</code>: integer number to be converted - <code>output</code>: destination string
Requires	Nothing.
Example	<pre>dim input as integer txt as string[5] '...' input = -4220 IntToStr(input, txt) ' txt is ' -4220'</pre>

LongintToStr

Prototype	<code>sub procedure LongintToStr(dim input as longint, dim byref output as string[10])</code>
Returns	Nothing.
Description	<p>Converts input longint number to a string. The output string is right justified and the remaining positions on the left (if any) are filled with blanks.</p> <p>Parameters :</p> <ul style="list-style-type: none"> - <code>input</code>: longint number to be converted - <code>output</code>: destination string
Requires	Nothing.
Example	<pre>dim input as longint txt as string[10] '...' input = -12345678 IntToStr(input, txt) ' txt is ' -12345678'</pre>

LongWordToStr

Prototype	<code>sub procedure LongWordToStr(dim input as longword, dim byref output as string[9])</code>
Returns	Nothing.
Description	<p>Converts input double word number to a string. The output string is right justified and the remaining positions on the left (if any) are filled with blanks.</p> <p>Parameters :</p> <ul style="list-style-type: none"> - <code>input</code>: double word number to be converted - <code>output</code>: destination string
Requires	Nothing.
Example	<pre>dim input as longint txt as string[9] '...' input = 12345678 IntToStr(input, txt) ' txt is ' 12345678'</pre>

FloatToStr

Prototype	<code>sub function FloatToStr(dim input as real, dim byref output as string[22])</code>
Returns	<ul style="list-style-type: none"> - 3 if input number is NaN - 2 if input number is -INF - 1 if input number is +INF - 0 if conversion was successful
Description	<p>Converts a floating point number to a string.</p> <p>Parameters :</p> <ul style="list-style-type: none"> - <code>input</code>: floating point number to be converted - <code>output</code>: destination string <p>The output string is left justified and null terminated after the last digit.</p> <p>Note: Given floating point number will be truncated to 7 most significant digits before conversion.</p>
Requires	Nothing.
Example	<pre>dim ff1, ff2, ff3 as real txt as string[22] ... ff1 = -374.2 ff2 = 123.456789 ff3 = 0.000001234 FloatToStr(ff1, txt) ' txt is "-374.2" FloatToStr(ff2, txt) ' txt is "123.4567" FloatToStr(ff3, txt) ' txt is "1.234e-6"</pre>

Dec2Bcd

Prototype	<code>sub function Dec2Bcd(dim decnum as byte) as byte</code>
Returns	Converted BCD value.
Description	Converts input number to its appropriate BCD representation. Parameters : - <code>decnum</code> : number to be converted
Requires	Nothing.
Example	<code>dim a, b as byte</code> <code>...</code> <code>a = 22</code> <code>b = Dec2Bcd(a) ' b equals 34</code>

Bcd2Dec16

Prototype	<code>sub function Bcd2Dec16(dim bcdnum as word) as word</code>
Returns	Converted decimal value.
Description	Converts 16-bit BCD numeral to its decimal equivalent. Parameters : - <code>bcdnum</code> : 16-bit BCD numeral to be converted
Requires	Nothing.
Example	<code>dim a, b as word</code> <code>...</code> <code>a = 0x1234 ' a equals 4660</code> <code>b = Bcd2Dec16(a) ' b equals 1234</code>

Dec2Bcd16

Prototype	<code>sub function Dec2Bcd16(dim decnum as word) as word</code>
Returns	Converted BCD value.
Description	<p>Converts decimal value to its BCD equivalent.</p> <p>Parameters :</p> <p>- <code>decnum</code> decimal number to be converted</p>
Requires	Nothing.
Example	<pre>dim a, b as word ... a = 2345 b = Dec2Bcd16(a) ' b equals 9029</pre>

MATH LIBRARY

The mikroBasic PRO for AVR provides a set of library functions for floating point math handling. See also Predefined Globals and Constants for the list of predefined math constants.

Library Functions

- acos
- asin
- atan
- atan2
- ceil
- cos
- cosh
- eval_poly
- exp
- fabs
- floor
- frexp
- ldexp
- log
- log10
- modf
- pow
- sin
- sinh
- sqrt
- tan
- tanh

acos

Prototype	<code>sub function acos(dim x as real) as real</code>
Description	The function returns the arc cosine of parameter x; that is, the value whose cosine is x. The input parameter x must be between -1 and 1 (inclusive). The return value is in radians, between 0 and π (inclusive).

asin

Prototype	<code>sub function asin(dim x as real) as real</code>
Description	The function returns the arc sine of parameter x; that is, the value whose sine is x. The input parameter x must be between -1 and 1 (inclusive). The return value is in radians, between $-\pi/2$ and $\pi/2$ (inclusive).

atan

Prototype	<code>sub function atan(dim arg as real) as real</code>
Description	The function computes the arc tangent of parameter <code>arg</code> ; that is, the value whose tangent is <code>arg</code> . The return value is in radians, between $-\pi/2$ and $\pi/2$ (inclusive).

atan2

Prototype	<code>sub function atan2(dim y as real, dim x as real) as real</code>
Description	This is the two-argument arc tangent function. It is similar to computing the arc tangent of y/x , except that the signs of both arguments are used to determine the quadrant of the result and x is permitted to be zero. The return value is in radians, between $-\pi$ and π (inclusive).

ceil

Prototype	<code>sub function ceil(dim x as real) as real</code>
Description	The function returns value of parameter <code>x</code> rounded up to the next whole number.

cos

Prototype	<code>sub function cos(dim arg as real) as real</code>
Description	The function returns the cosine of <code>arg</code> in radians. The return value is from -1 to 1.

cosh

Prototype	<code>sub function cosh(dim x as real) as real</code>
Description	The function returns the hyperbolic cosine of <code>x</code> , defined mathematically as $(e^x + e^{-x})/2$. If the value of <code>x</code> is too large (if overflow occurs), the function fails.

eval_poly

Prototype	<code>sub function eval_poly(dim x as real, dim byref d as array[10] of real, dim n as integer) as real</code>
Description	Function Calculates polynomial for number <code>x</code> , with coefficients stored in <code>d[]</code> , for degree <code>n</code> .

exp

Prototype	<code>sub function exp(dim x as real) as real</code>
Description	The function returns the value of e — the base of natural logarithms — raised to the power x (i.e. e^x).

fabs

Prototype	<code>sub function fabs(dim d as real) as real</code>
Description	The function returns the absolute (i.e. positive) value of d .

floor

Prototype	<code>sub function floor(dim x as real) as real</code>
Description	The function returns the value of parameter x rounded down to the nearest integer.

frexp

Prototype	<code>sub function frexp(dim value as real, dim byref eptr as integer) as real</code>
Description	The function splits a floating-point value $value$ into a normalized fraction and an integral power of 2. The return value is a normalized fraction and the integer exponent is stored in the object pointed to by $eptr$.

ldexp

Prototype	<code>sub function ldexp(dim value as real, dim newexp as integer) as real</code>
Description	The function returns the result of multiplying the floating-point number $value$ by 2 raised to the power $newexp$ (i.e. returns $value * 2^{newexp}$).

log

Prototype	<code>sub function log(dim x as real) as real</code>
Description	The function returns the natural logarithm of x (i.e. $\log_e(x)$).

log10

Prototype	<code>sub function log10(dim x as real) as real</code>
Description	The function returns the base-10 logarithm of x (i.e. $\log_{10}(x)$).

modf

Prototype	<code>sub function modf(dim val as real, dim byref iptr as real) as real</code>
Description	The function returns the signed fractional component of <code>val</code> , placing its whole number component into the variable pointed to by <code>iptr</code> .

pow

Prototype	<code>sub function pow(dim x as real, dim y as real) as real</code>
Description	The function returns the value of <code>x</code> raised to the power <code>y</code> (i.e. x^y). If <code>x</code> is negative, the function will automatically cast <code>y</code> into <code>longint</code> .

sin

Prototype	<code>sub function sin(dim arg as real) as real</code>
Description	The function returns the sine of <code>arg</code> in radians. The return value is from -1 to 1.

sinh

Prototype	<code>sub function sinh(dim x as real) as real</code>
Description	The function returns the hyperbolic sine of <code>x</code> , defined mathematically as $(e^x - e^{-x}) / 2$. If the value of <code>x</code> is too large (if overflow occurs), the function fails.

sqrt

Prototype	<code>sub function sqrt(dim x as real) as real</code>
Description	The function returns the non negative square root of <code>x</code> .

tan

Prototype	<code>sub function tan(dim x as real) as real</code>
Description	The function returns the tangent of <code>x</code> in radians. The return value spans the allowed range of floating point in mikroBasic PRO for AVR.

tanh

Prototype	<code>sub function tanh(dim x as real) as real</code>
Description	The function returns the hyperbolic tangent of <code>x</code> , defined mathematically as $\sinh(x) / \cosh(x)$.

STRING LIBRARY

The mikroBasic PRO for AVR includes a library which automatizes string related tasks.

Library Functions

- memchr
- memcmp
- memcpy
- memmove
- memset
- strcat
- strchr
- strcmp
- strcpy
- strlen
- strncat
- strncpy
- strspn
- strcspn
- strncmp
- strpbrk
- strrchr
- strstr

memchr

Prototype	<code>sub function memchr(dim p as ^byte, dim ch as byte, dim n as word) as word</code>
Description	<p>The function locates the first occurrence of the word <code>ch</code> in the initial <code>n</code> words of memory area starting at the address <code>p</code>. The function returns the offset of this occurrence from the memory address <code>p</code> or <code>0xFFFF</code> if <code>ch</code> was not found.</p> <p>For the parameter <code>p</code> you can use either a numerical value (literal/variable/constant) indicating memory address or a dereferenced value of an object, for example <code>@mystring</code> or <code>@PORTB</code>.</p>

memcmp

Prototype	<code>sub function memcmp(dim p1, p2 as ^byte, dim n as word) as integer</code>								
Description	<p>The function returns a positive, negative, or zero value indicating the relationship of first n words of memory areas starting at addresses <code>p1</code> and <code>p2</code>.</p> <p>This function compares two memory areas starting at addresses <code>p1</code> and <code>p2</code> for n words and returns a value indicating their relationship as follows:</p> <table> <thead> <tr> <th>Value</th> <th>Meaning</th> </tr> </thead> <tbody> <tr> <td>< 0</td> <td>p1 "less than" p2</td> </tr> <tr> <td>= 0</td> <td>p1 "equal to" p2</td> </tr> <tr> <td>> 0</td> <td>p1 "greater than" p2</td> </tr> </tbody> </table> <p>The value returned by the function is determined by the difference between the values of the first pair of words that differ in the strings being compared.</p> <p>For parameters <code>p1</code> and <code>p2</code> you can use either a numerical value (literal/variable/constant) indicating memory address or a dereferenced value of an object, for example <code>@mystring</code> or <code>@PORTB</code>.</p>	Value	Meaning	< 0	p1 "less than" p2	= 0	p1 "equal to" p2	> 0	p1 "greater than" p2
Value	Meaning								
< 0	p1 "less than" p2								
= 0	p1 "equal to" p2								
> 0	p1 "greater than" p2								

memcpy

Prototype	<code>sub procedure memcpy(dim p1, p2 as ^byte, dim nn as word)</code>
Description	<p>The function copies nn words from the memory area starting at the address <code>p2</code> to the memory area starting at <code>p1</code>. If these memory buffers overlap, the memcpy function cannot guarantee that words are copied before being overwritten. If these buffers do overlap, use the memmove function.</p> <p>For parameters <code>p1</code> and <code>p2</code> you can use either a numerical value (literal/variable/constant) indicating memory address or a dereferenced value of an object, for example <code>@mystring</code> or <code>@PORTB</code>.</p>

memmove

Prototype	<code>sub procedure memmove(dim p1, p2, as ^byte, dim nn as word)</code>
Description	<p>The function copies nn words from the memory area starting at the address <code>p2</code> to the memory area starting at <code>p1</code>. If these memory buffers overlap, the Memmove function ensures that the words in <code>p2</code> are copied to <code>p1</code> before being overwritten.</p> <p>For parameters <code>p1</code> and <code>p2</code> you can use either a numerical value (literal/variable/constant) indicating memory address or a dereferenced value of an object, for example <code>@mystring</code> or <code>@PORTB</code>.</p>

memset

Prototype	<code>sub procedure memset (dim p as ^byte, dim character as byte, dim n as word)</code>
Description	The function fills the first n words in the memory area starting at the address p with the value of word character. For parameter p you can use either a numerical value (literal/variable/constant) indicating memory address or a dereferenced value of an object, for example @mystring or @PORTB.

strcat

Prototype	<code>sub procedure strcat (dim byref s1, s2 as string[100])</code>
Description	The function appends the value of string s2 to string s1 and terminates s1 with a null character.

strchr

Prototype	<code>sub function strchr (dim byref s as string[100] , dim ch as byte) as word</code>
Description	The function searches the string s for the first occurrence of the character ch. The null character terminating s is not included in the search. The function returns the position (index) of the first character ch found in s; if no matching character was found, the function returns 0xFFFF.

strcmp

Prototype	<code>sub function strcmp (dim byref s1, s2 as string[100]) as short</code>								
Description	The function lexicographically compares the contents of the strings s1 and s2 and returns a value indicating their relationship: <table border="0"> <thead> <tr> <th>Value</th> <th>Meaning</th> </tr> </thead> <tbody> <tr> <td>< 0</td> <td>s1 "less than" s2</td> </tr> <tr> <td>= 0</td> <td>s1 "equal to" s2</td> </tr> <tr> <td>> 0</td> <td>s1 "greater than" s2</td> </tr> </tbody> </table> The value returned by the function is determined by the difference between the values of the first pair of words that differ in the strings being compared.	Value	Meaning	< 0	s1 "less than" s2	= 0	s1 "equal to" s2	> 0	s1 "greater than" s2
Value	Meaning								
< 0	s1 "less than" s2								
= 0	s1 "equal to" s2								
> 0	s1 "greater than" s2								

strcpy

Prototype	<code>sub procedure strcpy(dim byref s1, s2 as string[100])</code>
Description	The function copies the value of the string <code>s2</code> to the string <code>s1</code> and appends a null character to the end of <code>s1</code> .

strcspn

Prototype	<code>sub function strcspn(dim byref s1, s2 as string[100]) as word</code>
Description	The function searches the string <code>s1</code> for any of the characters in the string <code>s2</code> . The function returns the index of the first character located in <code>s1</code> that matches any character in <code>s2</code> . If the first character in <code>s1</code> matches a character in <code>s2</code> , a value of 0 is returned. If there are no matching characters in <code>s1</code> , the length of the string is returned (not including the terminating null character).

strlen

Prototype	<code>sub function strlen(dim byref s as string[100]) as word</code>
Description	The function returns the length, in words, of the string <code>s</code> . The length does not include the null terminating character.

strncat

Prototype	<code>sub procedure strncat(dim byref s1, s2 as string[100] , dim size as byte)</code>
Description	The function appends at most <code>size</code> characters from the string <code>s2</code> to the string <code>s1</code> and terminates <code>s1</code> with a null character. If <code>s2</code> is shorter than the <code>size</code> characters, <code>s2</code> is copied up to and including the null terminating character.

strncmp

Prototype	<code>sub function strncmp(dim byref s1, s2 as string[100], dim len as byte) as short</code>								
Description	<p>The function lexicographically compares the first <code>len</code> words of the strings <code>s1</code> and <code>s2</code> and returns a value indicating their relationship:</p> <table> <thead> <tr> <th>Value</th> <th>Meaning</th> </tr> </thead> <tbody> <tr> <td>< 0</td> <td>s1 "less than" s2</td> </tr> <tr> <td>= 0</td> <td>s1 "equal to" s2</td> </tr> <tr> <td>> 0</td> <td>s1 "greater than" s2</td> </tr> </tbody> </table> <p>The value returned by the function is determined by the difference between the values of the first pair of words that differ in the strings being compared (within first <code>len</code> words).</p>	Value	Meaning	< 0	s1 "less than" s2	= 0	s1 "equal to" s2	> 0	s1 "greater than" s2
Value	Meaning								
< 0	s1 "less than" s2								
= 0	s1 "equal to" s2								
> 0	s1 "greater than" s2								

strncpy

Prototype	<code>sub procedure strncpy(dim byref s1, s2 as string[100], dim size as word)</code>
Description	The function copies at most <code>size</code> characters from the string <code>s2</code> to the string <code>s1</code> . If <code>s2</code> contains fewer characters than <code>size</code> , <code>s1</code> is padded out with null characters up to the total length of the <code>size</code> characters.

strpbrk

Prototype	<code>sub function strpbrk(dim byref s1, s2 as string[100]) as word</code>
Description	The function searches <code>s1</code> for the first occurrence of any character from the string <code>s2</code> . The null terminator is not included in the search. The function returns an index of the matching character in <code>s1</code> . If <code>s1</code> contains no characters from <code>s2</code> , the function returns <code>0xFFFF</code> .

strchr

Prototype	<code>sub function strchr(dim byref s as string[100], dim ch as byte) as word</code>
Description	The function searches the string <code>s</code> for the last occurrence of the character <code>ch</code> . The null character terminating <code>s</code> is not included in the search. The function returns an index of the last <code>ch</code> found in <code>s</code> ; if no matching character was found, the function returns <code>0xFFFF</code> .

strspn

Prototype	<code>sub function strspn(dim byref s1, s2 as string[100]) as byte</code>
Description	<p>The function searches the string <code>s1</code> for characters not found in the <code>s2</code> string.</p> <p>The function returns the index of first character located in <code>s1</code> that does not match a character in <code>s2</code>. If the first character in <code>s1</code> does not match a character in <code>s2</code>, a value of 0 is returned. If all characters in <code>s1</code> are found in <code>s2</code>, the length of <code>s1</code> is returned (not including the terminating null character).</p>

strstr

Prototype	<code>sub function strstr(dim byref s1, s2 as string[100]) as word</code>
Description	<p>The function locates the first occurrence of the string <code>s2</code> in the string <code>s1</code> (excluding the terminating null character).</p> <p>The function returns a number indicating the position of the first occurrence of <code>s2</code> in <code>s1</code>; if no string was found, the function returns <code>0xFFFF</code>. If <code>s2</code> is a null string, the function returns 0.</p>

TIME LIBRARY

The Time Library contains functions and type definitions for time calculations in the UNIX time format which counts the number of seconds since the "epoch". This is very convenient for programs that work with time intervals: the difference between two UNIX time values is a real-time difference measured in seconds.

What is the epoch?

Originally it was defined as the beginning of 1970 GMT. (January 1, 1970 Julian day) GMT, Greenwich Mean Time, is a traditional term for the time zone in England.

The TimeStruct type is a structure type suitable for time and date storage.

Library Routines

- Time_dateToEpoch
- Time_epochToDate
- Time_datediff

Time_dateToEpoch

Prototype	<code>sub function Time_dateToEpoch(dim byref ts as TimeStruct) as longint</code>
Returns	Number of seconds since January 1, 1970 0h00mn00s.
Description	This function returns the UNIX time : number of seconds since January 1, 1970 0h00mn00s. Parameters : - <code>ts</code> : time and date value for calculating UNIX time.
Requires	Nothing.
Example	<pre>dim ts1 as TimeStruct Epoch as longint ... ' what is the epoch of the date in ts ? epoch = Time_dateToEpoch(ts1)</pre>

Time_epochToDate

Prototype	<code>sub procedure Time_epochToDate(dim e as longint, dim byref ts as TimeStruct)</code>
Returns	Nothing.
Description	Converts the UNIX time to time and date. Parameters : - <code>e</code> : UNIX time (seconds since UNIX epoch) - <code>ts</code> : time and date structure for storing conversion output
Requires	Nothing.
Example	<pre>dim ts2 as TimeStruct epoch as longint ... ' what date is epoch 1234567890 ? epoch = 1234567890 Time_epochToDate(epoch,ts2)</pre>

Time_dateDiff

Prototype	<code>sub function Time_dateDiff(dim t1 as ^TimeStruct, dim t2 as ^TimeStruct) as longint</code>
Returns	Time difference in seconds as a signed long.
Description	This function compares two dates and returns time difference in seconds as a signed long. The result is positive if <code>t1</code> is before <code>t2</code> , null if <code>t1</code> is the same as <code>t2</code> and negative if <code>t1</code> is after <code>t2</code> . Parameters : - <code>t1</code> : time and date structure (the first comparison parameter) - <code>t2</code> : time and date structure (the second comparison parameter)
Requires	Nothing.
Example	<pre>dim ts1, ts2 as TimeStruct diff as longint ... ' how many seconds between these two dates contained in ts1 and ts2 buffers? diff = Time_dateDiff(ts1, ts2)</pre>

Library Example

Demonstration of Time library routines usage for time calculations in UNIX time format.

```

program Time_Demo

dim epoch, diff as longint

'*****
  ts1, ts2 as TimeStruct
'*****
main:

  ts1.ss = 0
  ts1.mn = 7
  ts1.hh = 17
  ts1.md = 23
  ts1.mo = 5
  ts1.yy = 2006

  ' *
  ' * What is the epoch of the date in ts ?
  ' *
  epoch = Time_dateToEpoch(@ts1)           ' 1148404020

  ' *
  ' * What date is epoch 1234567890 ?
  ' *
  epoch = 1234567890
  Time_epochToDate(epoch, @ts2)           ' { 0x1E, 0x1F, 0x17, 0x0D,
0x04, 0x02, 0x07D9)

  ' *
  ' * How much seconds between this two dates ?
  ' *
  diff = Time_dateDiff(@ts1, @ts2)       ' 86163870

end.

```

TimeStruct type definition

```

structure TimeStruct
  dim ss as byte   ' seconds
  dim mn as byte   ' minutes
  dim hh as byte   ' hours
  dim md as byte   ' day in month, from 1 to 31
  dim wd as byte   ' day in week, monday=0, tuesday=1, .... sunday=6
  dim mo as byte   ' month number, from 1 to 12 (and not from 0
to 11 as with unix C time !)
  dim yy as word   ' year Y2K compliant, from 1892 to 2038
end structure

```

TRIGONOMETRY LIBRARY

The mikroBasic PRO for AVR implements fundamental trigonometry functions. These functions are implemented as look-up tables. Trigonometry functions are implemented in integer format in order to save memory.

Library Routines

- sinE3
- cosE3

sinE3

Prototype	<code>sub function sinE3(dim angle_deg as word) as integer</code>
Returns	The function returns the sine of input parameter.
Description	<p>The function calculates sine multiplied by 1000 and rounded to the nearest integer:</p> <pre>result = round(sin(angle_deg)*1000)</pre> <p>Parameters:</p> <ul style="list-style-type: none"> - <code>angle_deg</code>: input angle in degrees <p>Note: Return value range: -1000..1000.</p>
Requires	Nothing.
Example	<pre>dim res as integer ... res = sinE3(45) ' result is 707</pre>

cosE3

Prototype	<code>sub function cosE3(dim angle_deg as word) as integer</code>
Returns	The function returns the cosine of input parameter.
Description	<p>The function calculates cosine multiplied by 1000 and rounded to the nearest integer:</p> <pre>result = round(cos(angle_deg)*1000)</pre> <p>Parameters:</p> <ul style="list-style-type: none"> - <code>angle_deg</code>: input angle in degrees <p>Note: Return value range: -1000..1000.</p>
Requires	Nothing.
Example	<pre>dim res as integer ... res = cosE3(196) ' result is -193</pre>



MikroElektronika

SOFTWARE AND HARDWARE SOLUTIONS FOR EMBEDDED WORLD

...making it simple

If you have any other question, comment or a business proposal, please contact us:

web: www.mikroe.com

e-mail: office@mikroe.com

If you are experiencing problems with any of our products

or you just want additional information, please let us know.

TECHNICAL SUPPORT: www.mikroe.com/en/support

