

48-56V adjustable, PFC

SL10.106

- Input: AC 230/115V, DC 240...375V
- Output: 48-56V/240W
- PULS Overload Design™: Power boost up to 288W; high overload current, no switch-off
- Robust mechanics and EMC

CB
scheme
IEC60950

UL

UL508 LISTED
IND. CONT. EQ.
18 WM, 60°C

CUL

UL60950 E137006
CUL/CSA-C22.2
No 60950

CE

EMC and
Low Volt.
Directive

Input

Input voltage	AC100-120/220-240V (switchable), 47-63 Hz (AC 85...132/176...264V, DC 240...375V)
---------------	--

Note: At DC input, always leave the switch in the 230V position

Input current I_n	<6A (switch in 115V position) <2.8A (switch in 230V position)
---------------------	--

Inrush current I_{pk}	<37A at AC 264V ($T_{amb} = +25^\circ\text{C}$, cold start) <62A at AC 264V ($T_{amb} = +50^\circ\text{C}$, cold start)
-------------------------	--

Fuse loading I^2t	<2.5A ² s ($T_{amb} = +25^\circ\text{C}$, cold start) <6A ² s ($T_{amb} = +50^\circ\text{C}$, cold start)
---------------------	--

DCin at open output	8mA (preserves battery sources)
---------------------	---------------------------------

Unit is internally fused (fuse not accessible). For external fusing of unit and for input line protection, use circuit breaker with B-characteristic 10A or slower action, or alternatively T10A HBC fuse.

Harmonic current emissions (PFC)	according to EN 61000-3-2 Power factor: better than 0.68 at nominal load
----------------------------------	---

Transient handling	Transient resistance acc. to VDE 0160 / W2 (750V/1.3ms), for all load conditions.
--------------------	--

Hold up time	>25ms at AC 196V, 48V/5A (see Diagram overleaf)
--------------	--

Efficiency, Reliability etc.*

Efficiency	>90% (AC 230V, 48V/5A)
------------	------------------------

Losses	<26.7W (AC 230V, 48V/5A)
--------	--------------------------

MTBF	425.000h acc. to Siemensnorm SN 29500 (48V/5A, AC 230V, $T_{amb} = +40^\circ\text{C}$)
------	--

Life cycle (electrolytics)	The unit uses longlife electrolytics, specified for +105°C (cf. 'The SilverLine', p.2).
----------------------------	---

* For further information see data sheets „The SilverLine“, „SilverLine Family Branches“ and mechanics data sheet

Output

Output voltage	DC 48-56V, adjustable by (covered) front panel potentiometer; preset: 48 V $\pm 0.5\%$ Adj. range guaranteed
----------------	---

Ambient temperature range T_{amb}	Operation: $0^\circ\text{C} \dots +70^\circ\text{C}$ ($>60^\circ\text{C}$: Derating) Storage: $-25^\circ\text{C} \dots +85^\circ\text{C}$
-------------------------------------	--

Rated continuous loading with convection cooling

- $T_{amb} = 0^\circ\text{C} - 60^\circ\text{C}$ 48V/5A (240W) resp. 56V/4.3A (240W)
- $T_{amb} = 0^\circ\text{C} - 45^\circ\text{C}$ 48V/6A (288W) resp. 56V/5.1A (288W)
short-term also at 60°C

Output is protected against short-circuit, open circuit and overload

Derating	typ. 6W/K (at $T_{amb} = +60^\circ\text{C} \dots +70^\circ\text{C}$)
----------	---

Voltage regulation	better than 2% V_{out} overall
--------------------	----------------------------------

Ripple / Noise	<50mV _{pp} , (20MHz bandw., 50Ω measurement)
----------------	---

Parallel operation	possible; however, no equal load sharing
--------------------	--

Overvolt. protection	typ. 59V
----------------------	----------

Power back immunity	60V
---------------------	-----

Front panel indicator	Green LED on front panel
-----------------------	--------------------------

Construction / Mechanics*

Housing dimensions and Weight

- W x H x D 120mm x 124mm x 102mm (+ DIN rail)
- Free space for ventilation above/below 25mm recommended
left/right 15mm recommended
- Weight 980g

Design advantages:

- All connection blocks are easy to reach as mounted at the front panel.

Ordering information

Order number

SL10.106
SLZ14
SLZ02

Description

SilverLine switched-mode power supply
Adapter for S7-300 rail
Wall mounting set

Start / Overload Behaviour

Startup delay	typ. 0.1s
Rise time	ca. 5-20ms, depending on load
Overload Behaviour	
<ul style="list-style-type: none"> Special PULS Overload Design (see diagram overleaf) 20% power boost 	<ul style="list-style-type: none"> no disconnection, no hiccup if overloaded high overload current (up to 1.6 I_{Nom}), V_{out} is gradually reduced with increasing current. 6A short-term, at 45°C or forced cooling even continuous

Advantages:

- High short-circuit current, giving large 'start-up window': unit starts reliably even with heavy loads (DC-DC converters, motors).
- No 'sticking' such as can occur with fold-back characteristics
- Secondary fuses operate more reliably

Further information

For further information, especially about

- EMC
- Connections
- Safety, Approvals
- Mechanics und Mounting,

see page 2 of the „The SilverLine“ data sheet.
For detailed dimensions
 see SilverLine mechanics data sheet SL2.5/ SL5/ SL10

Output characteristic (min.)

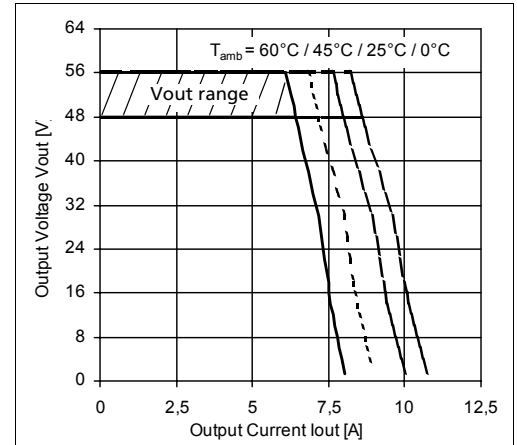

Efficiency

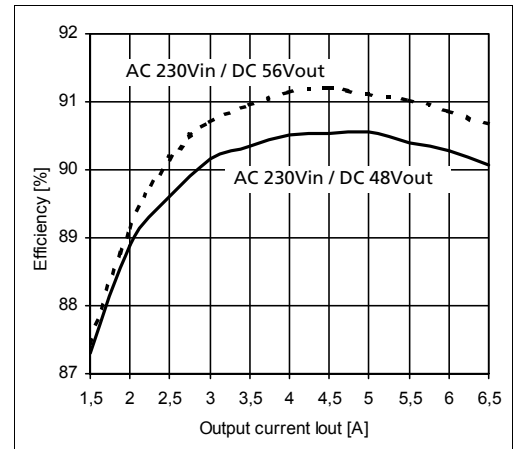

Hold-up time (typ., at V_{out}=48V)

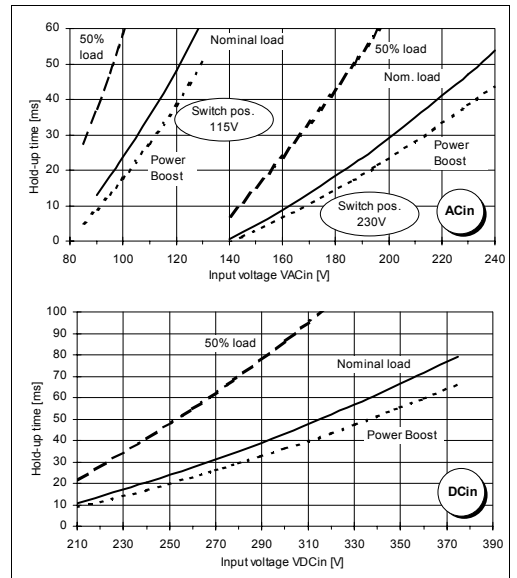

Alle Angaben gelten, sofern nicht anders angegeben, für AC 230V, +25°C Umgebungstemp. und 5 min. Einlaufzeit. Sie dienen ausschließlich der Produktbeschreibung und sind nicht als zugesicherte Eigenschaften im Rechtssinne aufzufassen. Änderungen vorbehalten.

Your partner in power supply:



European Power Supply Manufacturers Association



Bayerns Best 50
Czech 100 Best
Europe's 500

with 50% Load = 120W /

PULS GmbH

Arabellastraße 15
D-81925 München
Tel.: +49 89 9278-0
Fax: +49 89 9278-199
www.puls-power.com

SL2.5/ SL5/ SL10

- Innovative DIN-Rail mount, unit holds even at vibration or lateral pressure
- Clearly arranged and user oriented
- Large, robust screw terminals
- Sealed metal housing
- Fine ventilating grid



Data sheet

Side view SL2.5

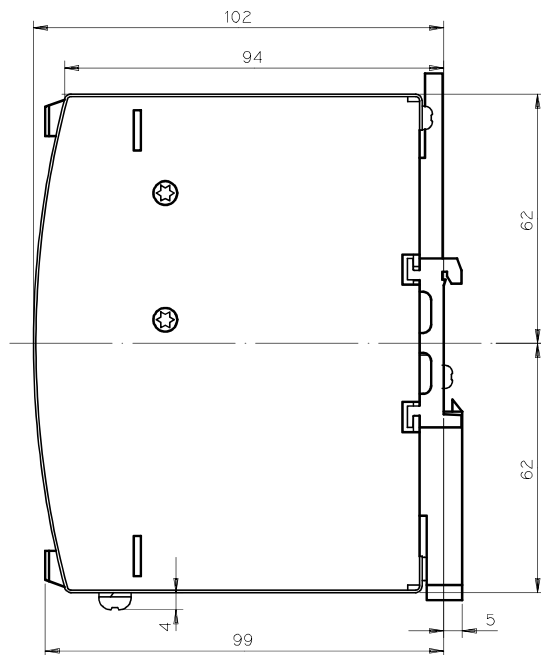

Front view SL2.5

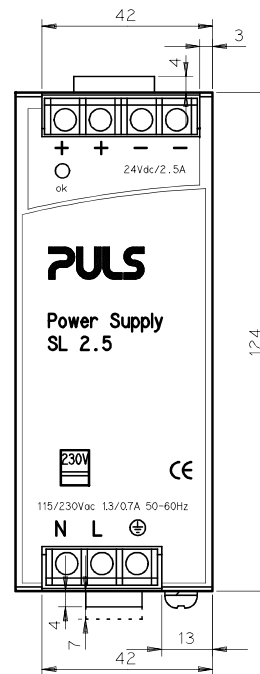

Bottom view SL2.5

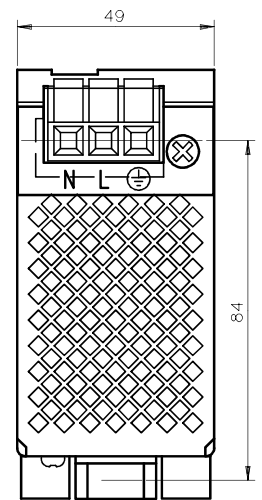

Construction / Mechanics

Housing dimensions and Weight		Free space for ventilation	
Unit	W x H x D [mm] weight	left	above/below right
• SL2.5	49 x 124 x 102 460 g	0 mm	25 mm each 10 mm
• SL5.10x	64 x 124 x 102 620 g	15 mm	25 mm each 15 mm
• SL5.300	73 x 124 x 117 730 g	15 mm	50 mm each 15 mm
• SL10	120 x 124 x 102 980 g	15 mm	25 mm each 15 mm

Overall depth = depth value as mentioned + DIN rail depth

Robust metal housing with fine ventilat. grid (◇ 3,5 mm, IP20), to keep out small parts (e.g. screws)

Mounting on DIN-Rail (TS35/7.5 or TS35/15, 1...1.5 mm thick), thus

- Simple snap-on system
- Sits safely and firmly on the DIN-Rail
- No tools required to remove

or backplane-mounted (two optional screw mounting sets SLZ01 required)

Connections

Connections

- Input/Output
- Current handling capacity
- Grid

Screw terminals, connector size range: solid 0.5- 6 mm² / flexible 0.5- 4 mm²
30 A per output
Two connectors per output, 9 mm distance between adjacent connectors

Design advantages:

- All connection blocks are easy to reach as mounted at the the front panel.
- Input and output are strictly apart from each other and so cannot be mixed up

Order information

Order number	Description
SL2.100	24V/2.5A
SL2.103	12-15V/40W
SL5.100	24V/5A
SL5.102	24-28V/120W
SL5.105	24-28V/120W
SL5.300	24-28V/120W, 3AC400-500V input
SL10.100 and SL10.105	24-28V/240W
SL10.101	48-56V/240W
SLZ01	Screw mounting set, two needed per unit

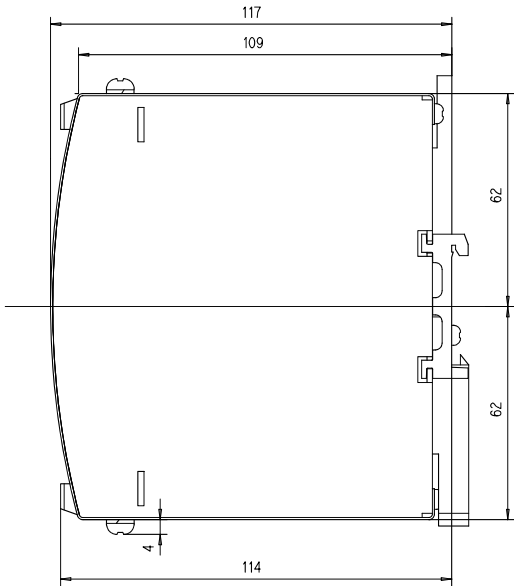

All views SL5.300

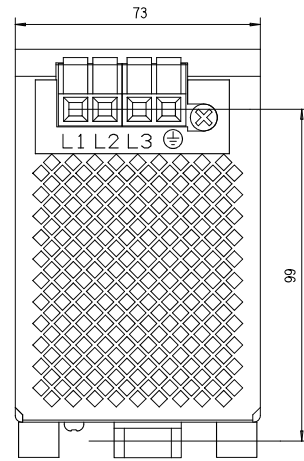
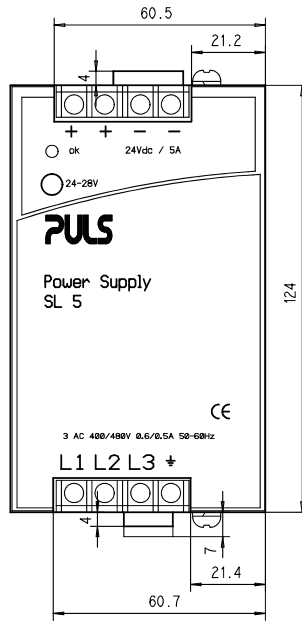

**Bottom view
SL10 SL5.10x**

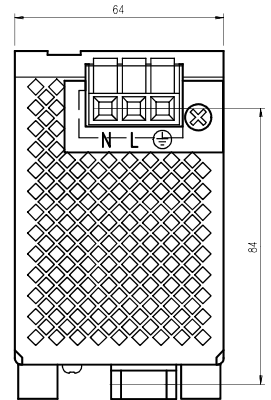
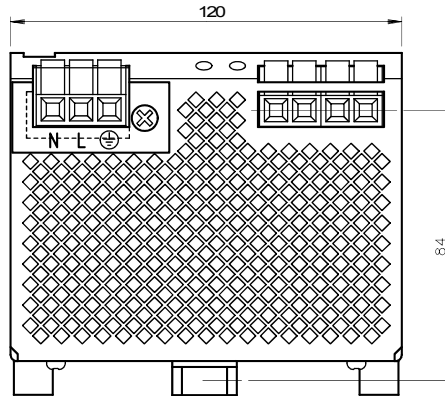

**Side view and front view
SL10, SL5.10x**

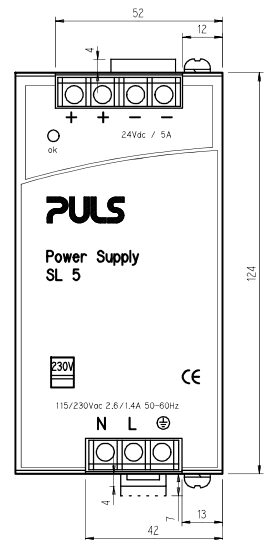
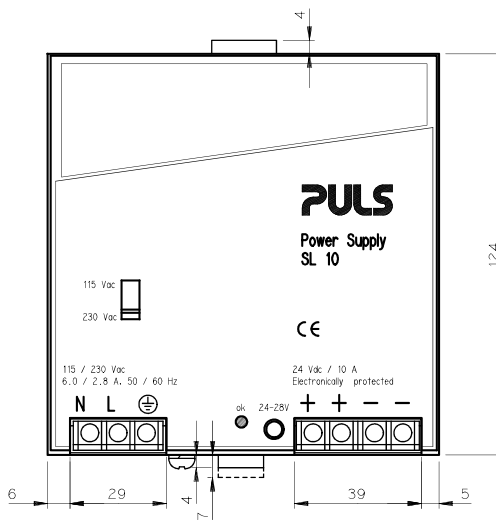
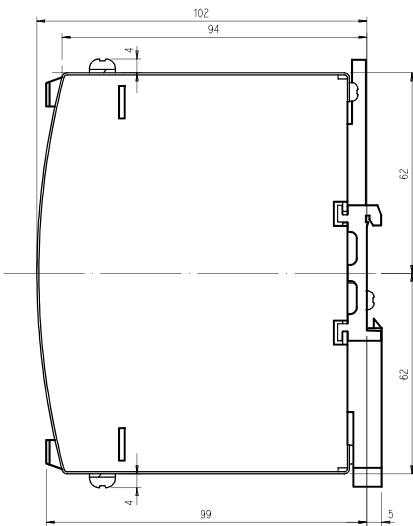

his 'mechanics data sheet' exclusively deals with the mechanical properties of the product. For further information (especially concerning electrical properties), please refer to the generic data sheet of the SL2.5, SL5 and SL10 and to the basic data sheet „The SilverLine“ dealing with common features of all SilverLine units. This data sheet is subject to change without prior notice.

Your partner in power supply:



PULS GmbH
 Arabellastraße 15
 D-81925 München
 Tel.: +49 89 9278-0
 Fax: +49 89 9278-199
 www.puls-power.com