ISOLATED EVALUATION BOARD FOR THE Si3402B

1. Description

The Si3402B isolated evaluation board (Si3402BISO-EVB Rev 2) is a reference design for power supplies in Power over Ethernet (PoE) Powered Device (PD) applications. The Si3402B is described more completely in the data sheet and application notes. This document describes only the Si3402BISO-EVB evaluation board. An evaluation board demonstrating the non-isolated application is described in the Si3402B-EVB User's Guide.

2. Planning for Successful Designs

Skyworks Solutions strongly recommends the use of the schematic and layout databases provided with the evaluation boards as the starting point for your design. Use of external components other than those described and recommended in this document is generally discouraged. Refer to Table 2 on page 9 for more information on critical component specifications. Careful attention to the recommended layout guidelines is required to enable robust designs and full specification compliance. To help ensure design success, please submit your schematic and layout databases to the Power group for review and feedback.

3. Si3402B Board Interface

Ethernet data and power are applied to the board through the RJ-45 connector (J1). The board itself has no Ethernet data transmission functionality, but, as a convenience, the Ethernet transformer secondary is brought out to the test points. Power may be applied in the following ways:

- Connecting a dc source to Pins 1, 2 and 3, 6 of the Ethernet cable (either polarity).
- Connecting a dc source to Pins 4, 5 and 7, 8 of the Ethernet cable (either polarity).
- Using an IEEE 802.3-2015-compliant, PoE-capable PSE, such as Trendnet TPE-1020WS.

The Si3402BISO-EVB board schematics and layout are shown in Figures 1 through 6.

The dc output is at connectors J11(+) and J12(-). Boards are generally shipped configured to produce +5 V output voltage but can be configured for +3.3 V or other output voltages as shown in Table 2 on page 9. The preconfigured Class 3 signature also can be modified according to Table 3 on page 10. The D8–D15 Schottky-type diode bridge bypass is recommended only for higher power levels (Class 3 operation). For lower power levels, such as Class 1 and Class 2, the diodes can be removed. When the Si3402B is used in external diode bridge configuration, it requires at least one pair of the CTx and SPx pins to be connected to the PoE voltage input terminals (to the input of the external bridge).

The feedback loop compensation has been optimized for 3.3, 5, 9, and 12 V output as well as with standard and low ESR capacitors in the output filter section (Table 2 on page 9). The use of low ESR capacitors is recommended for lower output ripple, improved load transient response and low temperature (below 0 °C) operation.

Si3402BISO-EVB

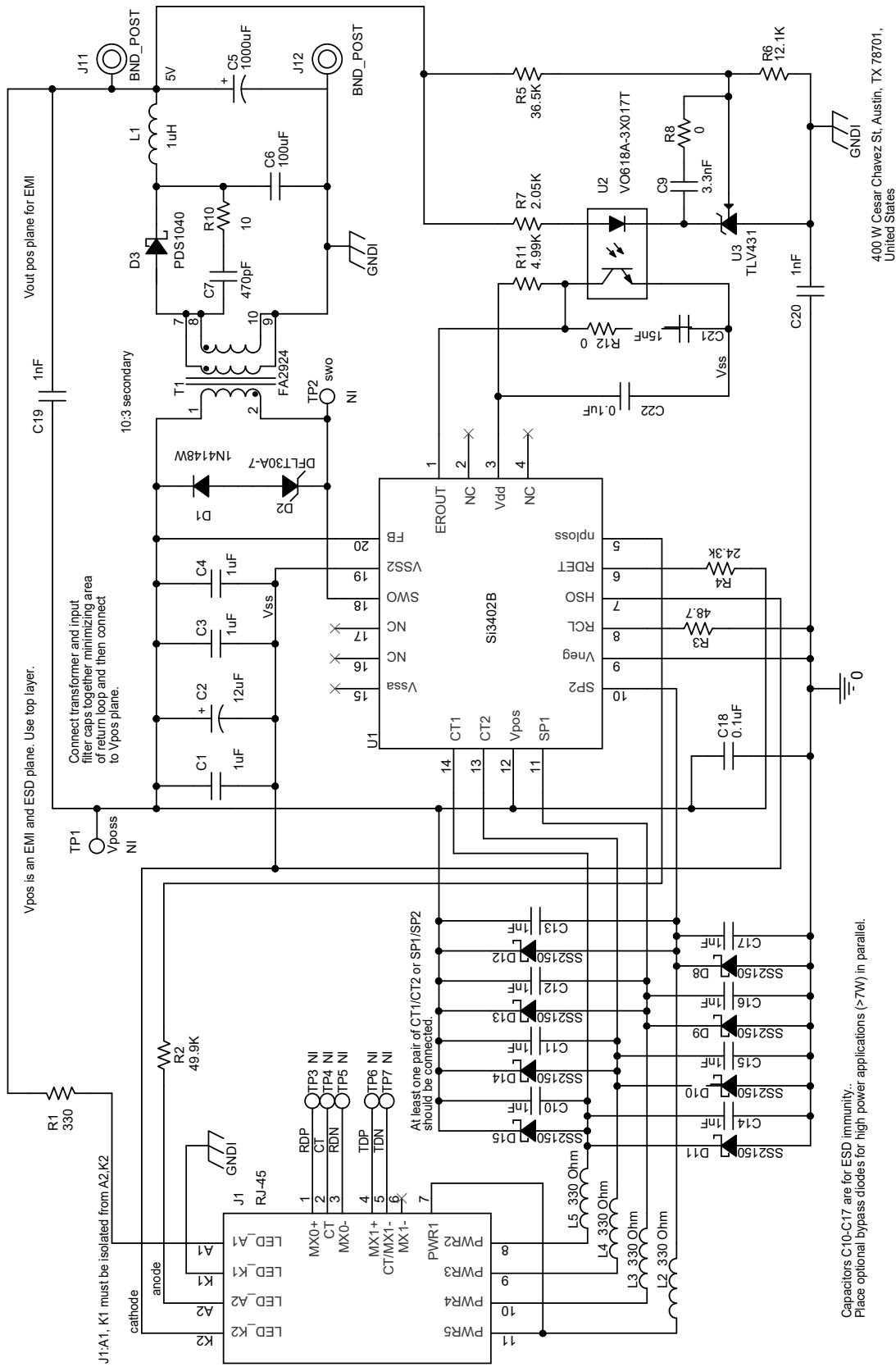

400 W Cesar Chavez St, Austin, TX 78701, United States

Figure 1. Si3402B Schematic—5 V, Class 3 PD

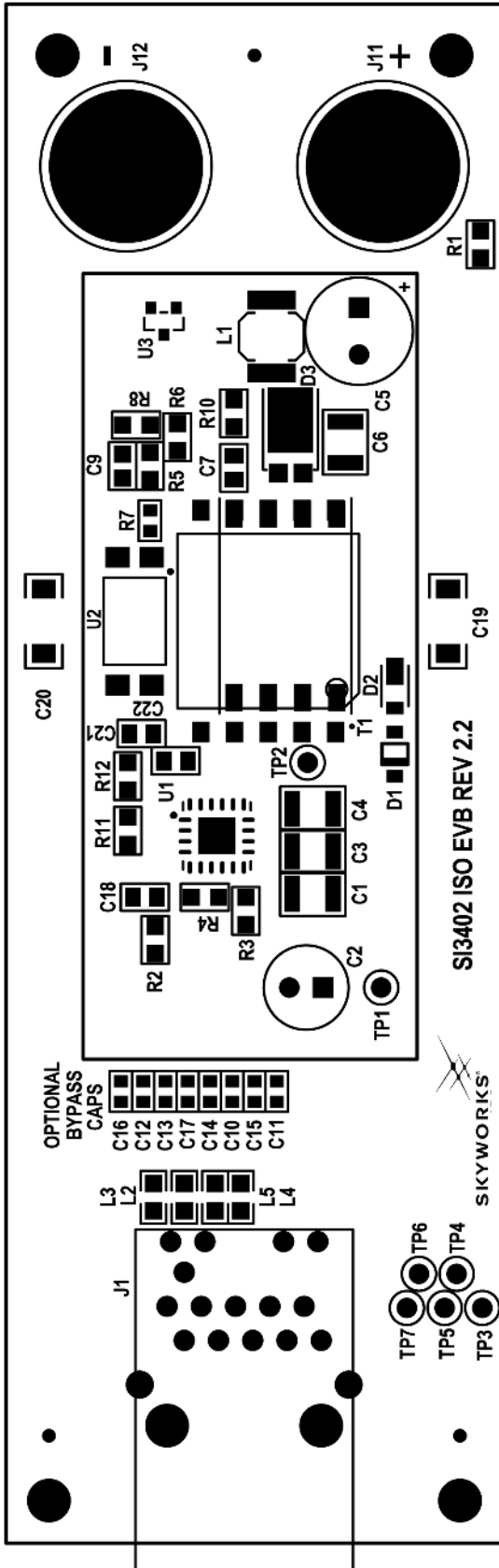

PRIMARY ASSEMBLY

PRIMARY SILKSCREEN

Figure 2. Si3402B Layout (Top Layer)

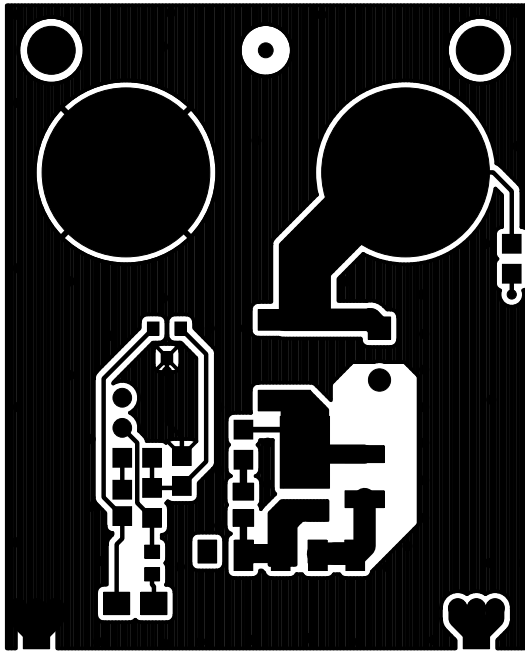

PRIMARY SIDE

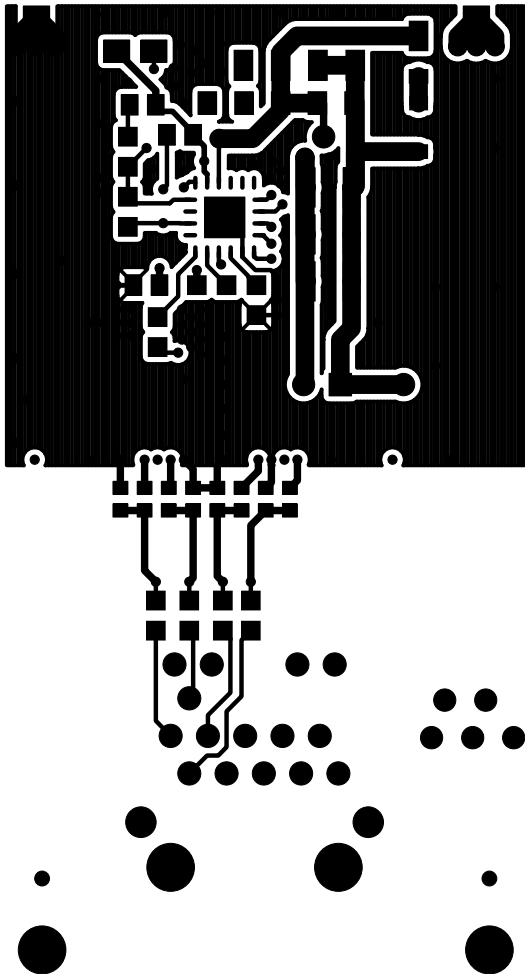
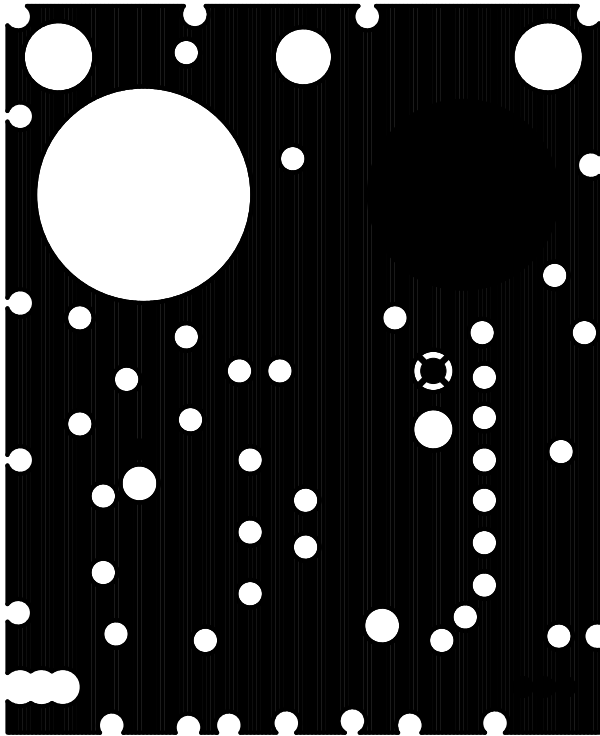

Figure 3. Primary Side (Layer 2)



INTERNAL 1

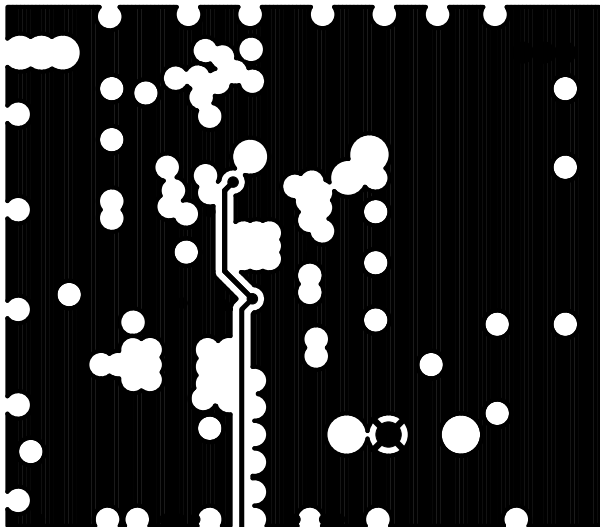
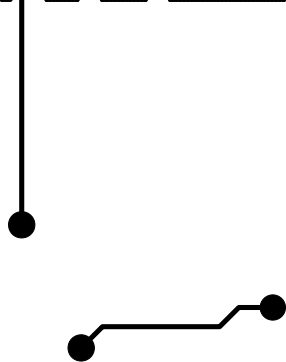
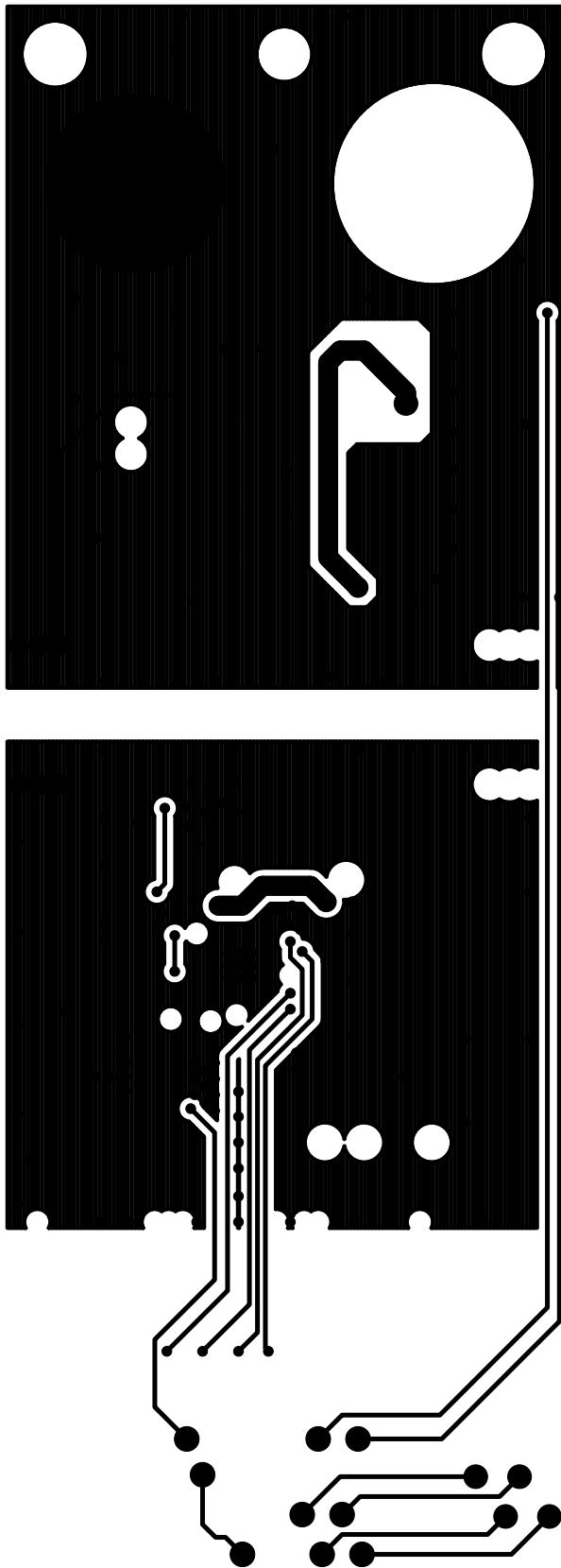

Figure 4. Internal 1 (Layer 3)





INTERNAL 2

Figure 5. Internal 2 (Layer 4)

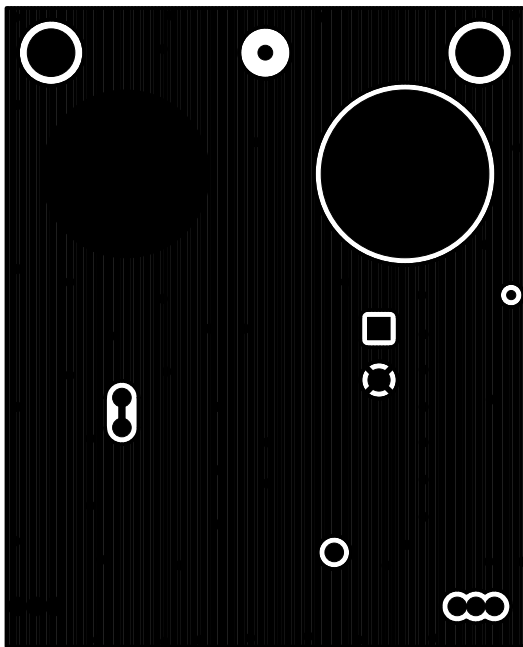

SECONDARY SIDE

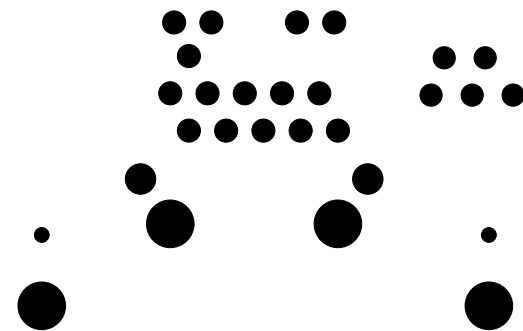
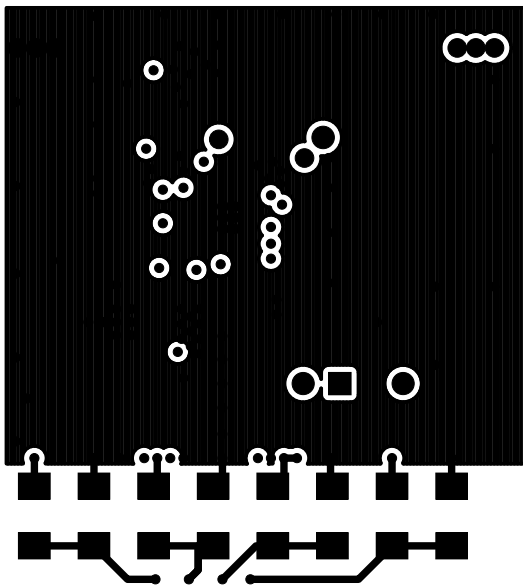

Figure 6. Secondary Side (Bottom Layer)

Si3402BISO-EVB

4. Bill of Materials

The following bill of materials is for a 5 V Class 3 design. For Class 1 and Class 2 designs, in addition to updating the classification resistor (R3), the external diode bridge (D8–D15) can be removed to reduce BOM costs. Tables 2 and 3 list changes to the bill of materials for other output voltages and classification levels. Refer to “AN956: Using the Si3402B PoE PD Controller in Isolated and Non-Isolated Designs” for more information.

Table 1. Si3402BISO-EVB Bill of Materials

Qty	Value	Ref	Rating	Voltage	Tol	Type	PCB Footprint	Mfr Part Number	Mfr
3	1 μ F	C1, C3, C4		100 V	$\pm 10\%$	X7R	C1210	C1210X7R101-105K	Venkel
1	12 μ F	C2		100 V	$\pm 20\%$	Alum_Elec	C2.5X6.3MM-RAD	EEUFC2A120	Panasonic
1	1000 μ F	C5		6.3 V	$\pm 20\%$	Alum_Elec	C3.5X8MM-RAD	ECA0JM102	Panasonic
1	100 μ F	C6		6.3 V	$\pm 10\%$	X5R	C1210	C1210X5R6R3-107K	Venkel
1	470 pF	C7		50 V	$\pm 10\%$	X7R	C0805	C0805X7R500-471K	Venkel
1	3.3 nF	C9		16 V	$\pm 10\%$	X7R	C0805	C0805X7R160-332K	Venkel
8	1 nF	C10, C11, C12, C13, C14, C15, C16, C17		100 V	$\pm 10\%$	X7R	C0603	C0603X7R101-102K	Venkel
1	0.1 μ F	C18		100 V	$\pm 10\%$	X7R	C0805	C0805X7R101-104K	Venkel
2	1 nF	C19, C20		3000 V	$\pm 10\%$	X7R	C1808	C1808X7R302-102K	Venkel
1	15 nF	C21		16 V	$\pm 10\%$	X7R	C0805	C0805X7R160-153K	Venkel
1	0.1 μ F	C22		16 V	$\pm 10\%$	X7R	C0805	C0805X7R160-104K	Venkel
1	1N4148W	D1	2 A	100 V		Fast	SOD123	1N4148W	Diodes Inc
1	DFLT30A-7	D2	4.65 A	30 V		Zener	POWERDI-123	DFLT30A-7	Diodes Inc.
1	PDS1040	D3	10 A	40 V		Schottky	POWERDI-5	PDS1040-13	Diodes Inc.
8	SS2150	D8, D9, D10, D11, D12, D13, D14, D15	2 A	150 V		Single	DO-214AC	SS2150-LTP	MCC
1	RJ-45	J1				Receptacle	RJ45-SI-52004	SI-52003-F	Bel
2	BND_POST	J11, J12	15 A			Banana	Banana-Jack	101	ABBATRON HH SMITH
1	1 μ H	L1	2.9 A		$\pm 20\%$	Shielded	IND-6.6X4.45MM	DO1608C-102ML_	Coilcraft
4	330 Ω	L2, L3, L4, L5	1500 mA			SMT	L0805	BLM21PG331SN1	MuRata
1	330 Ω	R1	1/10 W		$\pm 1\%$	ThickFilm	R0805	CR0805-10W-3300F	Venkel
1	49.9 k Ω	R2	1/10 W		$\pm 1\%$	ThickFilm	R0805	CR0805-10W-4992F	Venkel
1	48.7 Ω	R3	1/8 W		$\pm 1\%$	ThickFilm	R0805	CRCW080548R7FKTA	Vishay
1	24.3 k Ω	R4	1/8 W		$\pm 1\%$	ThickFilm	R0805	CRCW080524K3FKEA	Vishay
1	36.5 k Ω	R5	1/10 W		$\pm 1\%$	ThickFilm	R0805	CR0805-10W-3652F	Venkel
1	12.1 k Ω	R6	1/10 W		$\pm 1\%$	ThickFilm	R0805	CR0805-10W-1212F	Venkel
1	2.05 k Ω	R7	1/16 W		$\pm 1\%$	ThickFilm	R0603	CR0603-16W-2051F	Venkel
2	0 Ω	R8, R12	2 A			ThickFilm	R0805	CR0805-10W-000	Venkel
1	10 Ω	R10	1/10 W		$\pm 1\%$	ThickFilm	R0805	CR0805-10W-10R0F	Venkel
1	4.99 k Ω	R11	1/10 W		$\pm 1\%$	ThickFilm	R0805	CR0805-10W-4991F	Venkel
1	FA2924	T1					XFMR-FA2924	FA2924-AL	Coilcraft
1	Si3402B	U1		100		PD	QFN20N5X5P0.8	Si3402B	Skyworks Solutions
1	VO618A-3X017T	U2					SO4N10.16P2.54-AKEC	VO618A-3X017T	Vishay
1	TLV431	U3				Shunt	TLV431-DBZ	TLV431BCDBZR	TI
Not Installed Components									
7	Black	TP1, TP2, TP3, TP4, TP5, TP6, TP7				Loop	Testpoint	5001	Keystone

Table 2. Component Selection for other Output Voltages and Filter Types

3.3 V Output	Transformer* EP10 FA2671 EP13FA2924AL		Output Rectifier: PDS1040 Snubber: R10, C7 10 W, 470 pF		Reference Any TLV431	
	R5 R6	C6	C5	Panasonic	R7, R8, R12	C9,C21
Standard ESR Output Filter	24.3 kΩ 14.7 kΩ	100 μF X5R	1000 μF 6.3 V	ECA0JM102	500 Ω, 1.1 kΩ, 475 Ω	10 nF, 33 nF,
Low ESR Output Filter	24.3 kΩ 14.7 kΩ	100 μF X5R	560 μF 6.3 V	EEUFM0J561	324 Ω, 2 kΩ, 820 Ω	10 nF, 100 nF
5.0 V Output	Transformer* EP10 FA2671 EP13FA2924CL		Output Rectifier PDS1040 Snubber: R10, C7 10Ω, 470 pF		Reference Any TLV431	
	R5 R6	C6	C5	Panasonic	R7, R8, R12	C9, C21
Standard ESR Output Filter	36.5 kΩ 12.1 kΩ	100 μF X5R	1000 μF 6.3 V	ECA0JM102	2.05 kΩ, 0 Ω, 0 Ω	3.3nF, 15 nF
Low ESR Output Filter	36.5 kΩ 12.1 kΩ	100 μF X5R	560 μF 6.3 V	EEUFM0J561	2.05 kΩ, 0 Ω, 0 Ω	3.3nF, 33 nF
9.0 V Output	Transformer* EP10 FA2672 EP13FA2805CL		Output Rectifier: PDS5100 Snubber: R10, C7 20 Ω, 68 pF		Reference Higher voltage e.g., TLV431ASNT1G	
	R5 R6	C6	C5	Panasonic	R1,R7, R8, R12	C9,C21
Standard ESR Output Filter	66.5 kΩ 10.5 kΩ	22 μF X5R 16 V	470 μF 16 V	ECA1M471	1.3 kΩ, 3 kΩ, 0 Ω, 0 Ω	10 nF, 15 nF
Low ESR Output Filter	66.5 kΩ 10.5 kΩ	22 μF X5R 16 V	330 μF 16 V	EEUFM1C331	3 kΩ, 0 Ω, 0 Ω	10 nF, 15 nF
12.0 V Output	Transformer* EP10 FA2672 EP13FA2805CL		Output rectifier: PDS5100 Snubber: R10, C7 20 Ω, 68 pF		Reference Higher Voltage e.g., TLV431ASNT1G	
	R5 R6	C6	C5	Panasonic	R1,R7, R8, R12	C9,C21
Standard ESR Output Filter	88.7 kΩ 10.2 kΩ	22 μF X5R 16 V	470 μF 16 V	ECA1M471	1.3 kΩ, 3 kΩ, 0 Ω, 0 Ω	10 nF, 15 nF
Low ESR Output Filter	88.7 kΩ 10.2 kΩ	22 μF X5R 16 V	330 μF 16 V	EEUFM1C331	1.3 kΩ, 3 kΩ, 0 Ω, 0 Ω	10 nF, 15 nF
*Note: Coilcraft part number. EP13 core is recommended for >10 W output power.						

Table 3. Component Selection for Different Classification Levels

Class	R3 (1%)
0	Open
1	140
2	75
3	45.3

APPENDIX—Si3402BISO DESIGN AND LAYOUT CHECKLIST

Introduction

Although all four EVB designs are preconfigured as Class 3 PDs with 5 V outputs, the schematics and layouts can easily be adapted to meet a wide variety of common output voltages and power levels.

The complete EVB design databases for the standard 5 V/Class 3 configuration are included in the EVB kit and can also be requested through Skyworks Solutions customer support at <https://www.skyworksinc.com/support-ia> under the “Documentation” link. Skyworks Solutions strongly recommends using these EVB schematics and layout files as a starting point to ensure robust performance and to help avoid common mistakes in the schematic capture and PCB layout processes.

Following are recommended design checklists that can assist in trouble-free development of robust PD designs: Refer also to the Si3402B data sheet and AN956 when using the checklists below.

1. Design Planning Checklist:

- a. Skyworks Solutions strongly recommends using the EVB schematics and layout files as a starting point as you begin integrating the Si3402B into your system design process.
- b. Determine your load’s power requirements (i.e., V_{OUT} and I_{OUT} consumed by the PD, including the typical expected transient surge conditions). In general, to achieve the highest overall efficiency performance of the Si3402, choose the highest voltage used in your PD and then post regulate to the lower supply rails, if necessary.
- c. If your PD design consumes >7 W, make sure you bypass the Si3402’s on-chip diode bridges with external Schottky diode bridges or discrete Schottky diodes. Bypassing the Si3402’s on-chip diode bridges with external bridges or discrete diodes is required to help spread the heat generated in designs dissipating ≥ 7 W.
- d. Based on your required PD power level, select the appropriate class resistor value by referring to Table 3 of AN956. This sets the Rclass resistor (R3 in Figure 1 on page 2).
- e. The feedback loop stability has been checked over the entire load range for the specific component choices in Table 1. Low ESR filter capacitors will give better load transient response and lower output ripple so they are generally preferred. For the standard ESR capacitor, the ESR increase at very low temperatures may cause a loop stability issue. A typical evaluation board has been shown to exhibit instability under very heavy loads at -20 °C. Due to self-heating, this condition is not a great concern. However, using a low ESR filter capacitor solves this problem (but requires some recompensation of the feedback loop). Skyworks Solutions recommends against component substitution in the filtering and feedback path as this may result in unstable operation. Also, use care in situations that have additional capacitive loading as this will also affect loop stability.

1. General Design Checklist Items:

- a. ESD caps (C10–C17 in Figure 1) are strongly recommended for designs where system-level ESD (IEC6100-4-2) must provide >15 kV tolerance.
- b. If your design uses an AUX supply, make sure to include a $3\ \Omega$ surge limiting resistor in series with the AUX supply for hot insertion. Refer to AN956 when AUX supply is 48 V.
- c. Skyworks Solutions strongly recommends the inclusion of a minimum load (250 mW) to avoid switcher pulsing when no load is present, and to avoid false disconnection when less than 10 mA is drawn from the PSE. If your load is not at least 250 mW, add a resistor load to dissipate at least 250 mW.
- d. If using PLOSS function, make sure it’s properly terminated for connection in your PD subsystem. If PLOSS is not needed, leave this pin floating.

Si3402BISO-EVB

1. Layout Guidelines:

- a. Make sure the VNEG pin of the Si3402B is connected to the backside of the QFN package with an adequate thermal plane, as noted in the data sheet and AN956.
- b. Keep the trace length from connecting to SWO and retuning to Vss1 and Vss2 as short as possible. Make all of the power (high current) traces as short, direct, and thick as possible. It is a good practice on a standard PCB board to make the traces an absolute minimum of 15 mils (0.381 mm) per Ampere.
- c. Usually one standard via handles 200 mA of current. If the trace will need to conduct a significant amount of current from one plane to the other use multiple vias.
- d. Keep the circular area of the loop from the Switcher FET output to the inductor or transformer and returning from the input filter capacitors (C1–C4) to Vss2 as small a diameter as possible. Also, minimize the circular area of the loop from the output of the inductor or transformer to the Schottky diode and returning through the first stage output filter capacitor back to the inductor or transformer as small as possible. If possible, keep the direction of current flow in these two loops the same.
- e. Connect the sense points to the output terminals directly to avoid load regulation issues related to IR drops in the PCB traces. The sense points are the output side of R5 and Pin 3 of TLV431.
- f. Keep the feedback and loop stability components as far from the transformer/inductor and noisy power traces as possible.
- g. If the outputs have a ground plane or positive output plane, do not connect the high current carrying components and the filter capacitors through the plane. Connect them together and then connect to the plane at a single point.
- h. As a convenience in layout, please note that the IC is symmetrical with respect to CT1, CT2, SP1 and SP2. These leads can be interchanged. At least one pair of CT1/CT2 or SP1/SP2 should be connected.

To help ensure first pass success, please submit your schematics and layout files to the Power group for review. Other technical questions may be submitted as well.

DOCUMENT CHANGE LIST

Revision 1.1 to Revision 1.2

- Initial release of Si3402BISO-EVB User's Guide, modified from Si3402-ISO-EVB User's Guide Revision 1.1.

Revision 1.2 to Revision 1.3

- Updated layers in Figures 2 through 6.



SKYWORKS®

**Connecting Everyone
and Everything,
All the Time**



Portfolio

www.skyworksinc.com

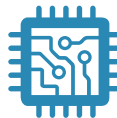

Quality

www.skyworksinc.com/quality



Support & Resources

www.skyworksinc.com/support

Copyright © 2021 Skyworks Solutions, Inc. All Rights Reserved.

Information in this document is provided in connection with Skyworks Solutions, Inc. ("Skyworks") products or services. These materials, including the information contained herein, are provided by Skyworks as a service to its customers and may be used for informational purposes only by the customer. Skyworks assumes no responsibility for errors or omissions in these materials or the information contained herein. Skyworks may change its documentation, products, services, specifications or product descriptions at any time, without notice. Skyworks makes no commitment to update the materials or information and shall have no responsibility whatsoever for conflicts, incompatibilities, or other difficulties arising from any future changes.

No license, whether express, implied, by estoppel or otherwise, is granted to any intellectual property rights by this document. Skyworks assumes no liability for any materials, products or information provided hereunder, including the sale, distribution, reproduction or use of Skyworks products, information or materials, except as may be provided in Skyworks' Terms and Conditions of Sale.

THE MATERIALS, PRODUCTS AND INFORMATION ARE PROVIDED "AS IS" WITHOUT WARRANTY OF ANY KIND, WHETHER EXPRESS, IMPLIED, STATUTORY, OR OTHERWISE, INCLUDING FITNESS FOR A PARTICULAR PURPOSE OR USE, MERCHANTABILITY, PERFORMANCE, QUALITY OR NON-INFRINGEMENT OF ANY INTELLECTUAL PROPERTY RIGHT; ALL SUCH WARRANTIES ARE HEREBY EXPRESSLY DISCLAIMED. SKYWORKS DOES NOT WARRANT THE ACCURACY OR COMPLETENESS OF THE INFORMATION, TEXT, GRAPHICS OR OTHER ITEMS CONTAINED WITHIN THESE MATERIALS. SKYWORKS SHALL NOT BE LIABLE FOR ANY DAMAGES, INCLUDING BUT NOT LIMITED TO ANY SPECIAL, INDIRECT, INCIDENTAL, STATUTORY, OR CONSEQUENTIAL DAMAGES, INCLUDING WITHOUT LIMITATION, LOST REVENUES OR LOST PROFITS THAT MAY RESULT FROM THE USE OF THE MATERIALS OR INFORMATION, WHETHER OR NOT THE RECIPIENT OF MATERIALS HAS BEEN ADVISED OF THE POSSIBILITY OF SUCH DAMAGE.

Skyworks products are not intended for use in medical, lifesaving or life-sustaining applications, or other equipment in which the failure of the Skyworks products could lead to personal injury, death, physical or environmental damage. Skyworks customers using or selling Skyworks products for use in such applications do so at their own risk and agree to fully indemnify Skyworks for any damages resulting from such improper use or sale.

Customers are responsible for their products and applications using Skyworks products, which may deviate from published specifications as a result of design defects, errors, or operation of products outside of published parameters or design specifications. Customers should include design and operating safeguards to minimize these and other risks. Skyworks assumes no liability for applications assistance, customer product design, or damage to any equipment resulting from the use of Skyworks products outside of Skyworks' published specifications or parameters.

Skyworks, the Skyworks symbol, Sky5®, SkyOne®, SkyBlue™, Skyworks Green™, Clockbuilder®, DSPLL®, ISOModem®, ProSLIC®, and SiPHY® are trademarks or registered trademarks of Skyworks Solutions, Inc. or its subsidiaries in the United States and other countries. Third-party brands and names are for identification purposes only and are the property of their respective owners. Additional information, including relevant terms and conditions, posted at www.skyworksinc.com, are incorporated by reference.

Skyworks Solutions, Inc. | Nasdaq: SWKS | sales@skyworksinc.com | www.skyworksinc.com

USA: 781-376-3000 | Asia: 886-2-2735 0399 | Europe: 33 (0)1 43548540 |