

T2 Terminator Tooling

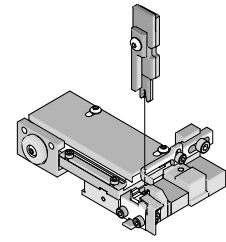

Application Tooling Specification Sheet



Order No. 63912-2100

FEATURES

- It is ideally suited for mid-volume bench operations
- This terminator can be installed in the TM42 and the TM40 press or Base Unit adapter for 3BF press
- Quick punch removal with the push of a button for fast and easy tooling change
- Track adjustment capabilities in the T2 Terminators for improved control of the bell mouth size and cutoff tab length
- T2 Terminator has standardized tooling with the Molex FineAdjust Applicator which will reduce your inventory requirements

SCOPE

Products: 3.50 (.138") Wire-to-Wire Connector, Crimp Pin, 18-24 AWG.

Terminal Series No.	Terminal Order No.	Wire Size		Insulation Diameter				Strip Length	
		AWG	mm ²	IPC/WHMA-A60 (1)		Terminal (2)		mm	In.
				mm	In.	mm	In.		
50419	50419-9001	18	0.87	1.65-2.20	.065-.087	1.40-3.00	.055-.118	3.0-3.5	.118-.138
		20	0.50						
		22	0.35						
		24	0.20						

(1) To achieve optimum IPC-A620 Class 2 insulation crimps, use this insulation OD.
 (2) Overall insulation OD specification for terminal.
 Terminator 63912-2100 should be used for insulation OD 1.40-2.20mm (UL1007 or equivalent)
 Terminator 63912-2200 should be used for insulation OD 2.20-3.00mm (UL1015 or equivalent)

DEFINITION OF TERMS

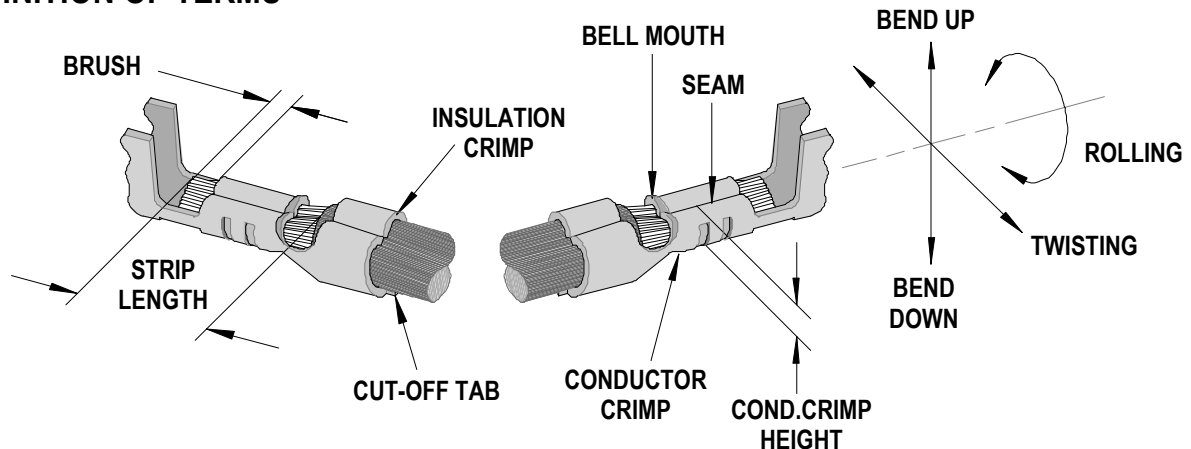

The above terminal drawing is a generic terminal representation. It is not an image of any terminal listed in the scope.

CRIMP SPECIFICATION

Terminal Series No.	Bell mouth		Cut-off Tab Maximum		Conductor Brush	
	mm	In.	mm	In.	mm	In.
50419	0.05-0.60	.002-.024	0.30	.012	0-1.0	0.0-.039

Terminal Series No.	Bend up	Bend down	Twist	Roll	Punch Width (Ref)				Seam Seam shall not be open and no wire allowed out of the crimping area
	Degree		Degree		Conductor		Insulation		
	mm	In	mm	In	mm	In	mm	In	
50419	4	3	3	8	1.70	.067	2.40	.095	

After crimping, the crimp profiles should measure the following:

Terminal Series No.	Wire Size		Conductor				Insulation				Pull Force Minimum	
			Crimp Height		Crimp Width (Ref)		Crimp Height (Ref)		Crimp Width (Ref)			
	AWG	mm ²	mm	In.	mm	In.	mm	In.	mm	In.	N	Lb.
50419	18	0.87	1.18-1.28	.046-.050	1.70	.067	2.90	.114	2.55	.100	88.2	19.8
	20	0.50	1.05-1.15	.041-.045	1.70	.067	2.80	.110	2.55	.100	58.8	13.2
	22	0.35	0.95-1.04	.037-.041	1.70	.067	2.70	.106	2.55	.100	39.2	8.8
	24	0.20	0.90-0.99	.035-.039	1.70	.067	2.70	.106	2.55	.100	29.4	6.6

T Tool Qualification Notes:

1. Pull Force should be measured with no influence from the insulation crimp.
2. The above specifications are guidelines to an optimum crimp.

PARTS LIST

T2 Terminator 63912-2100				
Item	Order No	Engineering No.	Description	Quantity
Perishable Tooling				
	63912-2170	63912-2170	Tool Kit (All "Y" Items)	REF
1	63457-0082	63457-0082	Conductor Punch	1 Y
2	63445-1741	63445-1741	Conductor Anvil	1 Y
3	63454-0129	63454-0129	Insulation Punch	1 Y
4	63445-2471	63445-2471	Insulation Anvil	1 Y
5	63443-0002	63443-0002	Front Cut-Off Plunger	1 Y
6	63443-0012	63443-0012	Front Plunger Retainer	1 Y
Other Components				
7	11-17-0022	1739-21	Hold Down Spring	1
8	11-18-4083	60707-8	Feed Guide	1
9	11-24-1067	4996-4	Cut-off Plunger Spring	1
10	63443-0009	63443-0009	Front Scrap Chute	1
11	63443-0024	63443-0024	Key	1
12	63443-0085	63443-0085	Wire Stop L-Bracket	1
13	63443-0090	63443-0090	Wire Stop	1
14	63443-0093	63443-0093	Shank	1
15	63443-1720	63443-1720	19.00mm Height Spacer	1
16	63443-2216	63443-2216	16.00mm Spacer	1
17	63443-2301	63443-2301	3.05mm Spacer	1
18	63443-3101	63443-3101	Front Plunger Striker	1
19	63443-6010	63443-6010	Rear Cover	1
20	63443-7112	63443-7112	Terminal Hold Down	1
Frame				
21	63800-8500	63800-8500	T2 Terminator	1
Hardware				
22	N/A	N/A	M3 by 6 Long FHCS	1**
23	N/A	N/A	M3 by 6 Long SHCS	2**
24	N/A	N/A	M3 by 8 Long SHCS	1**
25	N/A	N/A	M4 by 6 Long SHCS	2**
26	N/A	N/A	M4 by 12 Long BHCS	2**
27	N/A	N/A	M4 by 14 Long SHCS	2**
28	N/A	N/A	M4 by 50 Long SHCS	2**
29	N/A	N/A	M5 by 12 Long SHCS	1**
30	N/A	N/A	#10-32 by 3/8" Long BHCS	1**

** Available from an industrial supply company such as MSC (1-800-645-7270).

Assembly Drawing

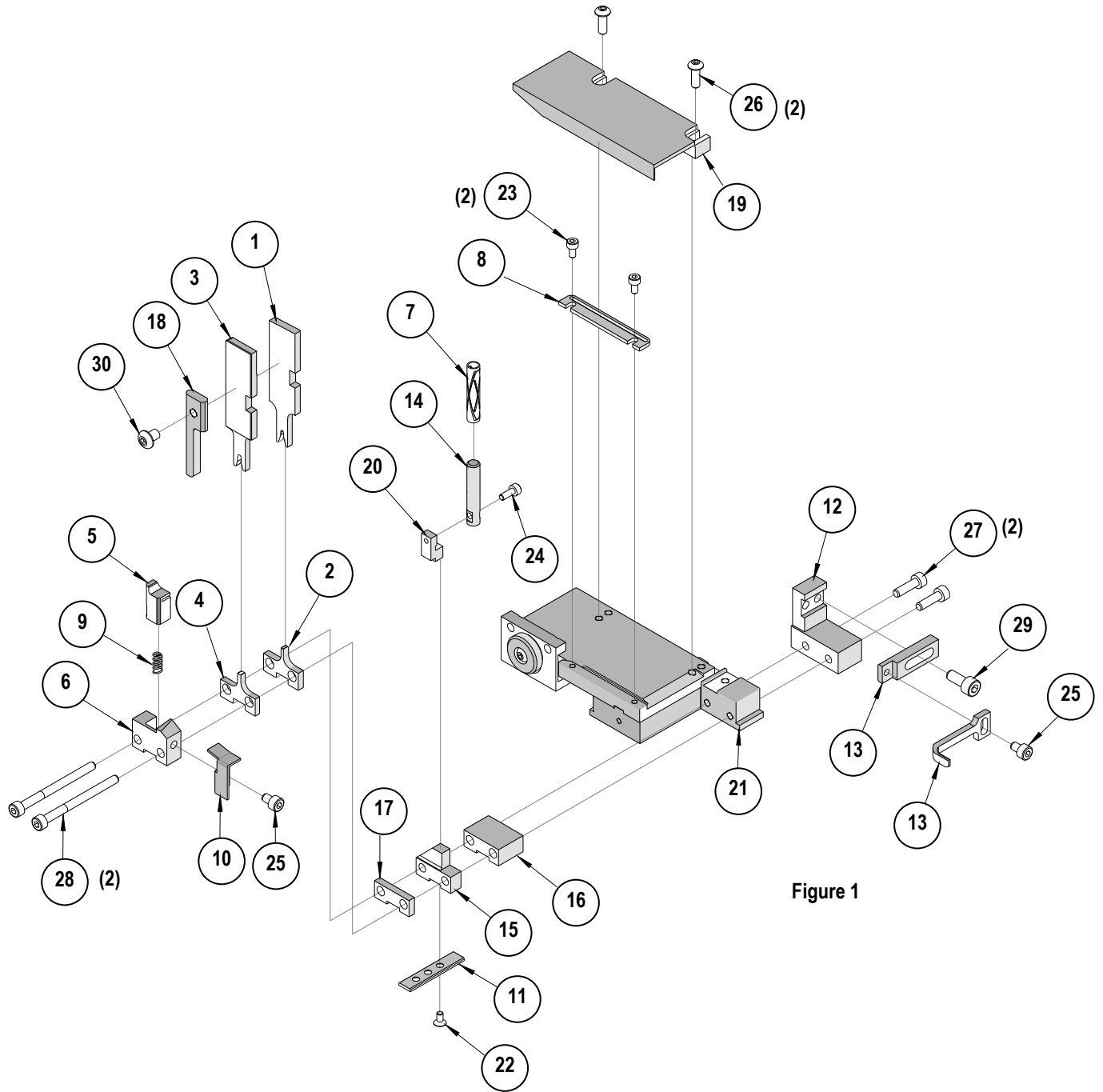

Figure 1

NOTES

Depending on the press vintage a feed finger assembly is supplied with the T2 Terminator.

1. To remove the existing feed finger assembly loosens the M4 x 10 mm set screw in the feed lever.
2. Select T2 Feed finger assembly from Terminator box.
3. Insert a screwdriver into the slot behind the feed lever and force the feed arm spring to the right.
4. Slide the T2 feed finger shaft for TM42 (11-40-5307) or (11-40-0123) for TM40 /Base Unit into the feed lever and to the left of the feed arm spring.
5. Release the feed arm spring.
6. Position feed finger for selected product. (Refer to Figure 5.1 in the T2 Manual).

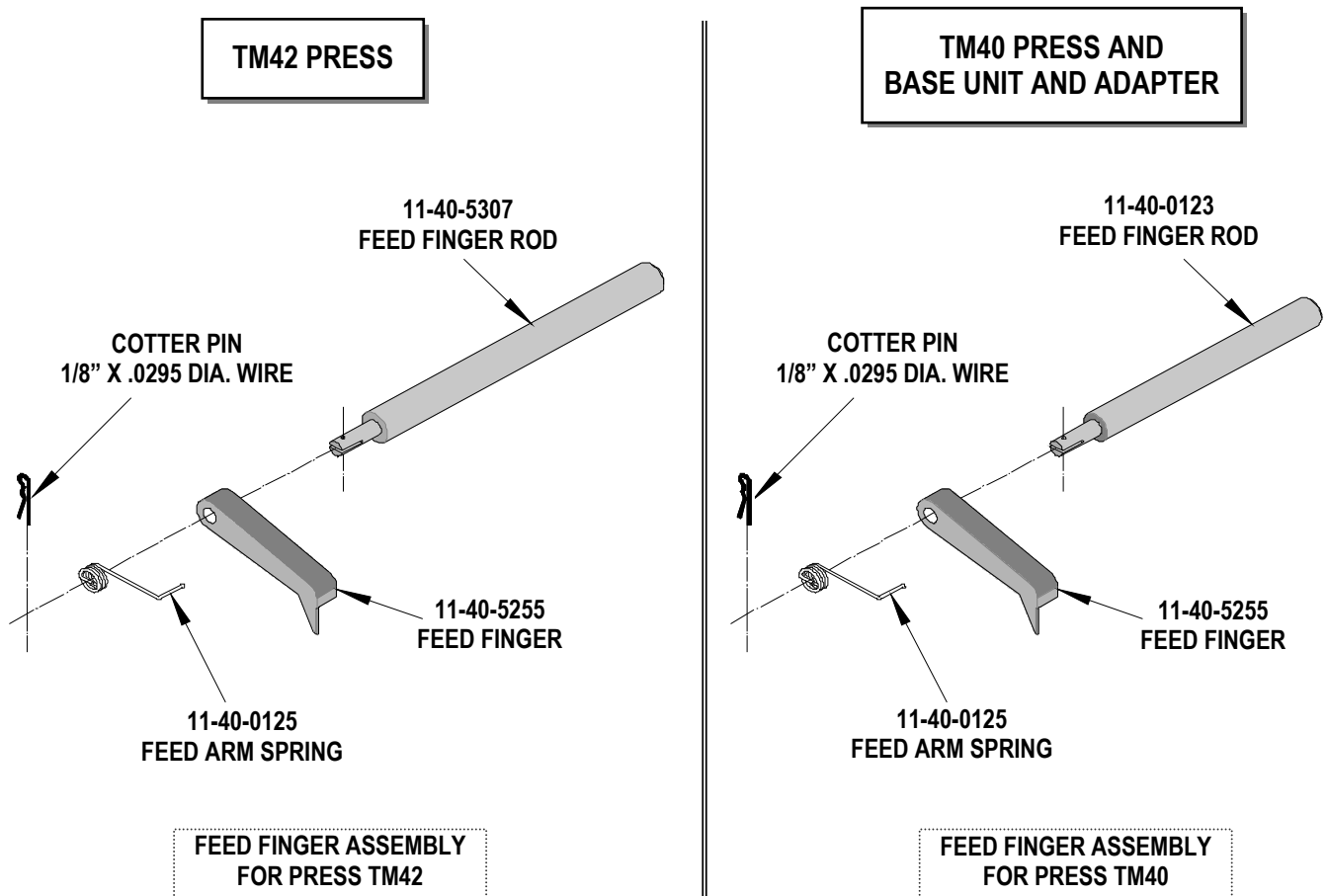

Figure 2

NOTES

1. Molex recommends an extra perishable tooling kit be maintained at your facility.
2. Verify tooling alignment by manually cycling the press before crimping under power. Check that all screws are tight.
3. Slugs, Terminals, Dirt and Oil should be kept clear of work area.
4. This Terminator should be only used in a Molex TM42, TM40, or 3BF Press with a Base Unit adaptor.
5. Wear safety glasses at all times.
6. For recommended maintenance refer to the TM40, TM42 Manual.

CAUTION: To prevent injury never operate this Terminator without the guards supplied with the press in place. Reference the TM42 press manufacturer's instruction manual.

CAUTION: Molex crimp specifications are valid only when used with Molex terminals, applicators and tooling.

<http://www.molex.com>