

DESCRIPTION

This demonstration board implements the IrDA® standards for infrared data communications. It is a complete transmitter/receiver for use in SIR, FIR and 4PPM infrared data links. The LT®1328 is a photodiode receiver that supports IrDA data rates up to 4Mbps, as well as other modulation methods such as Sharp-ASK and TV remote control. This board can be configured for IrDA-SIR (Infrared Data Association Serial Infrared), IrDA-FIR (Infrared Data Association Fast Infrared) and 4PPM (4MHz pulse-position modulation).

The LT1328, in the SO-8 and MSOP packages, contains all the necessary circuitry to convert current pulses from an external photodiode to a digital TTL output, while rejecting unwanted lower frequency interference. The LT1328 requires only six external components to make an IrDA compatible receiver. Figure 1 is a block diagram of the LT1328. The preamp converts the photodiode current into a voltage that trips the comparator. The internal servo action suppresses only frequencies below the R_{gm}/C_{FILT} pole. This highpass filtering attenuates interfering signals, such as sunlight or incandescent and fluorescent lamps, and is selectable at Pin 7 for low or high data rates. The upper frequency limit for the servo is set by an external capacitor C4. The pole is found by the formula $f(\text{Hz}) = 25[1/(2\pi \cdot 60k \cdot C4)]$; a 330pF capacitor for C4 will pass signals above 200kHz (FIR and 4PPM). To lower the passband for SIR, move the jumper on the demo board from FIR, 4PPM to SIR. This takes the MODE pin (Pin 7) from ground to V_{CC} , which switches C1 (on

Pin 3) in parallel with C4. The required filtering for V_{BIAS} (Pin 8) is provided by C6, a 1000pF cap to ground. The DATA pin (Pin 5) is the output of the comparator. The quiescent, no signal state is a TTL HIGH; a TTL LOW occurs when the photodiode receives light. Power requirements for the LT1328 are minimal: a single 5V supply and 2mA of quiescent current. The LT1328's ease of use and flexibility make it an ideal solution for numerous other photodiode receiver applications. The LT1328 is available in the 8-pin SO and the tiny MSOP package for size-critical applications.

An IrDA transmitter is also provided on the demo board. Figure 2 shows the LED driver circuit and the LT1328 receiver. The LED transmits light when the transmit input pin on the demo board is high (5V), and is off when the Transmit Input is low (0V). The receiver output is the DATA pin on the demo board (which is Pin 5 on the LT1328). The Data pin is high for no received light and a TTL LOW for a light pulse. To switch from SIR to the faster data rates, a jumper is provided. Remote switching can be accomplished by removing the jumper and accessing the MODE pin: TTL HIGH for SIR and TTL LOW for faster data rates.

Actual transmit and receive waveforms can be seen in Figures 3, 4 and 5 for SIR, FIR and 4PPM, respectively. The lower waveform in each photo is the transmit input to the demo board. The upper waveform is the demo board DATA pin (Pin 5 of the LT1328).

LT, LTC and LT are registered trademarks of Linear Technology Corporation.
 IrDA is a registered trademark of the Infrared Data Association.

BOARD PHOTO



PACKAGE AND SCHEMATIC DIAGRAMS

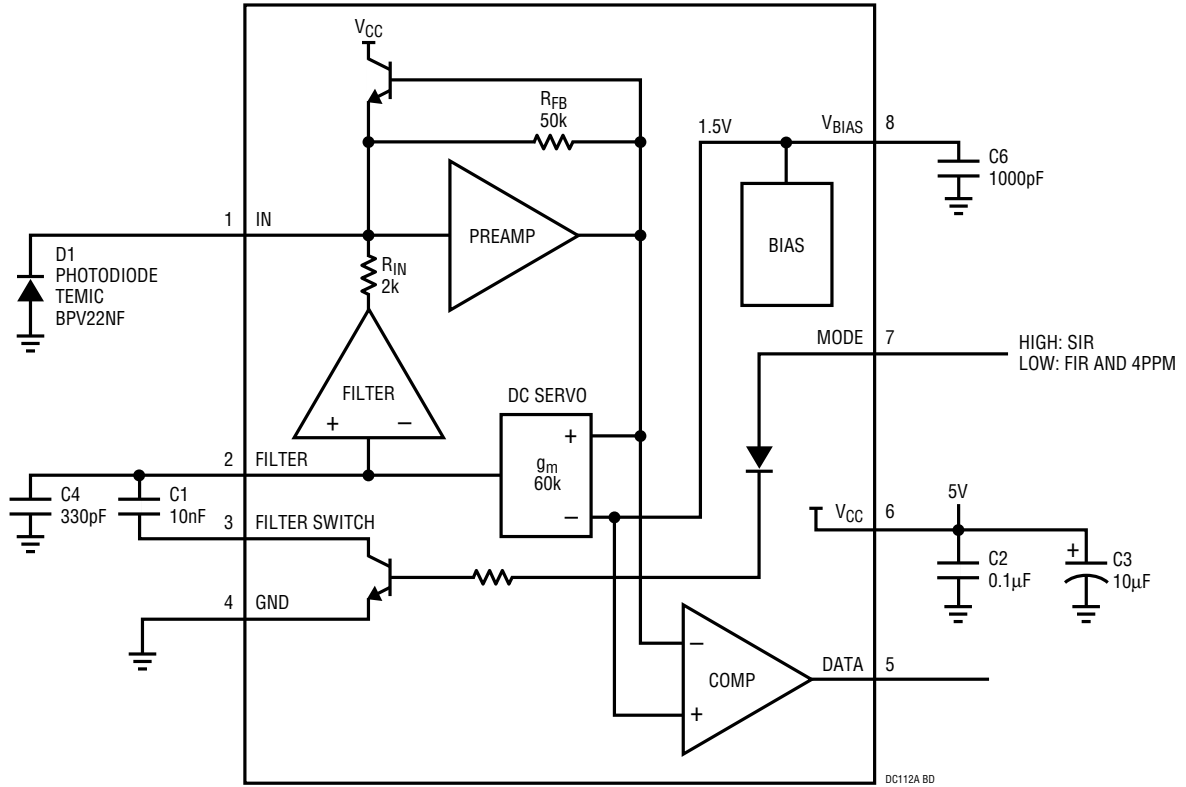

Figure 1. LT1328 Block Diagram

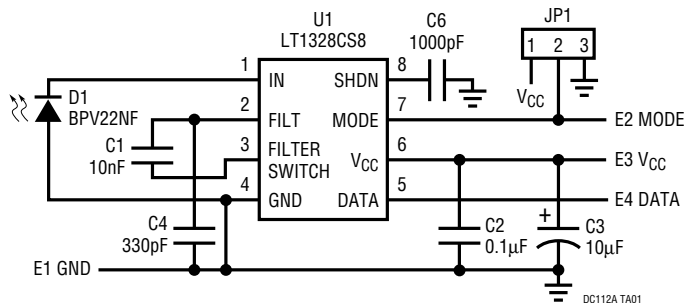
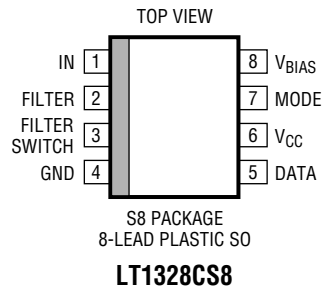
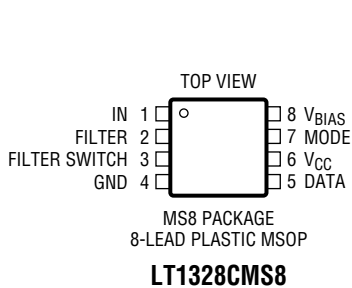

Figure 2a. IrDA Receiver

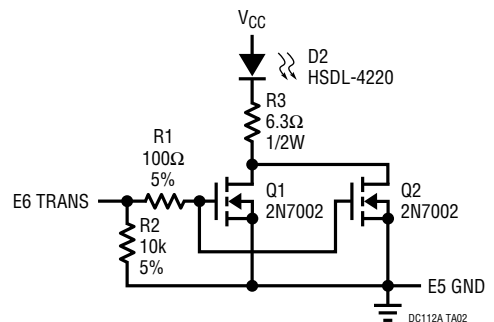

Figure 2b. IrDA Transmitter

PARTS LIST

| REFERENCE DESIGNATOR | QUANTITY | PART NUMBER | DESCRIPTION | VENDOR | TELEPHONE |
|----------------------|----------|----------------|---------------------------------------|-----------------|----------------|
| C1 | 1 | 12065C103KATMA | 0.01 μ F 50V 20% X7R Capacitor | AVX | (803) 946-0362 |
| C2 | 1 | 12065C104KATMA | 0.1 μ F 50V 10% X7R Capacitor | AVX | (803) 946-0362 |
| C3 | 1 | TAJC106K016R | 10 μ F 16V 10% Tantalum Capacitor | AVX | (207) 282-5111 |
| C4 | 1 | 1206A331KATMA | 330pF 50V 10% NPO Capacitor | AVX | (803) 946-0362 |
| C6 | 1 | 12065C102KATMA | 1000pF 50V 10% X7R Capacitor | AVX | (803) 946-0362 |
| D1 | 1 | BPV22NF | Diode | Temic | (408) 970-5700 |
| D2 | 1 | HSDL-4220 | LED | Hewlett Packard | (800) 235-0312 |
| E1 to E6 | 6 | 1502-2 | Turret | Keystone | (718) 956-8900 |
| JP1 | 1 | 3801S-3-G1 | 3-Pin Header | COMM CON | (818) 301-4200 |
| Q1, Q2 | 2 | 2N7002LTA | Transistor | Zetex | (516) 543-7100 |
| R1 | 1 | CR32-101J-T | 100 Ω 5% Resistor | AVX | (803) 946-0524 |
| R2 | 1 | CR32-103J-T | 10k 5% Resistor | AVX | (803) 946-0524 |
| R3 | 1 | CRCW20106R8J | 6.8 Ω 1/2W 5% | Dale | (408) 985-5733 |
| U1 | 1 | LT1328CS8 | IC | LTC | (408) 432-1900 |
| XJP1 | 1 | CCIJ230-G | Shunt | COMM CON | (818) 301-4200 |

OPERATION

The most straightforward way of evaluating IR links with the LT1328 demo board is to have a separate LED transmitter, like that on DC112A, that can be placed a measured distance from the receiver. If a second board is not available, it is a simple matter to duplicate the transmitter design shown in the schematic diagram (Figure 2). The pulses to drive this transmitter can be obtained from a suitable pulse generator that has a TTL output or from the system that will use the IR link, if available. Use coax cable and place a suitable termination on the input of the transmitter board to ensure good pulse fidelity.

The onboard jumper must be set for the modulation desired. The position of this jumper is marked on the demo board. For example, for IrDA-SIR modulation, set the mode jumper to the SIR side.

Connect an oscilloscope to the appropriate output of the demonstration board and apply a 5V power source capable

of supplying greater than 25mA to the V_{CC} and either GND pin (both ground pins are common).

Set the transmitter close to the receiver (≈ 1 cm), input an appropriate modulation signal to the trans input pin and verify the basic operation of the receiver using the modulation photographs (Figures 3, 4 and 5) as a guide.

You can then test the receiver over the desired range, transmitter power, angle of incidence or other variables. It is helpful to set up a space for an optical range that is clear of obstacles, reflections and interference. Later, when the basic operation of the IR link is established, the receiver can be tested against any interference that the final system may encounter. For more sophisticated testing, a Bit Error Rate Test (BERT) set is usually required, as are the circuits to modulate and demodulate the digital signals.

OPERATION

IrDA-SIR

Because SIR systems transmit a pulse for a zero and nothing for a one (see Figure 3a), the two photographs demonstrating the SIR modulation show a sequence of zeros. In both photographs, the input data to the transmitter is shown on the bottom and the output of the IR receiver

is shown on the top. Note that the receiver output is a TTL LOW for a transmitted light pulse. The two photos, Figures 3b and 3c, show received data at 1 meter and 1cm. There is not much difference at distances in between.

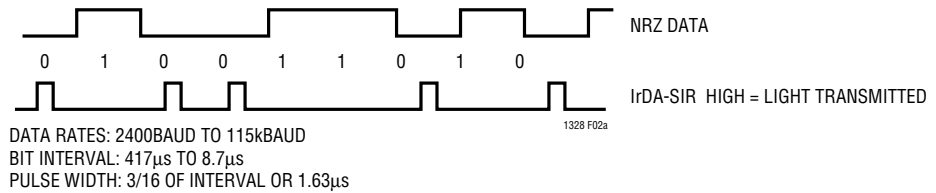

3a

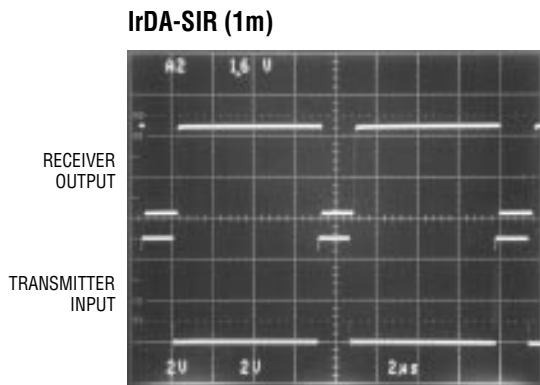

3b

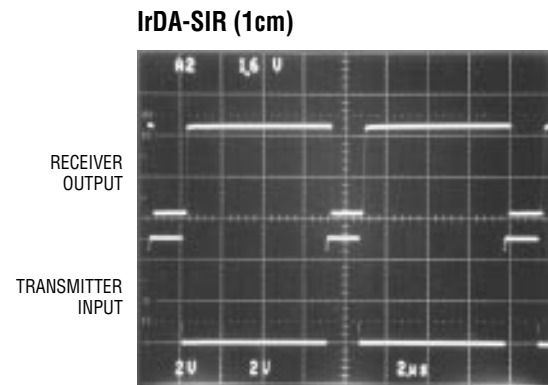

3c

Figure 3. IrDA-SIR Modulation

OPERATION

IrDA-FIR

With the exception of data rate and pulse width, FIR is very similar to SIR (see Figure 4a). The same precautions about interference from the other output apply to FIR and SIR. The first FIR photo, Figure 4b, shows the receiver at a

range of 1 meter. The second photo, Figure 4c, shows the receiver 1cm from the transmitter. Again, a detected light pulse will make the receiver switch to a TTL LOW state.

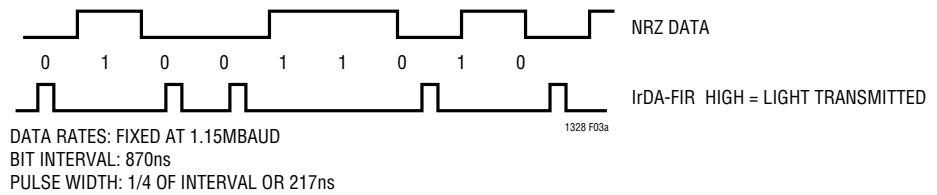

4a

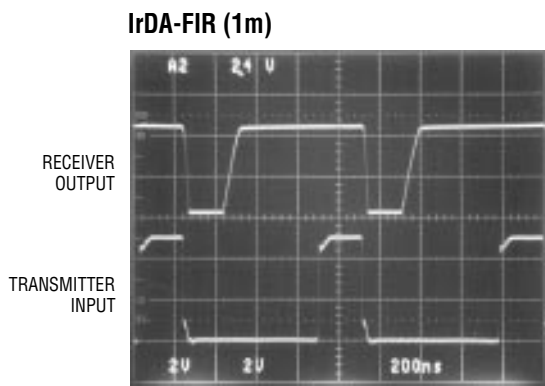

4b

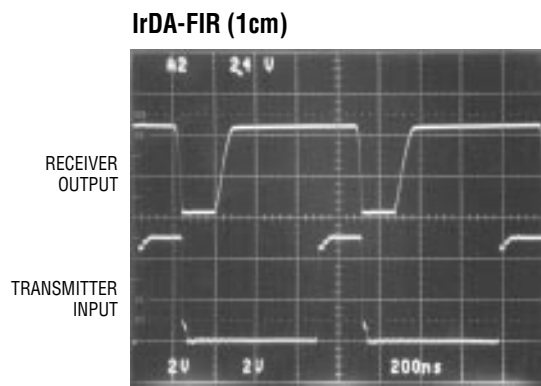

4c

Figure 4. IrDA-FIR Modulation

OPERATION

IrDA-4PPM

4Mbps pulse position modulation positions one pulse, 125ns wide in one of four data windows for every data bit pair. The four data windows make up a bit interval of 500ns (Figure 5a). By varying the distance from the demo board

to the transmitter, the LT1328's output can be evaluated. The first photo, Figure 5b, is when the receiver is 1 meter from the transmitter. The second photo shows the 1cm response.

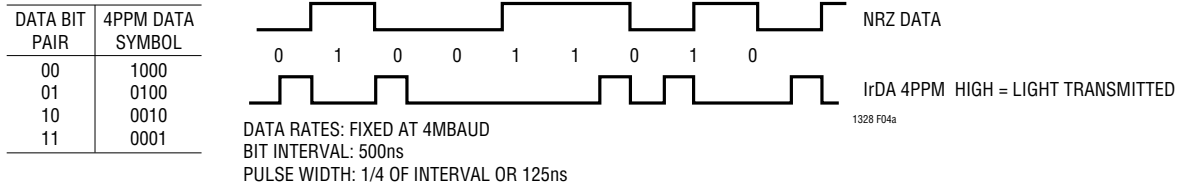

5a

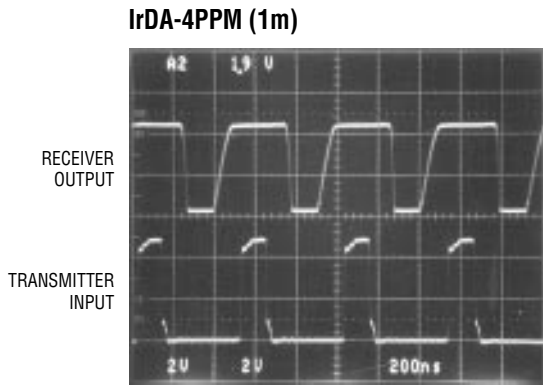

5b

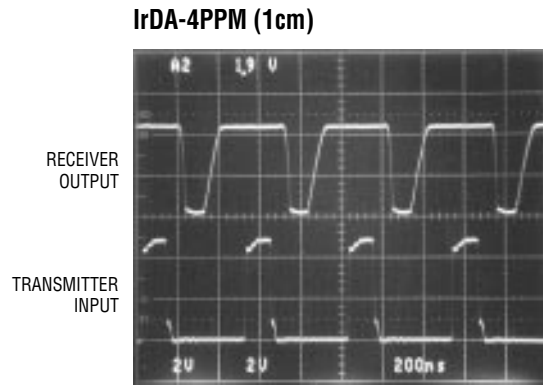

5c

Figure 5. IrDA-4PPM

PCB LAYOUT AND FILM

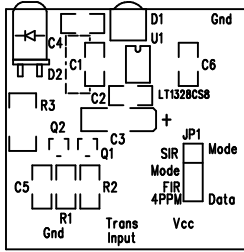

Component Side Silkscreen

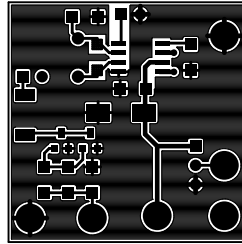

Component Side

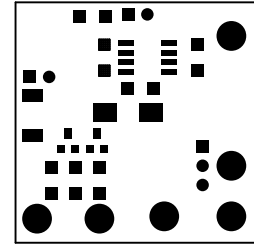

Component Side Solder Mask

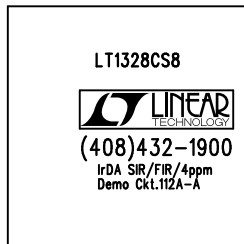

Solder Side Silkscreen

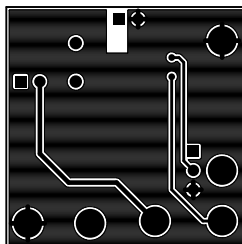

Solder Side

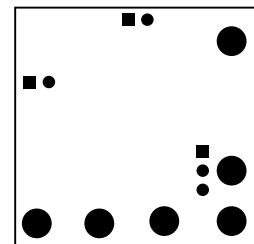

Solder Side Solder Mask

DEMO MANUAL DC112A

PC FAB DRAWING

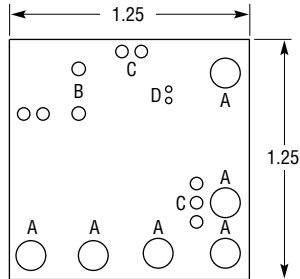

| SYMBOL | DIAMETER | NUMBER OF HOLES |
|-------------|----------|-----------------|
| A | 0.094 | 6 |
| B | 0.042 | 2 |
| C | 0.037 | 7 |
| D | 0.015 | 2 |
| TOTAL HOLES | | 17 |

NOTES:

1. MATERIAL: 2 LAYERS, 0.062" THICK, FR-4 GLASS EPOXY 20Z COPPER CLAD
2. ALL HOLES SHALL BE PLATED THROUGH
3. PLATE THROUGH HOLES WITH COPPER 0.0014 MIN THICKNESS. ALL HOLE SIZES IN HOLE TABLE ARE AFTER PLATING
4. SILKSCREEN: WHITE EPOXY NONCONDUCTIVE INK
5. FINISH: SMOBC
6. SOLDER MASK: LPI, GREEN
7. SCORING:

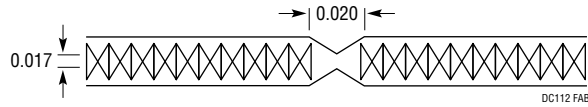

DC112 FAB