

P	LTR	DESCRIPTION	DATE	DWN	APVD
	BA	INITIAL RELEASE	05JUL2016	KR	TN
	BA1	CORRECTIONS TO PAD DIMENSION	23JUN2022	DM	AP
	BA2	DRAWING SCHEDULE UPDATED	31MAY2023	DM	AP

FOR FURTHER INFORMATION SEE DATA SHEET FOR 3522 SERIES

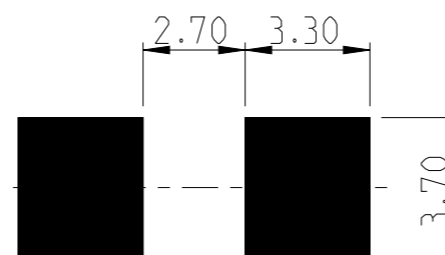

PCB LAYOUT PLAN

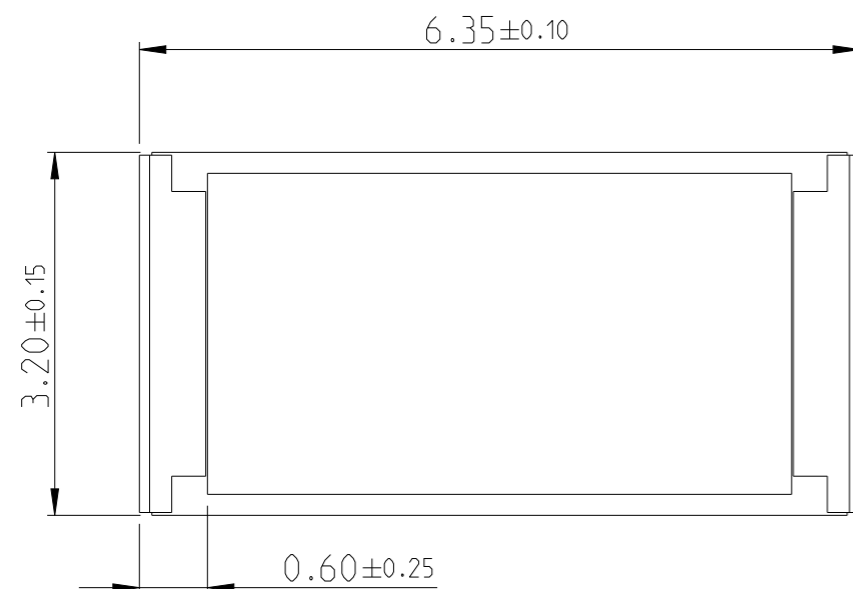

4 LAYERS PCB SPECIFICATION:

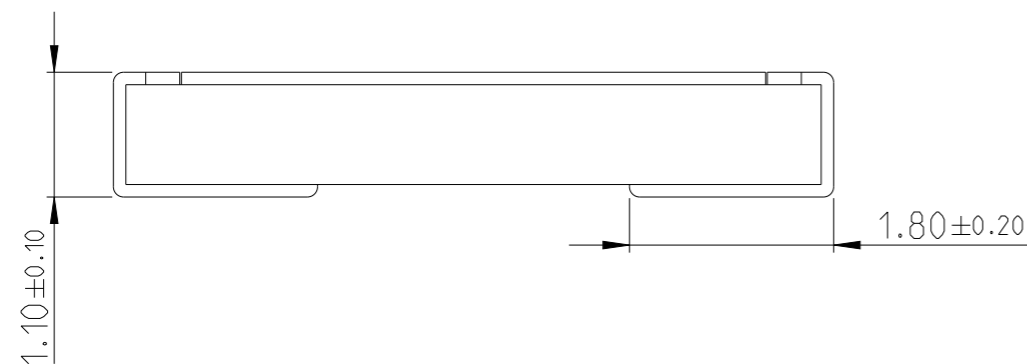
- 1) OUTSIDE 2 LAYERS (TOP AND BOTTOM) WITH COPPER FOIL THICKNESS AT 2 oz.
- 2) INSIDE 2 LAYERS (MIDDLE LAYERS) WITH COPPER FOIL THICKNESS AT 4 oz.

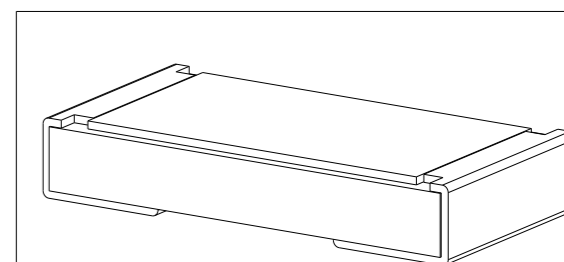

RoHS Compliant



THIS DRAWING IS A CONTROLLED DOCUMENT.		DWN RAGHAVENDRA K 05JUL2016	 TE Connectivity	
DIMENSIONS: mm		CHK ALLAN P 05JUL2016		
TOLERANCES UNLESS OTHERWISE SPECIFIED:		APVD TONY N 05JUL2016	NAME SMD POWER RESISTORS - TYPE 3522 SERIES	
		PRODUCT SPEC -	APPLICATION SPEC -	
MATERIAL -		FINISH -	WEIGHT 0.03806 Gram	RESTRICTED TO -
			SIZE A3	CAGE CODE 00779
			DRAWING NO C=2176230	
			SCALE 5:1	SHEET 1 OF 3
				REV BA2

REVISIONS

P	LTR	DESCRIPTION	DATE	DWN	APVD
	-	SEE SHEET 1	-	-	-

SCHEDULE

TCPN	CATALOGUE NUMBER	PART DESCRIPTION	PART STATUS
2176230-1	3522ZR	3522 0R0 5% 3W	PRODUCTION
2176230-2	35221R0JT	3522 1R0 5% 3W	PRODUCTION
2176230-3	35221R2JT	3522 1R2 5% 3W	PRODUCTION
2176230-4	35221R5JT	3522 1R5 5% 3W	PRODUCTION
2176230-5	35221R8JT	3522 1R8 5% 3W	PRODUCTION
2176230-6	35222R2JT	3522 2R2 5% 3W	PRODUCTION
2176230-7	35222R7JT	3522 2R7 5% 3W	PRODUCTION
2176230-8	35223R3JT	3522 3R3 5% 3W	PRODUCTION
2176230-9	35223R9JT	3522 3R9 5% 3W	PRODUCTION
1-2176230-0	35224R7JT	3522 4R7 5% 3W	PRODUCTION
1-2176230-1	35225R6JT	3522 5R6 5% 3W	PRODUCTION
1-2176230-2	35226R8JT	3522 6R8 5% 3W	PRODUCTION
1-2176230-3	35228R2JT	3522 8R2 5% 3W	PRODUCTION
1-2176230-4	352210RJT	3522 10R 5% 3W	PRODUCTION
1-2176230-5	352212RJT	3522 12R 5% 3W	PRODUCTION
1-2176230-6	352215RJT	3522 15R 5% 3W	PRODUCTION
1-2176230-7	352218RJT	3522 18R 5% 3W	PRODUCTION
1-2176230-8	352222RJT	3522 22R 5% 3W	PRODUCTION
1-2176230-9	352227RJT	3522 27R 5% 3W	PRODUCTION
2-2176230-0	352233RJT	3522 33R 5% 3W	PRODUCTION
2-2176230-1	352239RJT	3522 39R 5% 3W	PRODUCTION
2-2176230-2	352247RJT	3522 47R 5% 3W	PRODUCTION
2-2176230-3	352256RJT	3522 56R 5% 3W	PRODUCTION
2-2176230-4	352268RJT	3522 68R 5% 3W	PRODUCTION
2-2176230-5	352282RJT	3522 82R 5% 3W	PRODUCTION
2-2176230-6	3522100RJT	3522 100R 5% 3W	PRODUCTION
2-2176230-7	3522120RJT	3522 120R 5% 3W	PRODUCTION
2-2176230-8	3522150RJT	3522 150R 5% 3W	PRODUCTION
2-2176230-9	3522180RJT	3522 180R 5% 3W	PRODUCTION
3-2176230-0	3522220RJT	3522 220R 5% 3W	PRODUCTION

SCHEDULE

TCPN	CATALOGUE NUMBER	PART DESCRIPTION	PART STATUS
3-2176230-1	3522270RJT	3522 270R 5% 3W	PRODUCTION
3-2176230-2	3522330RJT	3522 330R 5% 3W	PRODUCTION
3-2176230-3	3522390RJT	3522 390R 5% 3W	PRODUCTION
3-2176230-4	3522470RJT	3522 470R 5% 3W	PRODUCTION
3-2176230-5	3522560RJT	3522 560R 5% 3W	PRODUCTION
3-2176230-6	3522680RJT	3522 680R 5% 3W	PRODUCTION
3-2176230-7	3522820RJT	3522 820R 5% 3W	PRODUCTION
3-2176230-8	35221K0JT	3522 1K0 5% 3W	PRODUCTION
3-2176230-9	35221K2JT	3522 1K2 5% 3W	PRODUCTION
4-2176230-0	35221K5JT	3522 1K5 5% 3W	PRODUCTION
4-2176230-1	35221K8JT	3522 1K8 5% 3W	PRODUCTION
4-2176230-2	35222K2JT	3522 2K2 5% 3W	PRODUCTION
4-2176230-3	35222K7JT	3522 2K7 5% 3W	PRODUCTION
4-2176230-4	35223K3JT	3522 3K3 5% 3W	PRODUCTION
4-2176230-5	35223K9JT	3522 3K9 5% 3W	PRODUCTION
4-2176230-6	35224K7JT	3522 4K7 5% 3W	PRODUCTION
4-2176230-7	35225K6JT	3522 5K6 5% 3W	PRODUCTION
4-2176230-8	35226K8JT	3522 6K8 5% 3W	PRODUCTION
4-2176230-9	35228K2JT	3522 8K2 5% 3W	PRODUCTION
5-2176230-0	352210KJT	3522 10K 5% 3W	PRODUCTION
5-2176230-1	352212KJT	3522 12K 5% 3W	PRODUCTION
5-2176230-2	352215KJT	3522 15K 5% 3W	PRODUCTION
5-2176230-3	352218KJT	3522 18K 5% 3W	PRODUCTION
5-2176230-4	352222KJT	3522 22K 5% 3W	PRODUCTION
5-2176230-5	352227KJT	3522 27K 5% 3W	PRODUCTION
5-2176230-6	352233KJT	3522 33K 5% 3W	PRODUCTION
5-2176230-7	352239KJT	3522 39K 5% 3W	PRODUCTION
5-2176230-8	352247KJT	3522 47K 5% 3W	PRODUCTION
5-2176230-9	352256KJT	3522 56K 5% 3W	PRODUCTION
6-2176230-0	352268KJT	3522 68K 5% 3W	PRODUCTION

THIS DRAWING IS A CONTROLLED DOCUMENT.

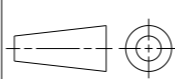
DIMENSIONS: mm	TOLERANCES UNLESS OTHERWISE SPECIFIED:
	0 PLC ± 1 PLC ±0.5 2 PLC ±0.13 3 PLC ±0.013 4 PLC ±0.0001 ANGLES ±
MATERIAL	FINISH
-	-

DWN RAGHAVENDRA K 05 JUL 2016	CHK ALLAN P 05 JUL 2016	APVD TONY N 05 JUL 2016
PRODUCT SPEC		
APPLICATION SPEC		
WEIGHT 0.03806 Gram		
CUSTOMER DRAWING		



SMD POWER RESISTORS - TYPE 3522 SERIES

SIZE	CAGE CODE	DRAWING NO	RESTRICTED TO
A3	00779	©-2176230	-
SCALE 5:1	SHEET 2 OF 3	REV BA2	

REVISIONS

P	LTR	DESCRIPTION	DATE	DWN	APVD
	-	SEE SHEET 1	-	-	-

SCHEDULE

TCPN	CATALOGUE NUMBER	PART DESCRIPTION	PART STATUS
6-2176230-1	352282KJT	3522 82K 5% 3W	PRODUCTION
6-2176230-2	3522100KJT	3522 100K 5% 3W	PRODUCTION
6-2176230-3	3522120KJT	3522 120K 5% 3W	PRODUCTION
6-2176230-4	3522150KJT	3522 150K 5% 3W	PRODUCTION
6-2176230-5	3522180KJT	3522 180K 5% 3W	PRODUCTION
6-2176230-6	3522220KJT	3522 220K 5% 3W	PRODUCTION
6-2176230-7	3522270KJT	3522 270K 5% 3W	PRODUCTION
6-2176230-8	3522330KJT	3522 330K 5% 3W	PRODUCTION
6-2176230-9	3522390KJT	3522 390K 5% 3W	PRODUCTION
7-2176230-0	3522470KJT	3522 470K 5% 3W	PRODUCTION
7-2176230-1	3522560KJT	3522 560K 5% 3W	PRODUCTION
7-2176230-2	3522680KJT	3522 680K 5% 3W	PRODUCTION
7-2176230-3	3522820KJT	3522 820K 5% 3W	PRODUCTION
7-2176230-4	35221M0JT	3522 1M0 5% 3W	PRODUCTION
7-2176230-5	35221M2JT	3522 1M2 5% 3W	PRODUCTION
7-2176230-6	35221M5JT	3522 1M5 5% 3W	PRODUCTION
7-2176230-7	35221M8JT	3522 1M8 5% 3W	PRODUCTION
7-2176230-8	35222M2JT	3522 2M2 5% 3W	PRODUCTION
7-2176230-9	35222M7JT	3522 2M7 5% 3W	PRODUCTION
8-2176230-0	35223M3JT	3522 3M3 5% 3W	PRODUCTION
8-2176230-1	35223M9JT	3522 3M9 5% 3W	PRODUCTION
8-2176230-2	35224M7JT	3522 4M7 5% 3W	PRODUCTION
8-2176230-3	35225M6JT	3522 5M6 5% 3W	PRODUCTION
8-2176230-4	35226M8JT	3522 6M8 5% 3W	PRODUCTION
8-2176230-5	35228M2JT	3522 8M2 5% 3W	PRODUCTION
8-2176230-6	352210MJT	3522 10M 5% 3W	PRODUCTION
8-2176230-7	3522200RJT	3522 200R 5% 3W	PRODUCTION
8-2176230-8	3522300RJT	3522 300R 5% 3W	PRODUCTION
8-2176230-9	3522750RJT	3522 750R 5% 3W	PRODUCTION

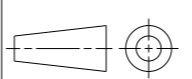
THIS DRAWING IS A CONTROLLED DOCUMENT.		DWN 05JUL2016 RAGHAVENDRA K	 TE Connectivity	
DIMENSIONS: mm		CHK 05JUL2016 ALLAN P		
		APVD 05JUL2016 TONY N	NAME SMD POWER RESISTORS - TYPE 3522 SERIES	
TOLERANCES UNLESS OTHERWISE SPECIFIED:		PRODUCT SPEC	RESTRICTED TO	
0 PLC ±-		APPLICATION SPEC	SIZE	CAGE CODE
1 PLC ±0.5			A3	00779
2 PLC ±0.13			DRAWING NO C=2176230	
3 PLC ±0.013			SCALE 5:1	
4 PLC ±0.0001			SHEET 3 OF 3	
ANGLES ±		WEIGHT 0.03806 Gram	REV BA2	
MATERIAL		CUSTOMER DRAWING		