

2.5-V to 18-V High-Efficiency Hot-Swap Controller

Check for Samples: [TPS24700](#), [TPS24701](#)

FEATURES

- 2.5-V to 18-V Operation
- Accurate Current Limiting for Startup
- Accurate 25-mV Current Sense Threshold
- Timed Overcurrent Breaker
- Power-Good Output
- Fast Breaker for Short-Circuit Protection
- Latch Off (TPS24700) and Retry Versions (TPS24701)
- Programmable UV Threshold
- Drop-In Upgrade for LTC4211 – No Layout Changes
- Small MSOP-8 Package

APPLICATIONS

- Server Backplanes
- Storage Area Networks (SAN)
- Medical Systems
- Plug-In Modules
- Base Stations
- Consumer Electronics

DESCRIPTION

The TPS24700/1 is an easy-to-use, 2.5 V to 18 V, hot-swap controller that drives an external N-channel MOSFET. The programmable current limit and fault time protect the supply and load from excessive current at startup. After startup, currents above the user-selected limit are allowed to flow until programmed timeout – except in extreme overload events when load is immediately disconnected from source. The low, 25-mV current sense threshold is highly accurate and allows use of smaller, more-efficient sense resistors, yielding lower power loss and smaller footprint. A power-good output is provided for status monitoring and downstream load control.

TPS24700/1 replaces the LTC4211 in existing designs with no PCB board changes and only minor external component changes – yielding a more accurate, efficient solution.

TYPICAL APPLICATION OF TPS24700/1 (12 V AT 10 A)

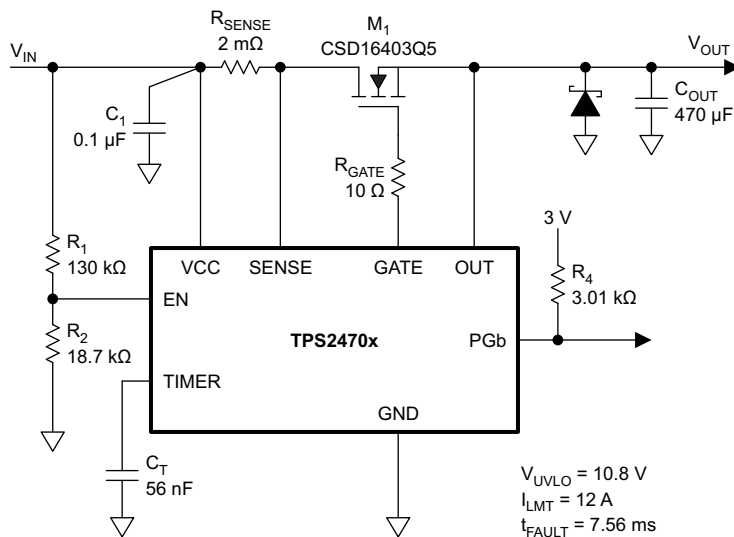

PINOUT

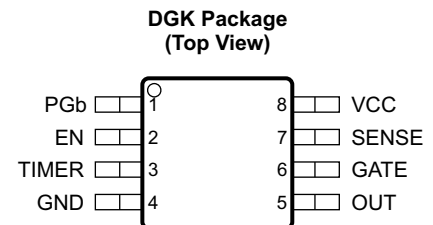

Please be aware that an important notice concerning availability, standard warranty, and use in critical applications of Texas Instruments semiconductor products and disclaimers thereto appears at the end of this data sheet.



This integrated circuit can be damaged by ESD. Texas Instruments recommends that all integrated circuits be handled with appropriate precautions. Failure to observe proper handling and installation procedures can cause damage.

ESD damage can range from subtle performance degradation to complete device failure. Precision integrated circuits may be more susceptible to damage because very small parametric changes could cause the device not to meet its published specifications.

DEVICE INFORMATION

T _A	PACKAGE	PART NUMBER ⁽¹⁾	FUNCTION	MARKING
–40°C to 85°C	MSOP-8	TPS24700	Latched	24700
		TPS24701	Retry	24701

(1) For the most current package and ordering information, see the Package Option Addendum at the end of this document, or see the TI Web site at www.ti.com.

ABSOLUTE MAXIMUM RATINGS

over operating free-air temperature range, all voltages referred to GND (unless otherwise noted)

		VALUE	UNIT	
Input voltage range	EN, GATE, OUT, PGb ⁽¹⁾ , SENSE, VCC	–0.3 to 30	V	
	SENSE to VCC	–0.3 to 0.3		
	TIMER	–0.3 to 5		
Sink current	PGb	5	mA	
ESD rating	Human-body model	All pins except PGb	2	kV
		PGb	0.5	
	Charged-device model	0.5		
Temperature	Maximum junction, T _J	Internally limited	°C	

(1) Do not apply voltages directly to these pins.

THERMAL INFORMATION

THERMAL METRIC ⁽¹⁾		TPS24700/01	UNIT
		MSOP (8) PINS	
θ _{JA}	Junction-to-ambient thermal resistance	57.2	°C/W
θ _{JCtop}	Junction-to-case (top) thermal resistance	110.5	°C/W
θ _{JB}	Junction-to-board thermal resistance	60.7	°C/W
ψ _{JT}	Junction-to-top characterization parameter	7.8	°C/W
ψ _{JB}	Junction-to-board characterization parameter	24	°C/W
θ _{JCbot}	Junction-to-case (bottom) thermal resistance	14.3	°C/W

(1) For more information about traditional and new thermal metrics, see the *IC Package Thermal Metrics* application report, [SPRA953](http://www.ti.com/lit/zip/Spra953).

RECOMMENDED OPERATING CONDITIONS

over operating free-air temperature range (unless otherwise noted)

		MIN	NOM	MAX	UNIT
Input voltage range	SENSE, VCC	2.5		18	V
	EN, PGb, OUT	0		18	
Sink current	PGb	0		2	mA
External capacitance	TIMER	1			nF
	GATE ⁽¹⁾			1	μF
Operating junction temperature range, T _J		-40		125	°C

(1) External capacitance tied to GATE should be in series with a resistor no less than 1 kΩ.

ELECTRICAL CHARACTERISTICS

 -40°C ≤ T_J ≤ 125°C, V_{CC} = 12 V, and V_{EN} = 3 V.

All voltages referenced to GND, unless otherwise noted.

PARAMETER	CONDITIONS	MIN	NOM	MAX	UNIT
VCC					
UVLO threshold, rising		2.2	2.32	2.45	V
UVLO threshold, falling		2.1	2.22	2.35	V
UVLO hysteresis ⁽¹⁾			0.1		V
Supply current	Enabled — I _{OUT} + I _{VCC} + I _{SENSE}		1	1.4	mA
	Disabled — EN = 0 V, I _{OUT} + I _{VCC} + I _{SENSE}		0.45		mA
EN					
Threshold voltage, falling		1.2	1.3	1.4	V
Hysteresis ⁽¹⁾			50		mV
Input leakage current	0 V ≤ V _{EN} ≤ 30 V	-1	0	1	μA
Turnoff time	EN ↓ to V _{GATE} < 1 V, C _{GATE} = 33 nF	20	60	150	μs
Deglintch time	EN ↑	8	14	18	μs
Disable delay	EN ↓ to GATE ↓, C _{GATE} = 0, t _{pf50-90} , See Figure 1	0.1	0.4	1	μs
PGb					
Threshold	V _(SENSE-OUT) rising, PGb going high	140	240	340	mV
Hysteresis ⁽¹⁾	Measured V _(SENSE-OUT) falling, PGb going low		70		
Output low voltage	Sinking 2 mA		0.11	0.25	V
Input leakage current	V _{PGb} = 0 V, 30 V	-1	0	1	μA
Delay (deglintch) time	Rising or falling edge	2	3.4	6	ms
TIMER					
Sourcing current	V _{TIMER} = 0 V	8	10	12	μA
Sinking current	V _{TIMER} = 2 V	8	10	12	μA
	V _{EN} = 0 V, V _{TIMER} = 2 V	2	4.5	7	mA
Upper threshold voltage		1.3	1.35	1.4	V
Lower threshold voltage		0.33	0.35	0.37	V
Timer activation voltage	Raise GATE until I _{TIMER} sinking, measure V _(GATE-VCC) , V _{CC} = 12 V	5	5.9	7	V
Bleed-down resistance	V _{TIMER} = 2 V	70	104	130	kΩ
OUT					
Input bias current	V _{OUT} = 12 V		16	30	μA
GATE					
Output voltage	V _{OUT} = 12 V	23.5	25.8	28	V
Clamp voltage	Inject 10 μA into GATE, measure V _(GATE-VCC)	12	13.9	15.5	V
Sourcing current	V _{GATE} = 12 V	20	30	40	μA

(1) These parameters are provided for reference only and do not constitute part of TI's published device specifications for purposes of TI's product warranty.

ELECTRICAL CHARACTERISTICS (continued)

–40°C ≤ T_J ≤ 125°C, V_{CC} = 12 V, and V_{EN} = 3 V.

All voltages referenced to GND, unless otherwise noted.

PARAMETER	CONDITIONS	MIN	NOM	MAX	UNIT
Sinking current	Fast turnoff, V _{GATE} = 14 V	0.5	1	1.4	A
	Sustained, V _{GATE} = 4 V to 23 V	6	11	20	mA
	In inrush current limit, V _{GATE} = 4 V–23 V	20	30	40	μA
Pulldown resistance	Thermal shutdown	14	20	26	kΩ
Turnon delay	V _{CC} rising to GATE sourcing, t _{prf50-50} , See Figure 2		100	250	μs
SENSE					
Input bias current	V _{SENSE} = 12 V, sinking current		30	40	μA
Current limit threshold	V _{OUT} = 12 V	22.5	25	27.5	mV
Fast-trip threshold		52	60	68	mV
Fast-turnoff duration		8	13.5	18	μs
Fast-turnoff delay	V _(VCC-VSENSE) = 80 mV, C _{GATE} = 0 pF, t _{prf50-50} , See Figure 3		200		ns
OTSD					
Threshold, rising		130	140		°C
Hysteresis ⁽¹⁾			10		°C

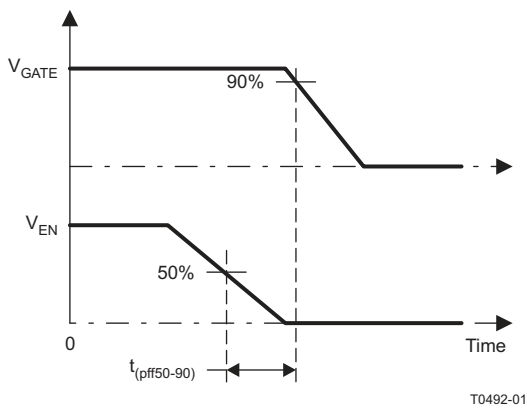

Figure 1. t_{pff50-90} Timing Definition

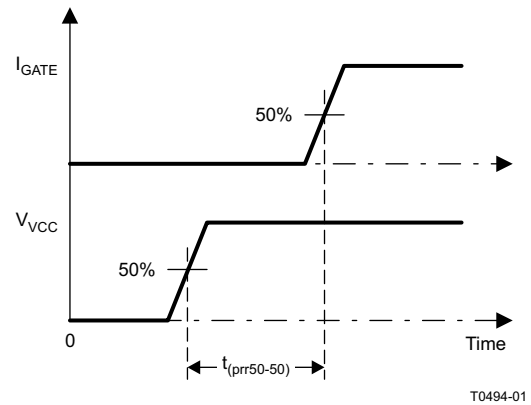

Figure 2. t_{prr50-50} Timing Definition

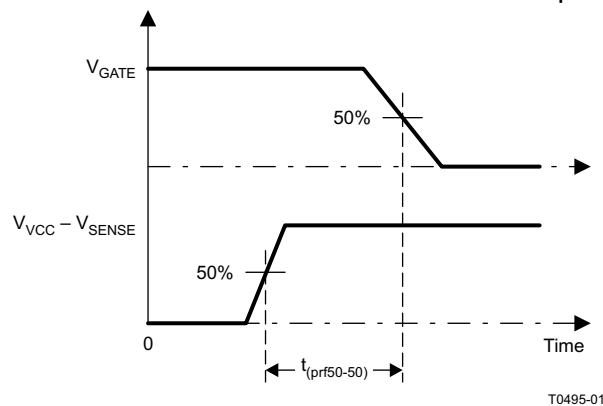
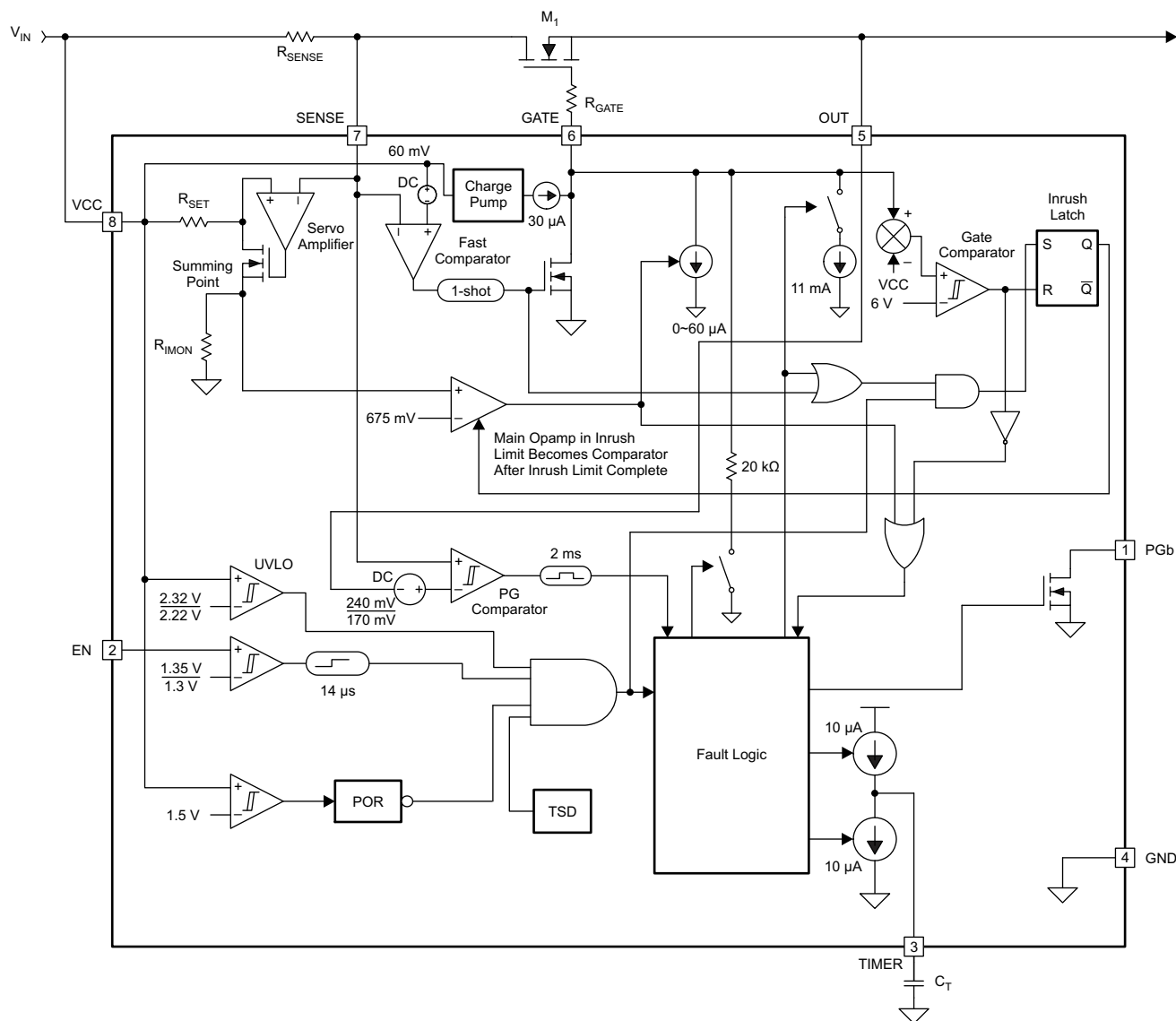

Figure 3. t_{prf50-50} Timing Definition

FUNCTIONAL BLOCK DIAGRAM



B0438-03

Figure 4. Block Diagram of the TPS24700/1

PIN FUNCTIONS

NAME	TPS24700/1	I/O	DESCRIPTION
EN	2	I	Active-high enable input. Logic input. Connects to resistor divider
GATE	6	O	Gate driver output for external MOSFET
GND	4	-	Ground
OUT	5	I	Output voltage sensor for monitoring MOSFET power
PGb	1	O	Active-low, open-drain power good indicator. Status is determined by the voltage across the MOSFET.
SENSE	7	I	Current sensing input for resistor shunt from VCC to SENSE
TIMER	3	I/O	A capacitor connected from this pin to GND provides a fault timing function.
VCC	8	I	Input-voltage sense and power supply

DETAILED PIN DESCRIPTIONS

The following description relies on the typical application diagram shown on the front page of this data sheet, as well as the functional block diagram of [Figure 4](#).

EN: Applying a voltage of 1.35 V or more to this pin enables the gate driver. The addition of an external resistor divider allows the EN pin to serve as an undervoltage monitor. Cycling EN low and then back high resets a TPS24700 that has latched off due to a fault condition. This pin should not be left floating.

GATE: This pin provides gate drive to the external MOSFET. A charge pump sources 30 μ A to enhance the external MOSFET. A 13.9-V clamp between GATE and VCC limits the gate-to-source voltage, because V_{VCC} is very close to V_{OUT} in normal operation. During start-up, a transconductance amplifier regulates the gate voltage of M1 to provide inrush current limiting. The TIMER pin charges timer capacitor C_T during the inrush. Inrush current limiting continues until the $V_{(GATE-VCC)}$ exceeds the Timer Activation Voltage (6 V for $V_{VCC} = 12$ V). Then the TPS24700/1 enters into circuit-breaker mode. The Timer Activation Voltage is defined as a threshold voltage. When $V_{(GATE-VCC)}$ exceeds this threshold voltage, the inrush operation is finished and the TIMER stops sourcing current and begins sinking current. In the circuit-breaker mode, the current flowing in R_{SENSE} is compared with the current-limit threshold derived from [Equation 1](#). If the current flowing in R_{SENSE} exceeds the current limit threshold, then MOSFET M1 is turned off. The GATE pin is disabled by the following three mechanisms:

1. GATE is pulled down by an 11-mA current source when
 - The fault timer expires during an overload current fault ($V_{SENSE} > 25$ mV)
 - V_{EN} is below its falling threshold
 - V_{VCC} drops below the UVLO threshold
2. GATE is pulled down by a 1-A current source for 13.5 μ s when a hard output short circuit occurs and $V_{(VCC-SENSE)}$ is greater than 60 mV, i.e., the fast-trip shutdown threshold. After fast-trip shutdown is complete, an 11-mA sustaining current ensures that the external MOSFET remains off.
3. GATE is discharged by a 20-k Ω resistor to GND if the chip die temperature exceeds the OTSD rising threshold.

GATE remains low in latch mode (TPS24700) and attempts a restart periodically in retry mode (TPS24701).

If used, any capacitor connecting GATE and GND should not exceed 1 μ F and it should be connected in series with a resistor of no less than 1 k Ω . No external resistor should be directly connected from GATE to GND or from GATE to OUT.

GND: This pin is connected to system ground.

OUT: This pin allows the controller to measure the drain-to-source voltage across the external MOSFET M1. The power-good indicator (PGb) relies on this information. The OUT pin should be protected from negative voltage transients by a clamping diode or sufficient capacitors. A Schottky diode of 3 A / 40 V in an SMC package is recommended as a clamping diode for high-power applications. The OUT pin should be bypassed to GND with a low-impedance ceramic capacitor in the range of 10 nF to 1 μ F.

PGb: This active-low, open-drain output is intended to interface to downstream dc/dc converters or monitoring circuits. PGb pulls low after the drain-to-source voltage of the FET has fallen below 170 mV and a 3.4-ms deglitch delay has elapsed. It goes open-drain when VDS exceeds 240 mV. PGb assumes high-impedance status after a 3.4-ms deglitch delay once V_{DS} of M1 rises up, resulting from GATE being pulled to GND at any of the following conditions:

- An overload current fault occurs ($V_{SENSE} > 25$ mV).
- A hard output short circuit occurs, leading to $V_{(VCC-SENSE)}$ greater than 60 mV, i.e., the fast-trip shutdown threshold has been exceeded.
- V_{EN} is below its falling threshold.
- V_{VCC} drops below the UVLO threshold.
- Die temperature exceeds the OTSD threshold.

SENSE: This pin connects to the negative terminal of R_{SENSE} . It provides a means of sensing the voltage across this resistor, as well as a way to monitor the drain-to-source voltage across the external FET. The current limit I_{LIM} is set by [Equation 1](#).

$$I_{LIM} = \frac{25 \text{ mV}}{R_{SENSE}} \quad (1)$$

A fast-trip shutdown occurs when $V_{(VCC-VSENSE)}$ exceeds 60 mV.

TIMER: A capacitor C_T connected from the TIMER pin to GND determines the overload fault timing. TIMER sources 10 μ A when an overload is present, and discharges C_T at 10 μ A otherwise. M1 is turned off when V_{TIMER} reaches 1.35 V. In an application implementing auto-retry after a fault, this capacitor also determines the period before the external MOSFET is re-enabled. A minimum timing capacitance of 1 nF is recommended to ensure proper operation of the fault timer. The value of C_T can be calculated from the desired fault time t_{FLT} , using [Equation 2](#).

$$C_T = \frac{10 \mu A}{1.35 V} \times t_{FLT} \quad (2)$$

The latch mode (TPS24700) or the retry mode (TPS24701) occurs if the load current exceeds the current limit threshold or the fast-trip shutdown threshold. While in latch mode, the TIMER pin continues to charge and discharge the attached capacitor periodically. In retry mode, the external MOSFET is disabled for sixteen cycles of TIMER charging and discharging. The TIMER pin is pulled to GND by a 2-mA current source at the end of the 16th cycle of charging and discharging. The external MOSFET is then re-enabled. The TIMER pin capacitor, C_T , can also be discharged to GND during latch mode or retry mode by a 2-mA current source whenever any of the following occurs:

- V_{EN} is below its falling threshold.
- V_{VCC} drops below the UVLO threshold.

VCC: This pin performs three functions. First, it provides biasing power to the integrated circuit. Second, it serves as an input to the power-on reset (POR) and undervoltage lockout (UVLO) functions. The VCC trace from the integrated circuit should connect directly to the positive terminal of R_{SENSE} to minimize the voltage sensing error. Bypass capacitor C_1 , shown in the typical application diagram on the front page, should be connected to the positive terminal of R_{SENSE} . A capacitance of at least 10 nF is recommended.

TYPICAL CHARACTERISTICS

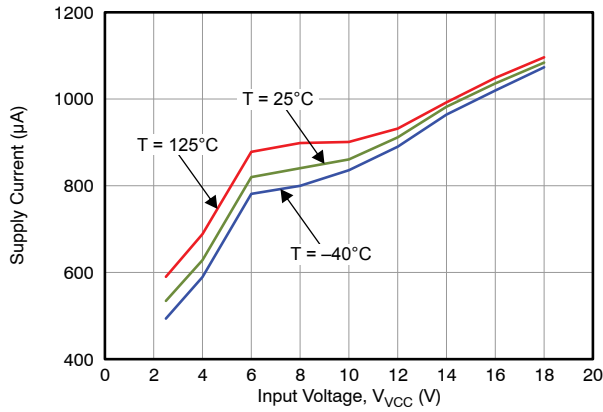

Figure 5. Supply Current vs Input Voltage at Normal Operation (EN = High)

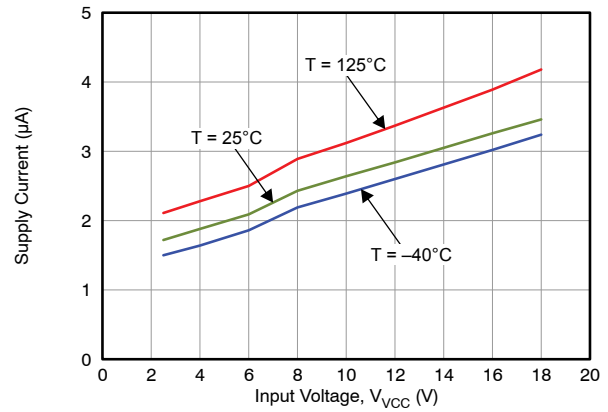

Figure 6. Supply Current vs Input Voltage at Shutdown (EN = 0 V)

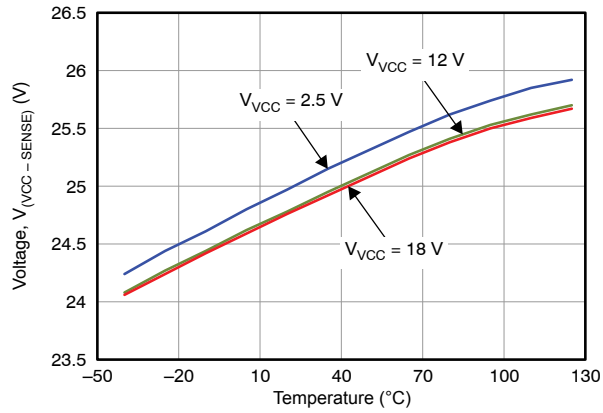

Figure 7. Voltage Across R_{SENSE} in Inrush Current Limiting vs Temperature

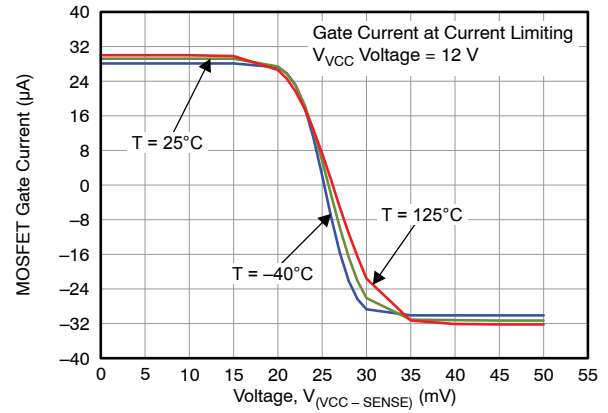

Figure 8. Gate Current vs Voltage Across R_{SENSE} During Inrush Current Limiting

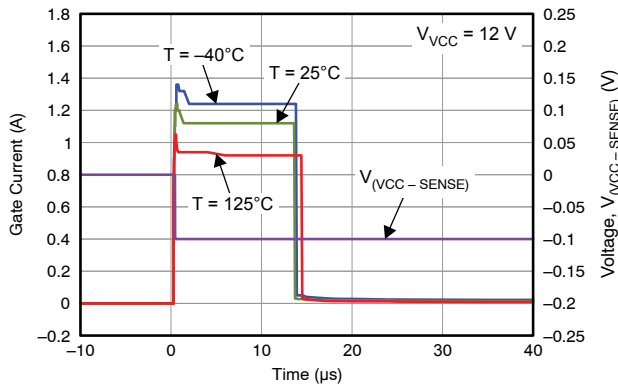

Figure 9. Gate Current During Fast Trip, $V_{VCC} = V_{GATE} = 12 V$

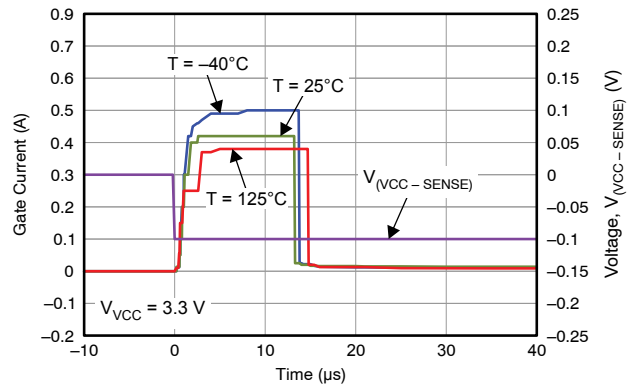

Figure 10. Gate Current During Fast Trip, $V_{VCC} = V_{GATE} = 3.3 V$

TYPICAL CHARACTERISTICS (continued)

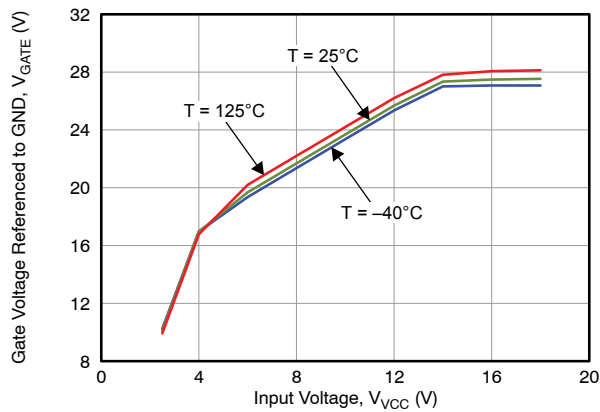

Figure 11. Gate Voltage With Zero Gate Current vs V_{CC}

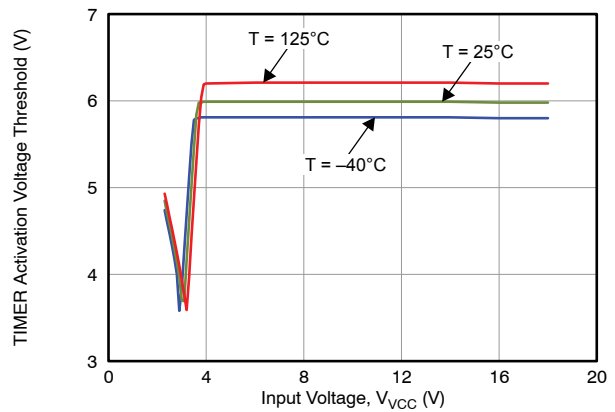

Figure 12. TIMER Activation Voltage Threshold vs V_{CC} at Various Temperatures

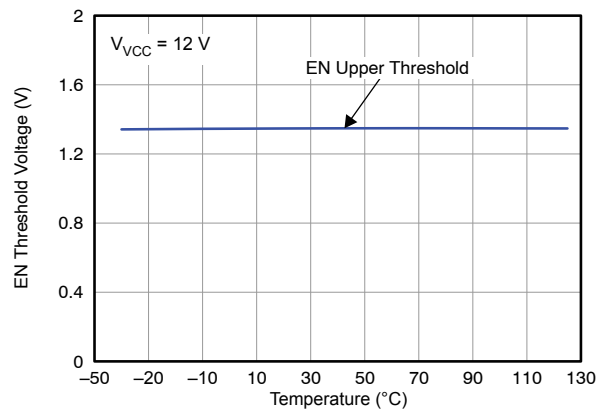

Figure 13. EN Threshold Voltage vs Temperature

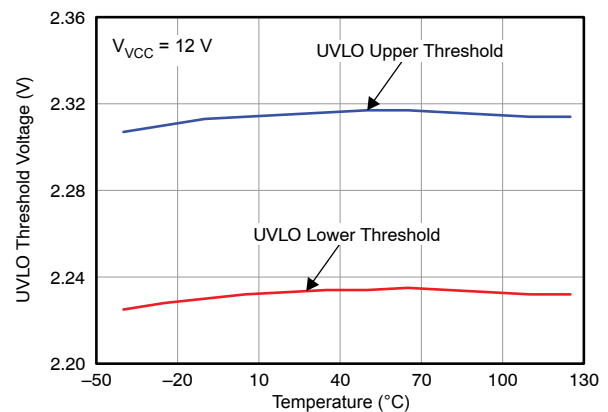

Figure 14. UVLO Threshold Voltages vs Temperature

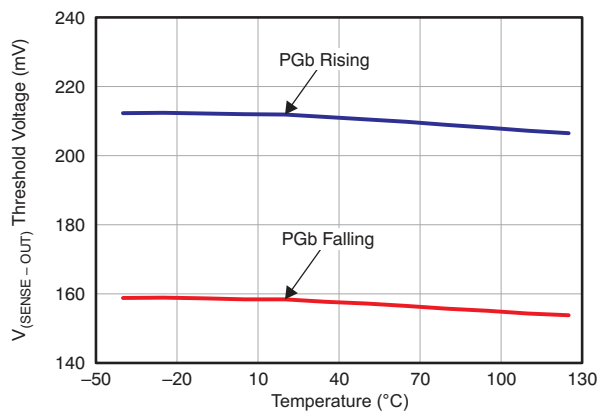

Figure 15. Threshold of V_{DS} vs Temperature, PGB Rising and Falling

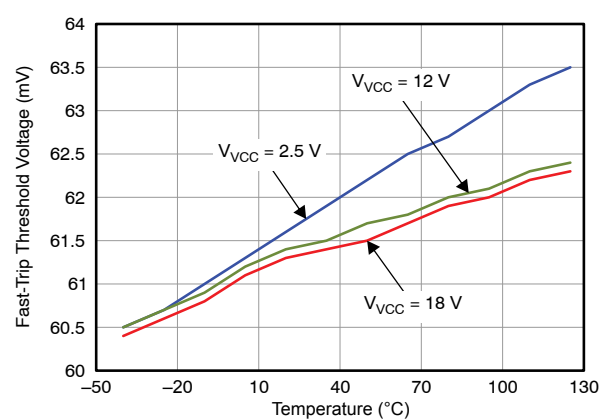

Figure 16. Fast-Trip Threshold vs Temperature

TYPICAL CHARACTERISTICS (continued)

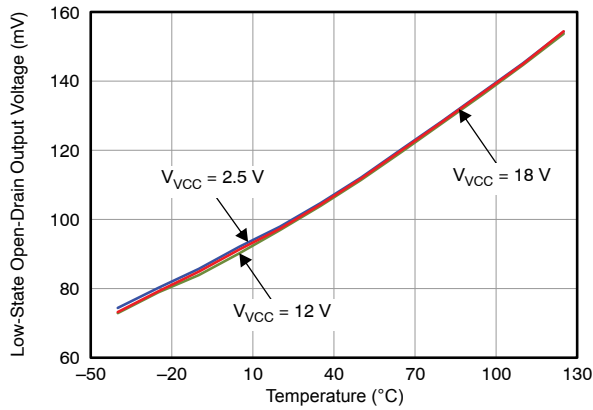

Figure 17. PGb Open-Drain Output Voltage in Low State

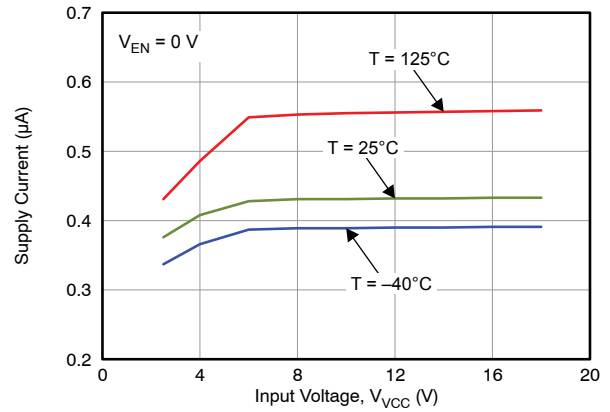

Figure 18. Supply Current vs V_{VCC} and Temperature When EN Pulled Low

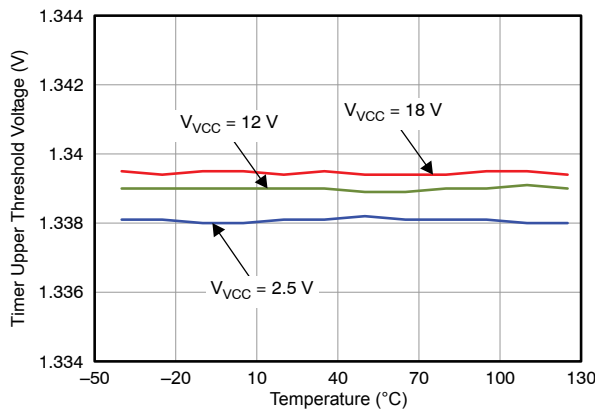

Figure 19. Timer Upper Threshold vs V_{VCC} and Temperature

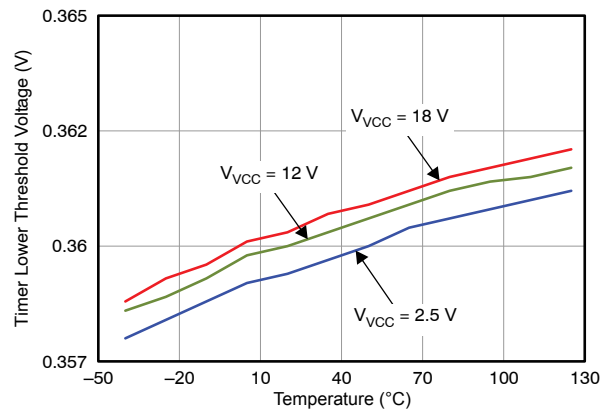

Figure 20. Timer Lower Threshold vs V_{VCC} and Temperature

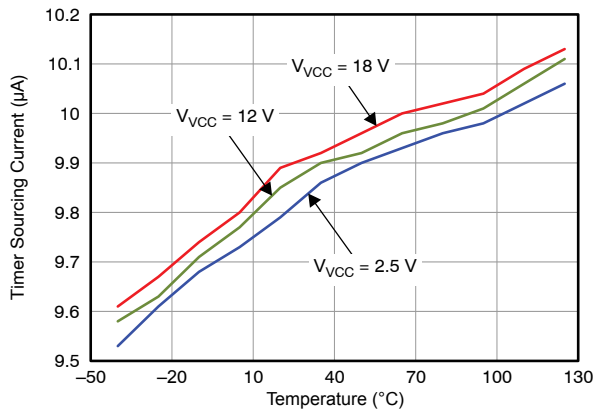

Figure 21. Timer Sourcing Current vs V_{VCC} and Temperature

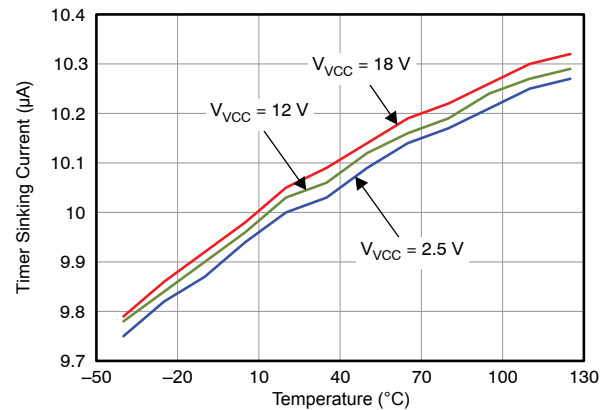

Figure 22. Timer Sinking Current vs V_{VCC} and Temperature

SYSTEM OPERATION

INTRODUCTION

The TPS24700/1 provides all the features needed for a positive hot-swap controller. These features include:

- Undervoltage lockout
- Adjustable (system-level) enable
- Turn-on inrush limiting
- High-side gate drive for an external N-channel MOSFET
- Adjustable overload timeout — also called an electronic circuit breaker
- Charge-complete indicator for downstream converter coordination
- A choice of latch (TPS24700) or automatic restart mode (TPS24701)

The typical application circuit, shown on the front page of this datasheet, and oscilloscope plots, shown in [Figure 23](#) through [Figure 24](#) and [Figure 26](#) through [Figure 28](#), demonstrate many of the functions described previously.

BOARD PLUG IN

[Figure 23](#) illustrates the inrush current that flows when a hot-swap board under the control of the TPS24700/1 is plugged into an input power bus. Only the bypass capacitor charge current and small bias currents are evident when a board is first plugged in. The TPS24700/1 is held inactive for a short period while internal voltages stabilize. In this short period, GATE and TIMER are held low and PGB is held open-drain. When the voltage on the internal VCC rail exceeds approximately 1.5 V, the power-on reset (POR) circuit initializes the TPS24700/1 and a start-up cycle is ready to take place.

GATE, TIMER, and PGB are released after the internal voltages have stabilized and the external EN (enable) threshold has been exceeded. The part begins sourcing current from the GATE pin to turn on MOSFET M1. The TPS24700/1 monitors the drain current passing through MOSFET M1 by measuring the voltage $V_{(VCC - SENSE)}$. Based on the measurement, the TPS24700/1 limits the drain current in the MOSFET to be no more than the current limit I_{LIM} , so as to alleviate the charging impact of the downstream bulk storage capacitors.

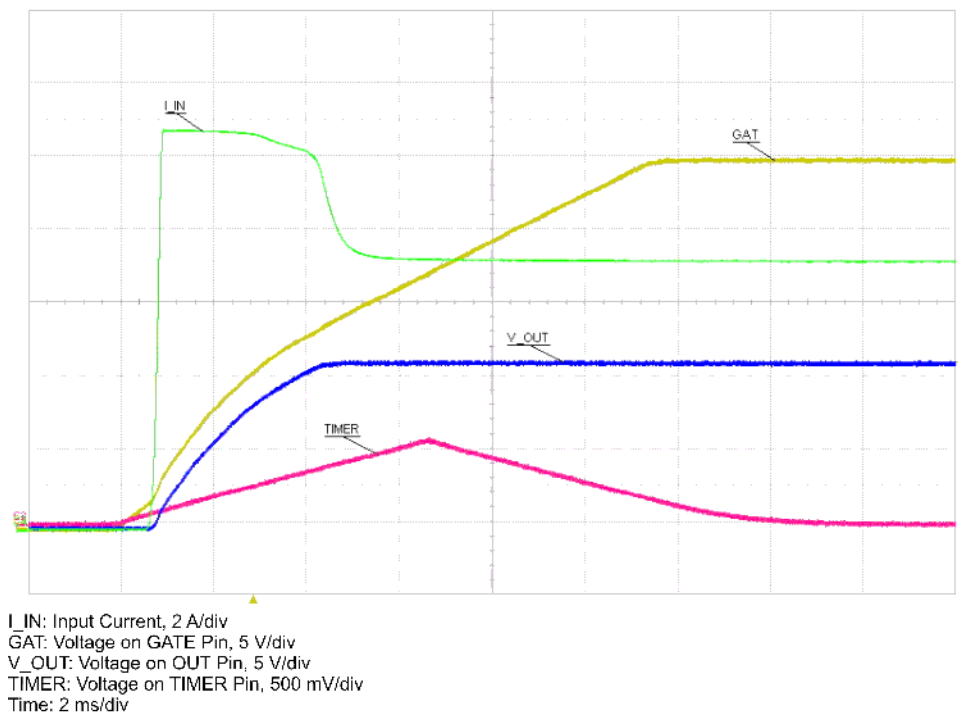

C001

Figure 23. Inrush Mode at Hot-Swap Circuit Insertion

INRUSH OPERATION

When the TPS2470/1 activates MOSFET M1, a current flows into the downstream bulk storage capacitors. When this current exceeds the limit threshold set by [Equation 1](#), the gate of the MOSFET is regulated by a feedback loop to make the MOSFET current stay at a current level no more than the current limit threshold. This limits the inrush current charging capacitance. The TIMER pin begins to charge the timing capacitor C_T with a current of approximately 10 μA . The TIMER pin continues to charge C_T until $V_{(\text{GATE-VCC})}$ reaches the timer activation voltage (6 V for $V_{\text{VCC}} = 12\text{ V}$). The TIMER then begins to discharge C_T with a current of approximately 10 μA . This indicates that the inrush mode is finished. If the TIMER exceeds its upper threshold of 1.35 V before $V_{(\text{GATE-VCC})}$ reaches the timer activation voltage, the GATE pin is pulled to GND and the hot-swap circuit enters either latch mode (TPS24700) or auto-retry mode (TPS24701).

The current limit feature is disabled once the inrush operation is finished and the hot-swap circuit becomes a circuit breaker. The TPS24700/1 turns off the MOSFET, M1, after a fault timer period once the load exceeds the current limit threshold.

CIRCUIT BREAKER AND FAST TRIP

The TPS24700/1 monitors load current by sensing the voltage across R_{SENSE} . The TPS24700/1 incorporates two distinct thresholds: a current-limit threshold and a fast-trip threshold.

[Figure 24](#) shows the behavior of the TPS24700/1 when a fault in the output load causes the current passing through R_{SENSE} to increase to a value above the current limit but less than the fast-trip threshold. When the current exceeds the current-limit threshold, a current of approximately 10 μA begins to charge timing capacitor C_T . If the voltage on C_T reaches 1.35 V, then the external MOSFET is turned off. The TPS24700 latches off and the TPS24701 commences a restart cycle. Overload between the current limit and the fast-trip threshold is permitted for this period. This shutdown scheme is sometimes called an electronic circuit breaker.

The fast-trip threshold protects the system against a severe overload or a dead short circuit. When the voltage across the sense resistor R_{SENSE} exceeds the 60-mV fast-trip threshold, the GATE pin immediately pulls the external MOSFET gate to ground with approximately 1 A of current. This extremely rapid shutdown may generate disruptive transients in the system, in which case a low-value resistor inserted between the GATE pin and the MOSFET gate can be used to moderate the turnoff current. The fast-trip circuit holds the MOSFET off for only a few microseconds, after which the TPS24700/1 turns back on slowly, allowing the current-limit feedback loop to take over the gate control of M1. Then the hot-swap circuit goes into either latch mode (TPS24700) or auto-retry mode (TPS24701). [Figure 26](#) and [Figure 27](#) illustrate the behavior of the system when the current exceeds the fast-trip threshold.

The functions of circuit breaker and fast-trip turnoff are shown in [Figure 24](#) through [Figure 27](#).

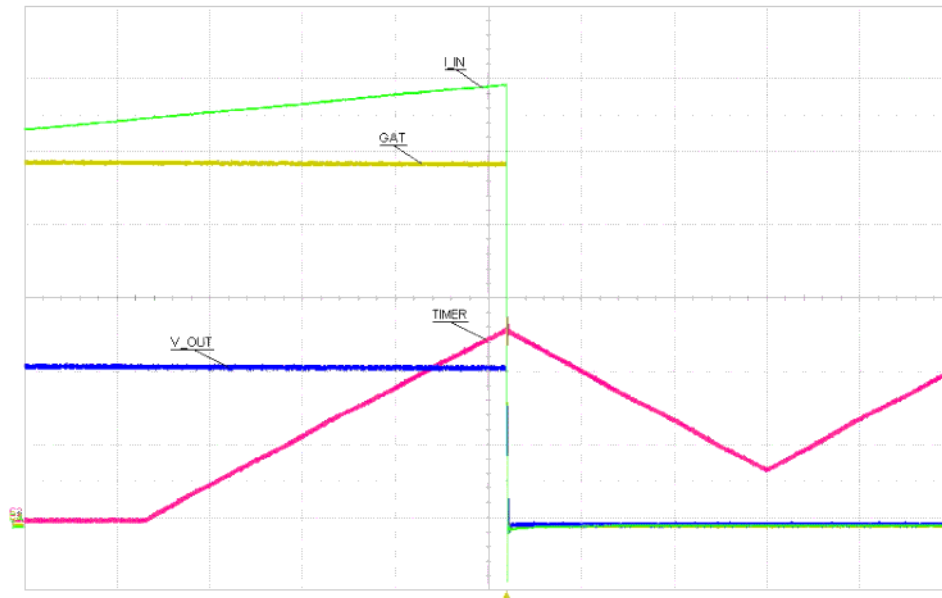

I_IN: Input Current, 2 A/div
 GAT: Voltage on GATE Pin, 5 V/div
 V_OUT: Voltage on OUT Pin, 5 V/div
 TIMER: Voltage on TIMER Pin, 500 mV/div
 Time: 2 ms/div

C003

Figure 24. Circuit-Breaker Mode During Overload Condition

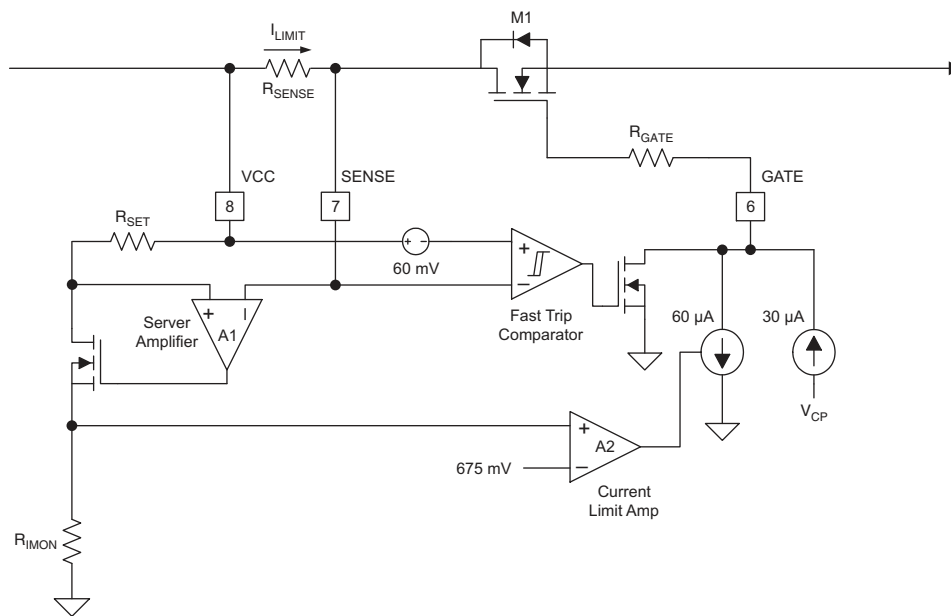

B0439-03

Figure 25. Partial Diagram of the TPS24700/1 With Selected External Components

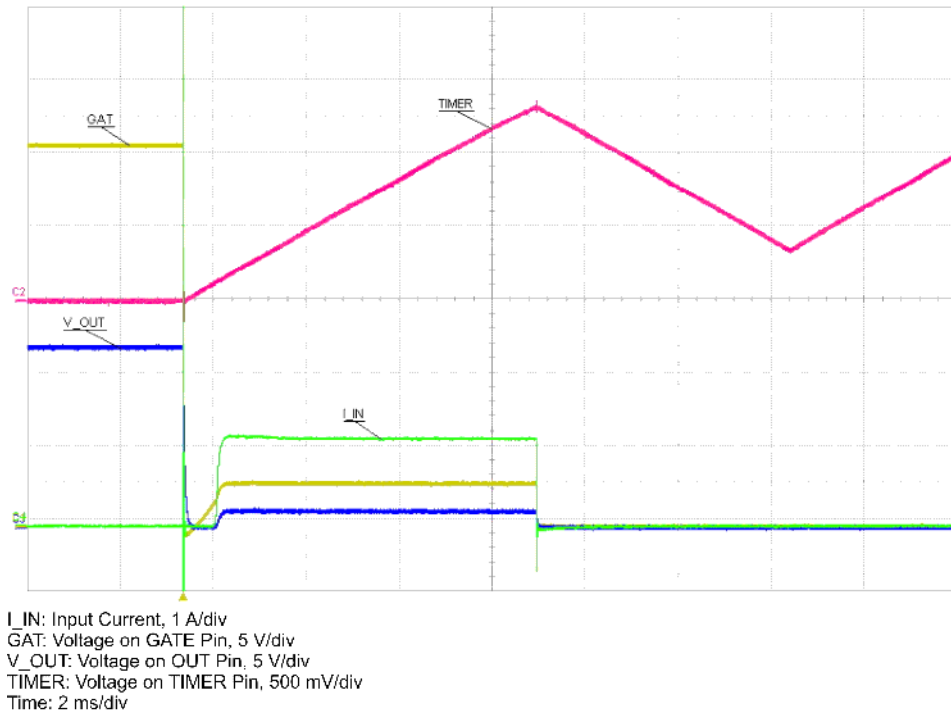

C004

Figure 26. Current Limit During Output Load Short-Circuit Condition (Overview)

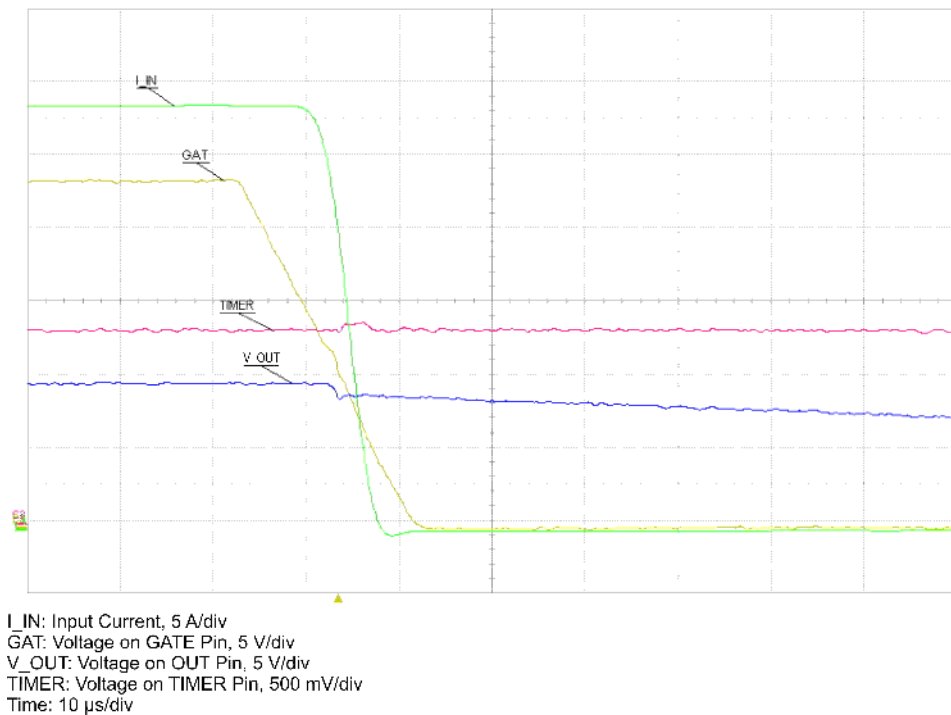

C005

Figure 27. Current Limit During Output-Load Short-Circuit Condition (Onset)

AUTOMATIC RESTART

The TPS24701 automatically initiates a restart after a fault has caused it to turn off the external MOSFET M1.

Internal control circuits use C_T to count 16 cycles before re-enabling M1 as shown in Figure 28. This sequence repeats if the fault persists. The timer has a 1 : 1 charge-to-discharge current ratio. For the very first cycle, the TIMER pin starts from 0 V and rises to the upper threshold of 1.35 V and subsequently falls to 0.35 V before restarting. For the following 16 cycles, 0.35 V is used as the lower threshold. This small duty cycle often reduces the average short-circuit power dissipation to levels associated with normal operation and eliminates special thermal considerations for surviving a prolonged output short.

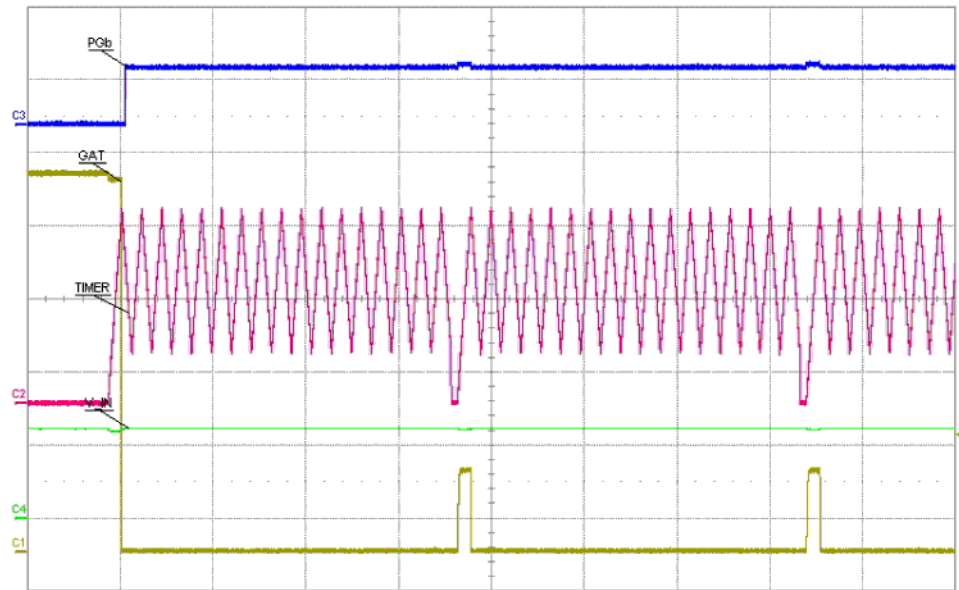

V_IN: Input Voltage, 10 V/div
GAT: Voltage on GATE Pin, 5 V/div
PGB: Voltage on PGb Pin, 5 V/div
TIMER: Voltage on TIMER Pin, 500 mV/div
Time: 50 ms/div

C006

Figure 28. Auto-Restart Cycle Timing

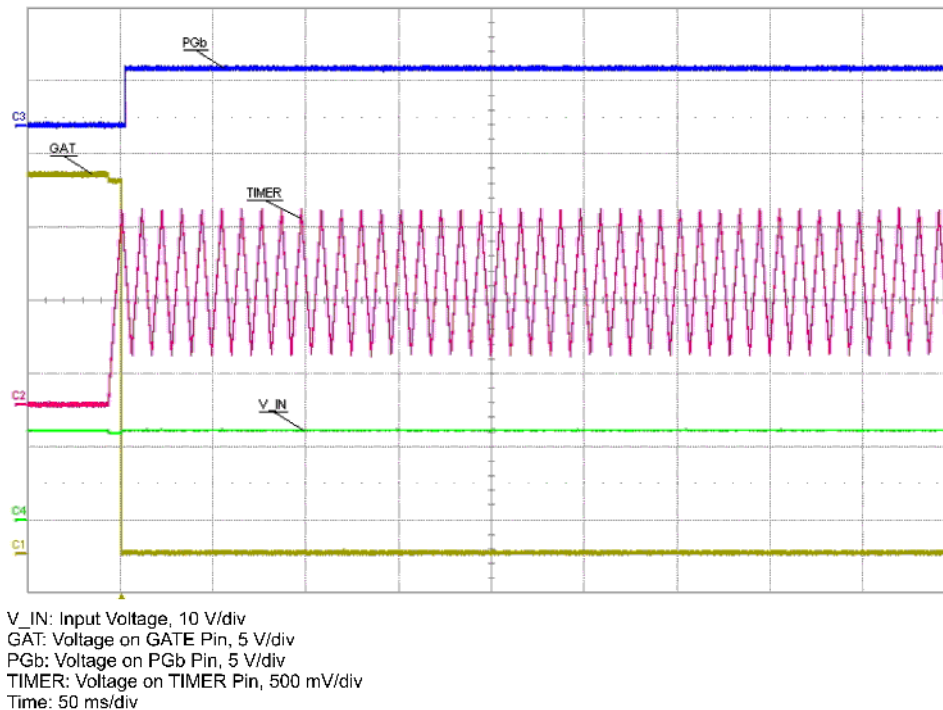

C007

Figure 29. Latch After Overload Fault

PGb AND TIMER OPERATIONS

The open-drain PGB output provides a deglitched end-of-inrush indication based on the voltage across M1. PGB is useful for preventing a downstream dc/dc converter from starting while its input capacitor C_{OUT} is still charging. PGB goes active-low about 3.4 ms after C_{OUT} is charged. This delay allows M1 to fully turn on and any transients in the power circuits to end before the converter starts up. This type of sequencing prevents the downstream converter from demanding full current before the current-limit engine allows the MOSFET to conduct the full current set by the current limit I_{LIM} . Failure to observe this precaution may prevent the system from starting. The pullup resistor shown on the PGB pin in the typical application diagram (front page) is illustrative only; the actual connection to the converter depends on the application. The PGB pin may indicate that inrush has ended before the MOSFET is fully enhanced, but the downstream capacitor will have been charged to substantially its full operating voltage. Care should be taken to ensure that the MOSFET on-resistance is sufficiently small to ensure that the voltage drop across this transistor is less than the minimum power-good threshold of 140 mV. After the hot-swap circuit successfully starts up, the PGB pin can return to a high-impedance status whenever the drain-to-source voltage of MOSFET M1 exceeds its upper threshold of 340 mV, which presents the downstream converters a warning flag. This flag may occur as a result of overload fault, output short fault, high die temperature, or the GATE shutdown by UVLO and EN.

The fault-timer defines an allowed period during which the load current can exceed the programmed current limit (but not the fast-trip threshold). The fault timer starts when a current of approximately 10 μ A begins to flow into the external capacitor, C_T , and ends when the voltage of C_T reaches TIMER upper threshold, i.e., 1.35 V. The fault-timer state requires an external capacitor C_T connected between the TIMER pin and GND pin. The length of the fault timer is the charging time of C_T from 0 V to its upper threshold of 1.35 V. The fault timer begins to count under any of the following three conditions:

- In the inrush mode, TIMER begins to source current to the timer capacitor, C_T , when MOSFET M1 is enabled. TIMER begins to sink current from the timer capacitor, C_T when $V_{(GATE-VCC)}$ exceeds the timer activation voltage (see the *Inrush Operation* section). If $V_{(GATE-VCC)}$ does not reach the timer activation voltage before TIMER reaches 1.35 V, then the TPS24700/1 disables the external MOSFET M1. After the MOSFET turns off, the timer goes into either latch mode (TPS24700) or retry mode (TPS24701).

- In an overload fault, TIMER begins to source current to the timer capacitor, C_T , when the load current exceeds the programmed current limits. When the timer capacitor voltage reaches its upper threshold of 1.35 V, TIMER begins to sink current from the timer capacitor, C_T , and the GATE pin is pulled to ground. After the fault timer period, TIMER may go into latch mode (TPS24700) or retry mode (TPS24701).
- In output short-circuit fault, TIMER begins to source current to the timer capacitor, C_T , when the load current exceeds the current-limit threshold following a fast-trip shutdown of M1. When the timer capacitor voltage reaches its upper threshold of 1.35 V, TIMER begins to sink current from the timer capacitor, C_T , and the GATE pin is pulled to ground. After the fault timer period, TIMER may go into latch mode (TPS24700) or retry mode (TPS24701).

If the fault current drops below the current limit falling threshold within the fault timer period, V_{TIMER} decreases and the pass MOSFET, M1, remains enabled.

The behaviors of TIMER are different in the latch mode (TPS24700) and retry mode (TPS24701). If the timer capacitor reaches the upper threshold of 1.35 V, then:

- In latch mode, the TIMER pin continues to charge and discharge the attached capacitor periodically until TPS24700 is disabled by UVLO or EN as shown in [Figure 29](#).
- In retry mode, TIMER charges and discharges C_T between the lower threshold of 0.35 V and the upper threshold of 1.35 V for sixteen cycles before the TPS24701 attempts to restart. The TIMER pin is pulled to GND at the end of the 16th cycle of charging and discharging and then ramps from 0 V to 1.35 V for the initial half-cycle in which the GATE pin sources current. This periodic pattern is stopped once the overload fault is removed or the TPS24701 is disabled by UVLO or EN.

OVERTEMPERATURE SHUTDOWN

The TPS24700/1 includes a built-in overtemperature shutdown circuit designed to disable the gate driver if the die temperature exceeds approximately 140°C. An overtemperature condition also causes the PGB pin to go to the high-impedance state. Normal operation resumes once the die temperature has fallen approximately 10°C.

START-UP OF HOT-SWAP CIRCUIT BY VCC OR EN

The connection and disconnection between a load and the input power bus are controlled by turning on and turning off the MOSFET, M1.

The TPS24700/1 has two ways to turn on MOSFET M1:

- Increasing V_{VCC} above the UVLO upper threshold while EN is already higher than its upper threshold sources current to the GATE pin. After an inrush period, the TPS24700/1 fully turns on MOSFET M1.
- Increasing EN above its upper threshold while V_{VCC} is already higher than the UVLO upper threshold sources current to the GATE pin. After an inrush period, TPS24700/1 fully turns on MOSFET M1.

The EN pin can be used to start up the TPS24700/1 at a selected input voltage V_{VCC} .

To isolate the load from the input power bus, the GATE pin sinks current and pulls the gate of MOSFET M1 low. The MOSFET can be disabled by any of the following conditions: UVLO, EN, load current above current limit threshold, hard short at load, or OTSD. Three separate mechanisms pull down the GATE pin:

1. GATE is pulled down by an 11-mA current source when any of the following occurs.
 - The fault timer expires during an overload current fault ($V_{SENSE} > 25$ mV).
 - V_{EN} is below its falling threshold.
 - V_{VCC} drops below the UVLO falling threshold.
2. GATE is pulled down by a 1-A current source for 13.5 μ s when a hard output short circuit occurs and $V_{(VCC-SENSE)}$ is greater than 60 mV, i.e., the fast-trip shutdown threshold. After fast-trip shutdown is complete, an 11-mA sustaining current ensures that the external MOSFET remains off.
3. GATE is discharged by a 20-k Ω resistor to GND if the chip die temperature exceeds the OTSD rising threshold.

DESIGN EXAMPLE: CURRENT-LIMITED START-UP

This design example assumes a 12-V system voltage with an operating tolerance of ± 2 V. The rated load current is 10 A, corresponding to a dc load of 1.2 Ω . If the current exceeds 12 A, then the controller should shut down and then attempt to restart. Ambient temperatures may range from 20°C to 50°C. The load has a minimum input capacitance of 470 μ F. Figure 30 shows a simplified system block diagram of the proposed application.

This design procedure seeks to control the junction temperature of MOSFET M1 under both static and transient conditions by proper selection of package, cooling, $r_{DS(on)}$, current limit, fault timeout, and power limit. The design procedure further assumes that a unit running at full load and maximum ambient temperature experiences a brief input power interruption sufficient to discharge C_{OUT} , but short enough to keep M1 from cooling. A full C_{OUT} recharge then takes place. Adjust this procedure to fit your application and design criteria.

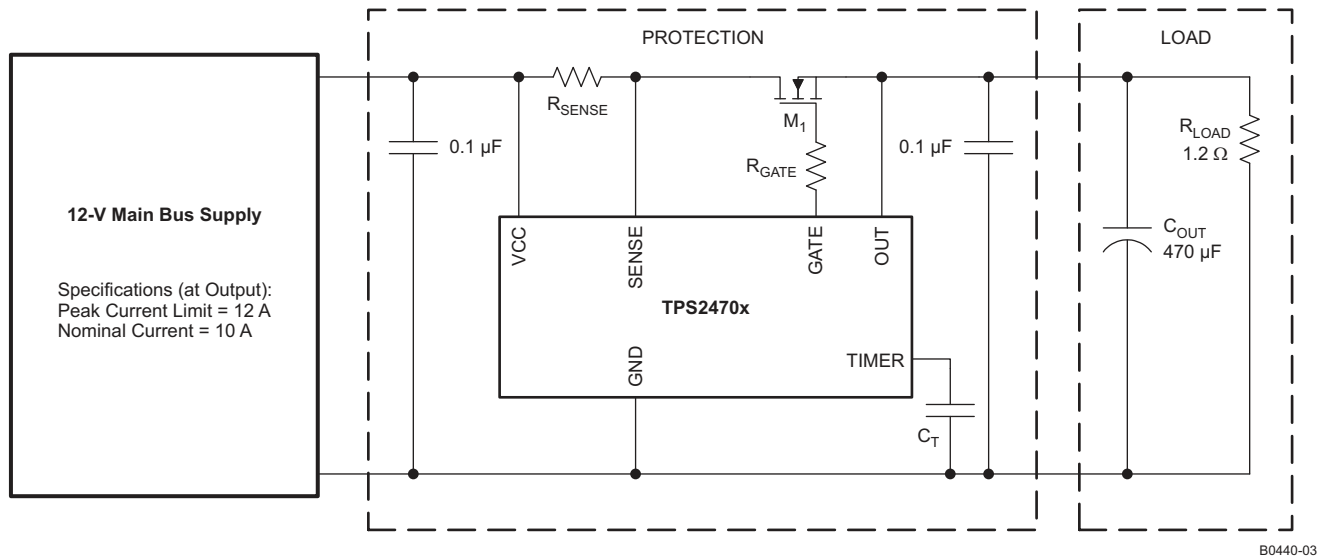

Figure 30. Simplified Block Diagram of the System Constructed in the Design Example

STEP 1. Choose R_{SENSE}

From the TPS24700/1 electrical specifications, the typical current-limit threshold voltage, $V_{(VCC-SENSE)}$, is 25 mV. A resistance of 2 m Ω is selected for the peak current limit of 12 A, while dissipating only 200 mW at the rated 10-A current (see Equation 3). This represents a 0.17% power loss.

$$R_{SENSE} = \frac{V_{(VCC-SENSE)}}{I_{LIM}},$$

therefore,

$$R_{SENSE} = \frac{25 \text{ mV}}{12 \text{ A}} \approx 2 \text{ m}\Omega \quad (3)$$

STEP 2. Choose MOSFET M1

The next design step is to select M1. The TPS24700/1 is designed to use an N-channel MOSFET with a gate-to-source voltage rating of 20 V.

Devices with lower gate-to-source voltage ratings can be used if a Zener diode is connected to limit the maximum gate-to-source voltage across the transistor.

The next factor to consider is the drain-to-source voltage rating, $V_{DS(MAX)}$, of the MOSFET. Although the MOSFET only sees 12 V dc, it may experience much higher transient voltages during extreme conditions, such as the abrupt shutoff that occurs during a fast trip. A TVS may be required to limit inductive transients under such conditions. A transistor with a $V_{DS(MAX)}$ rating of at least twice nominal input power supply voltage is recommended regardless of whether a TVS is used or not.

Next select the on resistance of the transistor, $r_{DS(on)}$. The maximum on-resistance must not generate a voltage greater than the minimum power-good threshold voltage of 140 mV. Assuming a current limit of 12 A, a maximum $r_{DS(on)}$ of 11.67 m Ω is required. Also consider the effect of $r_{DS(on)}$ upon the maximum operating temperature $T_{J(MAX)}$ of the MOSFET. Equation 4 computes the value of $r_{DS(on)(MAX)}$ at a junction temperature of $T_{J(MAX)}$. Most manufacturers list $r_{DS(on)(MAX)}$ at 25°C and provide a derating curve from which values at other temperatures can be derived. Compute the maximum allowable on-resistance, $r_{DS(on)(MAX)}$, using Equation 4.

$$r_{DS(on)(MAX)} = \frac{T_{J(MAX)} - T_{A(MAX)}}{I_{MAX}^2 \times R_{\theta JA}},$$

therefore,

$$r_{DS(on)(MAX)} = \frac{150^\circ\text{C} - 50^\circ\text{C}}{(12 \text{ A})^2 \times 51^\circ\text{C/W}} = 13.6 \text{ m}\Omega \quad (4)$$

Taking these factors into consideration, the TI CSD16403Q5 was selected for this example. This transistor has a $V_{GS(MAX)}$ rating of 16 V, a $V_{DS(MAX)}$ rating of 25 V, and a maximum $r_{DS(on)}$ of 2.8 m Ω at room temperature. During normal circuit operation, the MOSFET can have up to 10 A flowing through it. The power dissipation of the MOSFET equates to 0.24 W and a 9.6°C rise in junction temperature. This is well within the data sheet limits for the MOSFET. The power dissipated during a fault (e.g., output short) is far larger than the steady-state power. The power handling capability of the MOSFET must be checked during fault conditions.

STEP 3. Choose Output Voltage Rising Time, t_{ON} , C_T

The maximum output voltage rise time, t_{ON} , set by the timer capacitor C_T must suffice to fully charge the load capacitance C_{OUT} without triggering the fault circuitry. Equation 5 defines t_{ON} , where $V_{CC(MAX)}$ is the maximum input power bus voltage value and I_{LIM} is the current limit value.

$$t_{ON} = \frac{C_{OUT} \times V_{VCC(MAX)}}{I_{LIM}} \quad \text{if } P_{LIM} > I_{LIM} \times V_{VCC(MAX)}$$

therefore,

$$t_{ON} = \frac{470 \mu\text{F} \times 12 \text{ V}}{12 \text{ A}} = 0.47 \text{ ms} \quad (5)$$

The next step is to determine the minimum fault-timer period. In Equation 5, the output rise time, t_{ON} , is the amount of time it takes to charge the output capacitor up to the final output voltage. However, the fault timer uses the difference between the input voltage and the gate voltage to determine if the TPS24700/1 is still in inrush limit. The fault timer continues to run until V_{GATE} rises 6 V above the input voltage (for $V_{VCC} = 12 \text{ V}$). Some additional time must be added to the total time to account for this additional gate voltage rising. The minimum fault time can be calculated using Equation 6,

$$t_{FLT} = t_{ON} + \frac{6 \text{ V} \times C_{ISS}}{I_{GATE}},$$

therefore,

$$t_{FLT} = 0.47 \text{ ms} + \frac{6 \text{ V} \times 2040 \text{ pF}}{20 \mu\text{A}} = 1.08 \text{ ms} \quad (6)$$

where C_{ISS} is the MOSFET input capacitance and I_{GATE} is the minimum gate sourcing current of TPS24700, or 20 μA . Using the example parameters in Equation 6 and the CSD16403Q5 data sheet leads to a minimum fault time of 1.08 ms. This time is derived considering the tolerances of C_{OUT} , C_{ISS} , I_{LIM} , I_{GATE} , C_{OUT} , and V_{VCC} . The fault timer must be set to a value higher than 1.08 ms to avoid turning off during start-up, but lower than any maximum fault time limit determined by the device SOA curve.

There is a maximum time limit set by the SOA curve of the MOSFET. Referring to Figure 31, which shows the

CSD16403Q5 SOA curve at $T_J = 25^\circ\text{C}$, the MOSFET can tolerate 12 A with 12 V across it for approximately 20 ms. If the junction temperature T_J is other than 25°C , then the pulse time should be scaled by a factor of $(150^\circ\text{C} - T_J) / (150^\circ\text{C} - 25^\circ\text{C})$. Therefore, the fault timer should be set between 1.08 ms and 20 ms. For this example, we will select 7 ms to allow for variation of system parameters such as temperature, load, component tolerance, and input voltage. The timing capacitor is calculated in Equation 2 as 52 nF. Selecting the next-highest standard value, 56 nF, yields a 7.56-ms fault time (see Equation 7).

$$C_T = \frac{10 \mu\text{A}}{1.35 \text{ V}} \times t_{\text{FLT}},$$

therefore,

$$C_T = \frac{10 \mu\text{A}}{1.35 \text{ V}} \times 7 \text{ ms} = 52 \text{ nF} \quad (7)$$

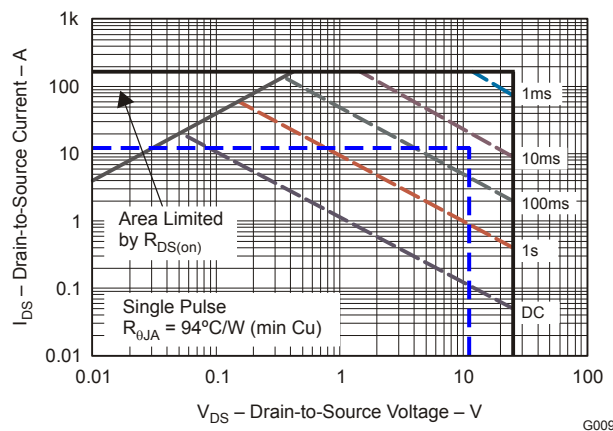

Figure 31. CSD16403Q5 SOA Curve

STEP 4. Calculate the Retry-Mode Duty Ratio

In retry mode, the TPS24701 is on for one charging cycle and off for 16 charge/discharge cycles, as can be seen in Figure 28. The first C_T charging cycle is from 0 V to 1.35 V, which gives 7.56 ms. The first C_T discharging cycle is from 1.35 V to 0.35 V, which gives 5.6 ms. Therefore, the total time is $7.56 \text{ ms} + 33 \times 5.6 \text{ ms} = 192.36 \text{ ms}$. As a result, the retry mode duty ratio is $7.56 \text{ ms} / 192.36 \text{ ms} = 3.93\%$.

STEP 5. Select R1 and R2 for UV

Next, select the values of the UV resistors, R_1 and R_2 , as shown in the application diagram on the front page. From the TPS24700/1 electrical specifications, $V_{\text{ENTHRESH}} = 1.35 \text{ V}$. The V_{UV} is the undervoltage trip voltage, which for this example equals 10.8 V.

$$V_{\text{ENTHRESH}} = \frac{R_2}{R_1 + R_2} \times V_{\text{VCC}} \quad (8)$$

Assume R_1 is 130 k Ω and use Equation 8 to solve for the R_2 value of 18.7 k Ω .

STEP 6. Choose R_GATE, R_4 and C_1

In the application diagram on the front page, the gate resistor, R_{GATE} , is intended to suppress high-frequency oscillations. A resistor of 10 Ω serves for most applications, but if M1 has a C_{ISS} below 200 pF, then 33 Ω is recommended. Applications with larger MOSFETs and very short wiring may not require R_{GATE} . R_4 is required only if PGb is used; this resistor serves as a pullup for the open-drain output driver. The current sunk by PGb pin should not exceed 2 mA. C_1 is a bypass capacitor to help control transient voltages, unit emissions, and local supply noise while in the disabled state. Where acceptable, a value in the range of 0.001 μF to 0.1 μF is recommended.

ALTERNATIVE DESIGN EXAMPLE: GATE CAPACITOR (dV/dt) CONTROL IN INRUSH MODE

The TPS24700/1 can be used in applications that expect a constant inrush current. This current is controlled by a capacitor connected from the GATE terminal to GND. A resistor of 1 kΩ placed in series with this capacitor prevents it from slowing a fast-turnoff event. In this mode of operation, M1 operates as a source follower, and the slew rate of the output voltage approximately equals the slew rate of the gate voltage (see Figure 32).

To implement a constant-inrush-current circuit, choose the time to charge, Δt , using Equation 9,

$$\Delta t = \frac{C_{OUT} \times V_{VCC}}{I_{CHG}} \quad (9)$$

where C_{OUT} is the output capacitance, V_{VCC} is the input voltage, and I_{CHG} is the desired C_{OUT} charge current.

To select the gate capacitance use Equation 10.

$$C_{GATE} = \left(I_{GATE} \times \frac{\Delta t}{V_{VCC}} \right) - C_{ISS} \quad (10)$$

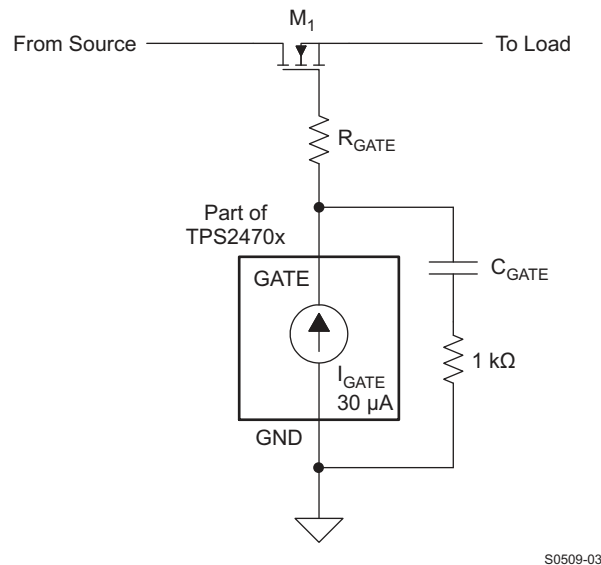

Figure 32. Gate Capacitor (dV/dt) Control Inrush Mode

ADDITIONAL DESIGN CONSIDERATIONS

Use of PGB

Use the PGB pin to control and coordinate a downstream dc/dc converter. If this is not done, then a long time delay is needed to allow C_{OUT} to fully charge before the converter starts. An undesirable latch-up condition can be created between the TPS24700/1 output characteristic and the dc/dc converter input characteristic if the converter starts while C_{OUT} is still charging; the PGB pin is one way to avoid this.

Output Clamp Diode

Inductive loads on the output may drive the OUT pin below GND when the circuit is unplugged or during a current-limit event. The OUT pin ratings can be satisfied by connecting a diode from OUT to GND. The diode should be selected to control the negative voltage at the full short-circuit current. Schottky diodes are generally recommended for this application.

Gate Clamp Diode

The TPS24700/1 has a relatively well-regulated gate voltage of 12 V to 15.5 V with a supply voltage V_{VCC} higher than 4 V. A small clamp Zener from gate to source of M1 is recommended. A series resistance of several hundred ohms or a series silicon diode is recommended to prevent the output capacitance from discharging through the gate driver to ground.

High-Gate-Capacitance Applications

Gate voltage overstress and abnormally large fault current spikes can be caused by large gate capacitance. An external gate clamp Zener diode is recommended to assist the internal Zener if the total gate capacitance of M1 exceeds about 4000 pF. When gate capacitor dV/dt control is used, a 1-k Ω resistor in series with C_G is recommended. If the series R-C combination is used for MOSFETs with C_{ISS} less than 3000 pF, then a Zener is not necessary.

Bypass Capacitors

It is a good practice to provide low-impedance ceramic capacitor bypassing of the VCC and OUT pins. Values in the range of 10 nF to 1 μ F are recommended. Some system topologies are insensitive to the values of these capacitors; however, some are not and require minimization of the value of the bypass capacitor. Input capacitance on a plug-in board may cause a large inrush current as the capacitor charges through the low-impedance power bus when inserted. This stresses the connector contacts and causes a brief voltage sag on the input bus. Small amounts of capacitance (e.g., 10 nF to 0.1 μ F) are often tolerable in these systems.

Output Short-Circuit Measurements

Repeatable short-circuit testing results are difficult to obtain. The many details of source bypassing, input leads, circuit layout and component selection, output shorting method, relative location of the short, and instrumentation all contribute to variation in results. The actual short itself exhibits a certain degree of randomness as it microscopically bounces and arcs. Care in configuration and methods must be used to obtain realistic results. Do not expect to see waveforms exactly like those in the data sheet; every setup differs.

Layout Considerations

TPS24700/1 applications require careful attention to layout to ensure proper performance and to minimize susceptibility to transients and noise. In general, all traces should be as short as possible, but the following list deserves first consideration:

- Decoupling capacitors on VCC pin should have minimal trace lengths to the pin and to GND.
- Traces to VCC and SENSE must be short and run side-by-side to maximize common-mode rejection. Kelvin connections should be used at the points of contact with R_{SENSE}. (see [Figure 33](#)).
- Power path connections should be as short as possible and sized to carry at least twice the full load current, more if possible.
- The device dissipates low power, so soldering the thermal pad to the board is not a requirement. However, doing so improves thermal performance and reduces susceptibility to noise.
- Protection devices such as snubbers, TVS, capacitors, or diodes should be placed physically close to the device they are intended to protect, and routed with short traces to reduce inductance. For example, the protection Schottky diode shown in the application diagram on the front page of the data sheet should be physically close to the OUT pin.

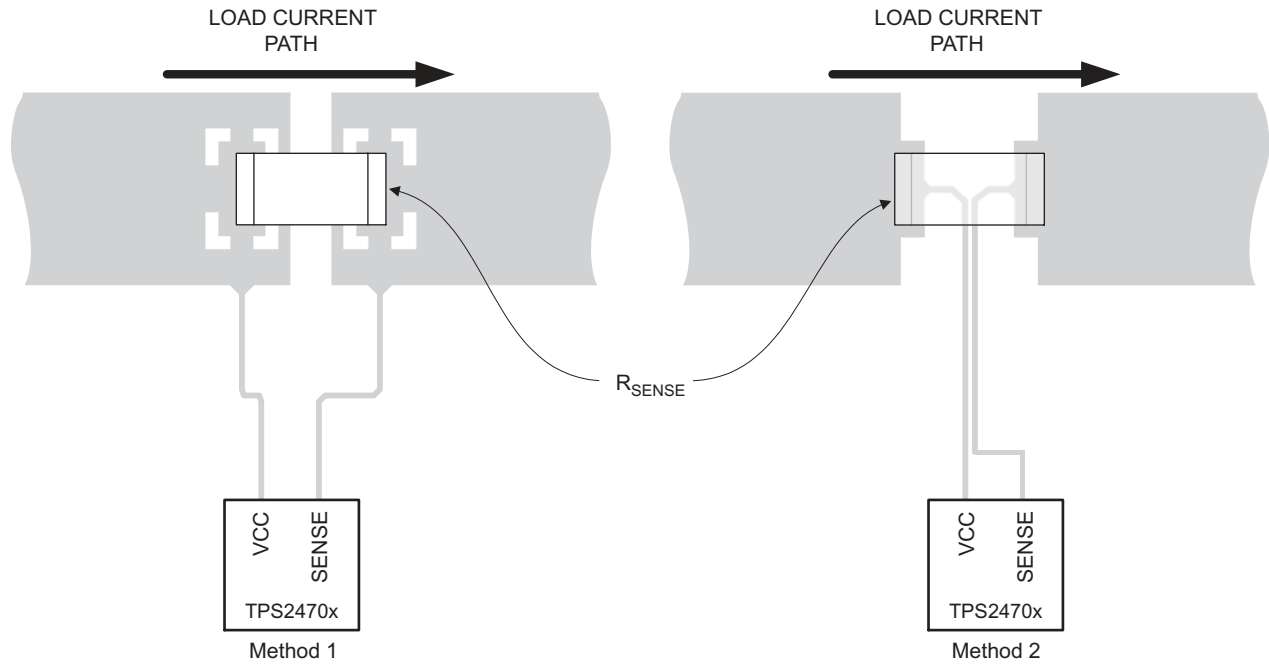

M0217-03

Figure 33. Recommended R_{SENSE} Layout

REVISION HISTORY

Changes from Revision Original (April 2011) to Revision A **Page**

- Revised voltage values shown in the block diagram [5](#)

Changes from Revision A (April 2011) to Revision B **Page**

- Changed in DETAILED PIN DESCRIPTIONS - **PGb**: from 140mV / 340mV to 170mV / 240 mV [6](#)

PACKAGING INFORMATION

Orderable Device	Status (1)	Package Type	Package Drawing	Pins	Package Qty	Eco Plan (2)	Lead finish/ Ball material (6)	MSL Peak Temp (3)	Op Temp (°C)	Device Marking (4/5)	Samples
TPS24700DGK	ACTIVE	VSSOP	DGK	8	80	RoHS & Green	NIPDAU NIPDAUAG	Level-1-260C-UNLIM	-40 to 85	24700	Samples
TPS24700DGKR	ACTIVE	VSSOP	DGK	8	2500	RoHS & Green	NIPDAU NIPDAUAG	Level-1-260C-UNLIM	-40 to 85	24700	Samples
TPS24701DGK	ACTIVE	VSSOP	DGK	8	80	RoHS & Green	NIPDAU NIPDAUAG	Level-1-260C-UNLIM	-40 to 85	24701	Samples
TPS24701DGKR	ACTIVE	VSSOP	DGK	8	2500	RoHS & Green	NIPDAU NIPDAUAG	Level-1-260C-UNLIM	-40 to 85	24701	Samples

(1) The marketing status values are defined as follows:

ACTIVE: Product device recommended for new designs.

LIFEBUY: TI has announced that the device will be discontinued, and a lifetime-buy period is in effect.

NRND: Not recommended for new designs. Device is in production to support existing customers, but TI does not recommend using this part in a new design.

PREVIEW: Device has been announced but is not in production. Samples may or may not be available.

OBSELETE: TI has discontinued the production of the device.

(2) **RoHS:** TI defines "RoHS" to mean semiconductor products that are compliant with the current EU RoHS requirements for all 10 RoHS substances, including the requirement that RoHS substance do not exceed 0.1% by weight in homogeneous materials. Where designed to be soldered at high temperatures, "RoHS" products are suitable for use in specified lead-free processes. TI may reference these types of products as "Pb-Free".

RoHS Exempt: TI defines "RoHS Exempt" to mean products that contain lead but are compliant with EU RoHS pursuant to a specific EU RoHS exemption.

Green: TI defines "Green" to mean the content of Chlorine (Cl) and Bromine (Br) based flame retardants meet JS709B low halogen requirements of <=1000ppm threshold. Antimony trioxide based flame retardants must also meet the <=1000ppm threshold requirement.

(3) MSL, Peak Temp. - The Moisture Sensitivity Level rating according to the JEDEC industry standard classifications, and peak solder temperature.

(4) There may be additional marking, which relates to the logo, the lot trace code information, or the environmental category on the device.

(5) Multiple Device Markings will be inside parentheses. Only one Device Marking contained in parentheses and separated by a "-" will appear on a device. If a line is indented then it is a continuation of the previous line and the two combined represent the entire Device Marking for that device.

(6) Lead finish/Ball material - Orderable Devices may have multiple material finish options. Finish options are separated by a vertical ruled line. Lead finish/Ball material values may wrap to two lines if the finish value exceeds the maximum column width.

Important Information and Disclaimer:The information provided on this page represents TI's knowledge and belief as of the date that it is provided. TI bases its knowledge and belief on information provided by third parties, and makes no representation or warranty as to the accuracy of such information. Efforts are underway to better integrate information from third parties. TI has taken and

continues to take reasonable steps to provide representative and accurate information but may not have conducted destructive testing or chemical analysis on incoming materials and chemicals. TI and TI suppliers consider certain information to be proprietary, and thus CAS numbers and other limited information may not be available for release.

In no event shall TI's liability arising out of such information exceed the total purchase price of the TI part(s) at issue in this document sold by TI to Customer on an annual basis.

TAPE AND REEL INFORMATION

QUADRANT ASSIGNMENTS FOR PIN 1 ORIENTATION IN TAPE

*All dimensions are nominal

Device	Package Type	Package Drawing	Pins	SPQ	Reel Diameter (mm)	Reel Width W1 (mm)	A0 (mm)	B0 (mm)	K0 (mm)	P1 (mm)	W (mm)	Pin1 Quadrant
TPS24700DGKR	VSSOP	DGK	8	2500	330.0	12.4	5.3	3.4	1.4	8.0	12.0	Q1
TPS24700DGKR	VSSOP	DGK	8	2500	330.0	12.4	5.3	3.4	1.4	8.0	12.0	Q1
TPS24701DGKR	VSSOP	DGK	8	2500	330.0	12.4	5.3	3.4	1.4	8.0	12.0	Q1
TPS24701DGKR	VSSOP	DGK	8	2500	330.0	12.4	5.3	3.4	1.4	8.0	12.0	Q1

TAPE AND REEL BOX DIMENSIONS

*All dimensions are nominal

Device	Package Type	Package Drawing	Pins	SPQ	Length (mm)	Width (mm)	Height (mm)
TPS24700DGKR	VSSOP	DGK	8	2500	364.0	364.0	27.0
TPS24700DGKR	VSSOP	DGK	8	2500	358.0	335.0	35.0
TPS24701DGKR	VSSOP	DGK	8	2500	358.0	335.0	35.0
TPS24701DGKR	VSSOP	DGK	8	2500	364.0	364.0	27.0

TUBE

*All dimensions are nominal

Device	Package Name	Package Type	Pins	SPQ	L (mm)	W (mm)	T (μm)	B (mm)
TPS24700DGK	DGK	VSSOP	8	80	330	6.55	500	2.88
TPS24701DGK	DGK	VSSOP	8	80	330	6.55	500	2.88



- NOTES:
- A. All linear dimensions are in millimeters.
 - B. This drawing is subject to change without notice.
 - C. Publication IPC-7351 is recommended for alternate designs.
 - D. Laser cutting apertures with trapezoidal walls and also rounding corners will offer better paste release. Customers should contact their board assembly site for stencil design recommendations. Refer to IPC-7525 for other stencil recommendations.
 - E. Customers should contact their board fabrication site for solder mask tolerances between and around signal pads.

IMPORTANT NOTICE AND DISCLAIMER

TI PROVIDES TECHNICAL AND RELIABILITY DATA (INCLUDING DATA SHEETS), DESIGN RESOURCES (INCLUDING REFERENCE DESIGNS), APPLICATION OR OTHER DESIGN ADVICE, WEB TOOLS, SAFETY INFORMATION, AND OTHER RESOURCES "AS IS" AND WITH ALL FAULTS, AND DISCLAIMS ALL WARRANTIES, EXPRESS AND IMPLIED, INCLUDING WITHOUT LIMITATION ANY IMPLIED WARRANTIES OF MERCHANTABILITY, FITNESS FOR A PARTICULAR PURPOSE OR NON-INFRINGEMENT OF THIRD PARTY INTELLECTUAL PROPERTY RIGHTS.

These resources are intended for skilled developers designing with TI products. You are solely responsible for (1) selecting the appropriate TI products for your application, (2) designing, validating and testing your application, and (3) ensuring your application meets applicable standards, and any other safety, security, regulatory or other requirements.

These resources are subject to change without notice. TI grants you permission to use these resources only for development of an application that uses the TI products described in the resource. Other reproduction and display of these resources is prohibited. No license is granted to any other TI intellectual property right or to any third party intellectual property right. TI disclaims responsibility for, and you will fully indemnify TI and its representatives against, any claims, damages, costs, losses, and liabilities arising out of your use of these resources.

TI's products are provided subject to [TI's Terms of Sale](#) or other applicable terms available either on ti.com or provided in conjunction with such TI products. TI's provision of these resources does not expand or otherwise alter TI's applicable warranties or warranty disclaimers for TI products.

TI objects to and rejects any additional or different terms you may have proposed.

Mailing Address: Texas Instruments, Post Office Box 655303, Dallas, Texas 75265
Copyright © 2022, Texas Instruments Incorporated