

HIGH POWER SPDT SWITCH GaAs MMIC

■ GENERAL DESCRIPTION

The NJG1814MD7 is a GaAs SPDT switch MMIC suitable for WLAN, LTE and 4G applications.

The NJG1814MD7 features very high isolation, low insertion loss, and excellent linearity performance at high frequency up to 6GHz. In addition, its high speed switching time is available for WLAN application. Integrated ESD protection device on each port achieves excellent ESD robustness. No DC blocking capacitors are required for all RF ports unless DC is biased externally.

The small and thin EQFN14-D7 package is adopted.

■ PACKAGE OUTLINE

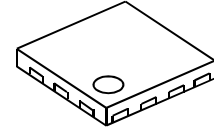

NJG1814MD7

■ APPLICATIONS

- IEEE 802.11a/b/g/n/ac applications
- LTE and LTE-U applications
- General Purpose Switching applications

■ FEATURES

- Low voltage logic control 1.35V to 5.0V
- High Isolation 42dB typ. @f=0.7GHz, P_{IN}=+27dBm
35dB typ. @f=2.0GHz, P_{IN}=+27dBm
34dB typ. @f=2.7GHz, P_{IN}=+27dBm
33dB typ. @f=5.85GHz, P_{IN}=+27dBm
- Low insertion loss 0.35dB typ. @f=0.7GHz, P_{IN}=+27dBm
0.38dB typ. @f=2.0GHz, P_{IN}=+27dBm
0.40dB typ. @f=2.7GHz, P_{IN}=+27dBm
0.45dB typ. @f=5.85GHz, P_{IN}=+27dBm
+33dBm min.
- P_{-0.1dB} 200ns typ.
- High speed switching time EQFN14-D7 (Package size: 1.6 x 1.6 x 0.397mm)
- Ultra small & thin package
- RoHS compliant and Halogen Free, MSL1

■ PIN CONFIGURATION

(TOP VIEW)

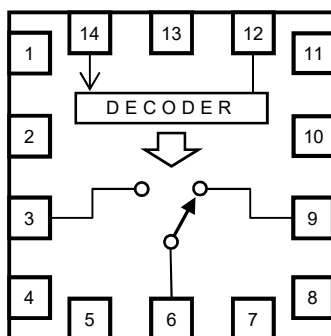

Pin connection

- | | |
|------------|-------------|
| 1. GND | 8. GND |
| 2. NC(GND) | 9. P1 |
| 3. P2 | 10. GND |
| 4. GND | 11. GND |
| 5. GND | 12. VDD |
| 6. PC | 13. NC(GND) |
| 7. GND | 14. VCTL |

Exposed PAD: GND

■ TRUTH TABLE

“H”=V_{CTL(H)}, “L”=V_{CTL(L)}

VCTL	Path
H	PC-P1
L	PC-P2

NOTE: Please note that any information on this datasheet will be subject to change.

■ ABSOLUTE MAXIMUM RATINGS

(General conditions: $T_a=+25^{\circ}\text{C}$, $Z_s=Z_l=50\Omega$)

PARAMETER	SYMBOL	CONDITIONS	RATINGS	UNITS
RF Input Power	P_{IN}	$V_{DD}=3.3\text{V}$	+33.5	dBm
Supply Voltage	V_{DD}		5.0	V
Control Voltage	V_{CTL}		5.0	V
Power Dissipation	P_D	Four-layer FR4 PCB with through-hole (76.2x114.3mm), $T_j=150^{\circ}\text{C}$	1300	mW
Operating Temp.	T_{opr}		-40 to +105	$^{\circ}\text{C}$
Storage Temp.	T_{stg}		-55 to +150	$^{\circ}\text{C}$

■ ELECTRICAL CHARACTERISTICS 1 (DC)

(General conditions: $T_a=+25^{\circ}\text{C}$, $Z_s=Z_l=50\Omega$)

PARAMETERS	SYMBOL	CONDITIONS	MIN	TYP	MAX	UNITS
Supply Voltage	V_{DD}		2.5	3.3	5.0	V
Operating Current	I_{DD}	No RF input, $V_{DD}=3.3\text{V}$	-	200	400	μA
Control Voltage (LOW)	$V_{CTL(L)}$		0	-	0.45	V
Control Voltage (HIGH)	$V_{CTL(H)}$		1.35	1.8	5.0	V
Control Current	I_{CTL}	$V_{CTL(H)}=1.8\text{V}$	-	4	10	μA

■ ELECTRICAL CHARACTERISTICS 2 (RF)

(General conditions: $T_a=+25^{\circ}\text{C}$, $Z_s=Z_l=50\Omega$, $V_{DD}=3.3\text{V}$, $V_{CTL(L)}=0\text{V}$, $V_{CTL(H)}=1.8\text{V}$, with application circuit)

PARAMETERS	SYMBOL	CONDITIONS	MIN	TYP	MAX	UNITS	
Insertion Loss 1	LOSS1	$f=0.7\text{GHz}$, $P_{IN}=+27\text{dBm}$	-	0.35	0.50	dB	
Insertion Loss 2	LOSS2	$f=2.0\text{GHz}$, $P_{IN}=+27\text{dBm}$	-	0.38	0.53	dB	
Insertion Loss 3	LOSS3	$f=2.7\text{GHz}$, $P_{IN}=+27\text{dBm}$	-	0.40	0.60	dB	
Insertion Loss 4	LOSS4	$f=3.5\text{GHz}$, $P_{IN}=+27\text{dBm}$	-	0.42	0.62	dB	
Insertion Loss 5	LOSS5	$f=5.85\text{GHz}$, $P_{IN}=+27\text{dBm}$	-	0.45	0.65	dB	
Isolation 1	ISL1	$f=0.7\text{GHz}$, $P_{IN}=+27\text{dBm}$	39	42	-	dB	
Isolation 2	ISL2	$f=2.0\text{GHz}$, $P_{IN}=+27\text{dBm}$	32	35	-	dB	
Isolation 3	ISL3	$f=2.7\text{GHz}$, $P_{IN}=+27\text{dBm}$	31	34	-	dB	
Isolation 4	ISL4	$f=3.5\text{GHz}$, $P_{IN}=+27\text{dBm}$	30	33	-	dB	
Isolation 5	ISL5	$f=5.85\text{GHz}$ $P_{IN}=+27\text{dBm}$	PC- P_n^{*1}	30	33	-	dB
			$P_m-P_n^{*2}$	25	27	-	dB
Input Power at 0.1dB Compression Point	$P_{-0.1\text{dB}}$	$f=5.85\text{GHz}$	+33	-	-	dBm	
2nd Harmonics	$2f_0$	$f=5.18\text{GHz}$, 5.85GHz , $P_{IN}=+27\text{dBm}$	-	-	-70	dBc	
3rd Harmonics	$3f_0$	$f=5.18\text{GHz}$, 5.85GHz , $P_{IN}=+27\text{dBm}$	-	-	-70	dBc	
4th Harmonics	$4f_0$	$f=5.18\text{GHz}$, 5.85GHz , $P_{IN}=+27\text{dBm}$	-	-	-70	dBc	
Input 2nd order intercept point	IIP2	$f=2.48+2.69\text{GHz}$, $f_{\text{meas}}=5.17\text{GHz}$, $P_{IN}=+10\text{dBm}$ each	+100	-	-	dBm	
Input 3rd order intercept point	IIP3	$f=1.71+2.40\text{GHz}$, $f_{\text{meas}}=5.82\text{GHz}$, $P_{IN}=+10\text{dBm}$ each	+60	-	-	dBm	
VSWR1	VSWR1	On-state ports, $f=2.7\text{GHz}$	-	1.1	1.5		
VSWR2	VSWR2	On-state ports, $f=5.85\text{GHz}$	-	1.1	1.5		
Switching time	T_{SW}	50% V_{CTL} to 10/90% RF	-	200	400	ns	

*1: $P_n=P_1, P_2$.

*2: $P_m=P_1, P_2$. $P_n=P_1, P_2$. $m \neq n$

■ TERMINAL INFORMATION

No.	SYMBOL	DESCRIPTION
1	GND	Ground terminal. Please connect this terminal with ground plane as close as possible for excellent RF performance.
2	NC(GND)	No connected terminal. Please connect this terminal with ground plane as close as possible for excellent RF performance.
3	P2	RF transmitting/receiving port. No DC blocking capacitor is required for this port unless DC is biased externally.
4	GND	Ground terminal. Please connect this terminal with ground plane as close as possible for excellent RF performance.
5	GND	Ground terminal. Please connect this terminal with ground plane as close as possible for excellent RF performance.
6	PC	RF transmitting/receiving port. No DC blocking capacitor is required for this port unless DC is biased externally. Please connect an inductor with GND terminal for ESD protection.
7	GND	Ground terminal. Please connect this terminal with ground plane as close as possible for excellent RF performance.
8	GND	Ground terminal. Please connect this terminal with ground plane as close as possible for excellent RF performance.
9	P1	RF transmitting/receiving port. No DC blocking capacitor is required for this port unless DC is biased externally.
10	GND	Ground terminal. Please connect this terminal with ground plane as close as possible for excellent RF performance.
11	GND	Ground terminal. Please connect this terminal with ground plane as close as possible for excellent RF performance.
12	VDD	Positive voltage supply terminal. The positive voltage (+2.5 to +5V) has to be supplied. Please connect a bypass capacitor with GND terminal for excellent RF performance.
13	NC(GND)	No connected terminal. Please connect this terminal with ground plane as close as possible for excellent RF performance.
14	VCTL	Control signal input terminal. This terminal is set to High-Level (+1.35 to +5.0V) or Low-Level (0 to +0.45V).
Exposed Pad	GND	Ground terminal. Please connect this terminal with ground plane as close as possible for excellent RF performance.

■ ELECTRICAL CHARACTERISTICS (With application circuit, loss of external circuit are excluded.)

Loss, ISL vs. Frequency

(PC-P1 ON, $V_{DD} = 3.3V$, $V_{CTL(H)} = 1.8V$)

(Losses of external circuits are excluded)

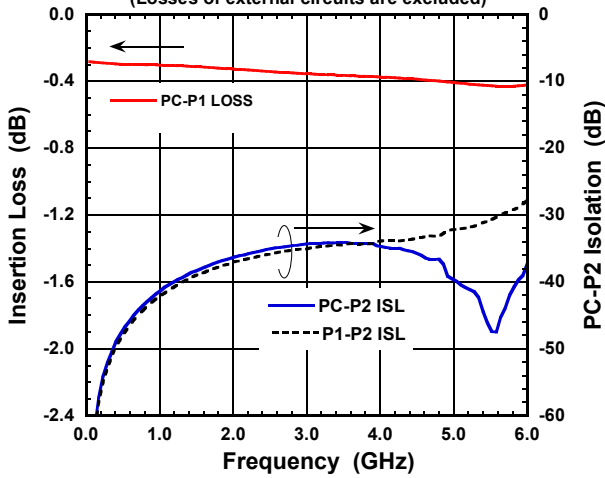

Loss, ISL vs. Frequency

(PC-P2 ON, $V_{DD} = 3.3V$, $V_{CTL(L)} = 0V$)

(Losses of external circuits are excluded)

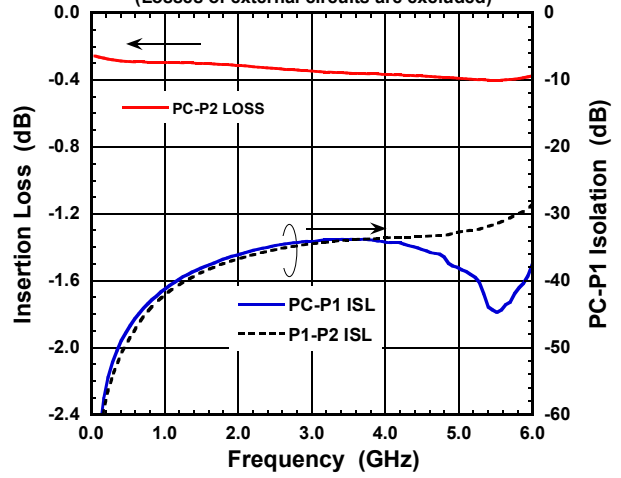

Loss, ISL vs. Input Power

($f = 0.7GHz$, PC-P1 ON, $V_{CTL(H)} = 1.8V$)

(Losses of external circuits are excluded)

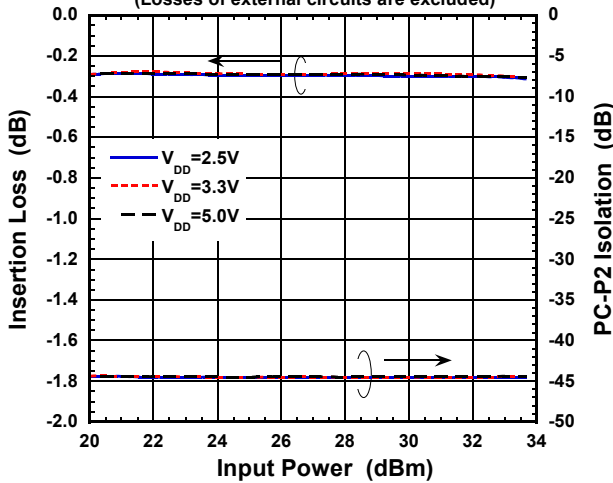

Loss, ISL vs. Input Power

($f = 2.0GHz$, PC-P1 ON, $V_{CTL(H)} = 1.8V$)

(Losses of external circuits are excluded)

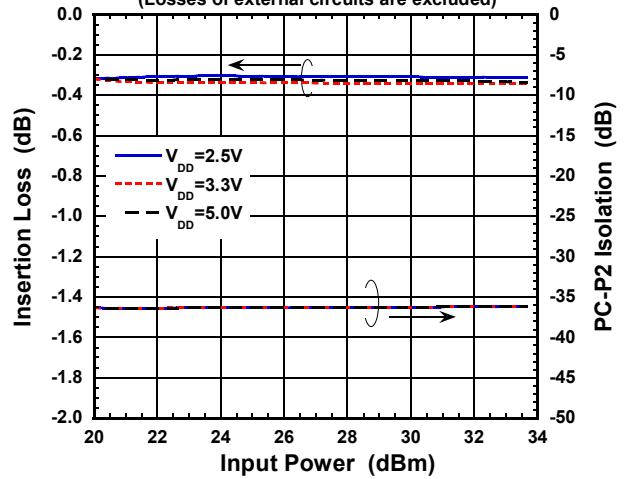

Loss, ISL vs. Input Power

($f = 2.7GHz$, PC-P1 ON, $V_{CTL(H)} = 1.8V$)

(Losses of external circuits are excluded)

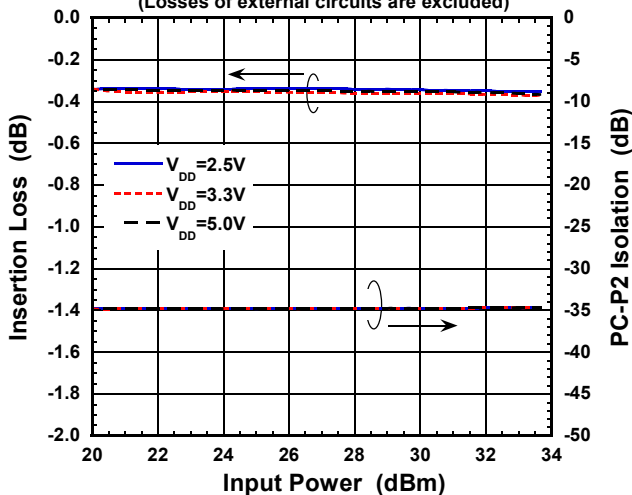

Loss, ISL vs. Input Power

($f = 3.5GHz$, PC-P1 ON, $V_{CTL(H)} = 1.8V$)

(Losses of external circuits are excluded)

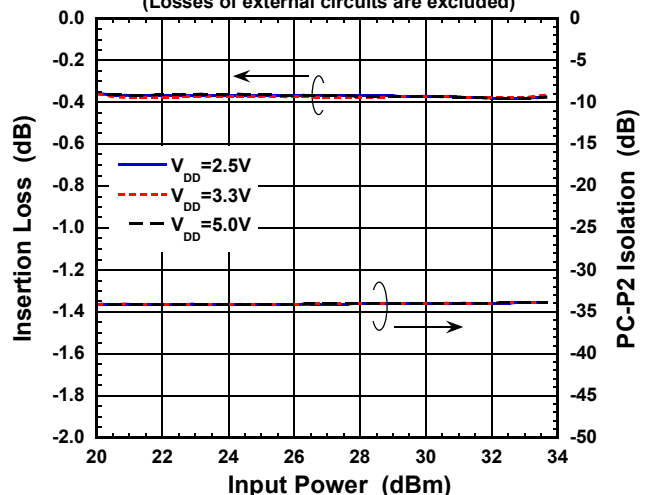

■ ELECTRICAL CHARACTERISTICS (With application circuit, loss of external circuit are excluded.)

Loss, ISL vs. Input Power

(f=5.85GHz, PC-P1 ON, $V_{CTL(H)}=1.8V$)

(Losses of external circuits are excluded)

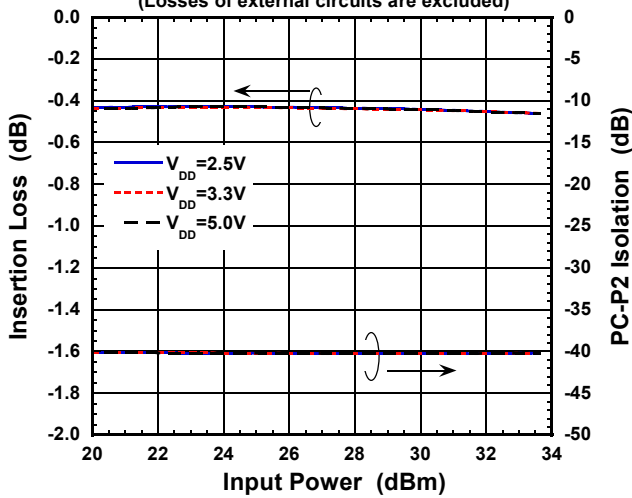

Output Power, I_{DD} vs. Input Power

(f=0.7GHz, PC-P1 ON, $V_{CTL(H)}=1.8V$)

(Losses of external circuits are excluded)

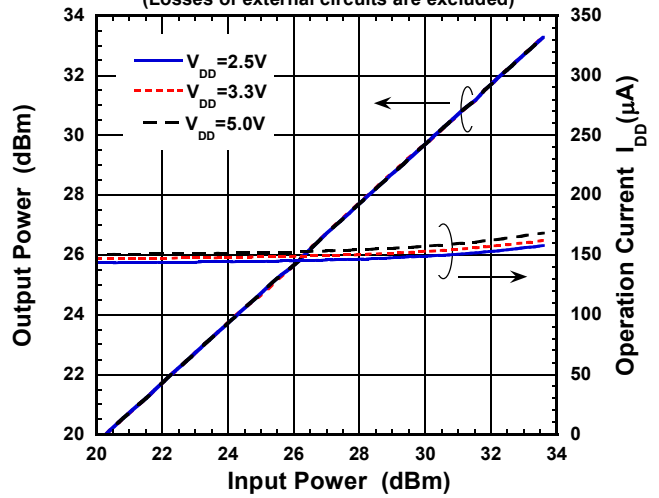

Output Power, I_{DD} vs. Input Power

(f=2.0GHz, PC-P1 ON, $V_{CTL(H)}=1.8V$)

(Losses of external circuits are excluded)

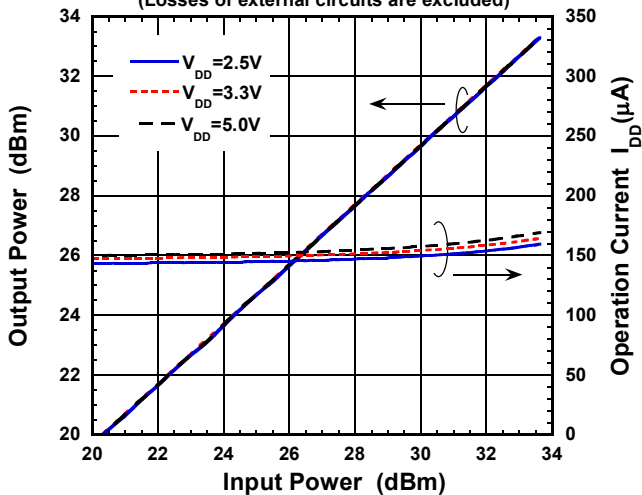

Output Power, I_{DD} vs. Input Power

(f=2.7GHz, PC-P1 ON, $V_{CTL(H)}=1.8V$)

(Losses of external circuits are excluded)

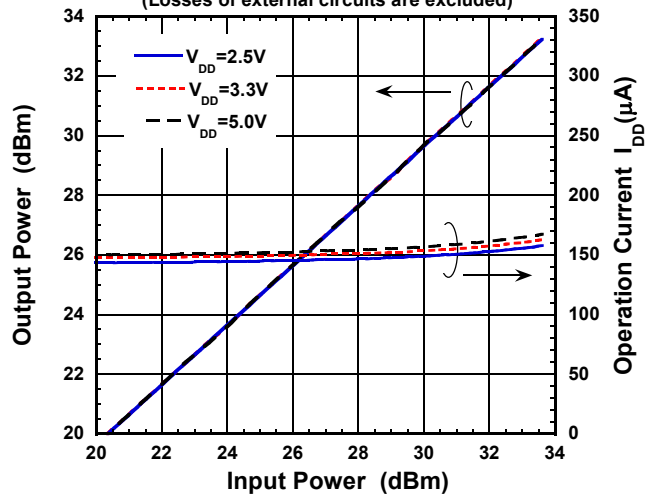

Output Power, I_{DD} vs. Input Power

(f=3.5GHz, PC-P1 ON, $V_{CTL(H)}=1.8V$)

(Losses of external circuits are excluded)

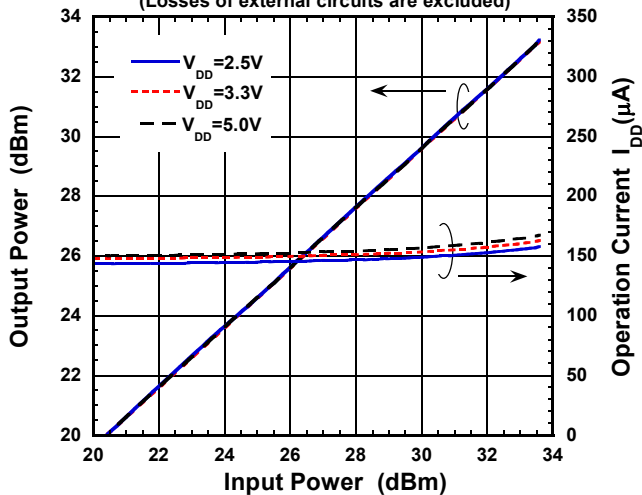

Output Power, I_{DD} vs. Input Power

(f=5.85GHz, PC-P1 ON, $V_{CTL(H)}=1.8V$)

(Losses of external circuits are excluded)

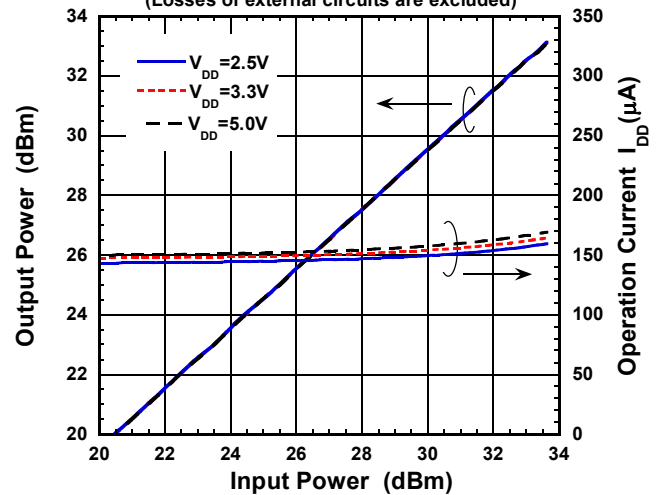

■ ELECTRICAL CHARACTERISTICS (With application circuit, loss of external circuit are excluded.)

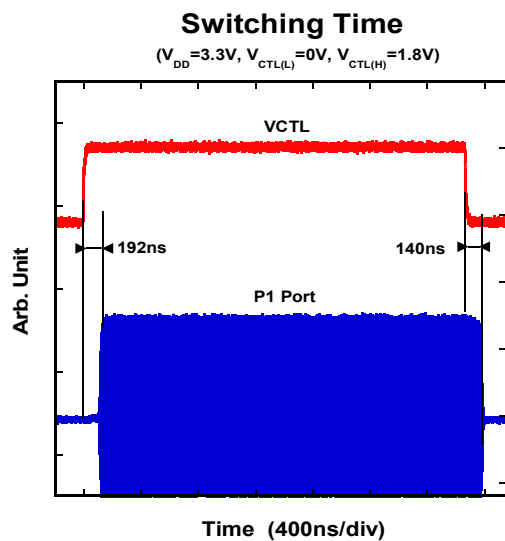
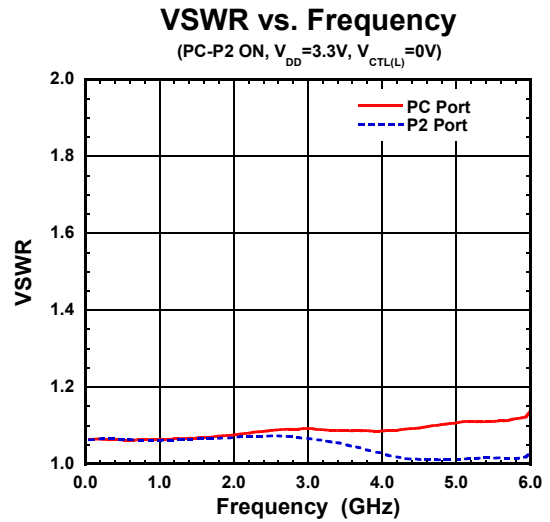
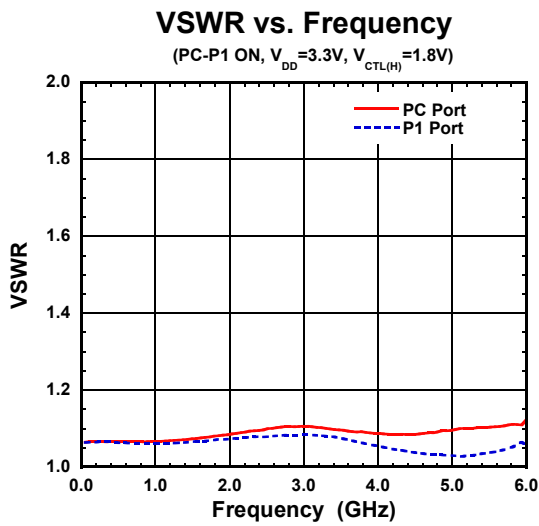
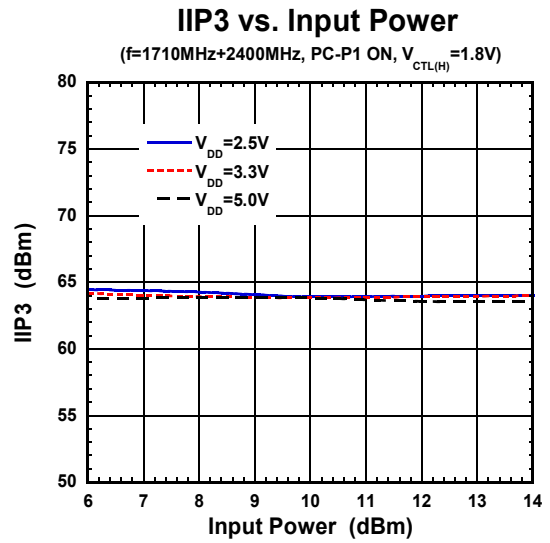
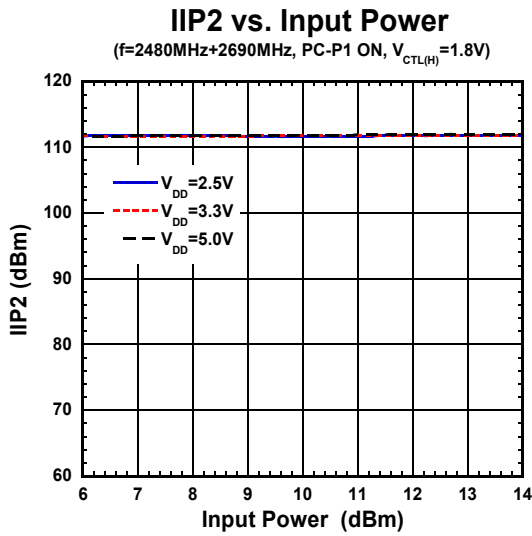

■ ELECTRICAL CHARACTERISTICS (With application circuit, loss of external circuit are excluded.)

Loss, ISL vs. Ambient Temperature

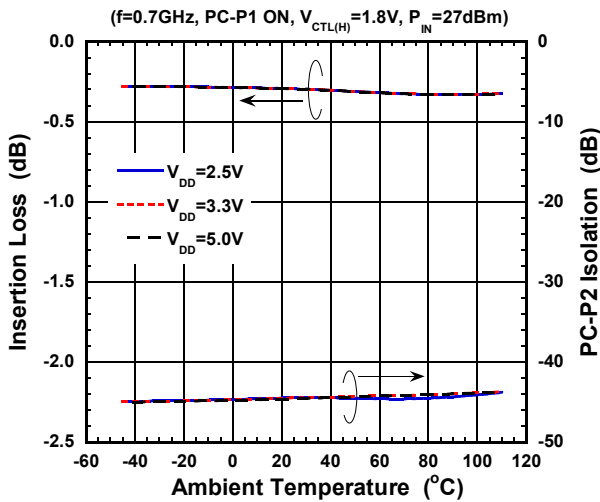

Loss, ISL vs. Ambient Temperature

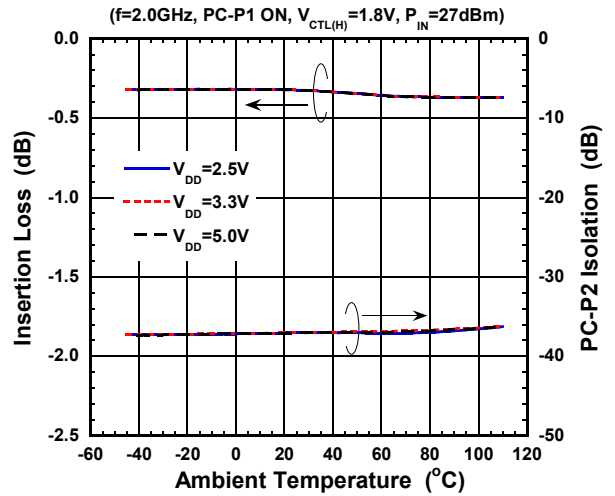

Loss, ISL vs. Ambient Temperature

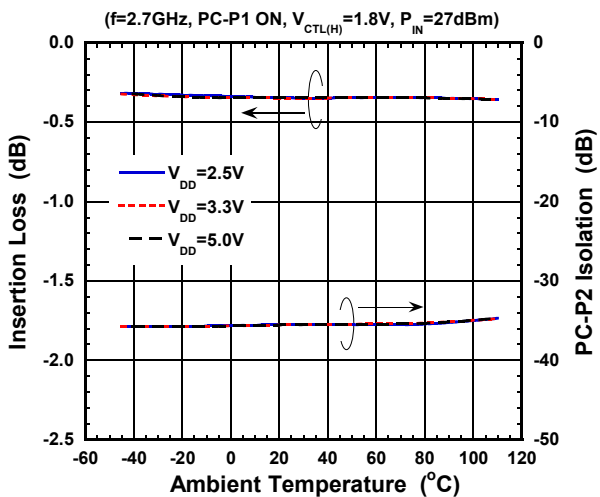

Loss, ISL vs. Ambient Temperature

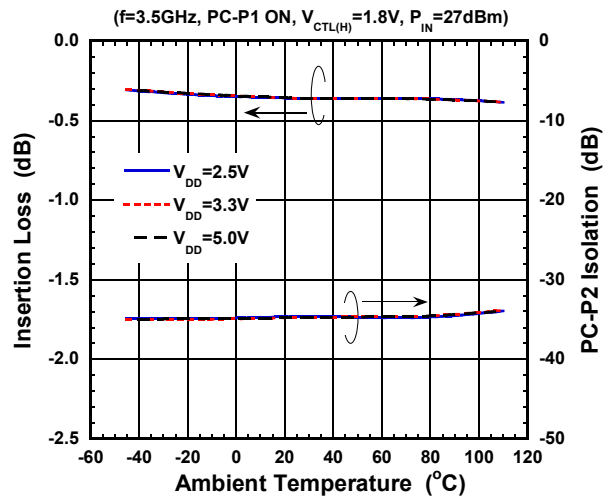

Loss, ISL vs. Ambient Temperature

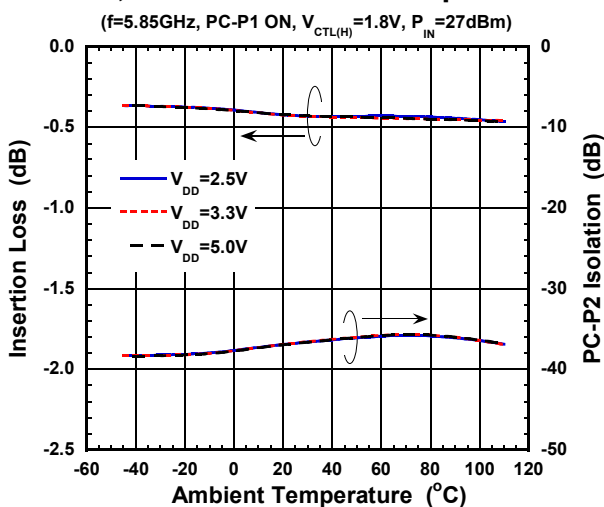

■ ELECTRICAL CHARACTERISTICS (With application circuit, loss of external circuit are excluded.)

VSWR vs Ambient Temperature

(f=5850MHz, PC Port, PC-P1 ON, $V_{CTL(H)}=1.8V$)

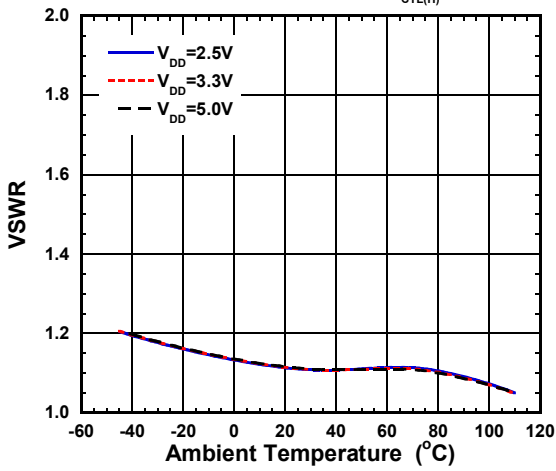

Switching Time vs. Ambient Temperature

($V_{DD}=3.3V$, $V_{CTL(L)}=0V$, $V_{CTL(H)}=1.8V$)

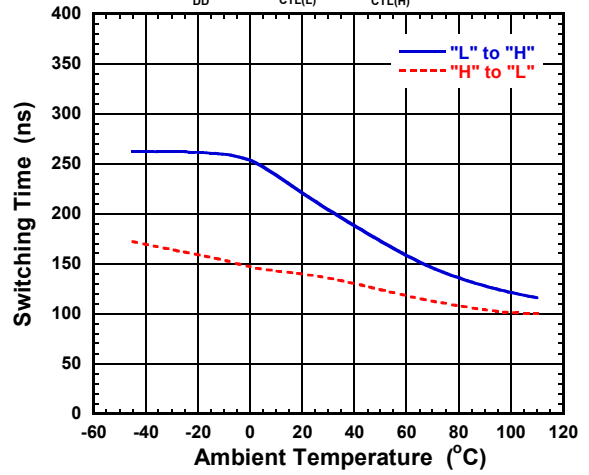

IIP2 vs. Ambient Temperature

(f=2480MHz+2690MHz, PC-P1 ON, $V_{CTL(H)}=1.8V$, $P_{IN}=10dBm$)

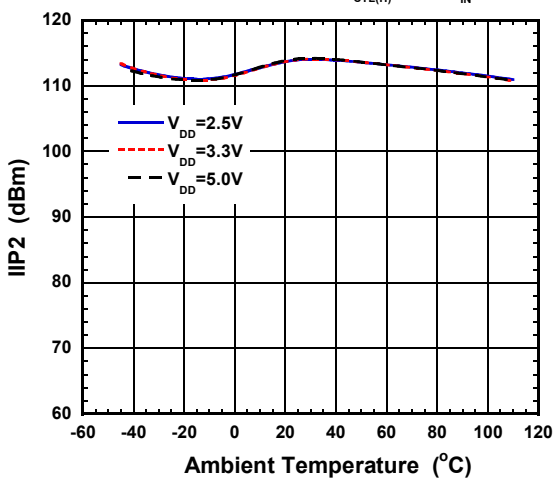

IIP3 vs. Ambient Temperature

(f=1710MHz+2400MHz, PC-P1 ON, $V_{CTL(H)}=1.8V$, $P_{IN}=10dBm$)

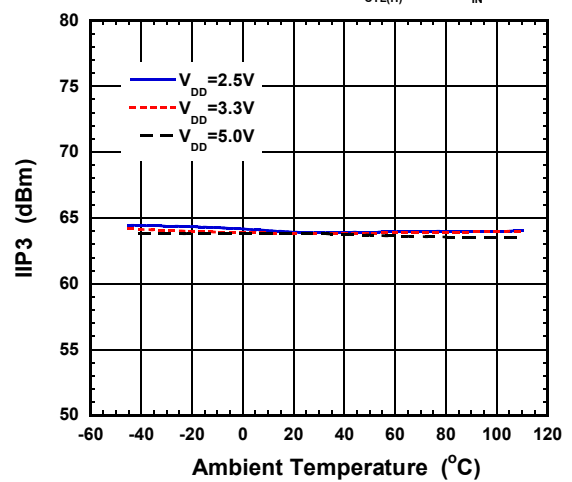

VSWR vs Ambient Temperature

(f=2700MHz, PC Port, PC-P1 ON, $V_{CTL(H)}=1.8V$)

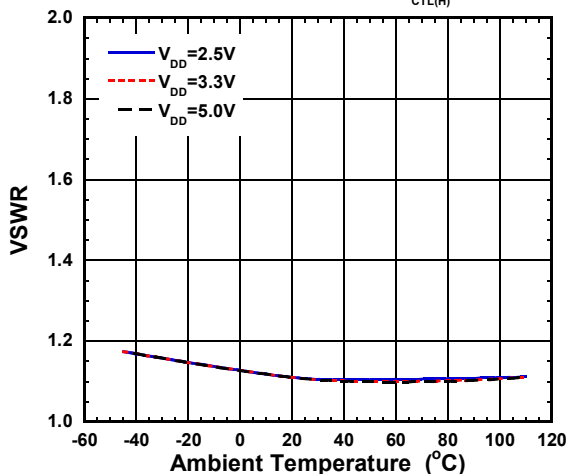

APPLICATION CIRCUIT

(TOP VIEW)

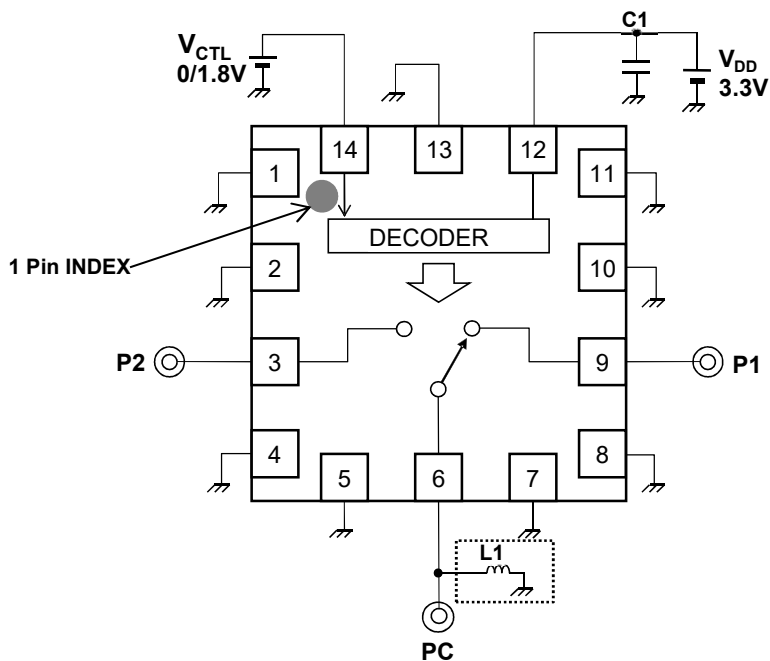

Note:

- [1] No DC blocking capacitors are required on all RF ports, unless DC is biased externally.
- [2] The inductor L1 is optional in order to achieve enhancing ESD protection level.
- [3] L1 is also recommended in order to keep the DC bias level of each RF port at 0V level tightly.

PARTS LIST

No.	Parameters	Note
C1	1000pF	MURATA (GRM15)
L1	56nH	TAIYO-YUDEN (HK1005)

PCB LAYOUT

(TOP VIEW)

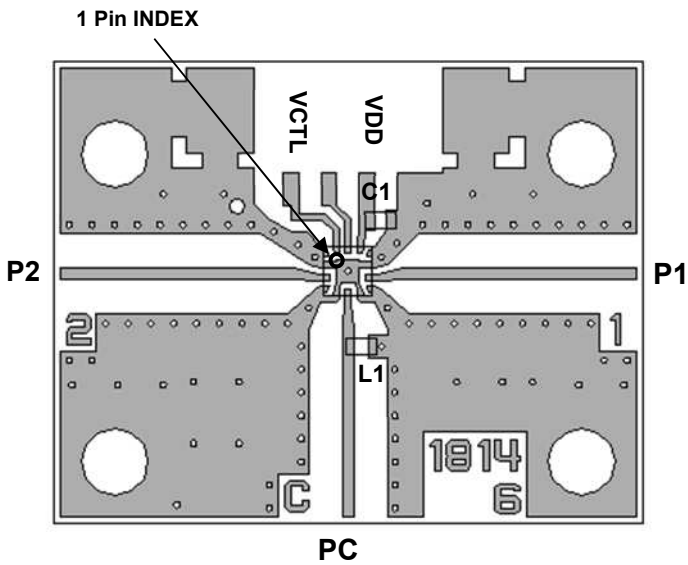

PCB size: 19.4 x 15.0 mm
 PCB: FR-4, t=0.2mm
 Micro strip line width: 0.38mm

Losses of PCB and connectors, Ta=+25°C

Frequency (GHz)	Loss (dB)
0.7	0.18
2.0	0.31
2.7	0.35
3.5	0.42
5.85	0.66

* L1 is optional

PRECAUTIONS

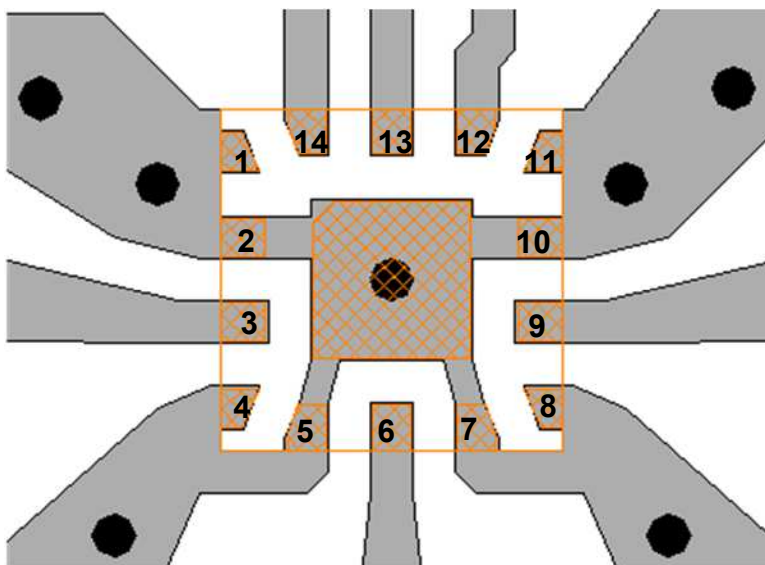

- [1] No DC blocking capacitors are required at each RF port normally. When the other device is biased at certain voltage and connected to the NJG1814MD7, a DC blocking capacitor is required between the device and the switch IC. This is because the each RF port of NJG1814MD7 is biased at 0V (GND).
- [2] For avoiding the degradation of RF performance, the bypass capacitor (C1) should be placed as close as possible to VDD terminal.
- [3] For good RF performance, all GND terminals are must be connected to PCB ground plane of substrate, and through - holes for ground should be placed the IC near.

PCB LAYOUT GUIDELINE (EQFN14-D7)



- PCB
- PKG Terminal
- PKG Outline
- GND Via Hole
Diameter $\phi = 0.2\text{mm}$

RECOMMENDED FOOTPRINT PATTERN (EQFN14-D7 PACKAGE Reference)

-  :Land
-  :Mask (Open area) *Metal mask thickness : 100μm
-  :Resist(Open area)

PKG: 1.6mm x 1.6mm
Pin pitch: 0.4mm

Units : mm

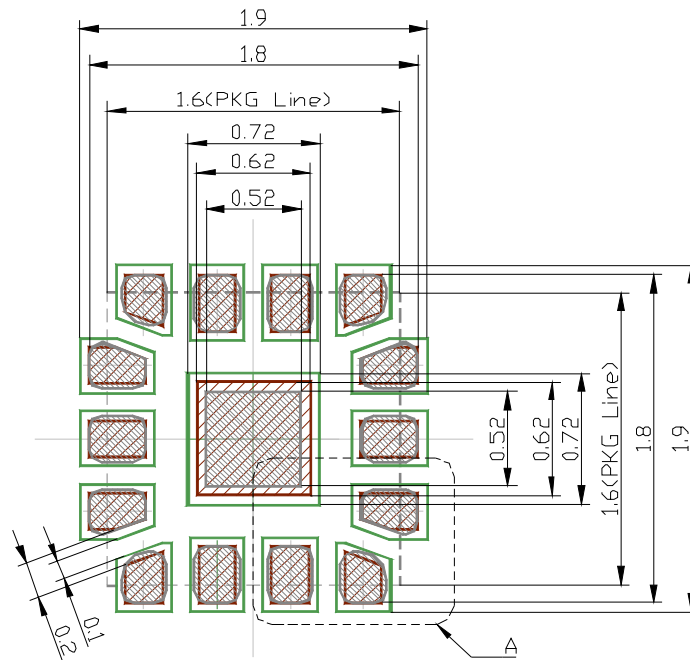

Detail A

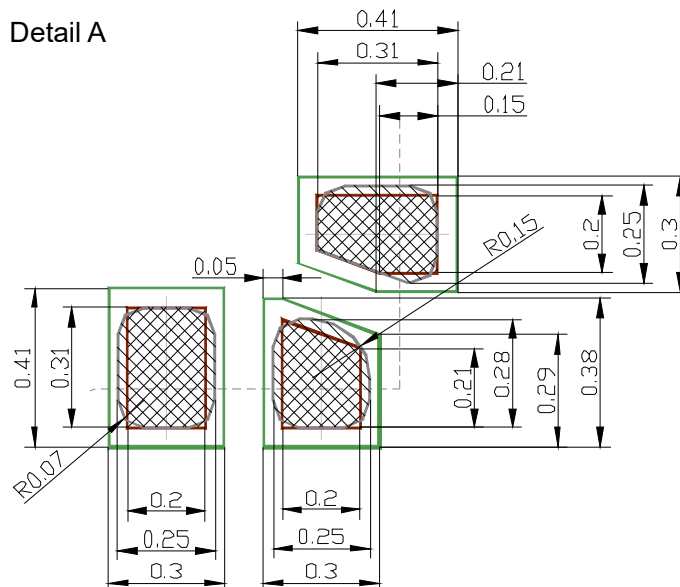

PACKAGE OUTLINE (EQFN14-D7)

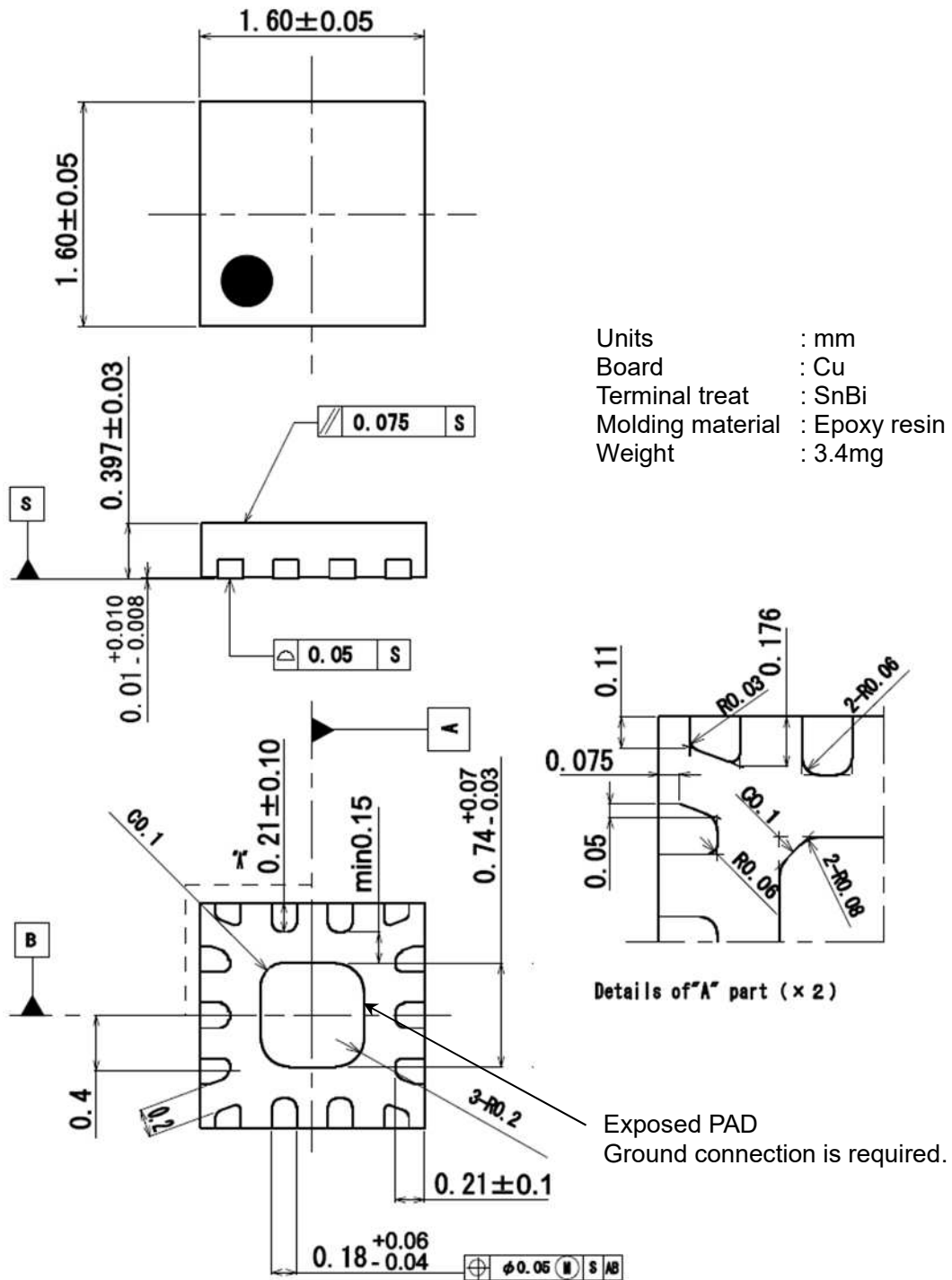

Cautions on using this product

- This product contains Gallium-Arsenide (GaAs) which is a harmful material.
- Do NOT eat or put into mouth.
 - Do NOT dispose in fire or break up this product.
 - Do NOT chemically make gas or powder with this product.
 - To waste this product, please obey the relating law of your country.

[CAUTION]

The specifications on this databook are only given for information, without any guarantee as regards either mistakes or omissions. The application circuits in this databook are described only to show representative usages of the product and not intended for the guarantee or permission of any right including the industrial rights.

This product may be damaged with electric static discharge (ESD) or spike voltage. Please handle with care to avoid these damages.

1. The products and the product specifications described in this document are subject to change or discontinuation of production without notice for reasons such as improvement. Therefore, before deciding to use the products, please refer to our sales representatives for the latest information thereon.
2. The materials in this document may not be copied or otherwise reproduced in whole or in part without the prior written consent of us.
3. This product and any technical information relating thereto are subject to complementary export controls (so-called KNOW controls) under the Foreign Exchange and Foreign Trade Law, and related politics ministerial ordinance of the law. (Note that the complementary export controls are inapplicable to any application-specific products, except rockets and pilotless aircraft, that are insusceptible to design or program changes.) Accordingly, when exporting or carrying abroad this product, follow the Foreign Exchange and Foreign Trade Control Law and its related regulations with respect to the complementary export controls.
4. The technical information described in this document shows typical characteristics and example application circuits for the products. The release of such information is not to be construed as a warranty of or a grant of license under our or any third party's intellectual property rights or any other rights.
5. The products listed in this document are intended and designed for use as general electronic components in standard applications (office equipment, telecommunication equipment, measuring instruments, consumer electronic products, amusement equipment etc.). Those customers intending to use a product in an application requiring extreme quality and reliability, for example, in a highly specific application where the failure or misoperation of the product could result in human injury or death should first contact us.
 - Aerospace Equipment
 - Equipment Used in the Deep Sea
 - Power Generator Control Equipment (nuclear, steam, hydraulic, etc.)
 - Life Maintenance Medical Equipment
 - Fire Alarms / Intruder Detectors
 - Vehicle Control Equipment (automotive, airplane, railroad, ship, etc.)
 - Various Safety Devices
 - Traffic control system
 - Combustion equipment

In case your company desires to use this product for any applications other than general electronic equipment mentioned above, make sure to contact our company in advance. Note that the important requirements mentioned in this section are not applicable to cases where operation requirements such as application conditions are confirmed by our company in writing after consultation with your company.

6. We are making our continuous effort to improve the quality and reliability of our products, but semiconductor products are likely to fail with certain probability. In order to prevent any injury to persons or damages to property resulting from such failure, customers should be careful enough to incorporate safety measures in their design, such as redundancy feature, fire containment feature and fail-safe feature. We do not assume any liability or responsibility for any loss or damage arising from misuse or inappropriate use of the products.
7. The products have been designed and tested to function within controlled environmental conditions. Do not use products under conditions that deviate from methods or applications specified in this datasheet. Failure to employ the products in the proper applications can lead to deterioration, destruction or failure of the products. We shall not be responsible for any bodily injury, fires or accident, property damage or any consequential damages resulting from misuse or misapplication of the products.
8. **Quality Warranty**
 - 8-1. **Quality Warranty Period**

In the case of a product purchased through an authorized distributor or directly from us, the warranty period for this product shall be one (1) year after delivery to your company. For defective products that occurred during this period, we will take the quality warranty measures described in section 8-2. However, if there is an agreement on the warranty period in the basic transaction agreement, quality assurance agreement, delivery specifications, etc., it shall be followed.
 - 8-2. **Quality Warranty Remedies**

When it has been proved defective due to manufacturing factors as a result of defect analysis by us, we will either deliver a substitute for the defective product or refund the purchase price of the defective product.

Note that such delivery or refund is sole and exclusive remedies to your company for the defective product.
 - 8-3. **Remedies after Quality Warranty Period**

With respect to any defect of this product found after the quality warranty period, the defect will be analyzed by us. On the basis of the defect analysis results, the scope and amounts of damage shall be determined by mutual agreement of both parties. Then we will deal with upper limit in Section 8-2. This provision is not intended to limit any legal rights of your company.
9. Anti-radiation design is not implemented in the products described in this document.
10. The X-ray exposure can influence functions and characteristics of the products. Confirm the product functions and characteristics in the evaluation stage.
11. WLCSP products should be used in light shielded environments. The light exposure can influence functions and characteristics of the products under operation or storage.
12. Warning for handling Gallium and Arsenic (GaAs) products (Applying to GaAs MMIC, Photo Reflector). These products use Gallium (Ga) and Arsenic (As) which are specified as poisonous chemicals by law. For the prevention of a hazard, do not burn, destroy, or process chemically to make them as gas or power. When the product is disposed of, please follow the related regulation and do not mix this with general industrial waste or household waste.
13. Please contact our sales representatives should you have any questions or comments concerning the products or the technical information.



Nisshinbo Micro Devices Inc.

Official website

<https://www.nisshinbo-microdevices.co.jp/en/>

Purchase information

<https://www.nisshinbo-microdevices.co.jp/en/buy/>