

Contact Information

**560-P.C. Tail, Make Before Break(MBB) - Tail LG.=.190(4.83)
 .100" (2.54mm) Contact Spacing x .200" (5.08mm) Row Spacing**

THIS IS A C.A.D. GENERATED DRAWING
 DO NOT MAKE MANUAL REVISIONS TO MASTER.



ISSUE NUMBER

ORIGINAL ①

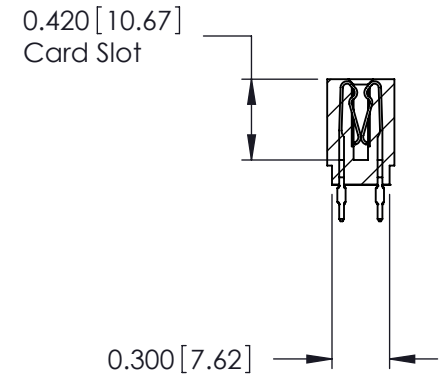
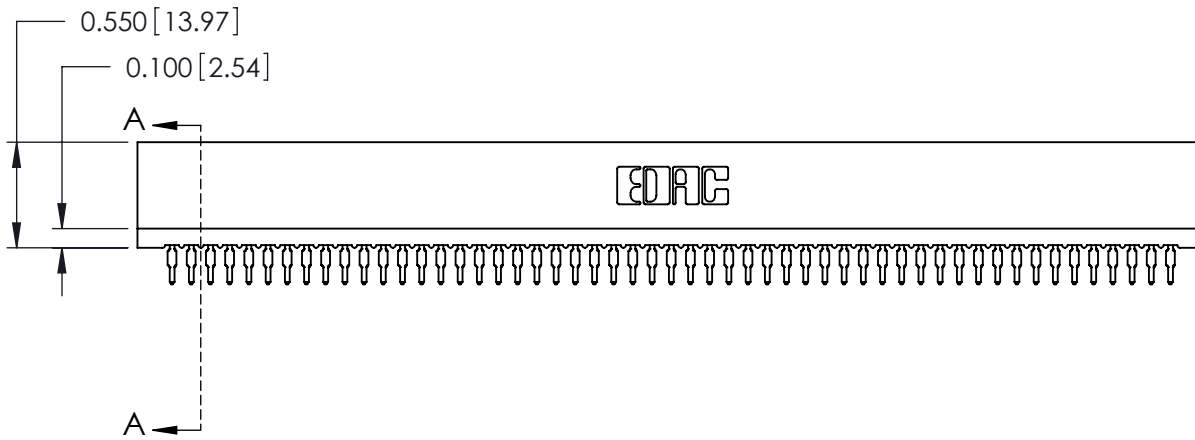
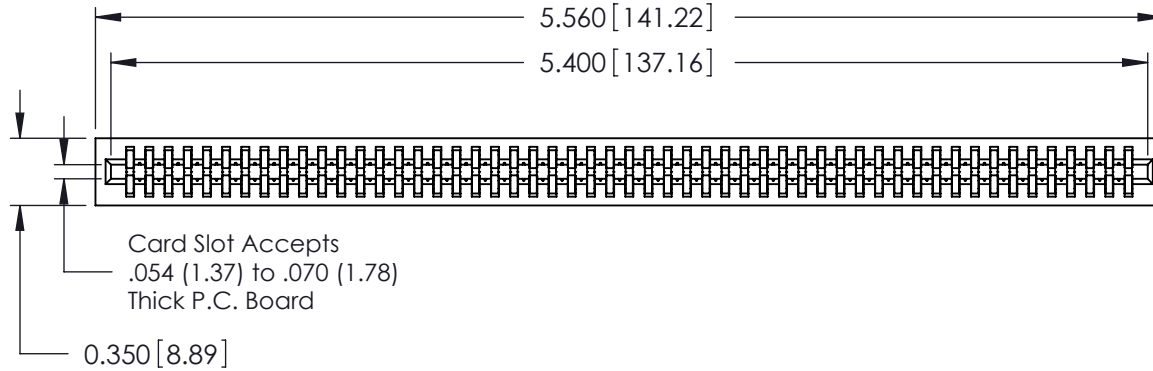

SECTION A-A

725 Series Ultra-Mate Card Edge Connector - Press Fit		ACAD REFERENCE NO.	725-ENG MASTER
Part Number: 725-106-560-201		DRAWN:	J.LEE
		CHECKED:	DATE: AUG31/09
		SCALE:	DATE:
		DRAWING NUMBER	SHEET 1 OF 1
		725-ENG MASTER	ISSUE 1



EDAC INC
 TORONTO, ONTARIO
 CANADA

YOUR CONNECTION TO QUALITY & SERVICE

THESE DRAWINGS AND SPECIFICATIONS
 ARE THE PROPERTY OF EDAC INC. AND
 SHALL NOT BE REPRODUCED, OR COPIED
 OR USED AS THE BASIS FOR THE
 MANUFACTURE OR SALE OF APPARATUS
 WITHOUT WRITTEN PERMISSION.