

FEATURES

Bipolar Voltage Output: AD370

Unipolar Voltage Output: AD371

Low Power: 150mW max

Linearity: $\pm 1/2$ LSB, -55°C to $+125^{\circ}\text{C}$ (S Version)

TTL/CMOS Compatible

Compatible with Standard 18-Pin DAC Configurations

Hermetic 18-Pin DIP ("D" Package)

**Factory Trimmed Gain and Offset: No External Adjustments
Required**

Monotonicity Guaranteed Over Specified Temperature Range

AD370/AD371 FUNCTIONAL BLOCK DIAGRAM

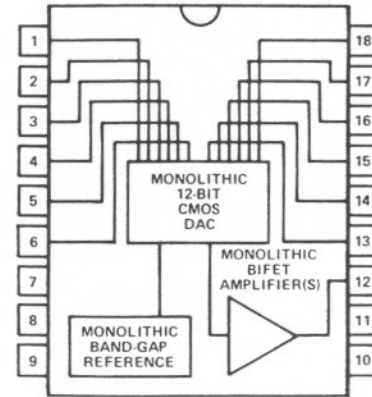

18-PIN DIP

PRODUCT DESCRIPTION

The AD370/AD371 is a complete 12-bit digital-to-analog converter fabricated with the most advanced monolithic and hybrid technologies. The design incorporates a low power monolithic CMOS DAC, precision high speed FET-input operational amplifiers and a low drift reference available in a hermetically sealed package. This innovative design results in significant performance advantages over conventional designs. The integral package-substrate combined with a lower chip count improves reliability over the standard low power hybrids of this type.

The converters come in two versions: AD370 with a bipolar output voltage range (-10V to $+10\text{V}$) and AD371 with a unipolar output voltage range (0 to $+10\text{V}$). Each device is internally laser trimmed for gain and offset to provide adjustment-free operation with only $\pm 0.05\%$ absolute error. The FET input operational amplifiers optimize the speed vs. power trade-off by settling to $1/2$ LSB from a full scale transition in $35\mu\text{s}$ with maximum total power dissipation of only 150mW . The low power monolithic CMOS DAC employs a current-switched silicon-chromium R-2R ladder to ensure that monotonicity is maintained over the full temperature range.

The AD370/AD371 "K" and "S" features $\pm 1/2$ LSB maximum linearity error. Its rated temperature ranges are 0 to $+70^{\circ}\text{C}$ for the "J" and "K" versions and -55°C to $+125^{\circ}\text{C}$ for the "S" version.

PRODUCT HIGHLIGHTS

1. The AD370/AD371 replaces other devices of this type with significant increases in performance.
2. Reduced power consumption requirements (150mW max) result in improved stability and shorter warm-up time.
3. The precision output amplifiers and CMOS DAC have been optimized to settle within $1/2$ LSB for a full scale transition in $35\mu\text{s}$.
4. Reduced chip count and integral package-substrate improve reliability.
5. System performance upgrading is possible without redesign.
6. Internally laser trimmed—no gain or offset adjustments are required for specified accuracy.
7. The device is available in a hermetically-sealed ceramic 18 lead dual-in-line package. Processing to MIL-STD-883 Class B is available.
8. The AD370/AD371 is a second-source for 18-pin 12-bit DACs of the same configuration.

OF APPLICATIONS (typical at $T_A = +25^\circ\text{C}$, $V_S = \pm 15$ Volts unless otherwise noted)

Model	AD370J	AD370K	AD371J	AD371K	AD370S ¹	AD371S ¹	Units
RANGE	-10 to +10	*	0 to +10	**	*	**	Volts
CODE	OCBI	*	CBI	**	*	**	
LINEARITY ERROR							
+25°C	±1	±1/2	±1	±1/2	±1/2	±1/2	LSB ² max
$T_{\min} - T_{\max}$	±1	±1/2	±1	±1/2	±1/2	±1/2	LSB ² max
ABSOLUTE ACCURACY							
+25°C	±0.05	*	*	*	*	*	% of FSR ³ max
$T_{\min} - T_{\max}$	±0.2	*	*	*	±0.3	±0.3	% of FSR ³ max
OFFSET ERROR							
+25°C	±5	*	±1	**	*	**	mV max
FULL SCALE SETTLING TIME							
TO ±1/2LSB	25(35 max)	*	*	*	*	*	μs
INTERNAL REFERENCE	+10.0	*	*	*	*	*	Volts
DIGITAL INPUTS							
V_{INH}	2.0	*	*	*	*	*	Volts min
V_{INL}	0.8	*	*	*	*	*	Volts max
INPUT LEAKAGE CURRENT	±1.0	*	*	*	*	*	μA
INPUT CAPACITANCE	8	*	*	*	*	*	pF
POWER SUPPLY REJECTION RATIO							
+15V Supply	0.01	*	*	*	*	*	% FSR ³ / % V_S max
-15V Supply	0.01	*	*	*	*	*	% FSR ³ / % V_S max
POWER SUPPLY CURRENTS							
+15V Supply	1.5(5 max)	*	*	*	*	*	mA max
-15V Supply	2.5(4 max)	*	*	*	*	*	mA max
POWER DISSIPATION	105(150 max)	*	*	*	*	*	mW
TEMPERATURE RANGE	0 to +70	*	*	*	-55 to +125	***	°C

NOTES

¹ Also available to MIL-STD-883, Level B.

² LSB: Least Significant Bit

³ FSR: Full Scale Range

*Specifications same as AD370J.

**Specifications same as AD371J.

***Specifications same as AD370S.

Specifications subject to change without notice.

ABSOLUTE MAXIMUM RATINGS

($T_A = +25^\circ\text{C}$ unless otherwise noted)

V_{DD} (to GND)	+17V
V_{EE} (to GND)	-17V
Digital Input Voltage Range	V_{DD} to GND
Storage Temperature	-65°C to $+150^\circ\text{C}$

CAUTION – ELECTROSTATIC SENSITIVE DEVICES

The digital control inputs are zener protected; however permanent damage may occur on unconnected units under high energy electrostatic fields. Keep unused units in conductive foam at all times.

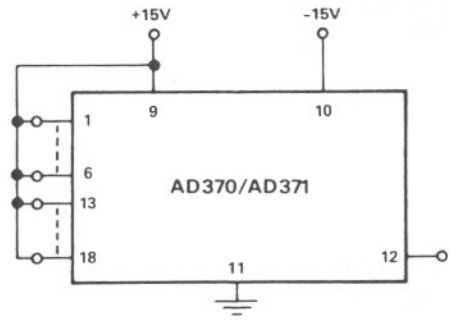

Figure 3. Burn-In Circuit

DIGITAL INPUT	NOMINAL ANALOG OUTPUT
111111111111	0
100000000000	4.9975 Volts
011111111111	5.0000 Volts
000000000000	9.9975 Volts

Table 1. Code Table for the AD371 (CBI)

DIGITAL INPUT	NOMINAL ANALOG OUTPUT
111111111111	-10.000 Volts
100000000000	-0.0097 Volt
100000000000	-0.0048 Volt
011111111111	0
000000000000	9.9952 Volts

Table 2. Code Table for the AD370 (OCBI)

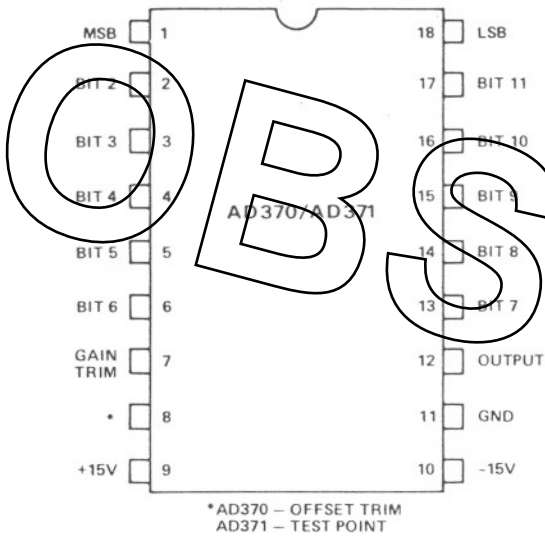

Figure 1. Pin Designations

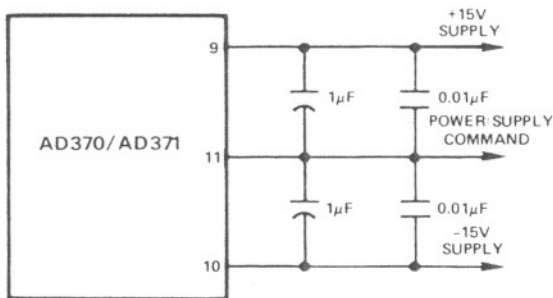

Figure 2. Power Supply Decoupling

Accuracy error of a D/A converter is defined as the difference between the analog output that is expected when a given digital code is applied and the output that is actually measured with that code applied to the converter. Accuracy error can be caused by gain error, zero error or linearity error. The initial accuracy of the AD370/AD371 is trimmed to within 0.05% of full scale by laser trimming the gain and zero errors. Of the error specifications, the linearity error specification is the most important since it cannot be corrected by the user. The linearity error of the AD370/AD371 is specified over its entire temperature range. This means that the analog output will not vary by more than $\pm 1/2$ LSB maximum from an ideal straight line drawn between the end points (inputs all "1s" and all "0s") over the specified operating temperature range of 0 to +70°C for the "K" version and -55°C to +125°C for the "S" version.

The absolute accuracy of the AD370/AD371 has been guaranteed to $\pm 0.05\%$ of full scale by internal factory trim of the gain and offset. External gain and offset adjustment terminals have been made available to allow fine adjustment to the $\pm 0.012\%$ accuracy level. The measurement system used to calibrate the output should be capable of stable resolution of $1/4$ LSB in the regions of zero and full scale. The adjustment procedure, described below, should be carefully followed to assure optimum converter performance.

The proper connections for the offset and gain adjustments are shown in Figure 4. For the AD371 full-scale calibration, apply a digital input of all "1s" and adjust the gain potentiometer to +9.9975 volts (see Table 1).

The offset adjustment of the AD370 is made at the half-scale code. Adjust the offset potentiometer until 0.000V is obtained on the output. The full-scale adjustment is made at the negative endpoint or a code of all "1s". Adjust the gain potentiometer until -10.000 volts is obtained on the output.

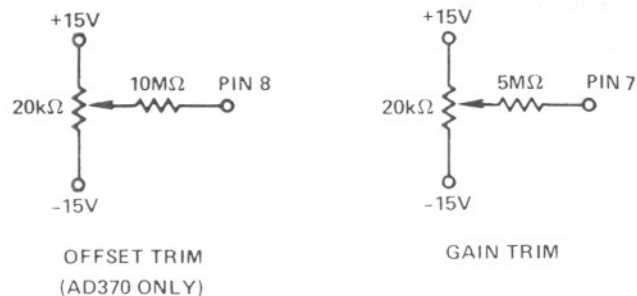

Figure 4. Optional External Trims

SETTLING TIME

Settling time for the AD370/AD371 is the total time required for the output to settle within $\pm 1/2$ LSB band around its final value after a change in input (including slew time). The settling time specification is given for a full scale step which is 20V for the AD370 and 10V for the AD371.

IMPROVED SECOND SOURCE

The substrate design of the AD370/AD371 provides for complete pin-for-pin compatibility with other 18-pin DACs,; Hybrid Systems Corp. DAC340, DAC350 series and Micro Networks Corp. MN360, MN370, MN3200 series 18-pin 12-bit digital-to-analog converters all share the same pin configuration except for pin 7 and pin 8 (see Table 3). The AD370/AD371 is a superior direct replacement for these devices where the function of pins 7 and 8 allow. The versatility designed into the AD370/AD371 allows the function of pin 7 and pin 8 to be configured to exactly second source each of the other units. Information on other second source devices with 4 quadrant multiplying capability is available from Analog Devices.

Analog Devices		Hybrid Systems		Micro Networks		
AD370KD	DAC346C-12BPG			MN360	MN370	MN3711
AD371KD	DAC346C-12UP			MN362	MN371	MN3210
AD370SD	DAC347LPC-12G	DAC356C-12	DAC356LPC-12	MN360H	MN370H	
AD370SD/883B	DAC347LPS-12G	DAC356B-12	DAC356LPB-12			
AD371SD	DAC347LPC-12U			MN362H	MN371H	
AD371SD/883B	DAC347LPB-12U					

Table 3. Cross Reference

AD370/AD371 ORDERING GUIDE

Model	Package	Package Style ¹	Linearity	Output Voltage Range	Operating Temperature Range
AD370JN	Polymer Seal	HY18A	1LSB	-10V to +10V	0 to +70°C
AD370JD	Hermetic	HY18A	1LSB	-10V to +10V	0 to +70°C
AD371JN	Polymer Seal	HY18A	1LSB	0 to +10V	0 to +70°C
AD371JD	Hermetic	HY18A	1LSB	0 to +10V	0 to +70°C
AD370KN	Polymer Seal	HY18A	1/2LSB	-10V to +10V	0 to +70°C
AD370KD	Hermetic	HY18A	1/2LSB	-10V to +10V	0 to +70°C
AD371KN	Polymer Seal	HY18A	1/2LSB	0 to +10V	0 to +70°C
AD371KD	Hermetic	HY18A	1/2LSB	0 to +10V	0 to +70°C
AD370SD	Hermetic	HY18A	1/2LSB	-10V to +10V	-55°C to +125°C
AD370SD/883B	Hermetic	HY18A	1/2LSB	-10V to +10V	-55°C to +125°C
AD371SD	Hermetic	HY18A	1/2LSB	0 to +10V	-55°C to +125°C
AD371SD/883B	Hermetic	HY18A	1/2LSB	0 to +10V	-55°C to +125°C

¹ See Section 20 for package outline information.

18-PIN PACKAGES
(Continued)

HY18A
18-Pin Hybrid Package

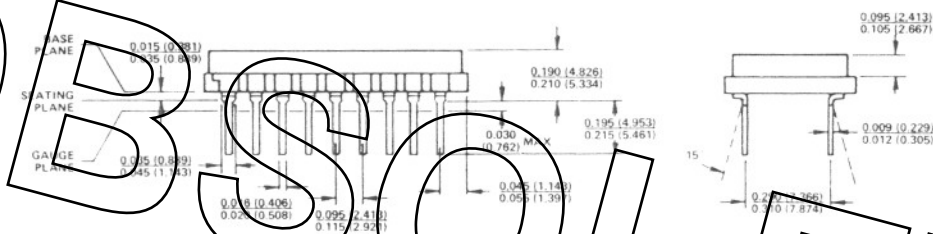
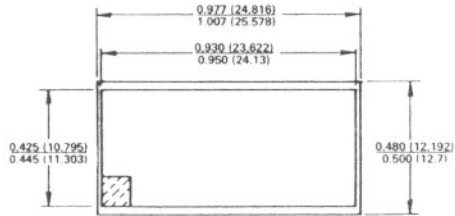

20-PIN PACKAGES

D20A
20-Pin Ceramic DIP Package

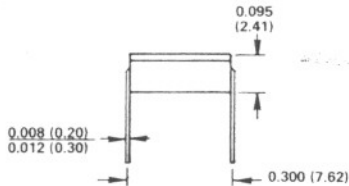
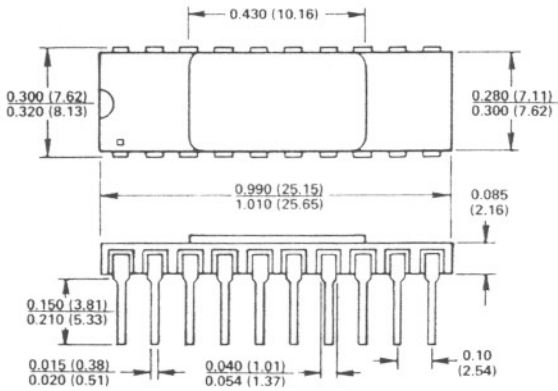

D20B
20-Pin Ceramic DIP Package

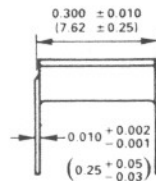
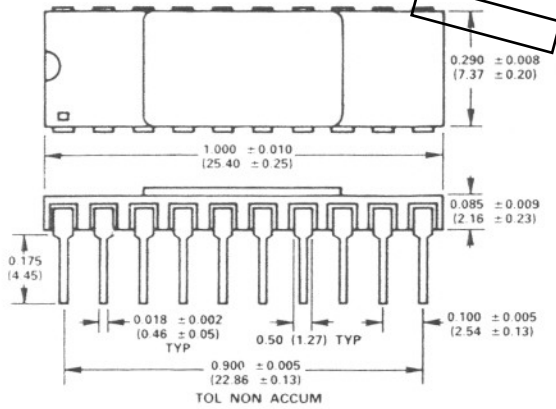

Dimensions shown in inches and (mm).
Lead No. 1 Identified by Dot or Notch.