

micro:bit click adapter

PID:MIKROE-2994 Weight:45 g

Make Learning fun – create embedded toys

We designed the micro:bit adapter to be eye-catching for your kids (or the kid inside you.) With two mikroBUS™ sockets in each hand this awesome gadget will make sure you learn and have fun.

Overview

The BBC **micro:bit** is a credit card sized microcontroller development system, with a very simple and user-friendly visual programming interface, designed to introduce the kids to the world of embedded electronics. The micro:bit project is managed by the micro:bit Educational Foundation. This foundation is a non-profit organization with a very noble goal: giving children around the world a chance to get creative with the technology. You can find more information about the micro:bit project on the official web page.

However, this little development system can be interesting even for more experienced developers, because in its heart, there is a powerful nRF51822 SoC with a 16 MHz ARM Cortex-M0 microcontroller (MCU) with 256 KB Flash and 16 KB RAM, beating. By inserting this ingeniously designed symmetrical development board into the micro:bit Click adapter, the world of possibilities grows exponentially: more than 400 different sensors, displays, drivers, radios, buttons, switches, faders, encoders, relays, converters, and more - neatly packed into the standardized Click board™ form factor, will be just under your fingertips.

Once installed onto the micro:bit Click adapter, the BBC micro:bit can really open the doors to the world of embedded electronics. For those who are more curious, who want to know more: take a peek at the device's datasheet, see which I2C slave address is required, which register turns on that BLUE channel of the RGB driver 3 click and send in the data. Put the I2C, SPI and Serial communication blocks of the micro:bit IDE to a good use!

Note: BBC's micro:bit is not included in the package.

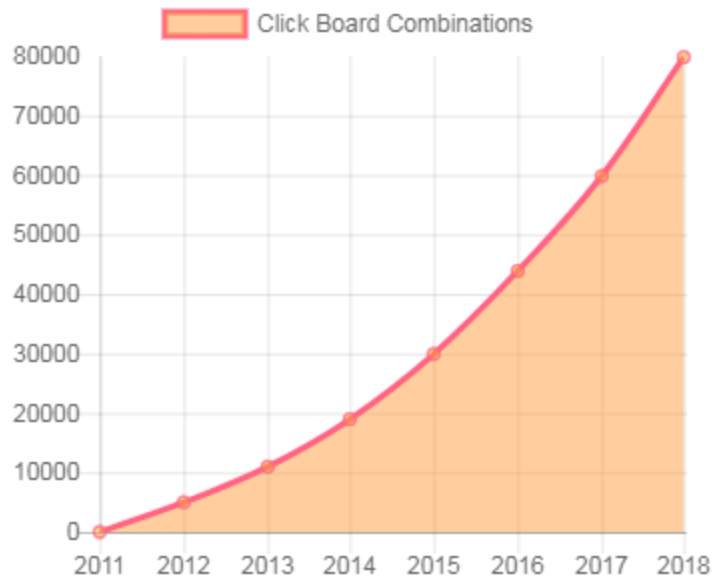

Main features

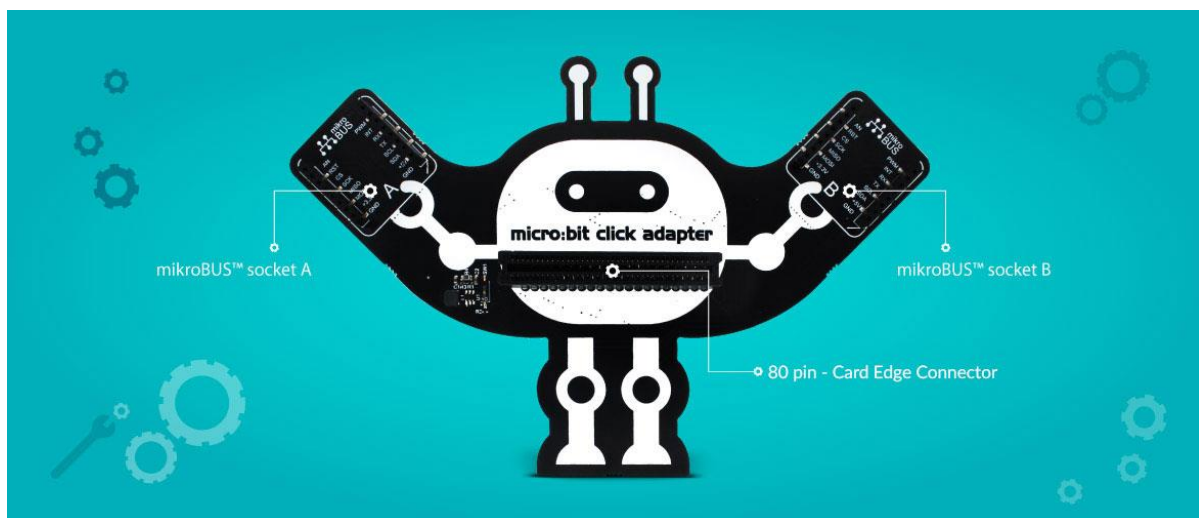

The **micro:bit Click adapter** comes equipped with two proprietary mikroBUS™ sockets, allowing all the Click board™ devices to be interfaced with the micro:bit with no efforts at all. It is enough to place the small standardized add-on board of your choice on the top of the mikroBUS™ socket - and click it in. That is why this small add-on board is called Click board™ - it just clicks!

The mikroBUS™ standard is founded and maintained by MikroElektronika company, allowing all the various Click boards™ to perfectly fit in, without any compatibility issues. Besides the 3.3V available from the micro:bit itself, the micro:bit Click adapter offers an additional 5V power supply (switchable through the onboard switch), required by some of the Click boards™. This allows interfacing with an extended range of different devices. More information about the mikroBUS™ standard can be found on the official mikroBUS™ page.

Power your inventions

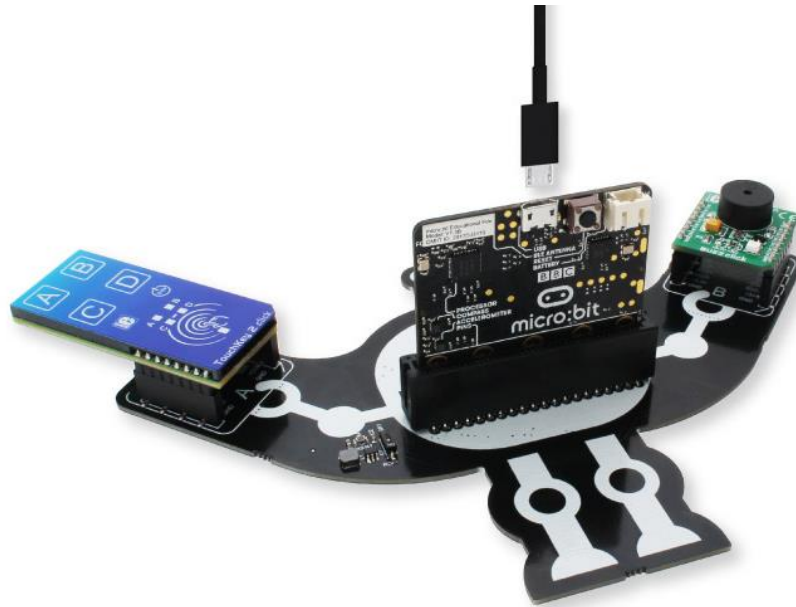

The **micro:bit Click adapter** is powered from the micro:bit itself. An 80pin edge connector allows easy installation to the micro:bit board. Due to the micro:bit symmetrical design, there is no wrong way of connecting. It can be plugged into the connector both ways, keeping it simple.

mikroBUS™ pinout

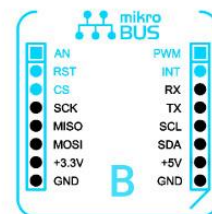
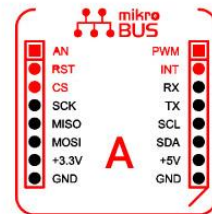
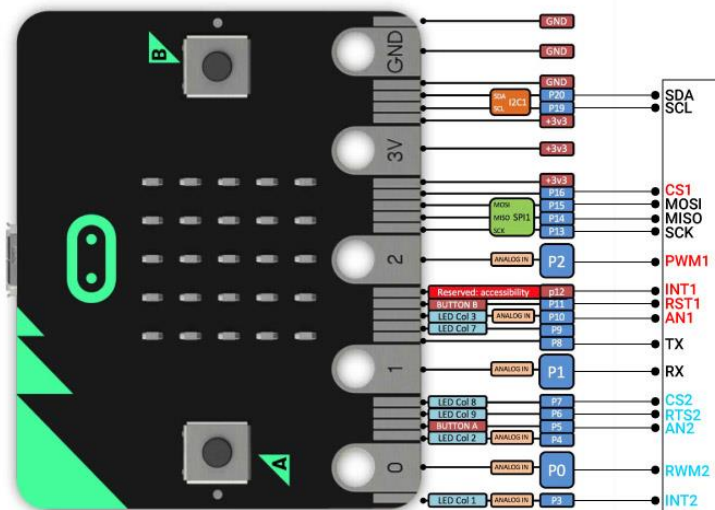

mikroBUS™ A pins ●
mikroBUS™ B pins ●
mutual pins ●

Specification Table

Type	Adapter
Applications	Adding Click board functionalities to the micro:bit
On-board modules	Two mikroBUS™ sockets, 80pin edge connector for the micro:bit board
Interface	PWM,UART,Analog,I2C,SPI
Input Voltage	3.3V,5V

Gallery

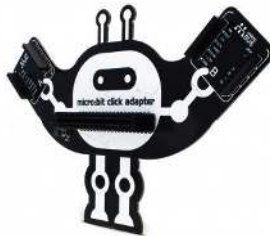
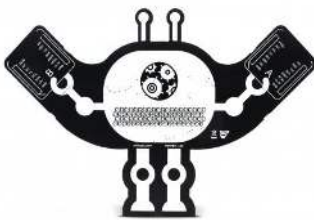
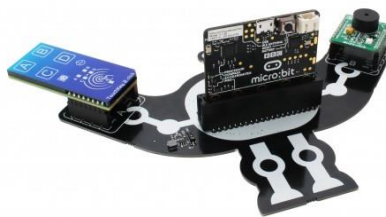

Downloads

[mikroBUS™ Standard specification](#)

[micro:bit click adapter schematic](#)

<https://www.mikroe.com/microbit-click-adapter> 5-11-18