

ALS8W10A – ALS8W43A

Surface Mount Load Dump Transient Voltage Suppressors

REVERSE VOLTAGE – 10~43 Volts
PEAK PULSE POWER – 6600 Watt

FEATURES

- High current capability
- Low Forward Voltage Drop
- Low reverse current
- Low thermal resistance
- Excellent high temperature stability
- Low power loss and high efficiency
- High forward surge capability
- Meet ISO7637-2 and ISO16750-2 surge specification (varied by test condition)
- Meet MSL level 1, per J-STD-020
- LF maximum peak of 260 °C
- AEC-Q101 qualified
- PPAP capable
- Automotive grade
- **Lead-Free Finish; RoHS Compliant (Notes 1 & 2)**
- **Halogen and Antimony Free. "Green" Device (Note 3)**

APPLICATION

- High peak power
- High-temperature
- Clamping diode
- Load switching and lighting
- Use in sensitive electronics protection against voltage transients induced by inductive automotive ECU module, especially for automotive load dump protection application

MECHANICAL DATA

- Case: DO-218 outline plastic package
- Terminals: Matte tin plated, solderable per MIL-STD-750 Method 2026, J-STD-002 and JESD 22-B10^③
- Molding Compound Flammability Rating:UL94-0
- High temperature soldering guaranteed: 260°C/10second
- Polarity: Heatsink is anode
- Corresponds to taping packages. (750PCS/Reel)
- Weight: 2.74 grams (Approximate)

DO-218

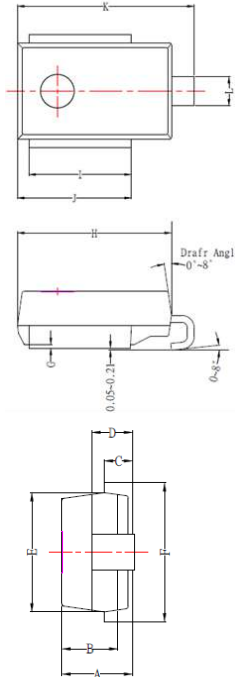

DO-218			
Dim.	Min.	TYP.	Max.
A	4.75	5.00	5.25
B	3.66	3.96	4.26
C	1.80	2.00	2.20
D	2.58	2.88	3.18
E	8.20	8.50	8.80
F	9.50	----	10.50
G	----	0.30	----
H	13.20	13.50	13.80
I	8.70	9.00	9.30
J	9.70	10.00	10.25
K	15.00	15.50	16.00
L	2.30	----	3.00

All Dimensions in millimeter

Primary Characteristics

VWM	10 V to 43 V
VBR	11.1 V to 52.8 V
PPPM (10 x 1000 uS)	6600 W
PPPM (10 x 10 000 uS)	5200 W
IFSM	700 A
Polarity	Uni-directional
Diode variation	Single

Note:

REV-8, Oct-2021, KSIB06

1. EU Directive 2002/95/EC (RoHS), 2011/65/EU (RoHS 2) & 2015/863/EU (RoHS 3) compliant. All applicable RoHS exemptions applied.
2. See <https://www.diodes.com/quality/lead-free/> for more information about Diodes Incorporated's definitions of Halogen- and Antimony-free, "Green" and Lead-free.
3. Halogen- and Antimony-free "Green" products are defined as those which contain <900ppm bromine, <900ppm chlorine (<1500ppm total Br + Cl) and <1000ppm antimony compounds.

Maximum Ratings (TA = 25 °C unless otherwise noted)				
Parameter		Symbol	Value	Units
Peak pulse power dissipation	10/1000 μ s waveform	PPPM	6600	W
	10/10 000 μ s waveform		5200	
Peak forward surge current 8.3 ms single half sine-wave		IFSM	700	A
Operating junction and storage temperature range		TJ, TSTG	-55 to +175	°C

Electrical Characteristics (TA = 25 °C unless otherwise noted)								
Part Number	Breakdown Voltage V _{BR} (V)		Test Current I _T (mA)	Stand-OFF Voltage V _{WM} (V)	Maximum Reverse Leakage at V _{WM} I _D (uA)	Maximum Leakage at V _{WM} T _J = 175 °C I _D (uA)	Max. Peak Pulse Current at 10/1000 us Waveform (A)	Maximum Clamping Voltage at IPPM V _C (V)
	Min.	Max.						
ALS8W10A	11.1	12.3	5.0	10.0	15	250	388	17.0
ALS8W11A	12.2	13.5	5.0	11.0	10	150	363	18.2
ALS8W12A	13.3	14.7	5.0	12.0	10	150	332	19.9
ALS8W13A	14.4	15.9	5.0	13.0	10	150	307	21.5
ALS8W14A	15.6	17.2	5.0	14.0	10	150	284	23.2
ALS8W15A	16.7	18.5	5.0	15.0	10	150	270	24.4
ALS8W16A	17.8	19.7	5.0	16.0	10	150	254	26.0
ALS8W17A	18.9	20.9	5.0	17.0	10	150	239	27.6
ALS8W18A	20.0	22.1	5.0	18.0	10	150	226	29.2
ALS8W20A	22.2	24.5	5.0	20.0	10	150	204	32.4
ALS8W22A	24.4	26.9	5.0	22.0	10	150	186	35.5
ALS8W24A	26.7	29.5	5.0	24.0	10	150	170	38.9
ALS8W26A	28.9	31.9	5.0	26.0	10	150	157	42.1
ALS8W28A	31.1	34.4	5.0	28.0	10	150	145	45.4
ALS8W30A	33.3	36.8	5.0	30.0	10	150	136	48.4
ALS8W33A	36.7	40.6	5.0	33.0	10	150	124	53.3
ALS8W36A	40.0	44.2	5.0	36.0	10	150	114	58.1
ALS8W40A	44.4	49.1	5.0	40.0	10	150	102	64.5
ALS8W43A	47.8	52.8	5.0	43.0	10	150	95.1	69.4

Note:

4. For all types maximum VF = 1.8V at IF = 100A measured on 8.3ms single half sine-wave.

RATING AND CHARACTERISTIC CURVES
ALS8W10A – ALS8W43A

FIG.1- Power Derating Curve

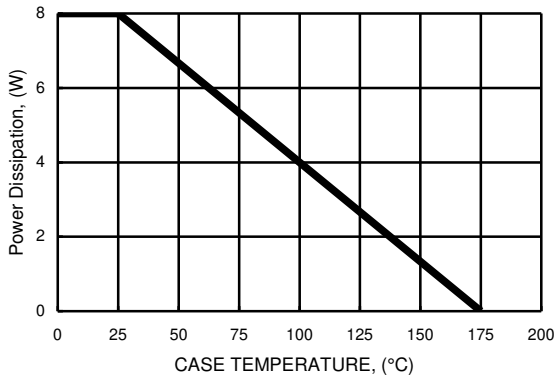

FIG.2- Load Dump Power Characteristics
(10ms Exponential Waveform)

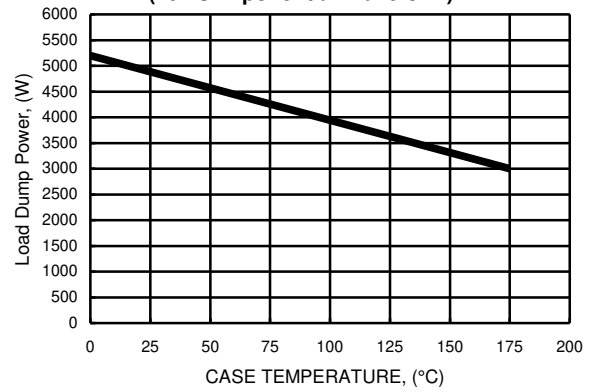

Fig.3 - Pulse Waveform

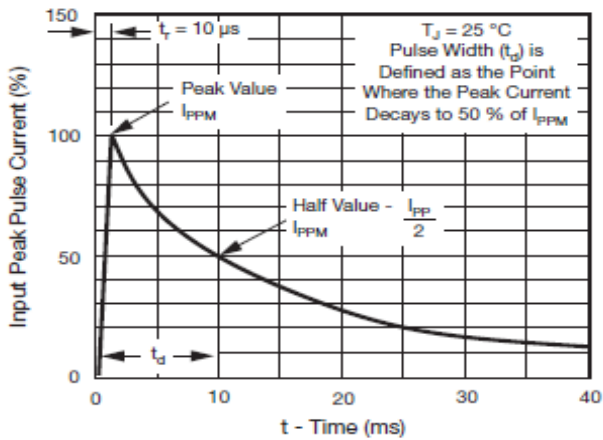

FIG.4- Reverse Power Capability

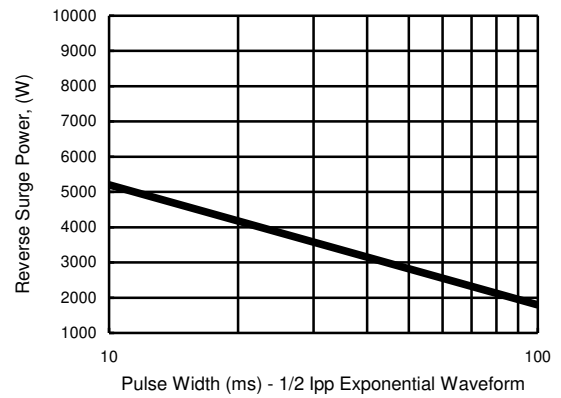

FIG.5- Typical Transient Thermal Impedance

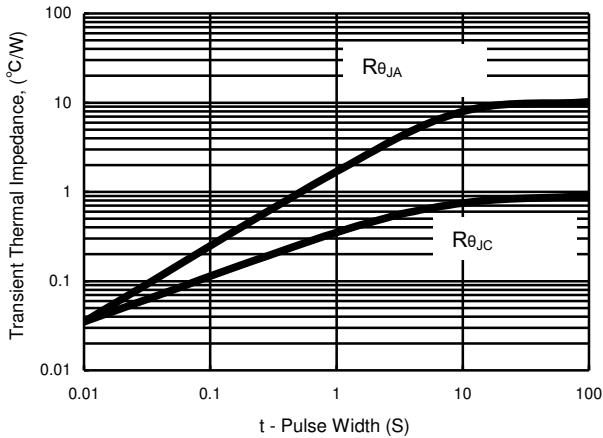
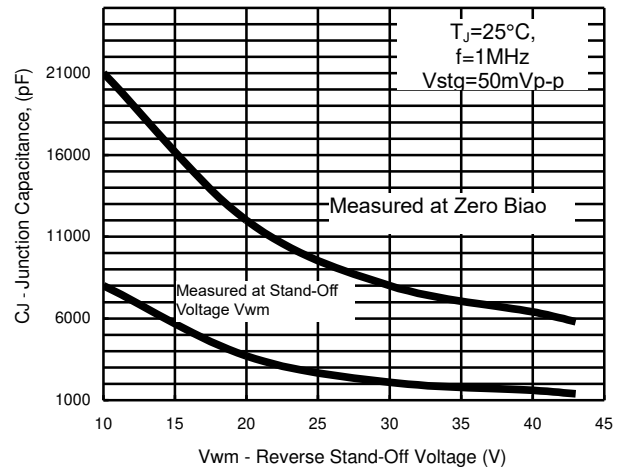
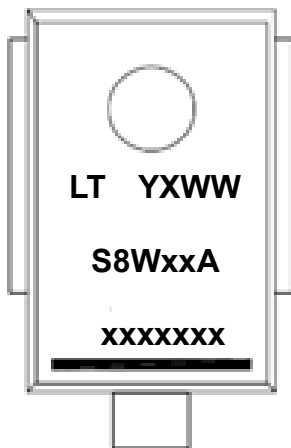

FIG.6- Typical Junction Capacitance



Ordering Information :

Part Number	Case	Packaging
ALS8WxxA	DO-218	750pcs/Reel

Marking Information :

LT = Manufacturer's Code Marking
S8WxxA = Product Type Marking Code
YXWW = Date Code Marking
Y = Last Digit of Year (ex: 1 = 2021)
X = Manufacturer's Internal Code
WW = Week Code (01 to 53)
xxxxxxx = Assembly Tracking Code
Cathode Bar

Packaging Information :

DEVICE	REEL DIA.	Q'TY/REEL	REEL/BOX	Q'TY/BOX	BOX/CARTON	Q'TY/CARTON	BOX SIZE	CARTON SIZE
	(INCH)	(PCS)	(REEL)	(PCS)	(BOX)	(PCS)	(mm)	(mm)
ALS8WxxA	13	750	1	750	4	3000	360*340*52	382*360*240

Soldering Pad Layout :

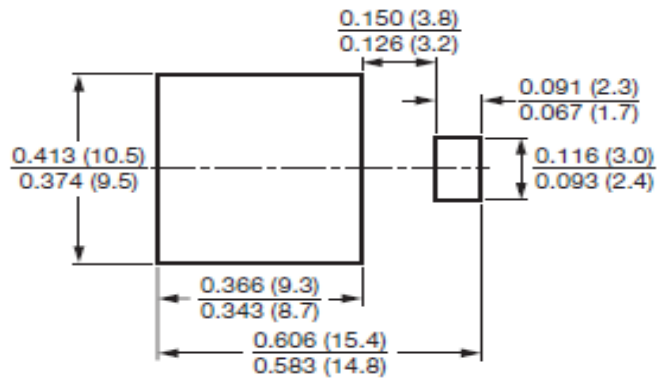

IMPORTANT NOTICE

1. DIODES INCORPORATED AND ITS SUBSIDIARIES ("DIODES") MAKE NO WARRANTY OF ANY KIND, EXPRESS OR IMPLIED, WITH REGARDS TO ANY INFORMATION CONTAINED IN THIS DOCUMENT, INCLUDING, BUT NOT LIMITED TO, THE IMPLIED WARRANTIES OF MERCHANTABILITY, FITNESS FOR A PARTICULAR PURPOSE OR NON-INFRINGEMENT OF THIRD PARTY INTELLECTUAL PROPERTY RIGHTS (AND THEIR EQUIVALENTS UNDER THE LAWS OF ANY JURISDICTION).
2. The Information contained herein is for informational purpose only and is provided only to illustrate the operation of Diodes products described herein and application examples. Diodes does not assume any liability arising out of the application or use of this document or any product described herein. This document is intended for skilled and technically trained engineering customers and users who design with Diodes products. Diodes products may be used to facilitate safety-related applications; however, in all instances customers and users are responsible for (a) selecting the appropriate Diodes products for their applications, (b) evaluating the suitability of the Diodes products for their intended applications, (c) ensuring their applications, which incorporate Diodes products, comply the applicable legal and regulatory requirements as well as safety and functional-safety related standards, and (d) ensuring they design with appropriate safeguards (including testing, validation, quality control techniques, redundancy, malfunction prevention, and appropriate treatment for aging degradation) to minimize the risks associated with their applications.
3. Diodes assumes no liability for any application-related information, support, assistance or feedback that may be provided by Diodes from time to time. Any customer or user of this document or products described herein will assume all risks and liabilities associated with such use, and will hold Diodes and all companies whose products are represented herein or on Diodes' websites, harmless against all damages and liabilities.
4. Products described herein may be covered by one or more United States, international or foreign patents and pending patent applications. Product names and markings noted herein may also be covered by one or more United States, international or foreign trademarks and trademark applications. Diodes does not convey any license under any of its intellectual property rights or the rights of any third parties (including third parties whose products and services may be described in this document or on Diodes' website) under this document.
5. Diodes products are provided subject to Diodes' Standard Terms and Conditions of Sale (<https://www.diodes.com/about/company/terms-and-conditions/terms-and-conditions-of-sales/>) or other applicable terms. This document does not alter or expand the applicable warranties provided by Diodes. Diodes does not warrant or accept any liability whatsoever in respect of any products purchased through unauthorized sales channel.
6. Diodes products and technology may not be used for or incorporated into any products or systems whose manufacture, use or sale is prohibited under any applicable laws and regulations. Should customers or users use Diodes products in contravention of any applicable laws or regulations, or for any unintended or unauthorized application, customers and users will (a) be solely responsible for any damages, losses or penalties arising in connection therewith or as a result thereof, and (b) indemnify and hold Diodes and its representatives and agents harmless against any and all claims, damages, expenses, and attorney fees arising out of, directly or indirectly, any claim relating to any noncompliance with the applicable laws and regulations, as well as any unintended or unauthorized application.
7. While efforts have been made to ensure the information contained in this document is accurate, complete and current, it may contain technical inaccuracies, omissions and typographical errors. Diodes does not warrant that information contained in this document is error-free and Diodes is under no obligation to update or otherwise correct this information. Notwithstanding the foregoing, Diodes reserves the right to make modifications, enhancements, improvements, corrections or other changes without further notice to this document and any product described herein. This document is written in English but may be translated into multiple languages for reference. Only the English version of this document is the final and determinative format released by Diodes.
8. Any unauthorized copying, modification, distribution, transmission, display or other use of this document (or any portion hereof) is prohibited. Diodes assumes no responsibility for any losses incurred by the customers or users or any third parties arising from any such unauthorized use.

Copyright © 2021 Diodes Incorporated

www.diodes.com