



LED Area Light

i9 Series



i9 Series

Beyond LED Technology's i9 Series Area light is the most economical and newest 2021 model. Our i9 Area light offers high lumens per watt for maximum power savings and rebates from power companies. Our i9 Area light is a perfect solution for lighting parking areas, loading docks and other general lighting applications.

- High Efficacy Bridgelux
- Ultra thin sleek design
- Up to 130 lumens per watt
- Several bracket options
- Heat resistant polycarbonate optical lens
- Die Cast Aluminum housing
- Available in White, Bronze or Black Housing
- Universal 100-277Vac / 480Vac optional
- DLC Listed
- 5 Year Warranty

LED Area Light

i9 Series



Specifications



100W/150W/200W



300W

SKU #	Model #	Housing	Watts	Lumens	CCT	IP	Input Voltage	Certifications
151691	BLT-SB03D-100WXYA1-BHbcdef	Black	100W	13200Lm	5000K	IP65	120-277Vac	UL, DLC
151692	BLT-SB03D-100WXYA1-BRbcdef	Bronze	100W	13200Lm	5000K	IP65	120-277Vac	UL, DLC
151696	BLT-SB03D-150WXYA1-BHbcdef	Black	150W	19800Lm	5000K	IP65	120-277Vac	UL, DLC
151697	BLT-SB03D-150WXYA1-BRbcdef	Bronze	150W	19800Lm	5000K	IP65	120-277Vac	UL, DLC
151698	BLT-SB03D-150WXYA1-WHbcdef	White	150W	19800Lm	5000K	IP65	120-277Vac	UL, DLC
151693	BLT-SB03D-200WXYA1-BHbcdef	Black	200W	25000Lm	5000K	IP65	120-277Vac	UL, DLC
151694	BLT-SB03D-200WXYA1-BRbcdef	Bronze	200W	25000Lm	5000K	IP65	120-277Vac	UL, DLC
151699	BLT-SB03D-300WXYA1-BHbcdef	Black	300W	39600Lm	5000K	IP65	120-277Vac	UL, DLC
151700	BLT-SB03D-300WXYA1-BRbcdef	Bronze	300W	39600Lm	5000K	IP65	120-277Vac	UL, DLC
151701	BLT-SB03D-300WXYA1-WHbcdef	White	300W	39600Lm	5000K	IP65	120-277Vac	UL, DLC
151709		Black					Straight Arm Mount	
151710		Bronze					Straight Arm Mount	
151711		White					Straight Arm Mount	
151712		Black					Yoke Mount	
151713		Bronze					Yoke Mount	
151714		White					Yoke Mount	
151706		Black					Slip Fitter Mount	
151707		Bronze					Slip Fitter Mount	
151708		White					Slip Fitter Mount	

LED Area Light

i9 Series



100W Specifications

OPTICAL	Input Power (Tolerance : ±10%)	100W
	Color Temperature	5000K
	Lumen (Tolerance : -10%)	13200LM
	Efficacy (Tolerance : -3%)	132LM/W
	CRI	>70
	Color Consistency	<6 Steps (or <6 SDCM)
	BUG	B3-U5-G3
	Distribution Pattern	Type III (Optional: TYPE IV and TYPE V)
	Beam Angle (50%) (Tolerance : ±15%)	160 Degree
ELECTRICAL	Input Voltage and Frequency	120-277Vac 50/60Hz
	PF (Tolerance : -3%)	≥0.9
	THD (Tolerance : +5%)	≤20%
	Flicker Percent	<5%
	Driver Brand	Daermay
	Driver Model	MP-100TG-130A
	Driver Surge protection	L/N-PE: 6kV, L-N: 6kV
	Dimming	0-10V dimming standard
	Optional Accessory	
MATERIALS	LED Brand	Bridgelux
	LED Type	SMD3030
	LED QTY	120 PCS
	Housing	Die-cast aluminum
	Housing Color	BLACK / BRONZE
	EPA	1.59ft ²
	Waterproof Rating	WET (IP65)
OTHERS	Operating Temperature	Without Motion Sensor: -40°F to 113°F; With Motion Sensor: -31°F to 113°F
	Storage Temperature	-40°F to 176°F
	Operating Humidity	20% - 90% RH
	Storage Humidity	10% - 95% RH
	Warranty	5 years warranty with 24/7 operating hours Luminaire lifetime at 77°F.

CORRELATED COLOR TEMPERATURE (CCT)

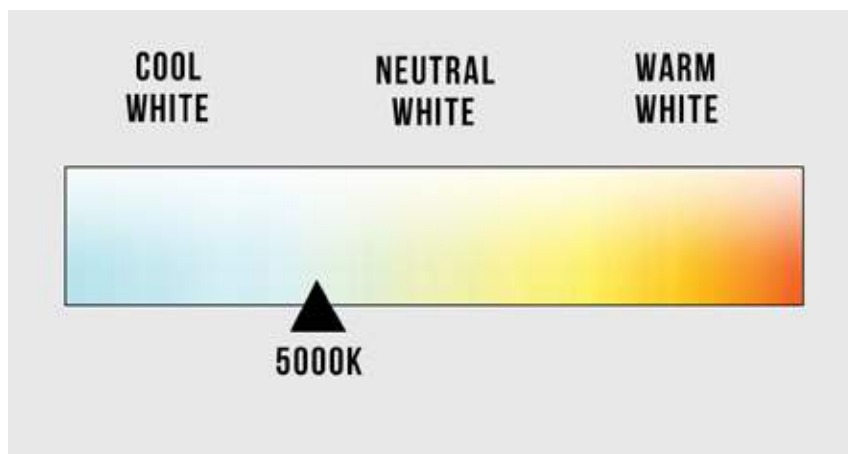

LED Area Light

i9 Series

Distribution Diagram - 100W

Luminous Intensity Distribution Curve

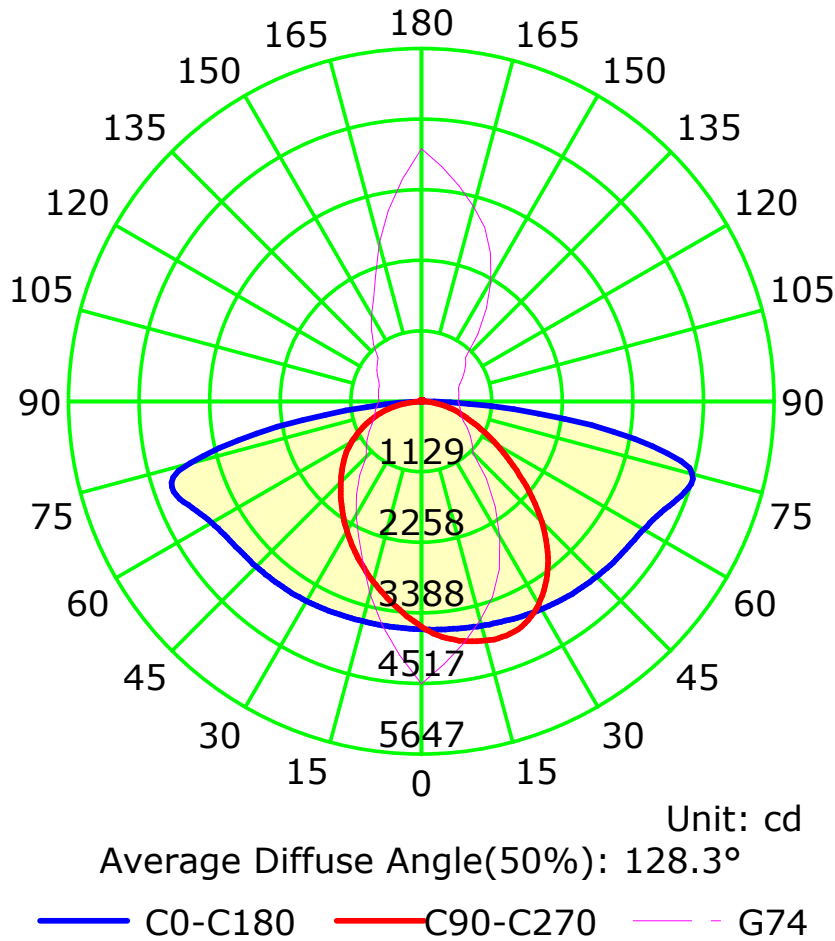

Luminaire Property

Luminaire Manufacturer:

Voltage: 121.5 V

Power: 101.59 W

Current: 0.842 A

Power Factor: 0.993

Photometric Results

IES Classification: Type III

Total Rated Lamp Lumens: 14306.8 lm

Efficiency: 100%

Upward Ratio: 1%

Central Intensity: 3646.42 cd

Pos of Max. Intensity: H0 V74

Longitudinal Classification: Medium

Measurement Flux: 14306.8 lm

Downward Ratio: 99%

Luminaire Efficacy Rating (LER): 140.88

Max. Intensity: 4517.65 cd

LED Area Light

i9 Series



150W Specifications

OPTICAL	Input Power (Tolerance : ±10%)	150W
	Color Temperature	5000K
	Lumen (Tolerance : -10%)	19800LM
	Efficacy (Tolerance : -3%)	132LM/W
	CRI	>70
	Color Consistency	<6 Steps (or <6 SDCM)
	BUG	B4-U5-G4
	Distribution Pattern	Type III (Optional: TYPE IV and TYPE V)
	Beam Angle (50%) (Tolerance : ±15%)	160 Degree
ELECTRICAL	Input Voltage and Frequency	120-277Vac 50/60Hz
	PF (Tolerance : -3%)	≥0.9
	THD (Tolerance : +5%)	≤20%
	Flicker Percent	<5%
	Driver Brand	Daermay
	Driver Model	MP-150TG-130A
	Driver Surge protection	L/N-PE: 6kV, L-N: 6kV
	Dimming	0-10V dimming standard
	Optional Accessory	
MATERIALS	LED Brand	Bridgelux
	LED Type	SMD3030
	LED QTY	170 PCS
	Housing	Die-cast aluminum
	Housing Color	BLACK / BRONZE / WHITE
	EPA	1.59ft ²
	Waterproof Rating	WET (IP65)
OTHERS	Operating Temperature	Without Motion Sensor: -40°F to 113°F; With Motion Sensor: -31°F to 113°F
	Storage Temperature	-40°F to 176°F
	Operating Humidity	20% - 90% RH
	Storage Humidity	10% - 95% RH
	Warranty	5 years warranty with 24/7 operating hours Luminaire lifetime at 77°F.

CORRELATED COLOR TEMPERATURE (CCT)

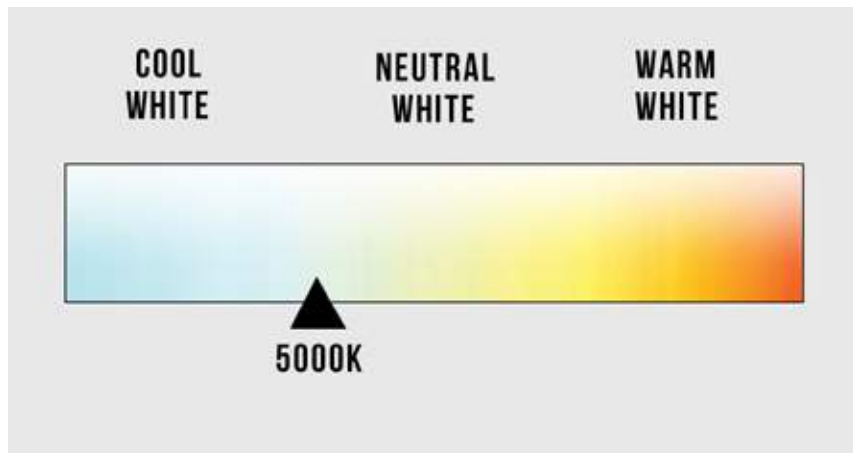

LED Area Light

i9 Series

Distribution Diagram - 150W

Luminous Intensity Distribution Curve

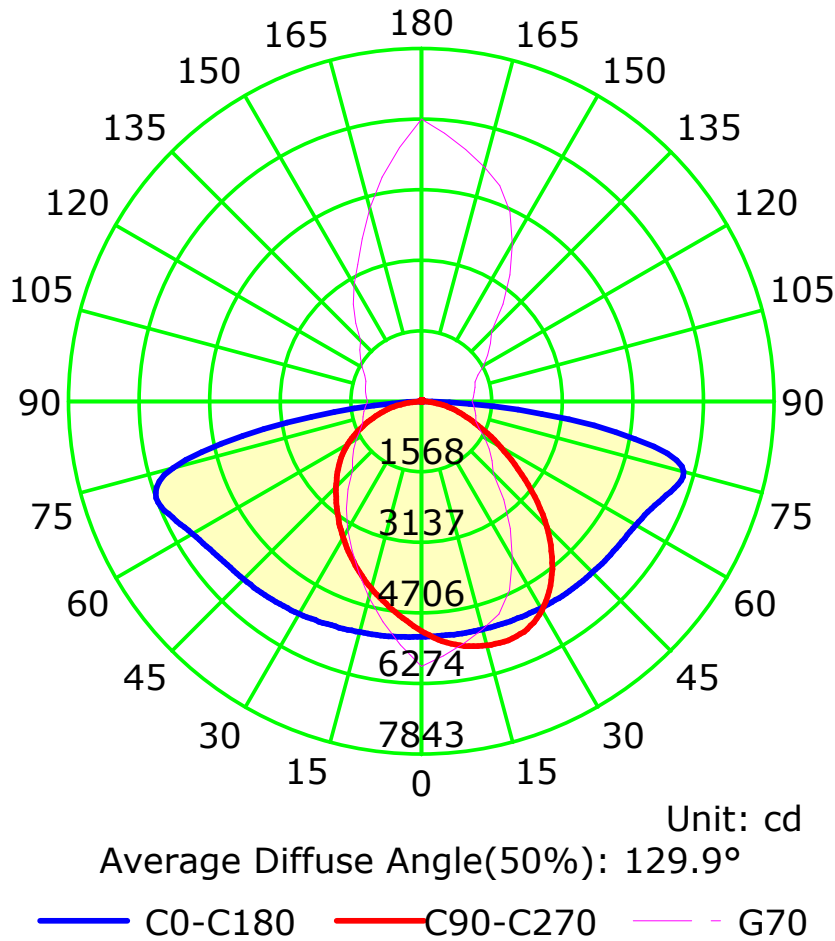

Luminaire Property

Luminaire Manufacturer:

Voltage: 121.5 V

Power: 153.10 W

Current: 1.271 A

Power Factor: 0.991

Photometric Results

IES Classification: Type III

Total Rated Lamp Lumens: 20616.4 lm

Efficiency: 100%

Upward Ratio: 1%

Central Intensity: 5236.32 cd

Pos of Max. Intensity: H180 V70

Longitudinal Classification: Medium

Measurement Flux: 20616.4 lm

Downward Ratio: 99%

Luminaire Efficacy Rating (LER): 134.71

Max. Intensity: 6275 cd

LED Area Light

i9 Series



200W Specifications

OPTICAL	Input Power (Tolerance : ±10%)	200W
	Color Temperature	5000K
	Lumen (Tolerance : -10%)	25000LM
	Efficacy (Tolerance : -3%)	125LM/W
	CRI	>70
	Color Consistency	<6 Steps (or <6 SDCM)
	BUG	B3-U5-G4
	Distribution Pattern	Type III (Optional: TYPE IV and TYPE V)
	Beam Angle (50%) (Tolerance : ±15%)	160 Degree
ELECTRICAL	Input Voltage and Frequency	120-277Vac 50/60Hz
	PF (Tolerance : -3%)	≥0.9
	THD (Tolerance : +5%)	≤20%
	Flicker Percent	<5%
	Driver Brand	Daermay
	Driver Model	MP-200TG-130A
	Driver Surge protection	L/N-PE: 6kV, L-N: 6kV
	Dimming	0-10V dimming standard
	Optional Accessory	
MATERIALS	LED Brand	Bridgelux
	LED Type	SMD3030
	LED QTY	170 PCS
	Housing	Die-cast aluminum
	Housing Color	BLACK / BRONZE
	EPA	1.59ft ²
	Waterproof Rating	WET (IP65)
OTHERS	Operating Temperature	Without Motion Sensor: -40°F to 113°F; With Motion Sensor: -31°F to 113°F
	Storage Temperature	-40°F to 176°F
	Operating Humidity	20% - 90% RH
	Storage Humidity	10% - 95% RH
	Warranty	5 years warranty with 24/7 operating hours Luminaire lifetime at 77°F.

CORRELATED COLOR TEMPERATURE (CCT)

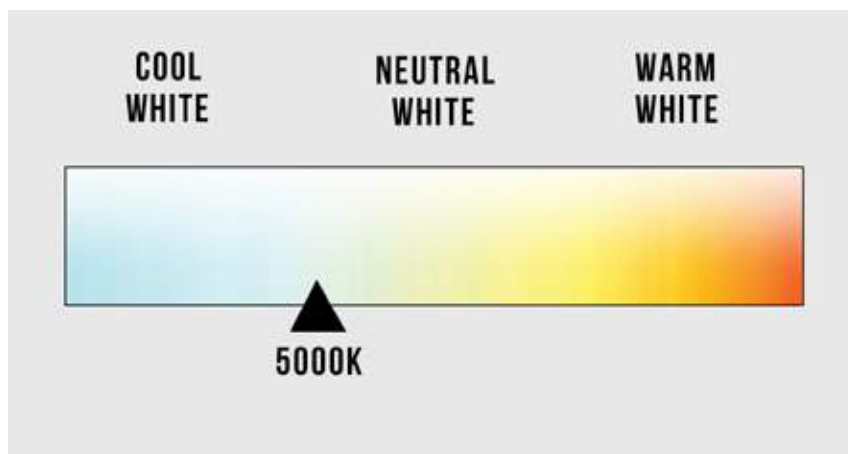

LED Area Light

i9 Series

Distribution Diagram - 200W

Luminous Intensity Distribution Curve

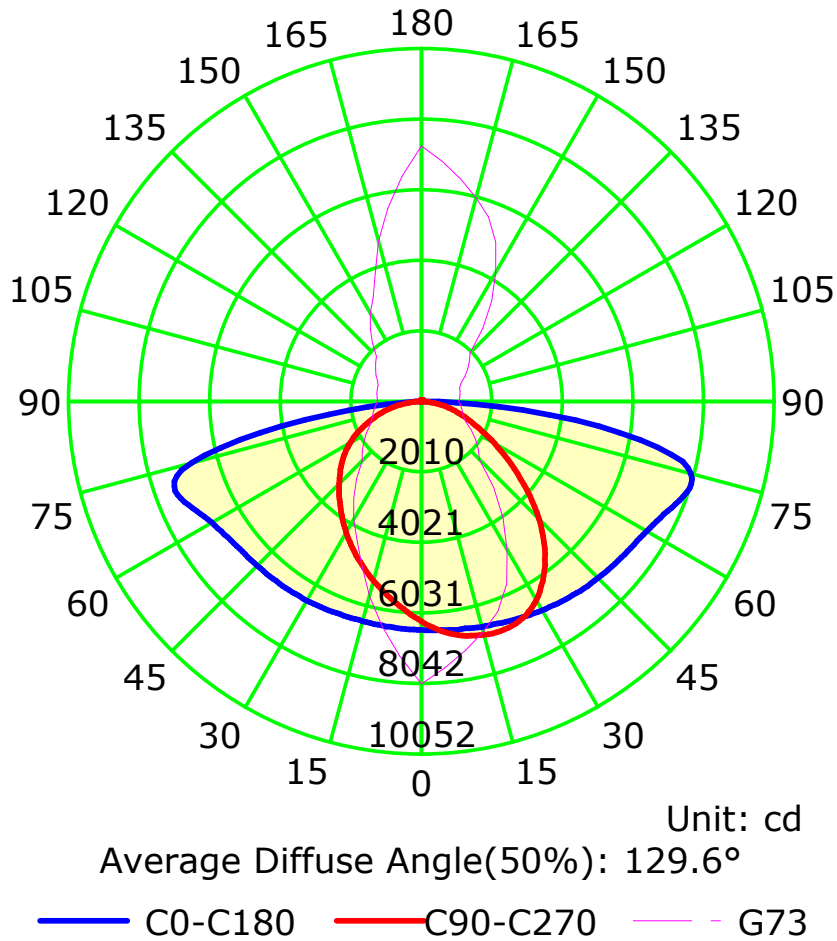

Luminaire Property

Luminaire Manufacturer:

Voltage: 120.9 V

Power: 205.19 W

Current: 1.713 A

Power Factor: 0.991

Photometric Results

IES Classification: Type III

Total Rated Lamp Lumens: 25436.7 lm

Efficiency: 100%

Upward Ratio: 1%

Central Intensity: 6512.4 cd

Pos of Max. Intensity: H0 V73

Longitudinal Classification: Medium

Measurement Flux: 25436.7 lm

Downward Ratio: 99%

Luminaire Efficacy Rating (LER): 124.02

Max. Intensity: 8042.09 cd

LED Area Light

i9 Series



300W Specifications

OPTICAL	Input Power (Tolerance : ±10%)	300W
	Color Temperature	5000K
	Lumen (Tolerance : -10%)	39600LM
	Efficacy (Tolerance : -3%)	132LM/W
	CRI	>70
	Color Consistency	<6 Steps (or <6 SDCM)
	BUG	B5-U5-G5
	Distribution Pattern	Type III (Optional: TYPE IV and TYPE V)
	Beam Angle (50%) (Tolerance : ±15%)	160 Degree
	ELECTRICAL	Input Voltage and Frequency
PF (Tolerance : -3%)		≥0.9
THD (Tolerance : +5%)		≤20%
Flicker Percent		<5%
Driver Brand		Daermay
Driver Model		MP-150TG-130A *2
Driver Surge protection		L/N-PE: 6kV, L-N: 6kV
Dimming		0-10V dimming standard
Optional Accessory		
MATERIALS	LED Brand	Bridgelux
	LED Type	SMD3030
	LED QTY	340 PCS
	Housing	Die-cast aluminum
	Housing Color	BLACK / BRONZE / WHITE
	EPA	3.48ft ²
	Waterproof Rating	WET (IP65)
OTHERS	Operating Temperature	Without Motion Sensor: -40°F to 113°F; With Motion Sensor: -31°F to 113°F
	Storage Temperature	-40°F to 176°F
	Operating Humidity	20% - 90% RH
	Storage Humidity	10% - 95% RH
	Warranty	5 years warranty with 24/7 operating hours Luminaire lifetime at 77°F.

CORRELATED COLOR TEMPERATURE (CCT)

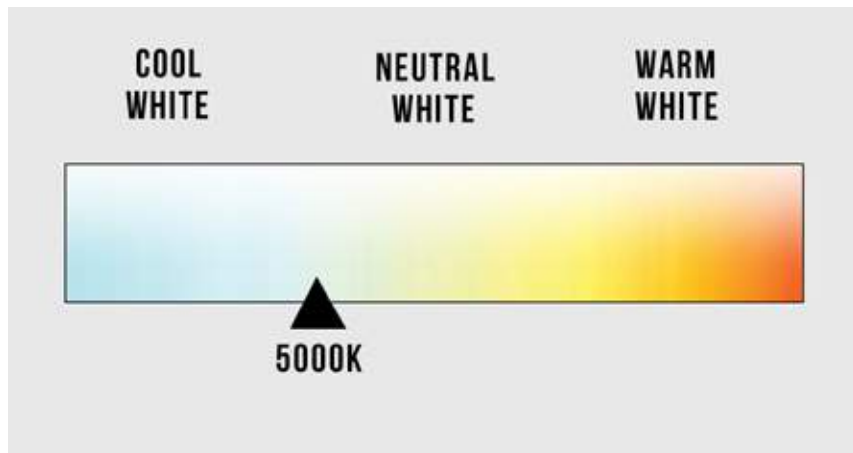

LED Area Light

i9 Series

Distribution Diagram - 300W

Luminous Intensity Distribution Curve

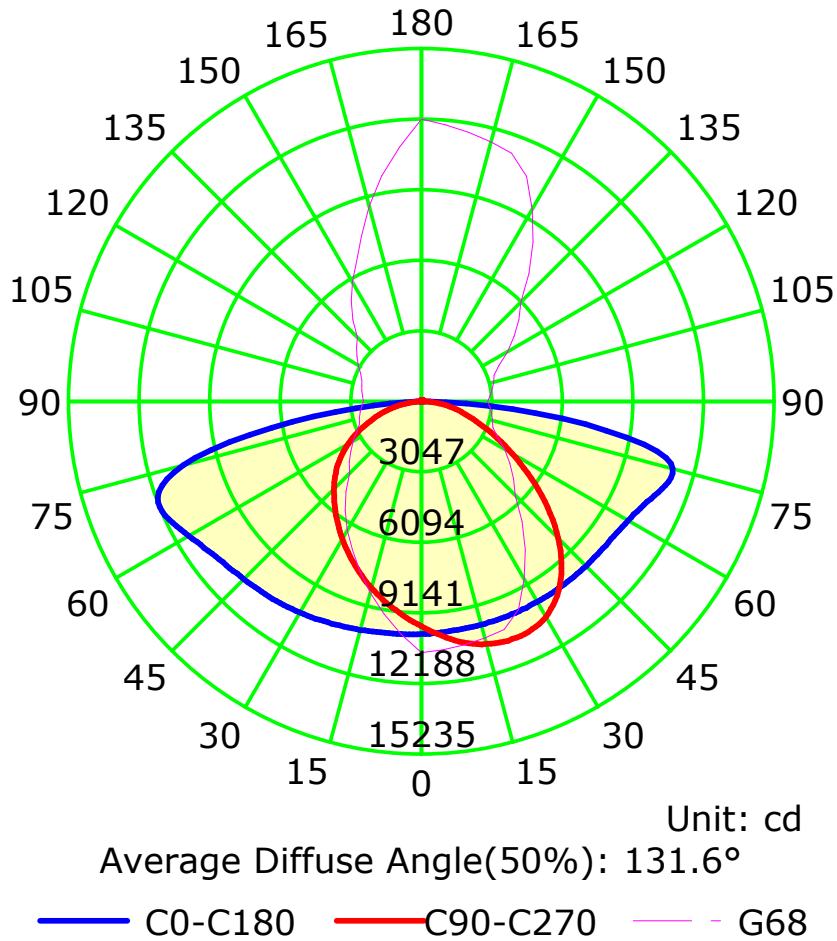

Luminaire Property

Luminaire Manufacturer:

Voltage: 118.9 V

Power: 306.50 W

Current: 2.597 A

Power Factor: 0.992

Photometric Results

IES Classification: Type IV

Total Rated Lamp Lumens: 41046.3 lm

Efficiency: 100%

Upward Ratio: 1%

Central Intensity: 10050.64 cd

Pos of Max. Intensity: H180 V68

Longitudinal Classification: Medium

Measurement Flux: 41046.3 lm

Downward Ratio: 99%

Luminaire Efficacy Rating (LER): 133.97

Max. Intensity: 12188.45 cd

LED Area Light

i9 Series

Dimensions

100W/150W/200W

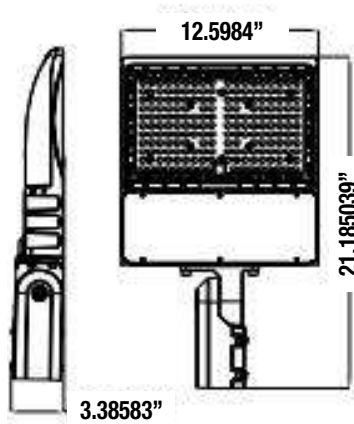

Slip Fitter Mount

300W

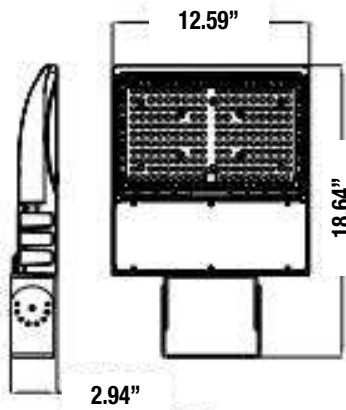
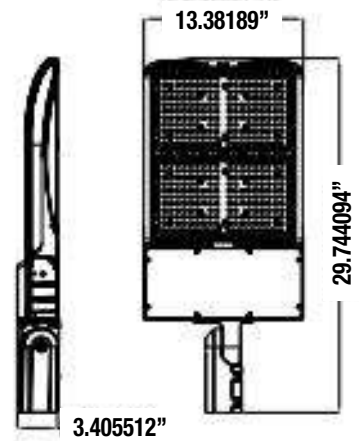

Yoke Mount

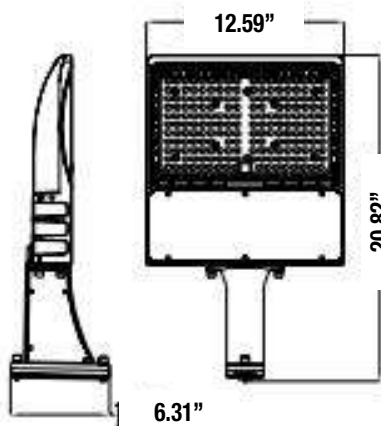
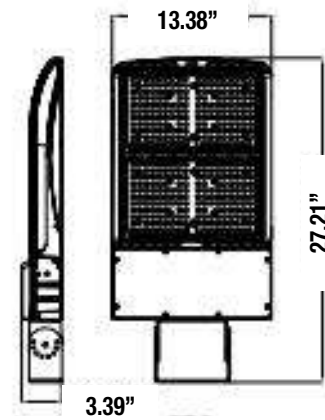

Straight Arm Mount

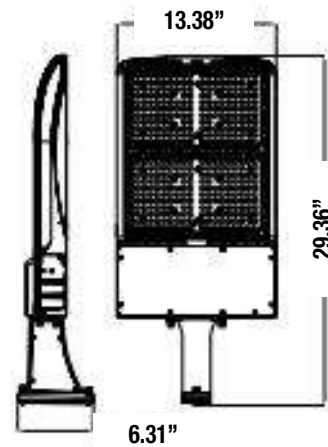

LED Area Light

i9 Series

Packaging

Tolerance of Carton Size: ± 0.590551 in, Tolerance of Weight: $\pm 10\%$.

Model	Pcs/Box	Dimensions	Weight	Pallet Quantity	Pallet Weight	Pallet Dimensions
100W	1	23" X 15" X 7"	12 Lb			
150W	1	23" X 15" X 7"	12 Lb			
200W	1	23" X 15" X 7"	12 Lb			
300W	1	33" X 16" X 7"	20 Lb			
Slip Fitter Mount	1	10" X 5" X 5"	6 Lb			
Straight Arm Mount	1	10" X 5" X 5"	6 Lb			
Yoke Mount	1	10" X 5" X 5"	4 Lb			



LED Area Light

i9 Series

User Notice

- Please turn off the power before installing or changing assembly parts.
- The input voltage and lamps should be matching. Before connecting the power line, please make sure the wiring section is insulated.
- Only professionals should install and disassemble the lamps.

Trouble Shooting

- Flickering light - Turn off the power and turn on again in 3 minutes. If the same phenomena occurs, then call Support.
- Not working - Please check all power connections.

