

SERIES: PRMC3-S | **DESCRIPTION:** DC-DC CONVERTER**FEATURES**

- 3 W isolated output
- smaller package
- single/dual regulated outputs
- 3,000 Vdc isolation
- continuous short circuit protection
- temperature range (-40~105°C)
- efficiency up to 84%
- EN/BS EN 62368-1 certified



| MODEL | input voltage | | output voltage (Vdc) | output current | | output power max (W) | ripple and noise ¹ max (mVp-p) | efficiency typ (%) |
|------------------------------|---------------|----------------|-------------------------|----------------|-------------|----------------------------|---|--------------------------|
| | typ (Vdc) | range (Vdc) | | min (mA) | max (mA) | | | |
| PRMC3-D5-S5-S ² | 5 | 4.5~9 | 5 | 25 | 500 | 2.5 | 100 | 73 |
| PRMC3-D5-S9-S ² | 5 | 4.5~9 | 9 | 14 | 278 | 2.5 | 100 | 74 |
| PRMC3-D5-S12-S ² | 5 | 4.5~9 | 12 | 10 | 208 | 2.5 | 100 | 77 |
| PRMC3-D5-S15-S ² | 5 | 4.5~9 | 15 | 8 | 167 | 2.5 | 100 | 74 |
| PRMC3-D5-D5-S ² | 5 | 4.5~9 | ±5 | ±13 | ±250 | 2.5 | 100 | 74 |
| PRMC3-D5-D12-S ² | 5 | 4.5~9 | ±12 | ±5 | ±104 | 2.5 | 100 | 77 |
| PRMC3-D5-D15-S ² | 5 | 4.5~9 | ±15 | ±4 | ±83 | 2.5 | 100 | 77 |
| PRMC3-D12-S3-S ² | 12 | 9~18 | 3.3 | 38 | 758 | 2.5 | 100 | 74 |
| PRMC3-D12-S5-S ² | 12 | 9~18 | 5 | 30 | 600 | 3 | 100 | 76 |
| PRMC3-D12-S12-S ² | 12 | 9~18 | 12 | 13 | 250 | 3 | 100 | 82 |
| PRMC3-D12-S15-S ² | 12 | 9~18 | 15 | 10 | 200 | 3 | 100 | 83 |
| PRMC3-D12-D5-S ² | 12 | 9~18 | ±5 | ±15 | ±300 | 3 | 100 | 78 |
| PRMC3-D12-D12-S ² | 12 | 9~18 | ±12 | ±6 | ±125 | 3 | 100 | 79 |
| PRMC3-D12-D15-S ² | 12 | 9~18 | ±15 | ±5 | ±100 | 3 | 100 | 80 |
| PRMC3-D24-S3-S ² | 24 | 18~36 | 3.3 | 38 | 758 | 2.5 | 100 | 74 |
| PRMC3-D24-S5-S ² | 24 | 18~36 | 5 | 30 | 600 | 3 | 100 | 81 |
| PRMC3-D24-S9-S ² | 24 | 18~36 | 9 | 17 | 333 | 3 | 100 | 83 |
| PRMC3-D24-S12-S ² | 24 | 18~36 | 12 | 13 | 250 | 3 | 100 | 83 |
| PRMC3-D24-S15-S ² | 24 | 18~36 | 15 | 10 | 200 | 3 | 100 | 83 |
| PRMC3-D24-S24-S ² | 24 | 18~36 | 24 | 6 | 125 | 3 | 100 | 83 |
| PRMC3-D24-D5-S ² | 24 | 18~36 | ±5 | ±15 | ±300 | 3 | 100 | 79 |
| PRMC3-D24-D12-S ² | 24 | 18~36 | ±12 | ±6 | ±125 | 3 | 100 | 83 |
| PRMC3-D24-D15-S ² | 24 | 18~36 | ±15 | ±5 | ±100 | 3 | 100 | 83 |
| PRMC3-D48-S5-S | 48 | 36~75 | 5 | 30 | 600 | 3 | 100 | 76 |
| PRMC3-D48-S12-S | 48 | 36~75 | 12 | 13 | 250 | 3 | 100 | 80 |
| PRMC3-D48-S15-S | 48 | 36~75 | 15 | 10 | 200 | 3 | 100 | 84 |

**MODEL
(CONTINUED)**

| MODEL (CONTINUED) | input voltage | | output voltage | output current | | output power | ripple and noise ¹ | efficiency |
|----------------------|---------------|-------------|----------------|----------------|----------|--------------|-------------------------------|------------|
| | typ (Vdc) | range (Vdc) | (Vdc) | min (mA) | max (mA) | max (W) | typ (mVp-p) | typ (%) |
| PRMC3-D48-D5-S | 48 | 36~75 | ±5 | ±15 | ±300 | 3 | 100 | 79 |
| PRMC3-D48-D12-S | 48 | 36~75 | ±12 | ±6 | ±125 | 3 | 100 | 82 |
| PRMC3-D48-D15-S | 48 | 36~75 | ±15 | ±5 | ±100 | 3 | 100 | 82 |

Notes: 1. Ripple and noise are measured at 20 MHz BW by "parallel cable" method with 1 µF ceramic and 10 µF electrolytic capacitors on the output.
2. Model is not CE certified.

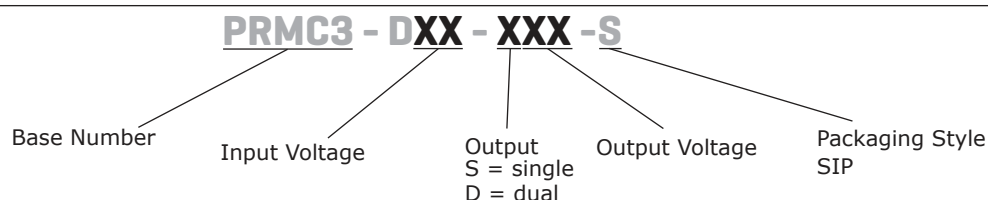
PART NUMBER KEY**INPUT**

| parameter | conditions/description | min | typ | max | units |
|-------------------------|---|------|-----|-----|-------|
| operating input voltage | 5 Vdc input models | 4.5 | 5 | 9 | Vdc |
| | 12 Vdc input models | 9 | 12 | 18 | Vdc |
| | 24 Vdc input models | 18 | 24 | 36 | Vdc |
| | 48 Vdc input models | 36 | 48 | 75 | Vdc |
| start-up voltage | 5 Vdc input models | 3.5 | 4 | 4.5 | Vdc |
| | 12 Vdc input models | 4.5 | 8 | 9 | Vdc |
| | 24 Vdc input models | 11 | 16 | 18 | Vdc |
| | 48 Vdc input models | 24 | 33 | 36 | Vdc |
| surge voltage | for maximum of 1 second | | | | |
| | 5 Vdc input models | -0.7 | | 12 | Vdc |
| | 12 Vdc input models | -0.7 | | 25 | Vdc |
| | 24 Vdc input models | -0.7 | | 50 | Vdc |
| filter | capacitance filter | | | | |
| CTRL ³ | models ON (CTRL open or insulated) | | | | |
| | models OFF (connect voltage, current into CTRL is 5~10mA) | | | | |

Notes: 3. See application notes on page 6.

OUTPUT

| parameter | conditions/description | min | typ | max | units |
|---------------------------------------|--|-----|-------|-------|-------|
| line regulation | full load, input voltage from low to high | | ±0.2 | ±0.5 | % |
| load regulation | 5% to 100% load | | ±0.2 | ±0.5 | % |
| voltage accuracy | 5% to 100% load | | ±1 | ±3 | % |
| no-load voltage accuracy ⁴ | input voltage range | | ±1.5 | ±5 | % |
| voltage balance ⁵ | dual output, balanced loads | | ±0.5 | ±1 | % |
| switching frequency | 100% load, nominal input voltage, PFM mode | | 250 | | KHz |
| transient recovery time | 25% load step change | | 0.5 | 3 | ms |
| transient response deviation | 25% load step change | | ±2.5 | ±5 | % |
| temperature coefficient | 100% load | | ±0.02 | ±0.03 | %/°C |

Notes: 4. The max no-load voltage accuracy for PRMC3-D12-S3-S is ±8%
5. For dual output models, unbalanced loads should not exceed ±5%. If ±5% is exceeded, it may not meet all specifications.

PROTECTIONS

| parameter | conditions/description | min | typ | max | units |
|--------------------------|--------------------------------|-----|-----|-----|-------|
| short circuit protection | continuous, automatic recovery | | | | |

SAFETY AND COMPLIANCE

| parameter | conditions/description | min | typ | max | units |
|------------------------------|---|-----------|-----|-----|-------|
| isolation voltage | input to output for 1 minute at 1 mA max. | 3,000 | | | Vdc |
| isolation resistance | input to output at 500 Vdc | 1,000 | | | MΩ |
| safety approvals | certified to 62368-1: EN, BS EN | | | | |
| conducted emissions | CISPR22/EN55022, class B (external circuit required, see Figure 1-b) | | | | |
| radiated emissions | CISPR22/EN55022, class B (external circuit required, see Figure 1-b) | | | | |
| ESD | IEC/EN61000-4-2, class B, contact ± 4kV | | | | |
| radiated immunity | IEC/EN61000-4-3, class A, 10V/m | | | | |
| EFT/burst | IEC/EN61000-4-4, class B, ± 2kV (external circuit required, see Figure 1-a) | | | | |
| surge | IEC/EN61000-4-5, class B, ± 2kV (external circuit required, see Figure 1-a) | | | | |
| conducted immunity | IEC/EN61000-4-6, class A, 3 Vr.m.s | | | | |
| voltage dips & interruptions | IEC/EN61000-4-29, class B, 0%-70% | | | | |
| MTBF | as per MIL-HDBK-217F @ 25°C | 1,000,000 | | | hours |
| RoHS | 2011/65/EU | | | | |

ENVIRONMENTAL

| parameter | conditions/description | min | typ | max | units |
|-----------------------|------------------------|-----|-----|-----|-------|
| operating temperature | see derating curve | -40 | | 105 | °C |
| storage temperature | | -55 | | 125 | °C |
| storage humidity | non-condensing | | | 95 | % |
| temperature rise | at full load, Ta=25°C | | 25 | | °C |

SOLDERABILITY

| parameter | conditions/description | min | typ | max | units |
|----------------|---------------------------------|-----|-----|-----|-------|
| hand soldering | 1.5 mm from case for 10 seconds | | | 300 | °C |
| wave soldering | see wave soldering profile | | | 260 | °C |

MECHANICAL

| parameter | conditions/description | min | typ | max | units |
|---------------|---|-----|-----|-----|-------|
| dimensions | 22.00 x 9.50 x 12.00 (0.866 x 0.374 x 0.472 inch) | | | | mm |
| case material | plastic (UL94-V0) | | | | |
| weight | | | 4.9 | | g |

MECHANICAL DRAWING

units: mm[inch]
 tolerance: ±0.25[±0.010]
 pin section tolerance: ±0.10[±0.004]

| PIN CONNECTIONS | | |
|-----------------|---------------|-------------|
| PIN | Single Output | Dual Output |
| 1 | GND | GND |
| 2 | Vin | Vin |
| 3 | CTRL | CTRL |
| 5 | NC | NC |
| 6 | +Vo | +Vo |
| 7 | 0V | 0V |
| 8 | CS | -Vo |

NC: No Connection

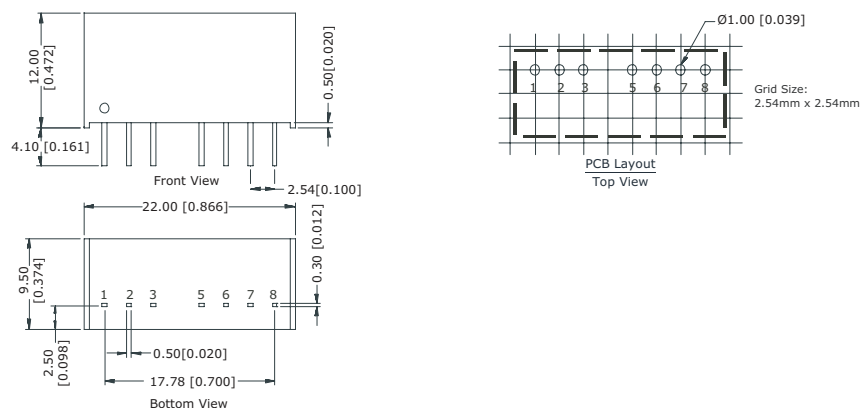

DERATING CURVES

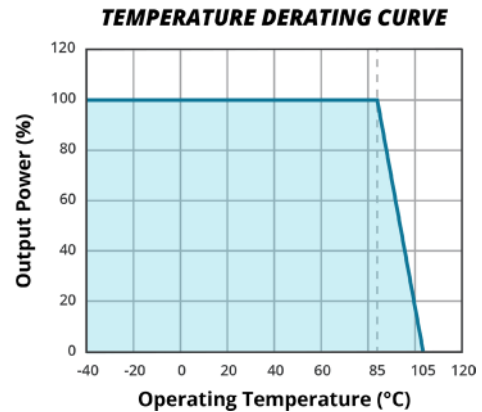
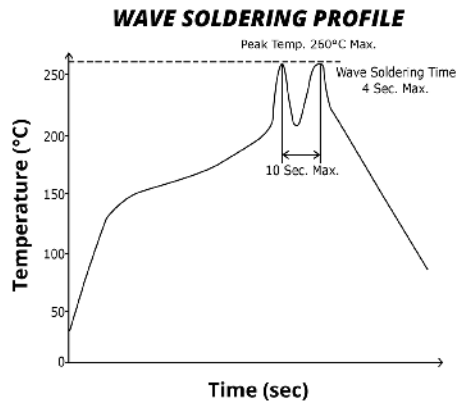

EMC RECOMMENDED CIRCUIT

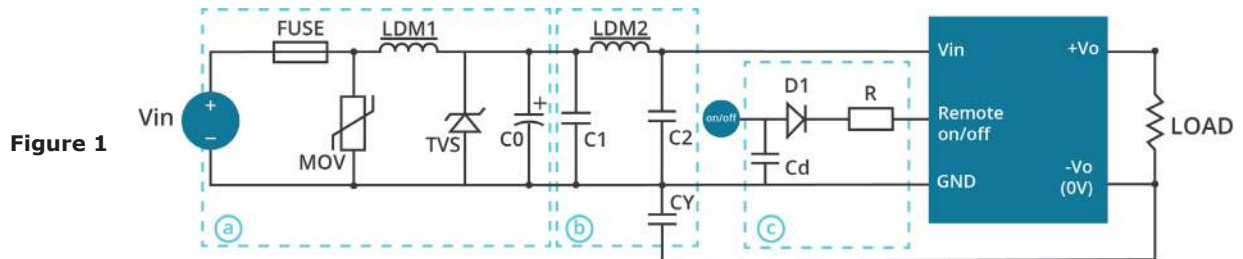

Figure 1

| Recommended external circuit components | | | | |
|---|--|--------------|--------------|--------------|
| Vin (Vdc) | 5 | 12 | 24 | 48 |
| FUSE | choose according to practical input current | | | |
| MOV | -- | -- | 10D560 | 10D101 |
| LDM1 | -- | -- | 56μH | 56μH |
| TVS | SMCJ13A | SMCJ28A | SMCJ48A | SMCJ90A |
| C0 | 680μF/16V | 680μF/25V | 120μF/50V | 120μF/100V |
| C1 | 4.7μF/50V | 4.7μF/50V | 4.7μF/50V | 4.7μF/100V |
| LDM2 | 12μH | 12μH | 12μH | 12μH |
| C2 | 4.7μF/50V | 4.7μF/50V | 4.7μF/50V | 4.7μF/100V |
| CY | 1nF/3kV | 1nF/3kV | 1nF/3kV | 1nF/3kV |
| D1 | RB160M-60/1A | RB160M-60/1A | RB160M-60/1A | RB160M-60/1A |
| R | Follows: $R = \frac{V_C - V_D - 1.0}{I_C} - 300$ | | | |
| Cd | 47nF/100V | 47nF/100V | 47nF/100V | 47nF/100V |

Table 1

Note: Figure 1-c is on/off control circuit. See page 6 for details.

TEST CONFIGURATION

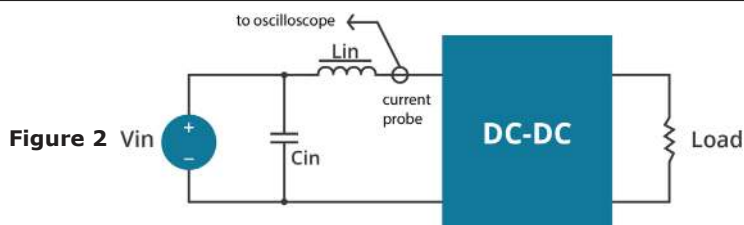

Figure 2

Table 2

| External components | |
|---------------------|------------------------------|
| Lin | 4.7μH |
| Cin | 220μF, ESR < 1.0Ω at 100 KHz |

Note: Input reflected-ripple current is measured with an inductor Lin and Capacitor Cin to simulate source impedance.

APPLICATION NOTES

1. Output load requirement

To ensure this module can operate efficiently and reliably, the minimum output load may not be less than 5% of the full load during operation. If the actual output power is low, connect a resistor at the output end in parallel to increase the load.

2. Recommended circuit

This series has been tested according to the following recommended testing circuit before leaving the factory. This series should be tested under load (see Figure 3 and Table 3). If you want to further decrease the input/output ripple, you can increase the capacitance accordingly or choose capacitors with low ESR. However, the capacitance of the output filter capacitor must be appropriate. If the capacitance is too high, a startup problem might arise. For every channel of the output, to ensure safe and reliable operation, the maximum capacitance must be less than the maximum capacitive load (see Table 4).



Figure 3

Table 3

| Vin (Vdc) | Cin1 (µF) | Cin2 (µF) | Lin (µH) | Cs ¹ (µF) | Cout (µF) | Lout ² (µH) | Cd (nF/V) |
|-----------|-----------|-----------|----------|----------------------|-----------|------------------------|-----------|
| 5 | 100 | 47 | 4.7~12 | 10~22 | 100 | 2.2~10 | 47/100 |
| 12 | 100 | 47 | 4.7~12 | 10~22 | 100 | 2.2~10 | 47/100 |
| 24 | 10 | 1 | 4.7~12 | 10~22 | 100 | 2.2~10 | 47/100 |
| 48 | 10 | 1 | 4.7~12 | 10~22 | 100 | 2.2~10 | 47/100 |

Note: 1. For single output only
2. For dual output only

Table 4

| Single Vout (Vdc) | Max. Capacitive Load (µF) | Dual Vout (Vdc) | Max. Capacitive Load ¹ (µF) |
|-------------------|---------------------------|-----------------|--|
| 3.3 | 2700 | -- | -- |
| 5 | 2200 | 5 | 1000 |
| 9 | 1000 | -- | -- |
| 12 | 680 | 12 | 470 |
| 15 | 470 | 15 | 330 |
| 24 | 330 | -- | -- |

Note: 1. For each output.

3. CTRL Terminal

When open or applied high impedance, the converter will turn on. When it's pulled high, the converter will shutdown. The input current should be between 5~10mA. Exceeding the maximum 20mA will cause permanent damage to the converter. The value for R can be derived as follows:

$$R = \frac{V_c - V_D - 1.0}{I_c} - 300$$

V_c: Control pin input voltage
V_D: Forward voltage drop of diode D1
I_c: Input current to control pin
R: Resistor of control circuit

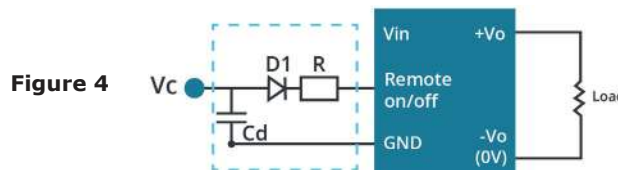

Figure 4

4. Input Current

When it is used in an unregulated condition, make sure that the input fluctuations and ripple voltage do not exceed the module standard. Refer to Figure 5 and Table 5 for the startup current of this dc-dc module.

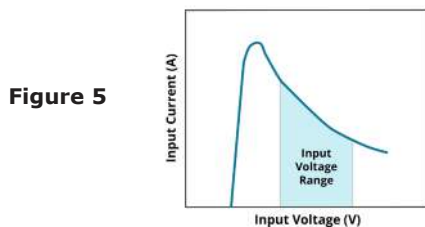

Figure 5

Table 5

| Vin (Vdc) | I _p (mA) |
|-----------|---------------------|
| 5 | 1110 |
| 12 | 640 |
| 24 | 325 |
| 48 | 160 |

Note: 1. Minimum load shouldn't be less than 5%, otherwise ripple may increase dramatically. Operation under minimum load will not damage the converter, however, they may not meet all specifications listed.
2. Maximum capacitive load is tested at input voltage range and full load.
3. All specifications are measured at Ta=25°C, humidity<75%, nominal input voltage and rated output load unless otherwise specified.

REVISION HISTORY

| rev. | description | date |
|------|--|------------|
| 1.0 | initial release | 05/05/2014 |
| 1.01 | safeties updated in features and safety approvals line | 01/19/2021 |
| 1.02 | derating curve and circuit figures updated | 11/15/2021 |
| 1.03 | CE certification updated for 5, 12, 24V models | 12/06/2022 |

The revision history provided is for informational purposes only and is believed to be accurate.



CUI INC

a bel group

Headquarters
20050 SW 112th Ave.
Tualatin, OR 97062
800.275.4899

Fax 503.612.2383
cui.com
techsupport@cui.com

CUI offers a two (2) year limited warranty. Complete warranty information is listed on our website.

CUI reserves the right to make changes to the product at any time without notice. Information provided by CUI is believed to be accurate and reliable. However, no responsibility is assumed by CUI for its use, nor for any infringements of patents or other rights of third parties which may result from its use.

CUI products are not authorized or warranted for use as critical components in equipment that requires an extremely high level of reliability. A critical component is any component of a life support device or system whose failure to perform can be reasonably expected to cause the failure of the life support device or system, or to affect its safety or effectiveness.