

FP 0,8/ 32-MV-SH 7,15 - SMD male connector, shielded

1154007

<https://www.phoenixcontact.com/us/products/1154007>

Please be informed that the data shown in this PDF document is generated from our online catalog. Please find the complete data in the user documentation. Our general terms of use for downloads are valid.



shielded SMD male connector, nominal current: 1.7 A, Test voltage: 500 V AC, number of positions: 32, pitch: 0.8 mm, color: black, contact surface: Gold, contact connection type: Pin, mounting: SMD soldering

Your advantages

- Gold-plated contacts ensure transfer quality remains stable over the long term
- Reliable mechanical and electrical connections, thanks to the double-sided ScaleX contact system
- Robustness: ScaleX technology for high tolerance compensation and protection of contacts
- Flexible device design: various numbers of positions, designs, and stack heights with high wipe lengths

Commercial data

Item number	1154007
Packing unit	1 pc
Minimum order quantity	300 pc
Sales key	AA23
Product key	AAWJDD
GTIN	4063151153779
Weight per piece (including packing)	3.93 g
Weight per piece (excluding packing)	2.22 g
Customs tariff number	85366930
Country of origin	CN

FP 0,8/ 32-MV-SH 7,15 - SMD male connector, shielded



1154007

<https://www.phoenixcontact.com/us/products/1154007>

Technical data

Product properties

Product type	shielded SMD male connector
Product family	FP 0,8/...-MV-SH 7,15
Number of positions	32
Pitch	0.8 mm
Number of rows	2
Pin layout	Linear pad geometry

Electrical properties

Nominal current I_N	1.7 A IEC 60512-5-2:2002-02 (at 20°C 80-pos.)
Degree of pollution	3
Contact resistance	25 mΩ
Test voltage	500 V AC IEC 60512-4-1:2003

Mounting

Mounting type	SMD soldering
Pin layout	Linear pad geometry

Processing notes

Moisture Sensitive Level	MSL 1
--------------------------	-------

Material specifications

Material data - contact

Note	WEEE/RoHS-compliant, free of whiskers according to IEC 60068-2-82/JEDEC JESD 201
Contact material	Cu alloy
Surface characteristics	Selective coating
Metal surface contact area (top layer)	Gold (Au)
Metal surface contact area (middle layer)	Nickel (Ni)
Metal surface soldering area (top layer)	Tin (Sn)
Metal surface soldering area (middle layer)	Nickel (Ni)

Material data - housing

Color (Housing)	black (9005)
Insulating material	LCP
Insulating material group	IIIb
CTI according to IEC 60112	150
Flammability rating according to UL 94	V0

Notes

FP 0,8/ 32-MV-SH 7,15 - SMD male connector, shielded



1154007

<https://www.phoenixcontact.com/us/products/1154007>

Notes on operation	The permissible voltage during operation depends on the application, taking into consideration the air clearances and creepage distances within the scope of insulation requirements in accordance with IEC 60664-1.
Details for soldering processes	The items are suitable for assembly on both sides and for overhead soldering.

Dimensions

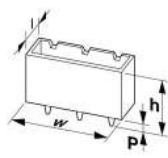
Dimensional drawing	
Pitch	0.8 mm
Width [w]	16.7 mm
Height [h]	12.25 mm
Length [l]	6.1 mm
Installed height	11.65 mm

Application

Contact cover	0.8 mm
Center offset	± 0.7 mm in longitudinal and transverse direction
Stack height	12 mm Tolerance: +1,5 mm (in combination with Range of articles:FP 0,8/...-FV-SH 4,85)
	15 mm Tolerance: +1,5 mm (in combination with Range of articles:FP 0,8/...-FV-SH 7,85)
	18 mm Tolerance: +1,5 mm (in combination with Range of articles:FP 0,8/...-FV-SH 10,85)
Wipe length	1.5 mm
Angular tolerance	± 5 ° in longitudinal and transverse direction (when plugging in)
	± 5 ° in longitudinal and transverse direction (when plugged in)
Axial offset in X direction (longitudinal)	± 0.3 mm (Tolerance compensation when plugged in)
Axial offset in Y direction (transversal)	± 0.3 mm (Tolerance compensation when plugged in)

PCB design

Pad geometry	0.5 x 1.1 mm
--------------	--------------

Electrical tests

Thermal test | Test group C

Specification	IEC 60512-5-2:2002-02
Tested number of positions	80

Insulation resistance

Specification	IEC 60512-3-1:2002-02
Insulation resistance, neighboring positions	≥ 5 GΩ

Air clearances and creepage distances |

FP 0,8/ 32-MV-SH 7,15 - SMD male connector, shielded

1154007

<https://www.phoenixcontact.com/us/products/1154007>

Insulating material group	IIIb
Minimum value for clearance and creepage distance	0.25 mm

Environmental and real-life conditions

Vibration test

Specification	IEC 60068-2-6:2007-12
Frequency	10 - 2000 - 10 Hz
Sweep speed	1 octave/min
Amplitude	1.5 mm (10 Hz ... 58 Hz)
Sweep speed	200 m/s ² (58 Hz ... 2000 Hz)
Test duration per axis	2.5 h

Durability test

Specification	IEC 60512-9-1:2010-03 (following)
Contact resistance R ₁	25 mΩ
Contact resistance R ₂	25 mΩ
Insertion/withdrawal cycles	500
Insulation resistance, neighboring positions	≥ 5 GΩ

Shocks

Specification	IEC 60068-2-27:2008-02
Pulse shape	Semi-sinusoidal
Acceleration	490 m/s ²
Shock duration	11 ms
Test directions	X-, Y- and Z-axis (pos. and neg.)

Ambient conditions

Ambient temperature (operation)	-55 °C ... 125 °C
Ambient temperature (storage/transport)	-40 °C ... 70 °C
Relative humidity (storage/transport)	30 % ... 70 %
Ambient temperature (assembly)	-5 °C ... 100 °C

Packaging specifications

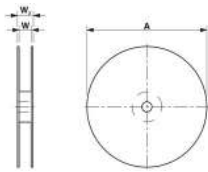
Dimensional drawing	
Type of packaging	44 mm wide tape
[W] tape width	44 mm
[W2] coil overall dimension	330 mm
[A] coil diameter	50.4 mm
Outer packaging type	Transparent-Bag
ESD level	(D) electrostatically conductive

FP 0,8/ 32-MV-SH 7,15 - SMD male connector, shielded



1154007

<https://www.phoenixcontact.com/us/products/1154007>

Specification

DIN EN 61340-5-1 (VDE 0300-5-1): 2008-07

FP 0,8/ 32-MV-SH 7,15 - SMD male connector, shielded



1154007

<https://www.phoenixcontact.com/us/products/1154007>

Drawings

Diagram

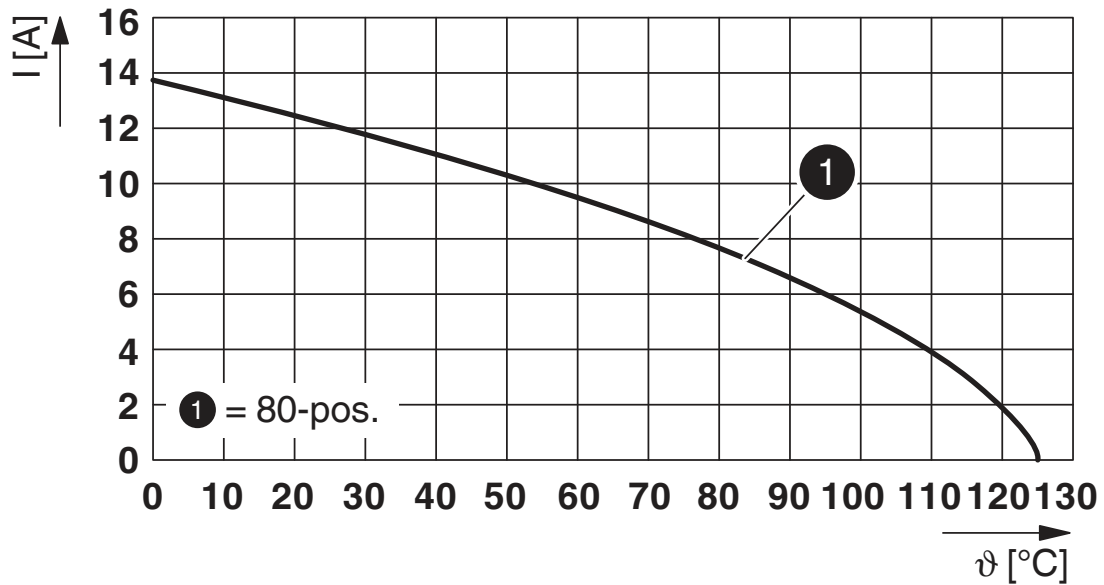

Type: FP 0,8/...-MV-SH 7,15 with FP 0,8/...-FV-SH 4,85 - shroud

Diagram

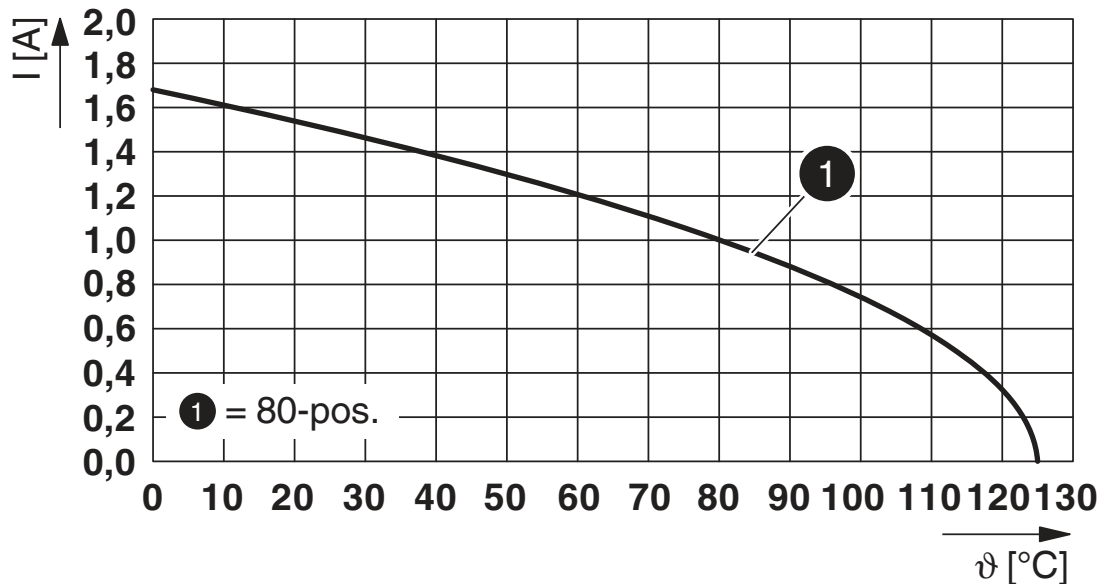

Type: FP 0,8/...-MV-SH 7,15 with FP 0,8/...-FV-SH 4,85 - contacts

FP 0,8/ 32-MV-SH 7,15 - SMD male connector, shielded



1154007

<https://www.phoenixcontact.com/us/products/1154007>

Approvals

To download certificates, visit the product detail page: <https://www.phoenixcontact.com/us/products/1154007>



cULus Recognized

Approval ID: E118976-20190703

FP 0,8/ 32-MV-SH 7,15 - SMD male connector, shielded



1154007

<https://www.phoenixcontact.com/us/products/1154007>

Classifications

ECLASS

ECLASS-11.0	27460201
ECLASS-12.0	27460201
ECLASS-13.0	27460201

ETIM

ETIM 8.0	EC002637
----------	----------

UNSPSC

UNSPSC 21.0	39121400
-------------	----------

FP 0,8/ 32-MV-SH 7,15 - SMD male connector, shielded



1154007

<https://www.phoenixcontact.com/us/products/1154007>

Environmental product compliance

China RoHS	Environmentally friendly use period: unlimited = EFUP-e
	No hazardous substances above threshold values

FP 0,8/ 32-MV-SH 7,15 - SMD male connector, shielded

1154007

<https://www.phoenixcontact.com/us/products/1154007>

Mandatory accessories

FP 0,8/ 32-FH-SH - SMD female connector shielded

1043723

<https://www.phoenixcontact.com/us/products/1043723>



Shielded SMD female connector, nominal current: 1.7 A, Test voltage: 500 V AC, number of positions: 32, pitch: 0.8 mm, color: black, contact surface: Gold, contact connection type: Socket, mounting: SMD soldering

FP 0,8/ 32-FV-SH 10,85 - SMD female connectors

1154033

<https://www.phoenixcontact.com/us/products/1154033>



Shielded SMD female connector, nominal current: 1.7 A, Test voltage: 500 V AC, number of positions: 32, pitch: 0.8 mm, color: black, contact surface: Gold, contact connection type: Socket, mounting: SMD soldering

FP 0,8/ 32-MV-SH 7,15 - SMD male connector, shielded

1154007

<https://www.phoenixcontact.com/us/products/1154007>

FP 0,8/ 32-FV-SH 4,85 - SMD female connector shielded

1043711

<https://www.phoenixcontact.com/us/products/1043711>



Shielded SMD female connector, nominal current: 1.7 A, Test voltage: 500 V AC, number of positions: 32, pitch: 0.8 mm, color: black, contact surface: Gold, contact connection type: Socket, mounting: SMD soldering

FP 0,8/ 32-FV-SH 7,85 - SMD female connector shielded

1043683

<https://www.phoenixcontact.com/us/products/1043683>



Shielded SMD female connector, nominal current: 1.7 A, Test voltage: 500 V AC, number of positions: 32, pitch: 0.8 mm, color: black, contact surface: Gold, contact connection type: Socket, mounting: SMD soldering

Accessories

FP 0,8/ 32-MV-SH 7,15 - SMD male connector, shielded



1154007

<https://www.phoenixcontact.com/us/products/1154007>

FP 0,8/ 32-FV-SH 4,85 - SMD female connector shielded

1043711

<https://www.phoenixcontact.com/us/products/1043711>



Shielded SMD female connector, nominal current: 1.7 A, Test voltage: 500 V AC, number of positions: 32, pitch: 0.8 mm, color: black, contact surface: Gold, contact connection type: Socket, mounting: SMD soldering

Phoenix Contact 2023 © - all rights reserved

<https://www.phoenixcontact.com>

Phoenix Contact USA
586 Fulling Mill Road
Middletown, PA 17057, United States
(+717) 944-1300
info@phoenixcon.com