



Features

Package	2 wattage class LED (at 700mA drive) with large size LED die, High efficiency and High luminous flux Outer dimension: 3.5 x 3.5 x 2.1mm (L x W x H)
Product features	<ul style="list-style-type: none"> •Efficiency : 147lm/W (I_F 350mA, Ts 85°C), 126lm/W (I_F 700mA, Ts 85°C) •Low thermal resistance : 6°C/W •Lead-free soldering compatible •RoHS compliant

Recommended Applications

- Light source for general lighting etc.

Outline Dimensions

GBHW1106ASE-65X-TR

Unit : mm
 Weight : 22mg
 Tolerance : ±0.1

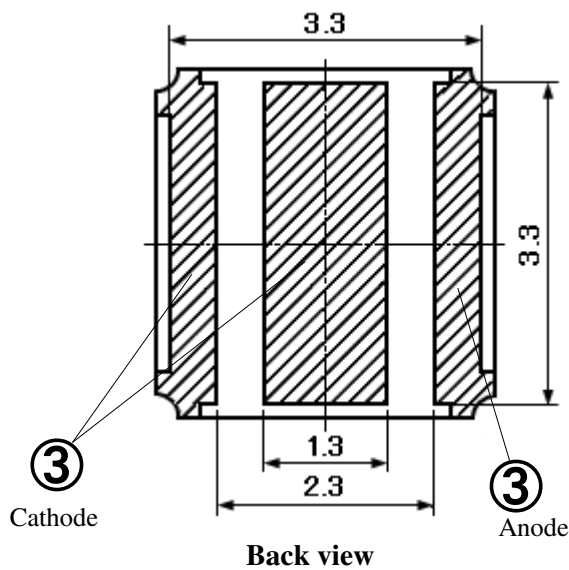
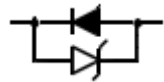
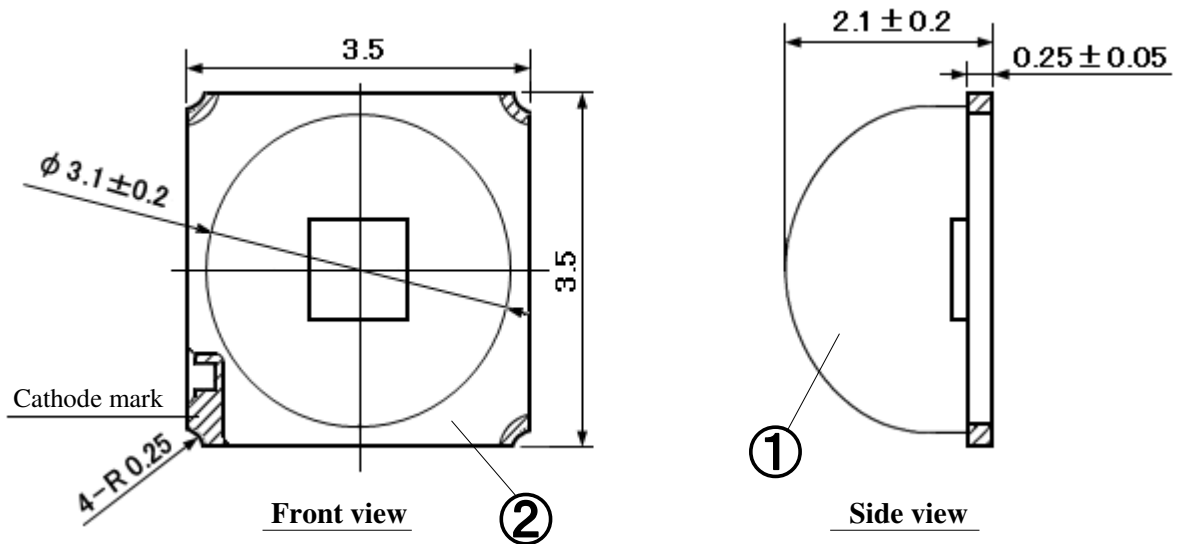

No.	Item	Material	Qty.
-	LED Die	InGaN	1
-	Protection diode	Si	1
①	Encapsulant	Silicone Resin	1
②	PCB	Glass fabrics	1
③	Electrode	Au Plating	Cathode:2 Anode:1

Recommended soldering Pattern

GBHW1106ASE-65X-TR

Unit : mm
Tolerance : ±0.1

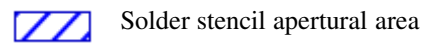
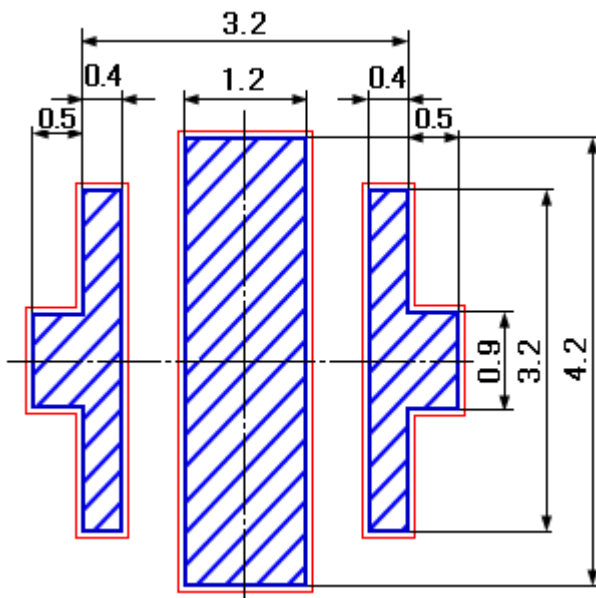
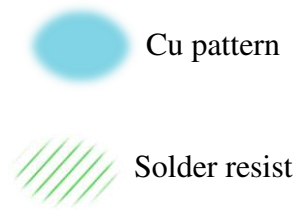
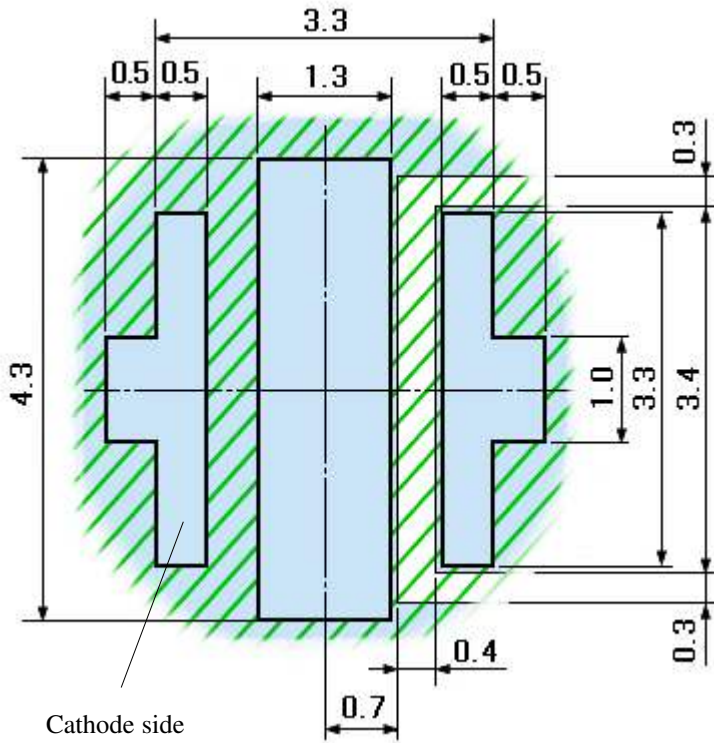

Recommended solder stencil thickness : 150μm

Specifications

GBHW1106ASE-65X-TR

【 Product Overview 】

DIE MATERIAL	InGaN
EMITTING COLOR	White
RESIN COLOR	Diffused pale yellow

【 Absolute Maximum Ratings 】

ITEM	SYMBOL	MAXIMUM RATINGS	UNITS	
Power Dissipation	P_d	4,000	mW	
Forward Current	I_F	1,000	mA	Notes 1
I_F Derate Linearly from "110°C"	ΔI_F	24	mA/°C	
Allowable Reverse Current	I_R	85	mA	
Operating Temperature	T_{opr}	-30 ~ +85	°C	Notes 2
Storage Temperature	T_{stg}	-30 ~ +100	°C	Notes 2
Electro Static Discharge Threshold "HBM"	ESD	1,000	V	Notes 3
Junction Temperature	T_j	150	°C	
Solder Point Temperature	T_s	130	°C	Notes 4
Soldering Temperature "Reflow Soldering"	T_{sld}	260	°C	Notes 5

Notes 1 The standard current value (= 350mA) is recommended to drive this LED.

Less than 100mA drive cannot be guaranteed any specifications.

Notes 2 The range of operating and storage temperature are not taping condition.

Notes 3 ESD testing method : EIAJ4701/300(304) Human Body Model (HBM) 1.5kΩ, 100pF

Notes 4 Junction - Solder point (measurement point)

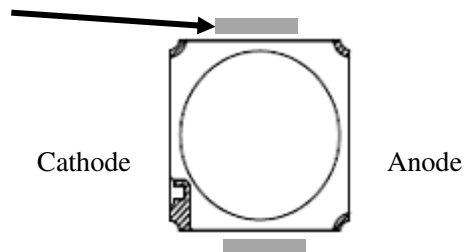

Notes 5 Please refer to page 11, "Soldering Conditions". And **the baking is unnecessary.**

【 Thermal Characteristics 】

ITEM	SYMBOL	TYP.	UNITS
Thermal resistance 【Junction - Solder point】	$R_{th(j-s)}$	6	°C/W

Specifications

GBHW1106ASE-65X-TR

【 Electro-Optical Characteristics 】

							(Ts=25°C)
ITEM	SYMBOL	CONDITIONS	MIN.	TYP.	MAX.	UNITS	
Forward Voltage	V_F	$I_F = 350\text{mA}$	2.70	2.85	3.25	V	Notes6
Reverse Voltage	V_R	$I_R = 10\text{mA}$	0.6	-	-	V	Notes7
Luminous Flux	ϕ_V	$I_F = 350\text{mA}$	100	156	200	lm	Notes6
Luminous Flux	ϕ_V	$I_F = 350\text{mA}$ $T_s = 85^\circ\text{C}$	-	144	-	lm	
Efficiency	-	$I_F = 350\text{mA}$ $T_s = 85^\circ\text{C}$	-	147	-	lm/W	
Luminous Flux	ϕ_V	$I_F = 700\text{mA}$ $T_s = 85^\circ\text{C}$	-	256	-	lm	
Efficiency	-	$I_F = 700\text{mA}$ $T_s = 85^\circ\text{C}$	-	126	-	lm/W	
Chromaticity coordinates	x	$I_F = 350\text{mA}$	-	0.313	-	/	Notes6,8
	y		-	0.329	-		
Half Intensity Angle	$\Delta\theta_x$	$I_F = 350\text{mA}$	-	120	-	deg.	Notes9
	$\Delta\theta_y$		-	120	-		
General Color Rendering Index	Ra	$I_F = 350\text{mA}$	-	70	-	/	
Color Temperature	-	$I_F = 350\text{mA}$	-	6,500	-	K	

Notes6 Please refer to the attached sheets, each sorting chart.

Notes7 Please do not input reverse voltage for prevent the destruction by static electricity.

Notes8 Chromaticity coordinates ; x and y according to CIE1931.

Notes9 Viewing Angle at 50% Iv.

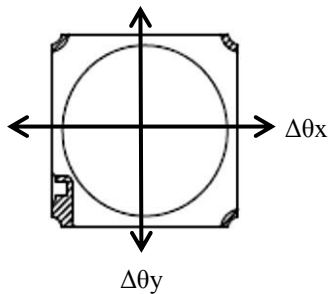

Specifications

GBHW1106ASE-65X-TR

【 Sorting chart for Luminous flux, Φ_V 】

LEDs shall be sorted out into the following chart and each rank parts shall be packed separately when shipping.

Rank	Luminous Flux Φ_V (lm)		Condition
	Min.	Max.	
C1	100	125	$T_s = 25^\circ\text{C}$ $I_F = 350\text{mA}$
C2	125	150	
C3	150	175	
C4	175	200	

Notes : Luminous flux Tolerance each Rank: $\pm 10\%$

【 Sorting chart for Forward Voltage Characteristics, V_F 】

LED's shall be "Forward Voltage" sorted out into the following chart and each rank parts shall be packed separately when shipping.

Rank	V_F (V)		Condition
	Min.	Max.	
A	2.70	3.00	$T_s = 25^\circ\text{C}$ $I_F = 350\text{mA}$
B	3.00	3.25	

Notes : Voltage tolerance each rank; $\pm 0.1\text{v}$

Specifications

GBHW1106ASE-65X-TR

【 Sorting chart for Chromaticity coordinates 】

LED's shall be "Chromaticity coordinates" sorted out into the following chart and each rank parts shall be packed separately when shipping.

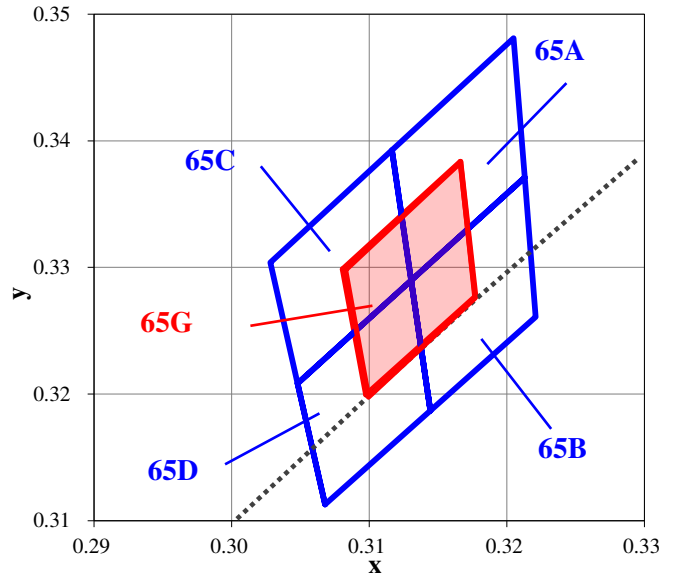
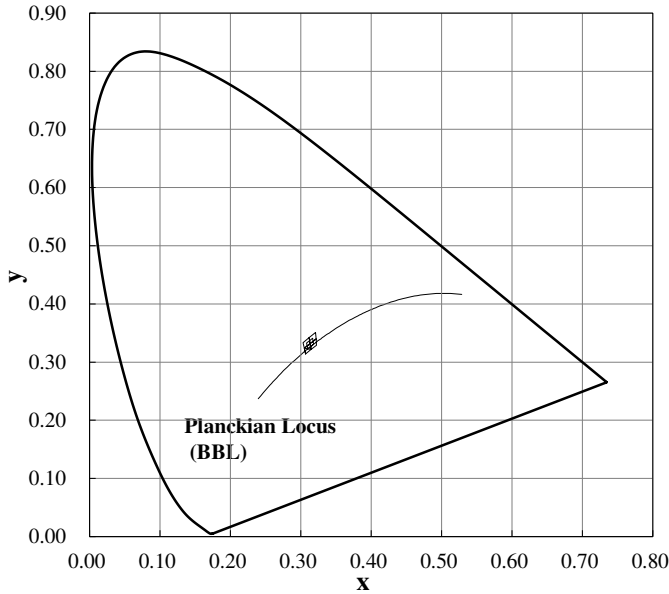

General color temperature		
6,500K (6,020K~7,040K)		

(Ts=25°C I_F=350mA)

Rank	x	y
65A	0.3131	0.3290
	0.3117	0.3393
	0.3205	0.3481
	0.3213	0.3371

Rank	x	y
65B	0.3145	0.3187
	0.3131	0.3290
	0.3213	0.3371
	0.3221	0.3261

Rank	x	y
65C	0.3048	0.3209
	0.3028	0.3304
	0.3117	0.3393
	0.3131	0.3290

Rank	x	y
65D	0.3068	0.3113
	0.3048	0.3209
	0.3131	0.3290
	0.3145	0.3187

Rank	x	y
65G	0.3098	0.3200
	0.3081	0.3299
	0.3166	0.3384
	0.3177	0.3277

Notes

- Chromaticity Coordinates Tolerance each Rank : ±0.01
- Chromaticity rank will ship by 5 ranks (Rank A,B,C,D,G). Rank G might also be shipped as Rank A, B, C, or D. Because Rank G share a same chromaticity area with A, B, C, and D.

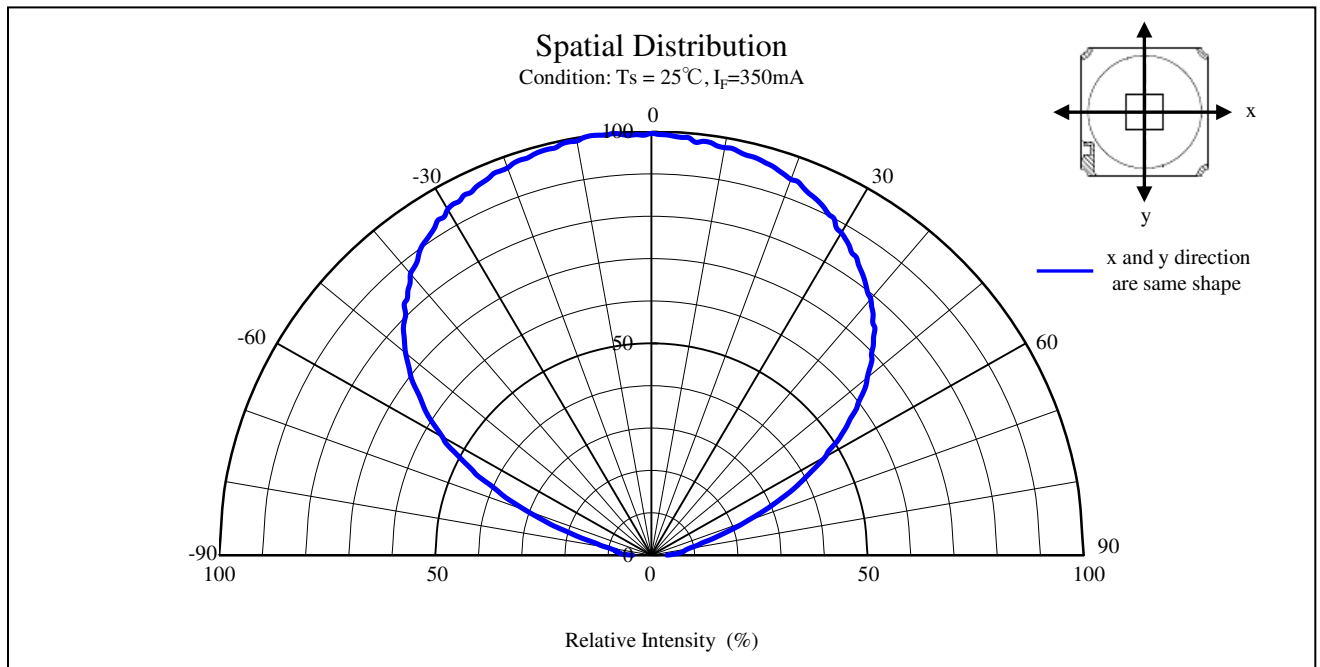
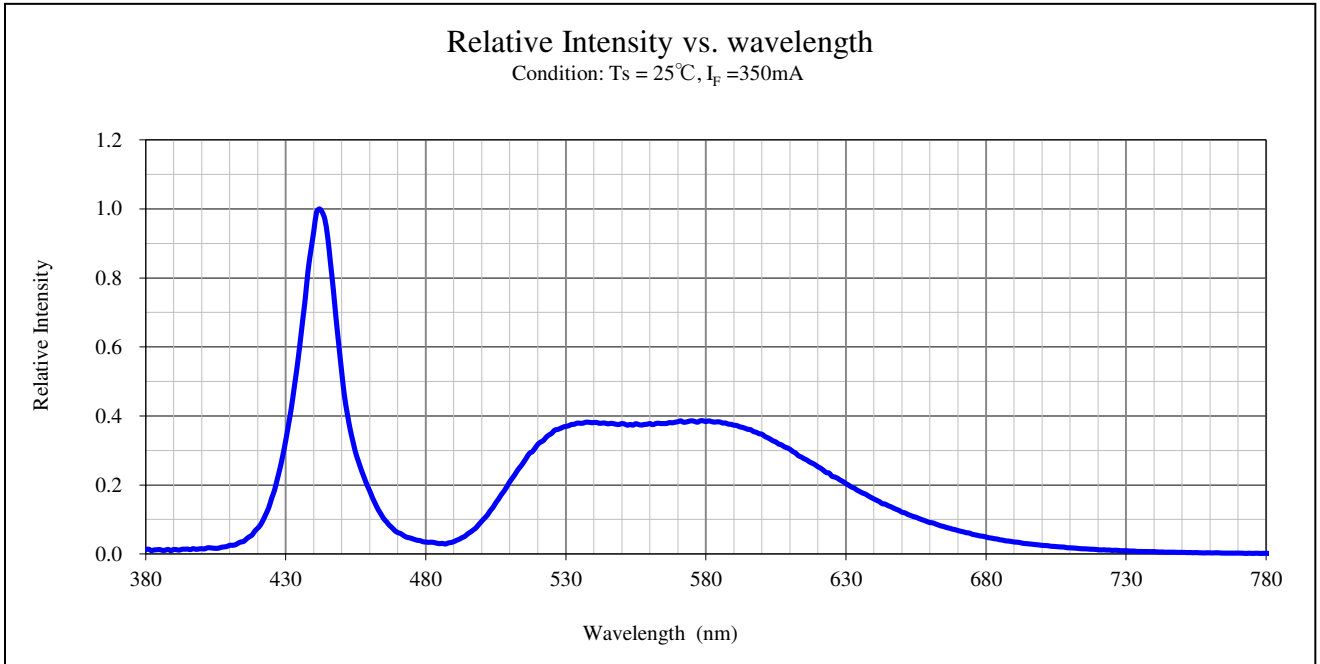

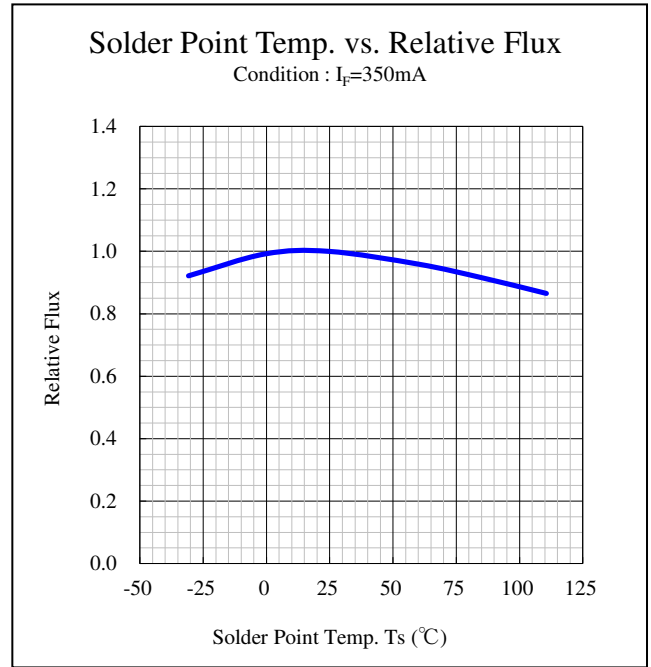
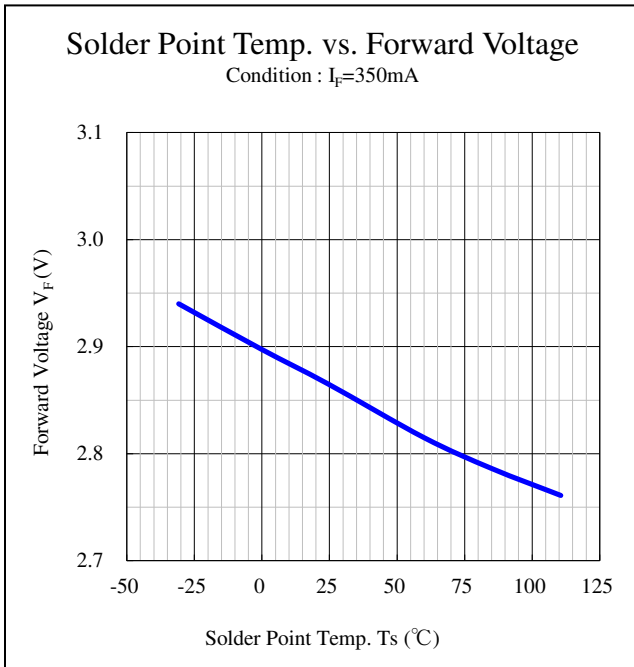
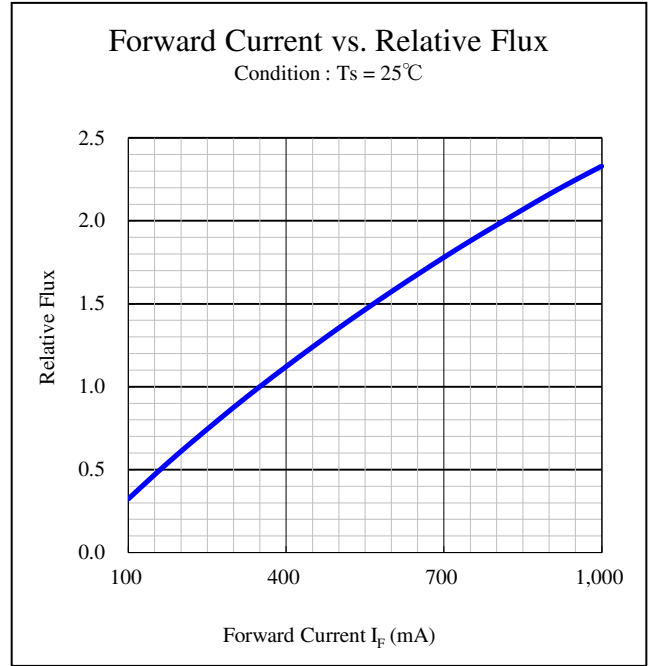
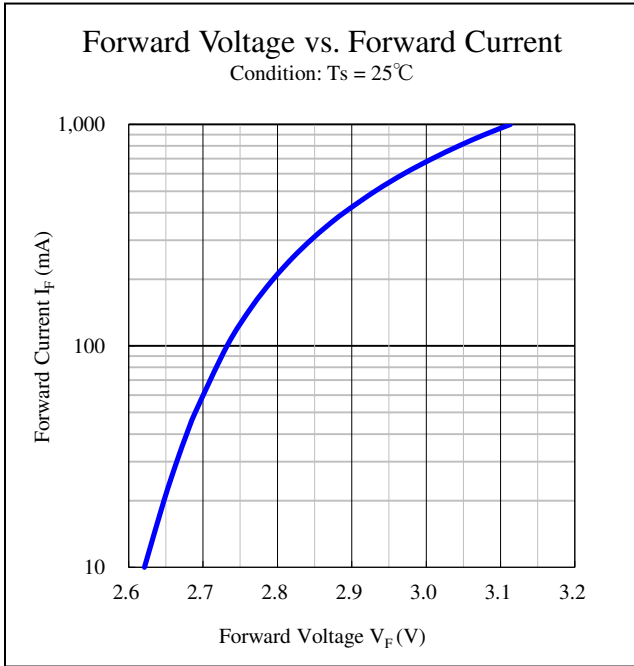

Technical Data

GBHW1106ASE-65X-TR

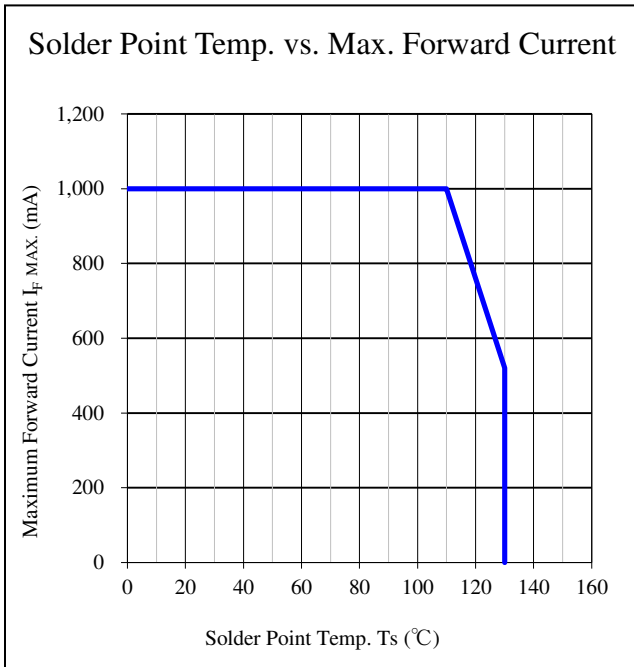
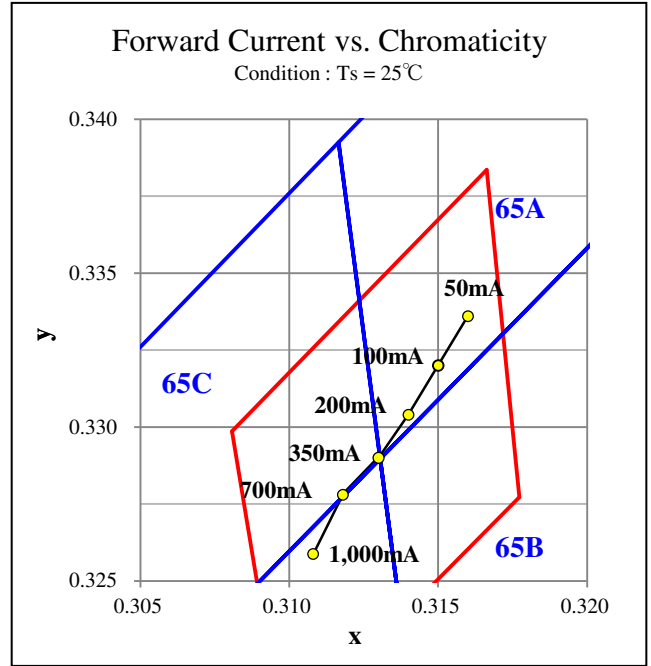
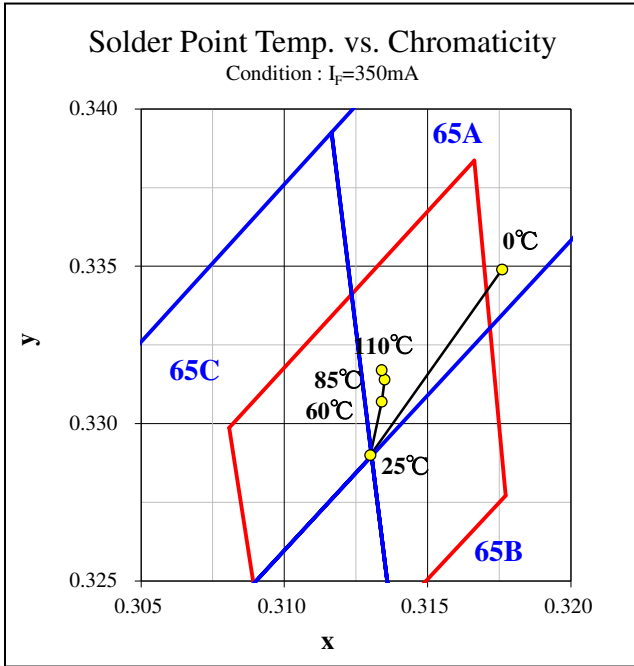

【Soldering Precaution】

(acc.to EIAJ-4701/300)

1. Heat stress during soldering will influence the reliability of LEDs, however that effect will vary on heating method. Also, if components of varying shape are soldered together, it is recommended to set the soldering pad temperature according to the component most vulnerable to heat (e.g., surface mount LED).
2. LED parts including the resin are not stable immediately after soldering (when they are not at room temperature), any mechanical stress may cause damage to the product. Please avoid such stress after soldering, especially stacking of the boards which may cause the boards to warp and any other types of friction with hard materials.
3. Recommended temperature profile for the Reflow soldering is listed as the temperature of the resin surface. Temperature distribution varies on heating method, PCB material, other components in the assembly, and mounting density .
Please do not repeat the heating process in Reflow process more than twice.

【 Recommended Reflow Soldering Condition 】

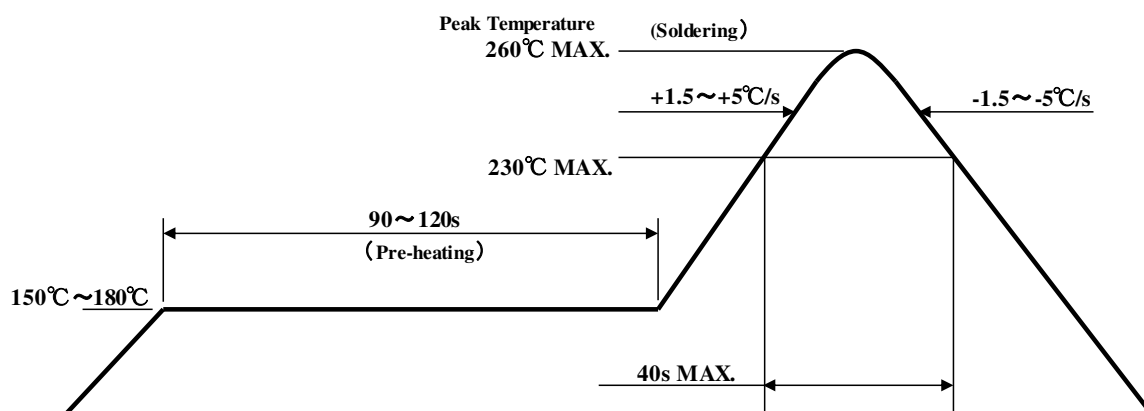

Notes 1

Temperature Profile for the reflow should be set to the surface temperature of resin which is on the top of LED. This should be the maximum temperature for soldering. Lowering the heating temperature and decreasing heating time is very effective in achieving higher reliability.

Notes 2

The reflow soldering process should be done up to twice(2 times Max). When second process is performed, interval between first and second process should be as short as possible to prevent absorption of moisture to resin of LED. The second soldering process should not be done until LEDs have returned to room temperature (by nature-cooling) after first soldering process.

4. If soldering manually, Stanley recommends using a soldering iron equipped with temperature control. During the actual soldering process, make sure that the soldering iron never touches the LED itself, and avoid the LED's electrode heating temperature reaching above the heating temperature of the solder pad. All repairs must be performed only once in the same spot, and please avoid reusing components.
5. In soldering process, immediately after iron tip is cleaned, please make sure that the soldering iron reaches the appropriate temperature, before using. Also, please avoid applying any types of pressure to the soldered components before the solder has been cooled and hardened, as it may deteriorate solder performance and solder quality.

【Recommended Manual Soldering Condition】

Temperature of Iron Tip	350°C MAX.
Soldering Duration, Time	3sec. Max., 1 time

6. When using adhesive material for tentative fixatives, thermosetting resin or Ultraviolet radiation (UV) setting resin with heat shall be recommended.
7. Flow soldering (dip soldering) is not recommended for this product.
8. Please confirm in advance there is no problem by assessment on your side if cleaning process is necessary. We can not accept any quality issues caused by the cleaning process.
As this product uses the low hardness silicone resin for the lens, please avoid cleaning to give pressure on the surface of the resin.
Please make sure ultrasonic cleaning is not recommended for this product as well.
Some chemicals, including Freon substitute detergent could corrode the lens or the casing surface, which cause discoloration, cloud, crack and so on. Please review the reference chart below for cleaning.
If water is used to clean (including the final cleaning process), please use pure water (not tap water), and completely dry the component before using.

Cleaning agents	Recommended / Not recommended
Pure water	✓ Recommended
Ethyl alcohol	x Not recommended
Isopropyl alcohol	x Not recommended
Trichloroethylene	x Not recommended
Chloroethene	x Not recommended
Acetone	x Not recommended
Thinner	x Not recommended

【For Electric Static Discharge (ESD)】

This kind of LED lamp is highly sensitive to surge voltage generated by the On/Off status change and discharges of static electricity through frictions with synthetic materials, which may cause severe damage to the die or undermine its reliability. Damaged products may experience conditions such as extremely high reverse voltage, or a decrease of forward rise voltage, deteriorating its optical characteristic.

Stanley products are designed to withstand up to 1,000V under the EIAJ ED-4701/300 Test #304 (HBM), and are packed with anti-static components. However, the following precautions and measures are vital in ensuring product quality during shipment.

EIAJ ED-4701/300 (304/HBM) Electrification model: $C=100\text{pF}$, $R_2=1.5\text{K}\Omega$

1. Electrification/Static Electricity protection

Stanley recommends the following precautions in order to avoid product (die) damage from static electricity, when an operator and other materials electrified by friction coming in contact with the product.

- ① Do not place electrified non-conductive materials near the LED product.
Avoid LED products from coming into contact with metallic materials.(Should the metallic material be electrified, the sudden surge voltage will most likely damage the product.)
- ② Avoid a working process which may cause the LED product to rub against other materials.
- ③ Install ground wires for any equipment, where they can be installed, with measures to avoid static electricity surges.
- ④ Prepare a ESD protective area by placing a Conductive Mattress (1M Ω MAX.) and Ionizer to remove any static electricity.
- ⑤ Operators should wear a protective wrist-strap.
- ⑥ Operators should wear conductive work-clothes and shoes.
- ⑦ To handle the products directly, Stanley recommends the use of ceramic, and not metallic, tweezers.

2. Working Environment

- ① A dry environment is more likely to cause static electricity. Although a dry environment is ideal for storage state of LED products, Stanley recommends an environment with approximately 50% humidity after the soldering process.
- ② Recommended static electricity level in the working environment is less than 150V, which is the same value as Integrated Circuits (which are sensitive to static electricity).

【Other Precautions】

1. The products are designed to achieve higher performance reliability, however, they can be influenced by usage conditions.
2. Absolute maximum ratings are set to prevent LED products from failing due to excess stress (temperature, current, voltage, etc.). These ratings must never be overrun even for a moment.
3. In order to ensure high reliability from LED Lamps, variable factors that arise in actual usage conditions should be taken into account for designing. (Derating of TYP., MAX Forward Voltage, etc.)
4. Please insert Straight Protective Resistors into the circuit in order to stabilize LED operation and to prevent the device from igniting due to excess current.
5. Please check the actual performance in the assembly because the Specification Sheets are described for LED device only.
6. Please refrain from looking directly at the light source of LED at high output, as it may harm your vision.
7. The products are designed to operate without failure in recommended usage conditions. However, please take the necessary precautions to prevent fire, injury, and other damages should any malfunction or failure arise.
8. The products are manufactured to be used for ordinary electronic equipment. Please contact our sales staff beforehand when exceptional quality and reliability are required, and the failure or malfunction of the products might directly jeopardize life or health (such as for airplanes, aerospace, transport equipment, medical applications, nuclear reactor control systems and so on).
9. When there is a process of supersonic wave welding etc. after mounting the product, there is a possibility of affecting the reliability of junction part in package (junction part of die bonding and wire bonding). Please make sure there is no problem before using.
10. Please avoid the stick of foreign material because molding resin in the products has adhesiveness.
11. Please avoid overload to the product when using tweezers to pick up LEDs. Overload might cause deformation, disconnection, chip-outs and consequently lead to lighting failure. Tweezers with flat tips is recommended, please avoid using tweezers with sharp tips.
12. Low hardness resin is used on the bottom of lens. Please avoid overload to the surface of lens which might cause chip-outs, encapsulant delamination, and deformation, nicks, wire disconnection and decreasing reliability. Be careful when dealing with the products and pay attention to following points.
 - During mounting process, keep lens from coming in contact with absorbing nozzle and refer to precautions on next page.
 - Pay attention to handling and storage of LEDs even after mounting, because overload caused by stacking PCBs and shock due to dropping and crashing might also lead to deformation, disconnection, and chip-outs.
 - In the processes of water pressure during cleaning, air pressure, drying and other processes after mounting, overload to lens should be avoided.
13. This type of product is not water proof and moisture proof nor with salt corrosion protection, therefore attention should be paid when products are used under such conditions.
14. The formal specification sheets shall be valid only by exchange of documents by both parties.

【Handling Precautions for Product Mounting】

<Recommendation>

1. Pick up point : The surrounding of the LED (area) (Shown below)

Pick up should only be limited to the surrounding of LED.
 (If the nozzle makes contact with the lens, the products might be damaged.)

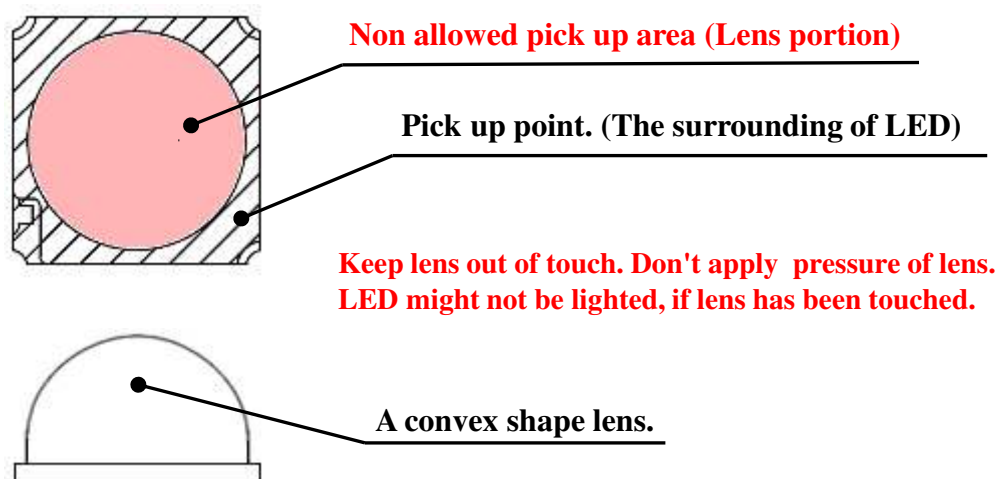

Please adjust the load, the pick up point, the nozzle diameter, etc. before mounting because the over load can cause the breakage of the surrounding of LED.

Recommendation of nozzle

- Internal diameter of nozzle : $\phi 3.3\text{mm}$ • External diameter of nozzle : $\phi 3.7\text{mm}$
- Pick-up position of nozzle : From the top of emboss tape
- If nozzle size is larger than opening part of emboss tape, pick-up should be done 0.1mm upper from emboss tape, or you can set holes (so that air can leak) on nozzle.

This type of LED contains silver. If LED is stored in an environment that generate excess corrosive gas, it might affect product performance due to silver corrosion. Therefore Stanley recommends moisture-proof packaging and dry-box for storage. Also following storage condition is recommended.

Cardboard box packaging is used for transportation. A lot of cases where the out gas including the element to make them corrode silver processed from the corrugated cardboard used for packing and rubber is generated are reported. (reduction property sulfur gas composition chiefly:H₂S, S₈, CH₃SH, etc.) The products should be isolated from the corrugated cardboard and the rubber in keeping.

Moisture-proof bag as the packaging is made of anti-static material, while packaging box is not.

【Recommended Storage Condition / Products Warranty Period】

Temperature	+5~30°C
Humidity	Under 70%

In the case of the package unopened , 6 months under 【 Recommended Storage Condition 】. Please avoid rapid transition from low temp. condition to high temp. condition and storage in corroding and dusty environment.

【Time elapsed after Package Opening】

If any LED remain unused, please put it back to moisture-proof bag, reseal the package and store it under the conditions described in 【Recommended Storage Condition】. When over 6 months passed after first opening of package, please do confirm the solder wettability of the terminals.

**Baking (moisture removal) is unnecessary for this product.
Please do not bake LEDs with carrier tape.**

【Moisture-proof Packaging Specification】

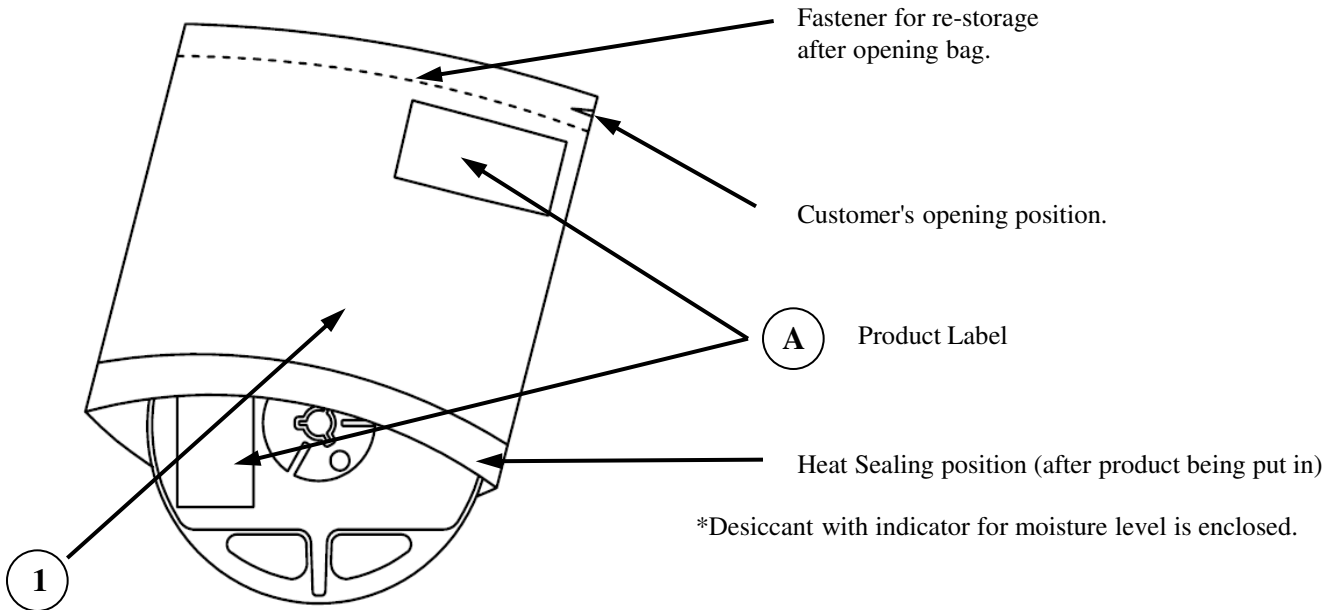

NO.	PART NAME	MATERIALS	REMARKS
①	Moisture-proof bag with Aluminum layer	PET+Al+PE	with ESD protection

Packaging Specifications

GBHW1106ASE-65X-TR

【Packing box】

(RoHS•ELV Compliant)

Box TYPE	Outline dimension L × W × H (mm)	Capacity of the box
Type A	280 × 265 × 45	3 reel
Type B	310 × 235 × 265	15 reel
Type C	440 × 310 × 265	30 reel

Notes1 : The above measure is all the reference value.

Notes2 : The box is selected out of the above table by shipping quantity.

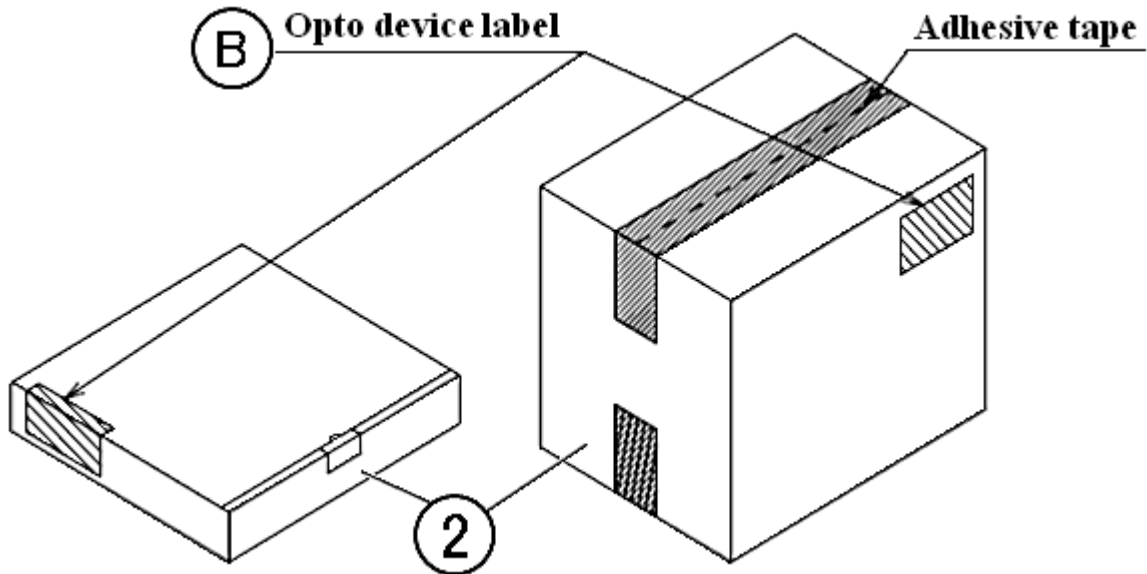

Type A

Material / box : Cardboard C5BF

Type B,C

Material / box : Cardboard K5AF

Partition : Cardboard K5BF

NO.	PART NAME	MATERIAL	REMARKS
②	Packing Box	Corrugated Cardboard	without ESD protection

(acc.to JIS-X0503(Code-39))

【Label Specification】

A Product label

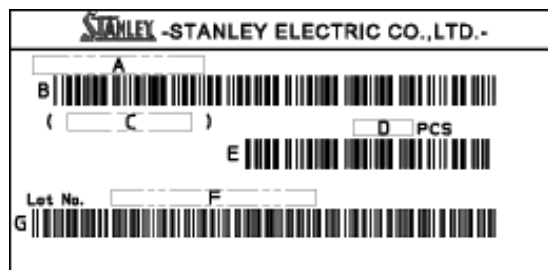

- A. Parts number
 - B. Bar-code for parts number
 - C. Parts code (In-house identification code for each parts number)
 - D. Packed parts quantity
 - E. Bar-Code for packed parts quantity
 - F. Lot number & Rank
- (Please refer to Lot Number Notational System for details)
- G. Bar-Code for Lot number & Rank

B Opto device label

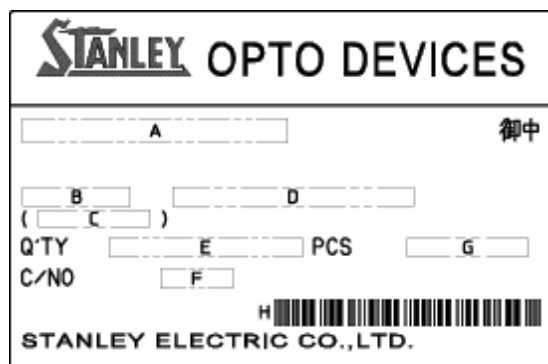

- A. Customer Name
- B. Parts Type
- C. Parts Code
- D. Parts Number
- E. Packed Parts Quantity
- F. Carton Number
- G. Shipping Date
- H. Bar-Code for In-house identification Number

Notes Bar-code font : according to Code-39 (JIS-X0503)

Taping and Reel Specifications

GBHW1106ASE-65X-TR

(acc.to JIS-C0806-03)

【Appearance】

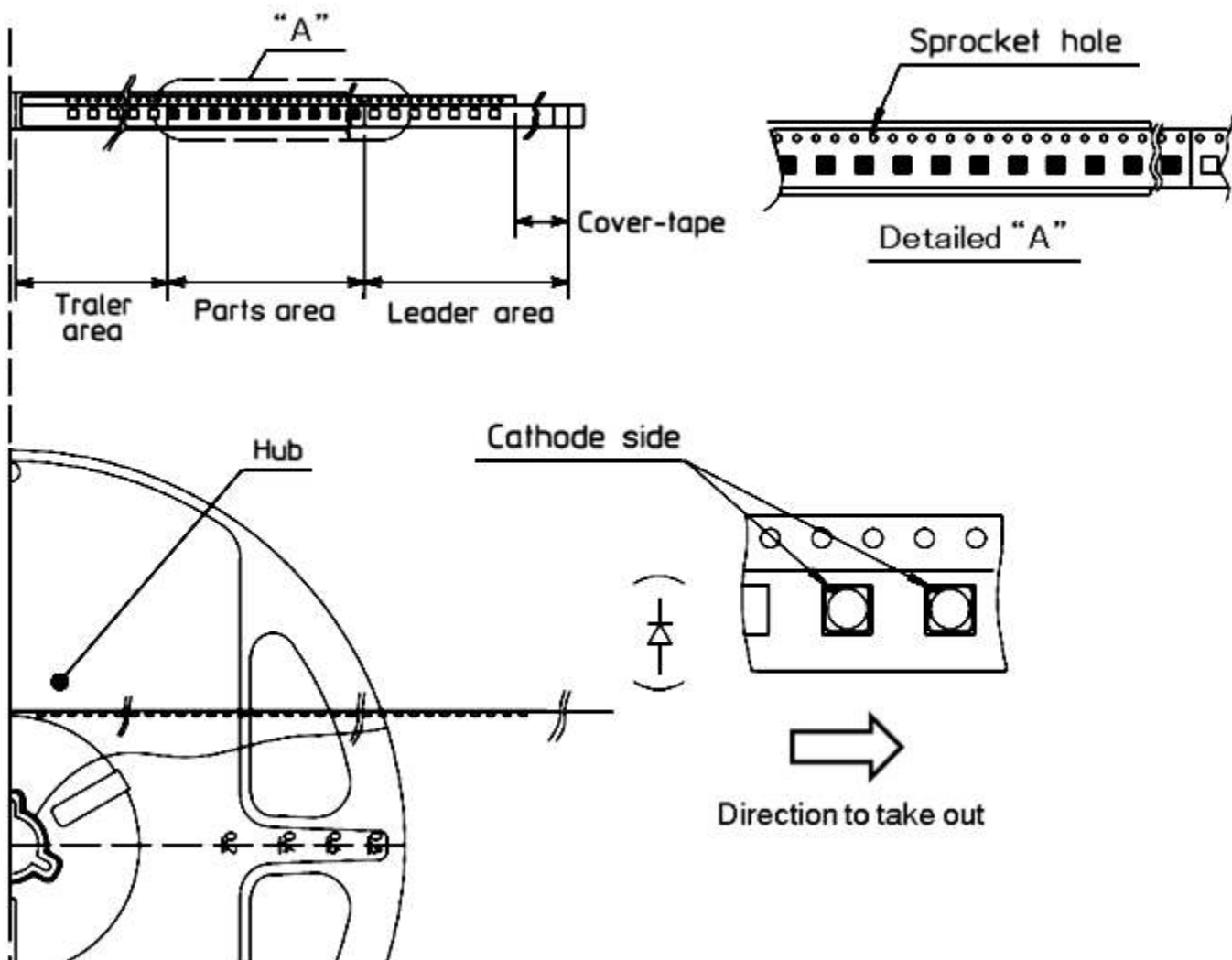

Note

"-TR" means Cathode Side of LEDs should be placed on the sprocket-hole side.

Items		Specifications	Remarks
Leader area	Cover-tape	Cover-tape shall be longer than 320mm without carrier-tape	The end of cover-tape shall be held with adhesive tape.
	Carrier-tape	Empty pocket shall be more than 13 pieces (100mm) .	Please refer to the above figure for Taping & reel orientation .
Trailer area		Empty pocket shall be more than 20 pieces (160mm) .	The end of taping shall be inserted into a slit of the hub.

Taping and Reel Specifications

GBHW1106ASE-65X-TR

(acc.to JIS-C0806-03)

Unit :mm

【Taping Dimensions】

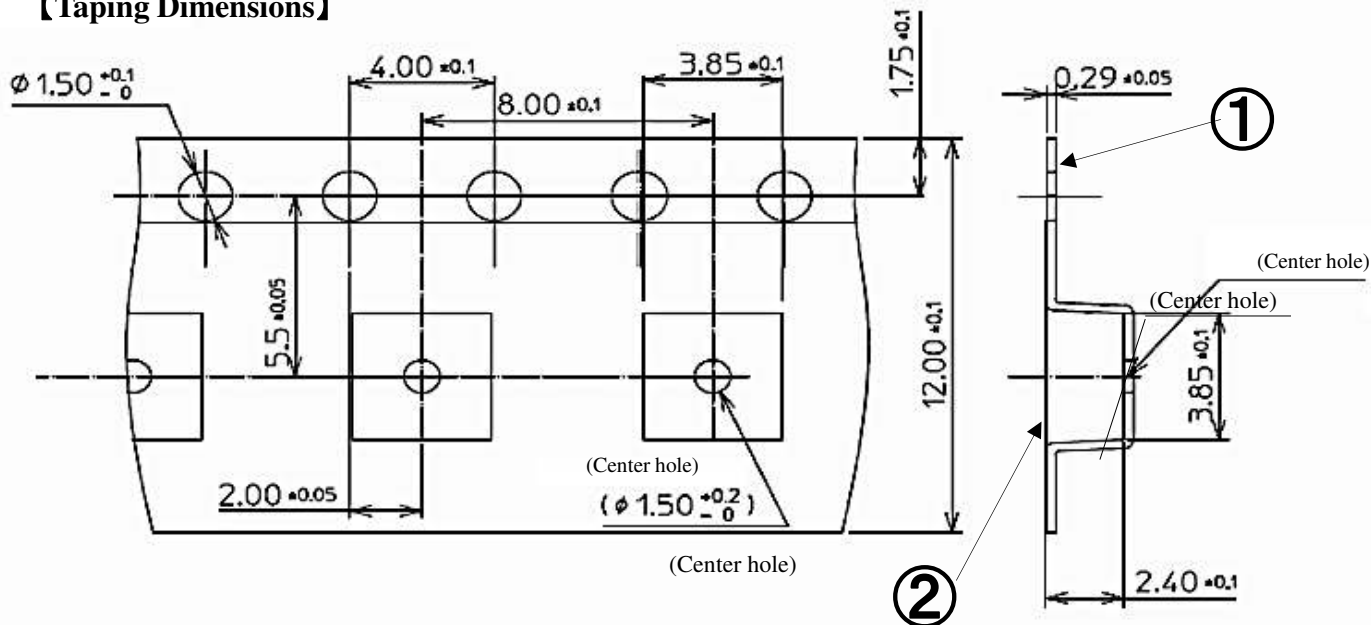

【Reel Dimensions】

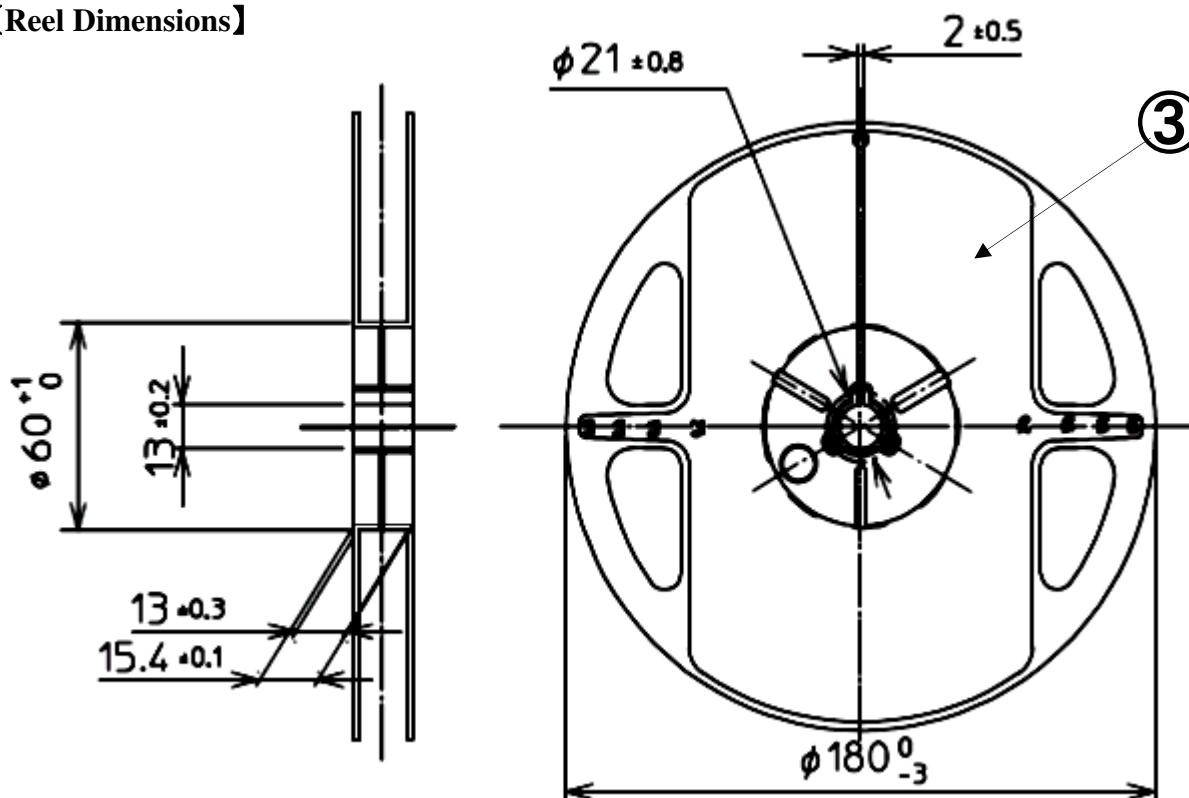

NO.	PART NAME	REMARKS
①	Carrier-tape	Anti-Static Grade
②	Cover-tape	Anti-Static Grade
③	Carrier-reel	Anti-Static Grade

Taping and Reel Specifications

GBHW1106ASE-65X-TR

(acc.to JIS-C0806-03)

【 Qty. per Reel】

- 500parts/reel

【Mechanical strength】

- Cover-tape adhesive strength shall be 0.1 ~ 1.4N (An angle between carrier-tape and cover-tape shall be 170 deg.).
- Both tapes shall be so sealed that the contained parts will not come out from the tape when it is bent at a radius of 15mm.

【 Others】

- Reversed-orientation, Up-side down placing, side placing and out of spec. parts mix shall not be held.
- Max qty. of empty pocket per reel shall be defined as follows.

Qty./reel	Max. qty. of empty pocket	Remarks
500	1	-

Lot Number Notational System

GBHW1106ASE-65X-TR

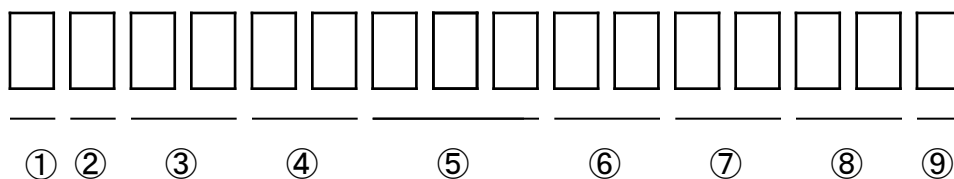

- ① - 1digit : Production location (alphabet)
- ② - 1digit : Production year (the last digit of production year shall be indicate as 2018→8, 2020→0 ,2021→1,···)
- ③ - 2digits : Production month (Jan. to Sep. ,shall be indicated as 01,02,03,·····)
- ④ - 2digits : Production date
- ⑤ - 3digits : Serial number
- ⑥ - 2digits : Tape and reel following number
- ⑦ - 2digits : Luminous flux rank.
(If luminous flux rank is 1 digit, "-" shall be dashed on the place for the second digit.
If there is no identified rank, "- -" shall be used to indicate.)
- ⑧ - 2digits : Chromaticity rank
(If chromaticity rank is 1 digit, "-" shall be dashed on the place for the second digit.
If there is no identified rank, "- -" shall be used to indicate.)

Indicated on label	Chromaticity rank
8A	65A
8B	65B
8C	65C
8D	65D
8G	65G

- ⑨ - 1digit : V_F rank (If there is no identified rank, "-" shall be used to indicate.)

This product is in compliance with RoHS・ELV.

Prohibition substance and it's criteria value of RoHS・ELV are as follows.

- RoHS instruction Refer to following (1)~(6).
- ELV instruction Refer to following (1)~(4).

	Substance Group Name	Criteria Value
(1)	Lead and its compounds	1,000ppm Max
(2)	Cadmium and its compounds	100ppm Max
(3)	Mercury and its compounds	1,000ppm Max
(4)	Hexavalent chromium	1,000ppm Max
(5)	PBB	1,000ppm Max
(6)	PBDE	1,000ppm Max

Reliability Testing Result

GBHW1106ASE-65X-TR

1. Reliability Testing Result

Test Item	Standard	Test Condition	Duration	Failure
Room Temperature Operating Life	EIAJ ED-4701 /100(101)	Ta=25°C I _F =1,000mA	1,000h	0 / 16
High Temperature Operating Life	EIAJ ED-4701 /100(101)	Ta=85°C I _F =1,000mA	1,000h	0 / 16
Low Temperature Operating Life	EIAJ ED-4701 /100(101)	Ta=-40°C I _F =1,000mA	1,000h	0 / 16
Wet High Temperature Operating Life	EIAJ ED-4701 /100(102)	Ta=60°C 90% I _F =1,000mA	1,000h	0 / 16
Thermal Shock	EIAJ ED-4701 /100(105)	Ta=-30°C ~ 100°C (each 15min)	1,000 cycles	0 / 20
Resistance to Reflow Soldering	EIAJ ED-4701 /300(301)	Moisture Soak : 30°C 70% 168h Preheating : 150~180°C 90~120sec Soldering : 260°C Peak	2times	0 / 20
Electrostatic Discharge (ESD) ※1	EIAJ ED-4701 /300(304)	C=100pF R2=1.5kΩ +/-2,000V	once of each polarity	0 / 20

※1 Reference test

2. Failure Criteria

Item	Symbol	Condition	Failure Criteria
Luminous Intensity	I _V	I _F =100mA	Testing Min. Value < Standard Min. Value × 0.7
Forward Voltage	V _F	I _F =100mA	Testing Max. Value ≥ Standard Max. Value × 1.2
External appearance	-	-	Notable discoloration, deformation and cracking

Special Notice to Customers Using the Products and Technical Information Shown in This Data Sheet

- 1) The technical information shown in the data sheets are limited to the typical characteristics and circuit examples of the referenced products. It does not constitute the warranting of industrial property nor the granting of any license.
- 2) For the purpose of product improvement, the specifications, characteristics and technical data described in the data sheets are subject to change without prior notice. Therefore it is recommended that the most updated specifications be used in your design.
- 3) When using the products described in the data sheets, please adhere to the maximum ratings for operating voltage, heat dissipation characteristics, and other precautions for use. We are not responsible for any damage which may occur if these specifications are exceeded.
- 4) The products that have been described to this catalog are manufactured so that they will be used for the electrical instrument of the benchmark (OA equipment, telecommunications equipment, AV machine, home appliance and measuring instrument).
The application of aircrafts, space borne application, transportation equipment, medical equipment and nuclear power control equipment, etc. needs a high reliability and safety, and the breakdown and the wrong operation might influence the life or the human body. Please consult us beforehand if you plan to use our product for the usages of aircrafts, space borne application, transportation equipment, medical equipment and nuclear power control equipment, etc. except OA equipment, telecommunications equipment, AV machine, home appliance and measuring instrument.
- 5) In order to export the products or technologies described in this data sheet which are under the “Foreign Exchange and Foreign Trade Control Law,” it is necessary to first obtain an export permit from the Japanese government.
- 6) No part of this data sheet may be reprinted or reproduced without prior written permission from Stanley Electric Co., Ltd.
- 7) The most updated edition of this data sheet can be obtained from the address below:
<http://www.stanley-components.com/en>