

SUMMARY

Wires

Low voltage 3



Image is for illustrative purpose only

Series 0B
Termination type Female solder
IP rating 50
AWG wire size 28.00 - 20.00
Cable Ø 0.00 - 0.00 mm
Status active
Matching parts [FGG.0B.303.CLAD52](#)

Download

[Request a quote](#)

[Catalog](#)

TECHNICAL DETAILS

Mechanics

Shell Style/Model EE*: Fixed receptacle, nut fixing (back panel mounting)
Keying 1 key (alpha=0, plug: male contacts, receptacle: female contacts)
Housing Material Brass (chrome plated [SAE AMS 2460]) shell and collet nut, nickel plated [SAE AMS QQ N 290] brass latch sleeve and mid pieces
Weight 5.04 g

Performance

Configuration 0B.303 : 3 Low Voltage
Insulator L: PEEK (UL 94 / V-0/1.5)
Rated Current 8 Amps

Specifications

Contact Type: Solder
Contact Dia.: 0.9 mm (0.035in)
Bucket Dia.: 1.0 mm (0.039in)
Max. Solid Conductor: 0.56 mm² (AWG 20)
Max. Stranded Conductor: 0.56 mm² (AWG 20)
R (max): 4.8 mOhm
Vtest (contact-shell): 900 V (AC), 1270 V (DC)
Vtest (contact-contact): 1200 V (AC), 1700 V (DC)

LEMO products and services are provided "as is". LEMO makes no warranties or representations with regard to LEMO product & services or use of them, express, implied or statutory, including for accuracy, completeness, or security. The user is fully responsible for his products and applications using LEMO components.

Others

Endurance (Shell): 5000
 Temp (min / max): -55°C / +250°C
 Humidity (max): <=95% [at 60 deg C / 140 F]
 Vibration: 15 g [10 Hz - 2000 Hz]
 Shock Resistance: 100 g [6 ms]
 Climatical Category: 50/175/21
 Shielding (min): 75 dB (10 MHz)
 Shielding (min): 40 dB (1 GHz)
 Salt Spray Corrosion: >1000 hr

DRAWINGS

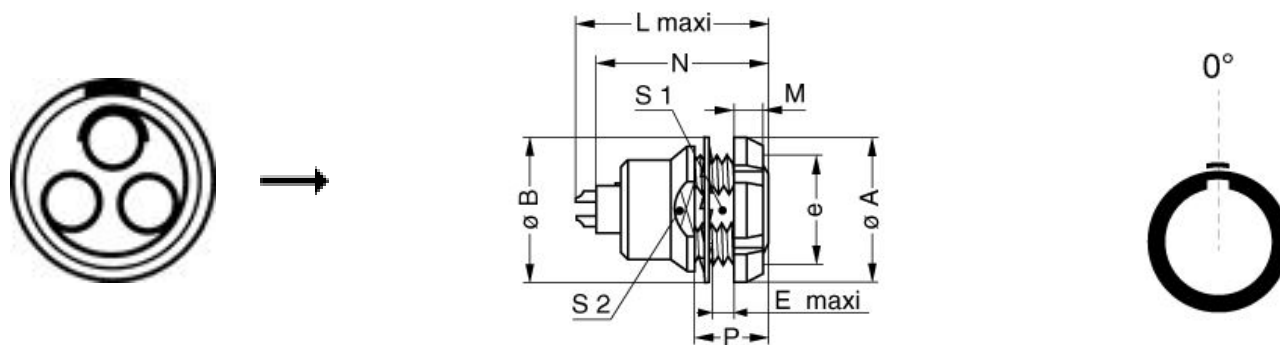

Dimensions

	A	B	E	L	M	N	P	S1	S2	e
mm.	12	12.5	2.4	20.7	2.5	19.1	6.3	8.2	9	M9x0.6
in.	0,47	0,49	0,09	0,81	0,10	0,75	0,25	0,32	0,35	













RECOMMENDED BY LEMO

Tools

Spanner wrench: [Socket for torque wrench DCM.05.M09.4](#)

LEMO products and services are provided "as is". LEMO makes no warranties or representations with regard to LEMO product & services or use of them, express, implied or statutory, including for accuracy, completeness, or security. The user is fully responsible for his products and applications using LEMO components.

Cables

CMN.03.T28.031PGCE	PVC	GREY	
CMN.03.T28.031PGZE		Grey	
CMN.03.T28.031PNCE	PVC	Black	
CMN.03.T28.031PNZE			
130240	PVC	Black	
130250	PVC	Grey	
30110	PVC	Grey	
30141	PVC	Grey	
30260	PVC	Black	
3041	PVC	Grey	
3050	PVC	Black	
3081	PVC	Black	
3220	PVC	Black	
3280	PVC	Black	
60080	PVC	Grey	

LEMO products and services are provided "as is". LEMO makes no warranties or representations with regard to LEMO product & services or use of them, express, implied or statutory, including for accuracy, completeness, or security. The user is fully responsible for his products and applications using LEMO components.