



RF360
Europe GmbH

Data sheet

BAW filter
6.5 GHz Wi-Fi 6E UNII5-8

Part number:	B8380
Ordering code:	B39652B8380L210
Date:	December 06, 2022
Version:	2.2

Qualcomm products mentioned herein are products of Qualcomm Technologies, Inc. and/or its subsidiaries.

RF360 Europe GmbH
Anzinger Straße 13
81671 Munich, Germany

© 2022 Qualcomm Technologies, Inc. and/or its subsidiaries. All rights reserved

These materials, including the information contained herein, may be used only for informational purposes by the customer. Qualcomm Technologies, Inc. and/or its subsidiaries assume no responsibility for errors or omissions in these materials or the information contained herein and reserve the right to make changes to the product(s) or information contained herein without notice. The materials and information are provided on an AS IS basis, without warranty, either expressed or implied, with respect to the materials, or any output or results based on the use, application, or evaluation of such materials, including without limitation, with respect to the non-infringement of trademarks, patents, copyrights or any other intellectual property rights or other rights of third parties.

No use of this documentation or any information contained herein grants any license, whether express, implied, by estoppel or otherwise, to any intellectual property rights, including, without limitation, to any patents owned by QUALCOMM Incorporated or any of its subsidiaries.

Not to be used, copied, reproduced, or modified in whole or in part, nor its contents revealed in any manner to others without the express written permission of RF360 Europe GmbH.

Qualcomm is a trademark or registered trademark of Qualcomm Incorporated. Other product and brand names may be trademarks or registered trademarks of their respective owners.

This technical data may be subject to U.S. and international export, re-export, or transfer ("export") laws. Diversion contrary to U.S. and international law is strictly prohibited.

Table of contents

1	Application	4
2	Features	4
3	Package	5
4	Pin configuration	5
5	Matching circuit	6
6	Characteristics	7
7	Maximum ratings	9
8	Transmission coefficient	10
9	Transmission coefficient (WLAN)	11
10	Reflection coefficients	14
11	Packing material	15
12	Marking	19
13	Soldering profile	20
14	Annotations	21
15	Cautions and warnings	22
16	ESD protection of acoustic devices	23
17	Important notes	24

1 Application

- Low-loss BAW RF 6.5GHz coexistence filter for Wi-Fi 6E (UNII5-8)
- Frequency range 5945-7125MHz/ Pass band 1180MHz
- Coexistence with UNII1-3
- Excellent Power Handling
- Small footprint

2 Features

- Package size $1.8_{\pm 0.05}$ mm \times $1.4_{\pm 0.05}$ mm
- Package height 0.64 mm (max.)
- Approximate weight 3 mg
- RoHS compatible
- Package for Surface Mount Technology (SMT)
- Ni/Au-plated terminals
- Electrostatic Sensitive Device (ESD)
- Moisture Sensitivity Level 3 (MSL3)

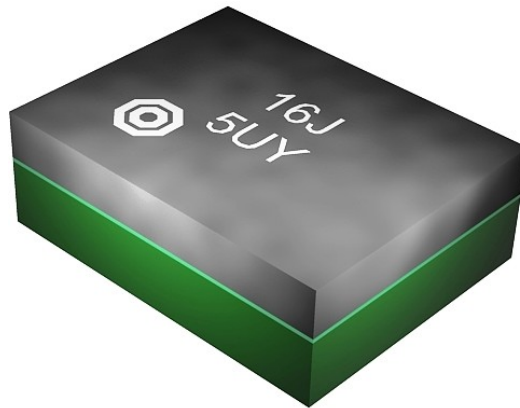
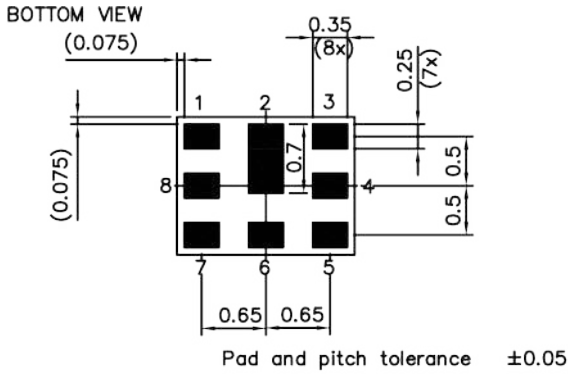
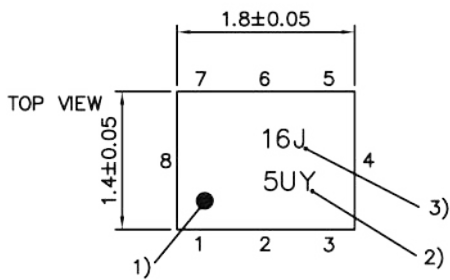
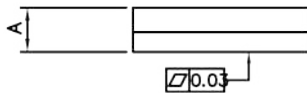

Figure 1: Picture of component with example of product marking.

3 Package



SIDE VIEW



- 1) Marking for pad number 1
- 2) Example of encoded lot number
- 3) Example of encoded filter type number

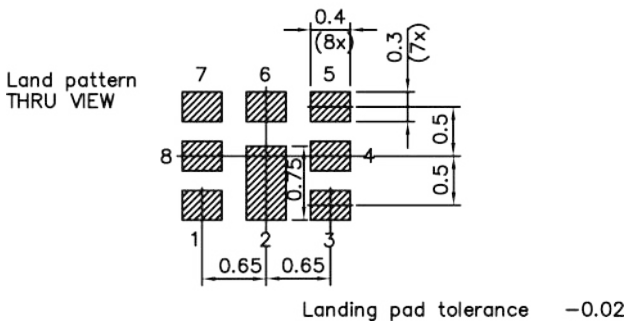

4 Pin configuration

- 3 Output
- 7 Input
- 1, 2, 4, 5, 6, 8 Ground

Figure 2: Drawing of package with package height $A = 0.64$ mm (max.). See Sec. Package information (p. 22).

5 Matching circuit

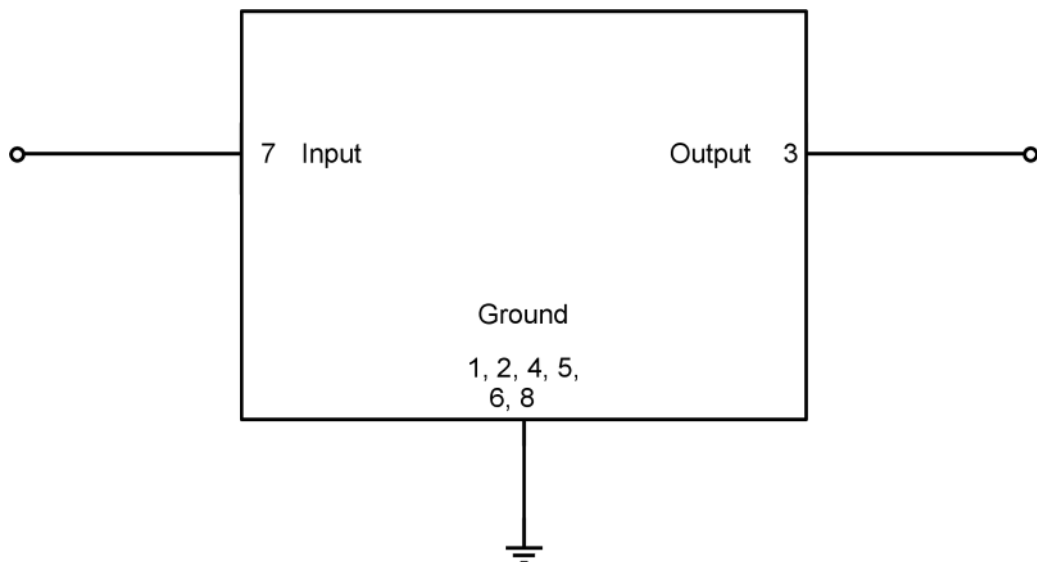

Figure 3: Schematic of matching circuit. No external matching components required.

6 Characteristics

Temperature range for specification	T_{SPEC}	= -30 °C ... +85 °C
Input terminating impedance	Z_{IN}	= 50 Ω
Output terminating impedance	Z_{OUT}	= 50 Ω

Characteristics				min. for T_{SPEC}	typ. @ +25 °C	max. for T_{SPEC}		
Maximum insertion attenuation				α_{max}	—	3.2	4.5	dB
	5945... 6105	MHz						
	6105... 7125	MHz		—	2.1	3.0		
Insertion attenuation – WLAN				$\alpha_{WLAN}^{1)}$	—	2.9	3.8	dB
	5945... 7125	MHz						
	5945... 7125	MHz						
	5945... 7125	MHz		$\alpha_{WLAN}^{2)}$	—	2.5	3.0	
	5945... 7125	MHz		$\alpha_{WLAN}^{3)}$	—	2.4	3.0	
Amplitude ripple (p-p)				$\Delta\alpha$	—	0.8	2.5	dB
	5945... 6105	MHz						
	6105... 7125	MHz		—	0.4	1.5		
Maximum VSWR				$VSWR_{max}$	—	1.7	2.5	
@ input port								
	5945... 6105	MHz						
	6105... 7125	MHz						
@ output port				—	1.4	2.2		
	5945... 6105	MHz		—	1.7	2.5		
	6105... 7125	MHz		—	1.4	2.2		
Minimum attenuation				α_{min}	40	44	—	dB
	10... 2000	MHz						
	2000... 2100	MHz						
	2100... 2400	MHz						
	2400... 2570	MHz						
	2570... 3400	MHz						
	3400... 3870	MHz						
	3870... 4400	MHz						
	4400... 5170	MHz						
	5170... 5725	MHz						
	5725... 5825	MHz						
	11890... 14250	MHz						
	17835... 21375	MHz						
Wi-Fi 6 20MHz				$\alpha_{WLAN}^{1)}$	30	46	—	dB
	5725... 5835	MHz						
Wi-Fi 6 80MHz				$\alpha_{WLAN}^{2)}$	40	47	—	dB
	5170... 5825	MHz						
Wi-Fi 6 160MHz				$\alpha_{WLAN}^{3)}$	40	48	—	dB
	5170... 5825	MHz						

¹⁾ Average over each WLAN channel with band width of 20 MHz.

²⁾ Average over each WLAN channel with band width of 80 MHz.

³⁾ Average over each WLAN channel with band width of 160 MHz.

7 Maximum ratings

Operable temperature	$T_{OP} = -40\text{ °C} \dots +95\text{ °C}$	
Storage temperature	$T_{STG}^{1)} = -40\text{ °C} \dots +95\text{ °C}$	
DC voltage	$ V_{DC} ^{2)} = 0\text{ V (max.)}$	
ESD voltage		
	$V_{ESD}^{3)} = 375\text{ V (max.)}$	Human body model.
	$V_{ESD}^{4)} = 100\text{ V (max.)}$	Machine model.
Input power	P_{IN}	
@ input port: 5945 ... 7125 MHz	28 dBm	160 MHz WLAN signal 70% duty cycle for 20000 h @ 55 °C. Source and load impedance 50Ω. ⁵⁾
@ input port: other frequency ranges	10 dBm	Continuous wave for 10000 h @ 55 °C. Source and load impedance 50Ω.

¹⁾ Not valid for packaging material. Storage temperature for packaging material is -25 °C to +40 °C.

²⁾ In case of applied DC voltage blocking capacitors are mandatory.

³⁾ According to JESD22-A114F (HBM – Human Body Model), 1 negative & 1 positive pulse.

⁴⁾ According to JESD22-A115B (MM – Machine Model), 10 negative & 10 positive pulses.

⁵⁾ Expected lifetime according to accelerated power durability tests, and wear out models.

8 Transmission coefficient

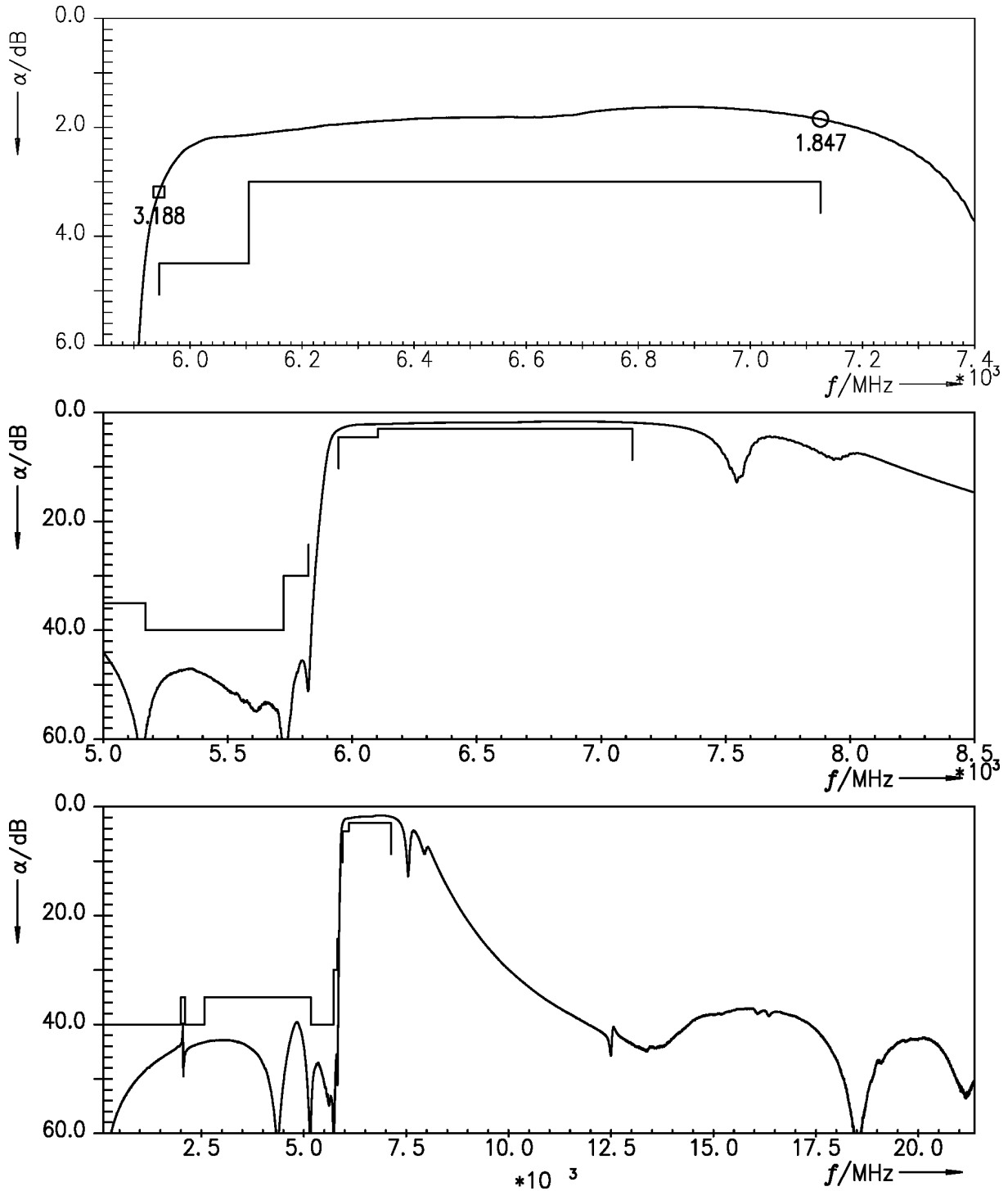

Figure 4: Attenuation.

9 Transmission coefficient (WLAN)

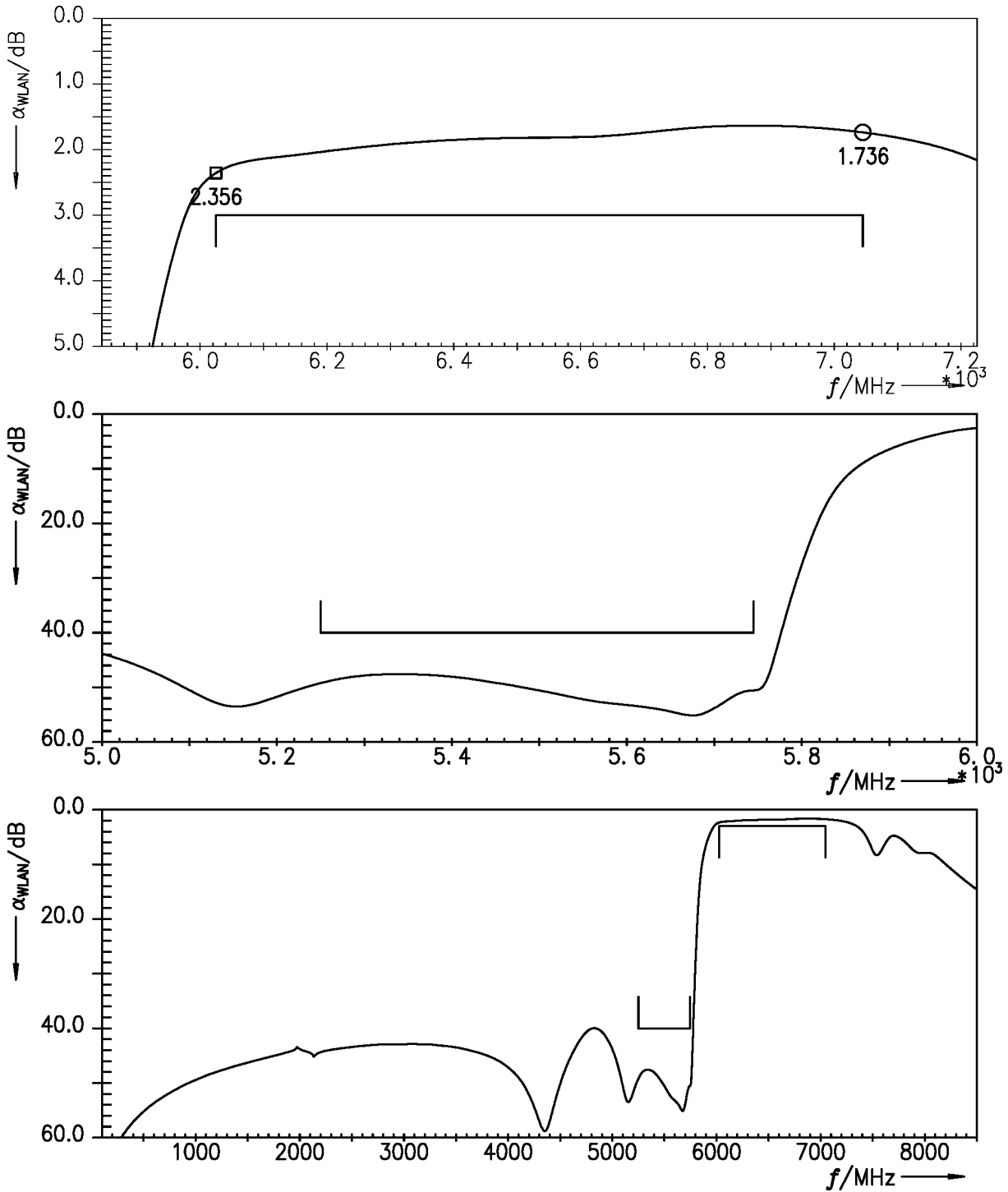

Figure 5: Attenuation (WLAN) (integration window = 160 MHz).

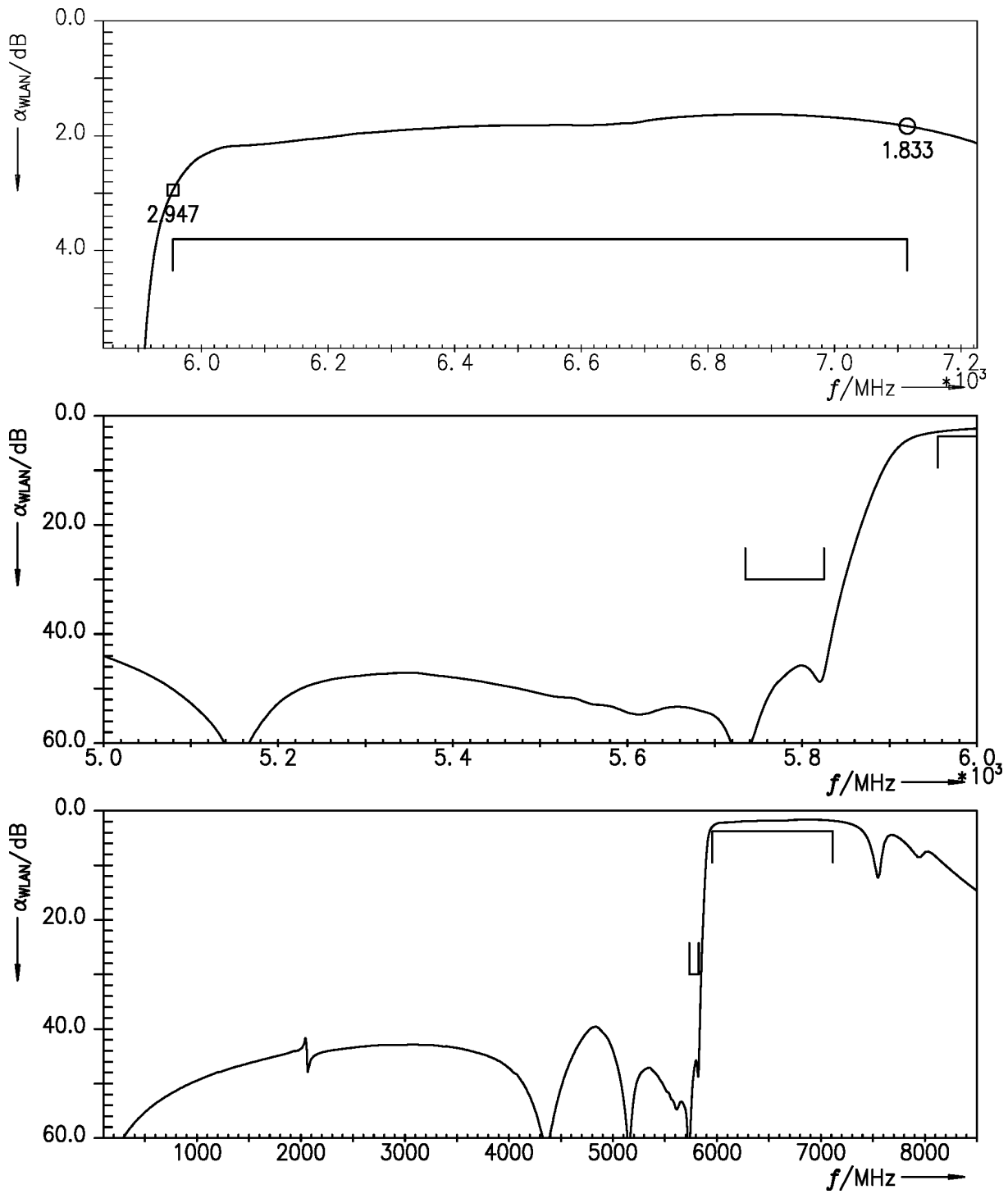

Figure 6: Attenuation (WLAN) (integration window = 20 MHz).

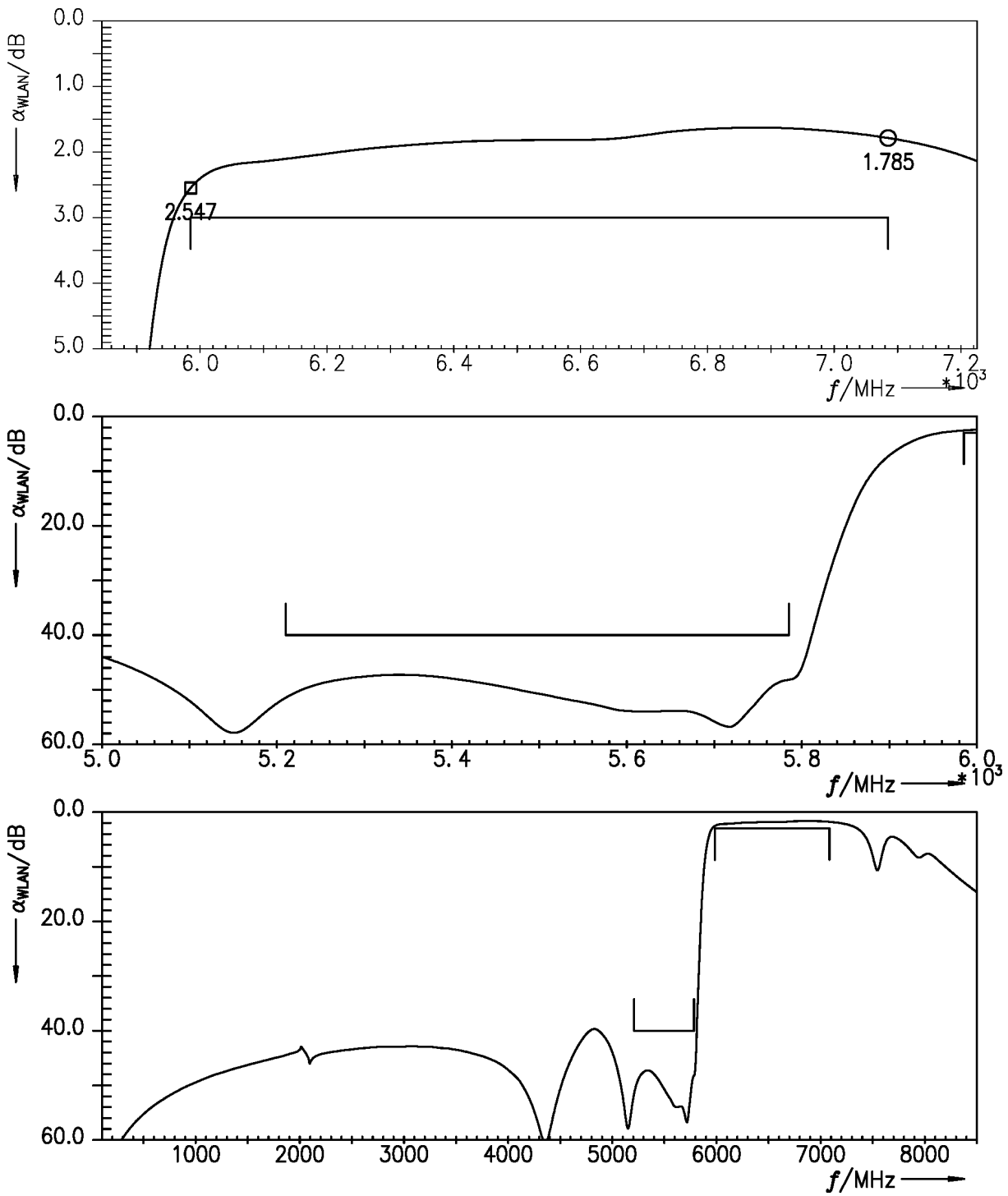

Figure 7: Attenuation (WLAN) (integration window = 80 MHz).

10 Reflection coefficients

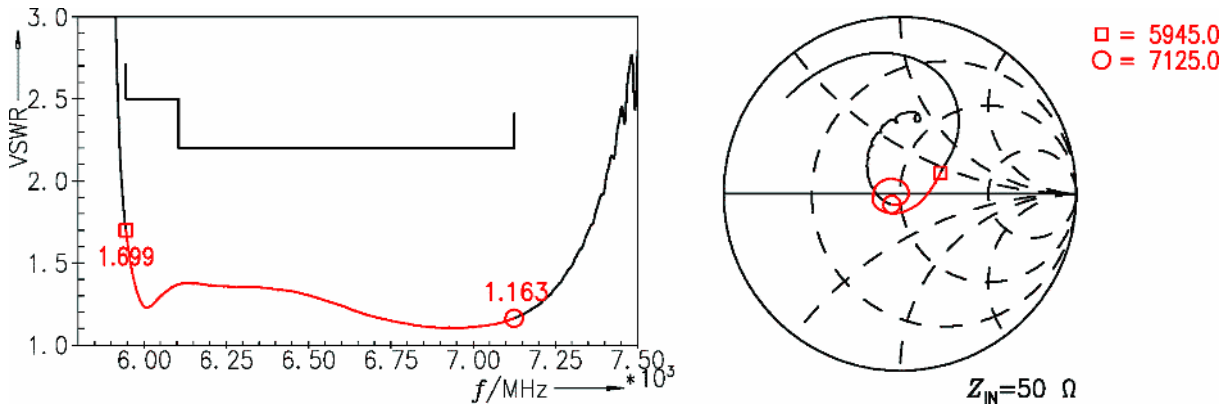

Figure 8: Reflection coefficient at input port.

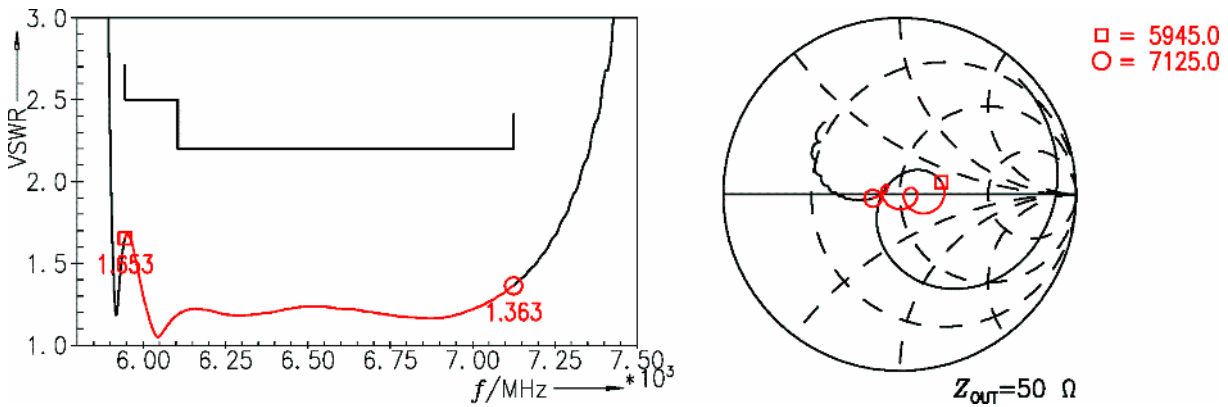

Figure 9: Reflection coefficient at output port.

11 Packing material

11.1 Tape

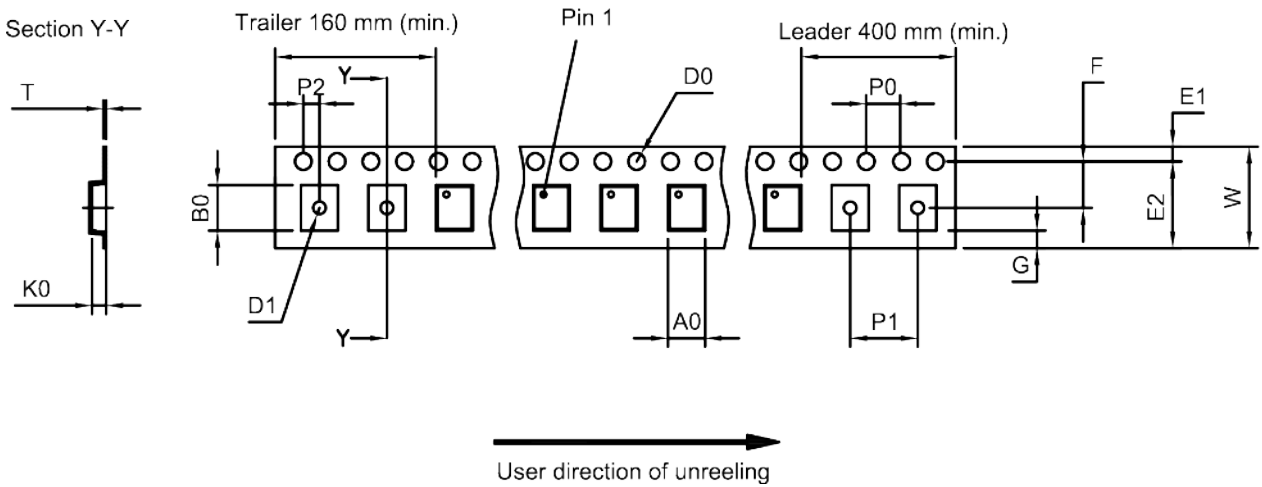

Figure 10: Drawing of tape (first-angle projection) for illustration only and not to scale. The valid tape dimensions are listed in Table 1.

A ₀	1.6±0.05 mm	E ₂	6.25 mm (min.)	P ₁	4.0±0.1 mm
B ₀	2.0±0.05 mm	F	3.5±0.05 mm	P ₂	2.0±0.05 mm
D ₀	1.5+0.1/-0 mm	G	0.75 mm (min.)	T	0.25±0.03 mm
D ₁	0.8+0.1/-0 mm	K ₀	0.73±0.05 mm	W	8.0+0.3/-0.1 mm
E ₁	1.75±0.1 mm	P ₀	4.0±0.1 mm		

Table 1: Tape dimensions.

11.2 Reel with diameter of 180 mm

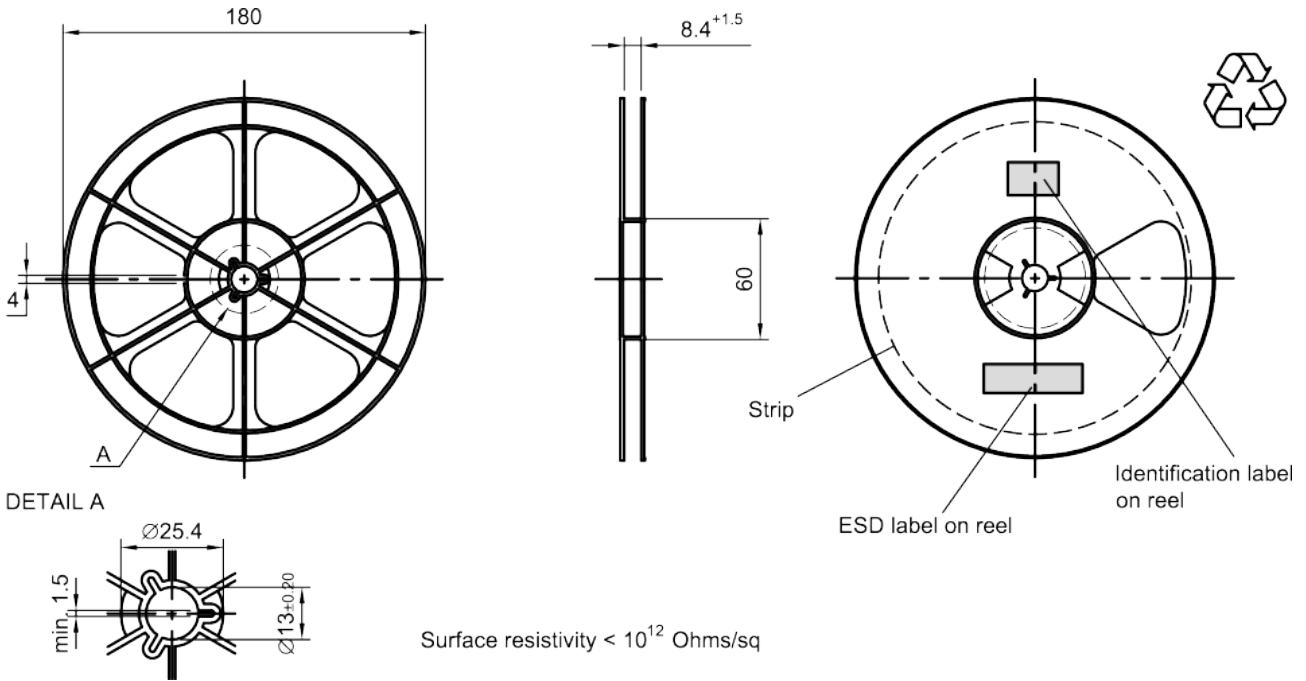

Figure 11: Drawing of reel (first-angle projection) with diameter of 180 mm.

Dimensions [mm]

X = 220+5

Y = 235+5

Sealing area 10±3

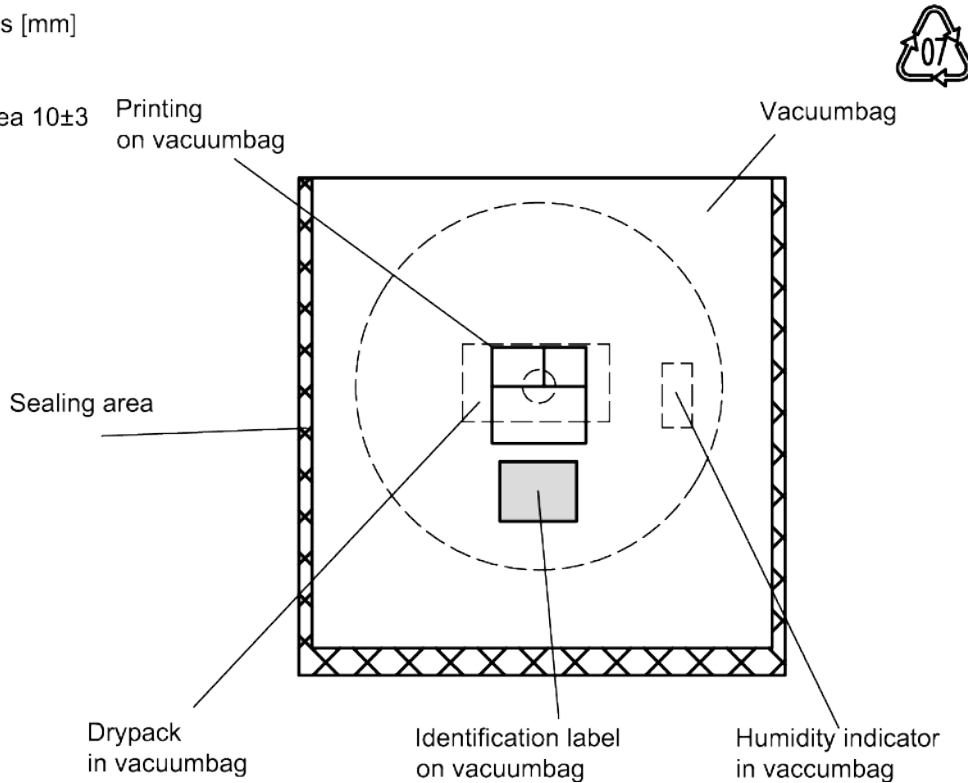

Figure 12: Drawing of moisture barrier bag (MBB) for reel with diameter of 180 mm.

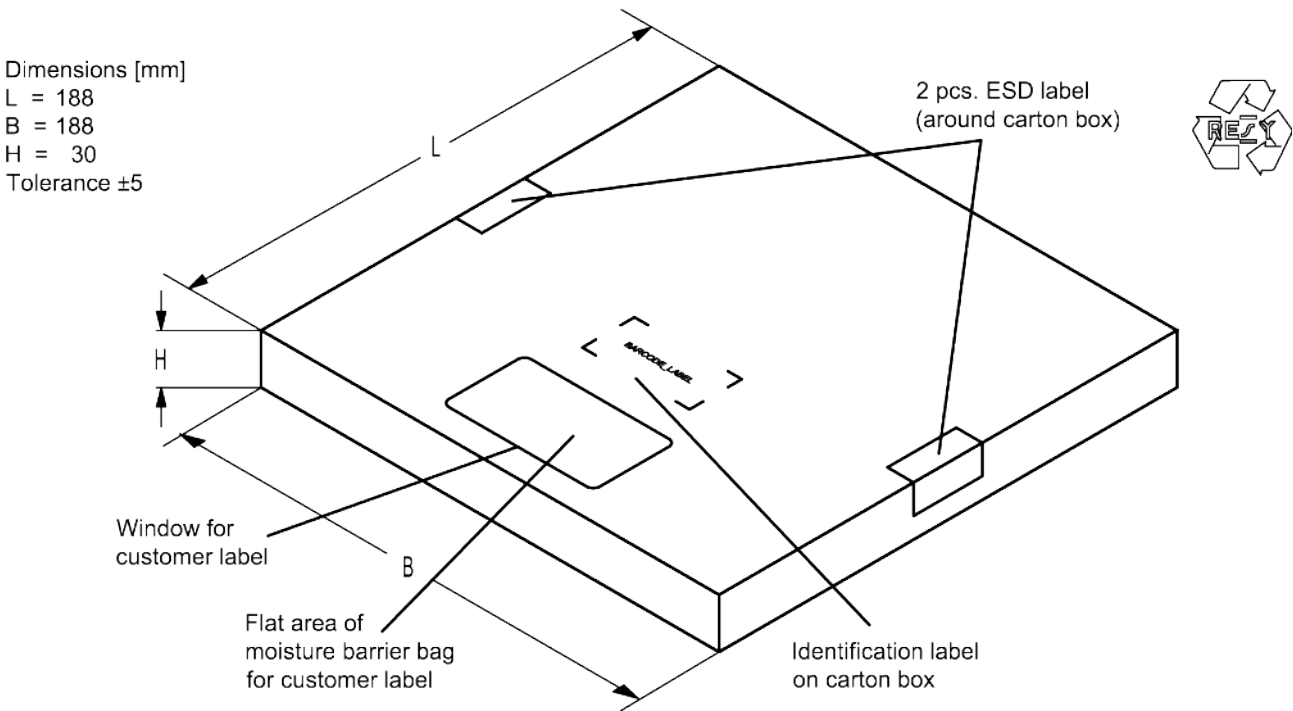

Figure 13: Drawing of folding box for reel with diameter of 180 mm.

11.3 Reel with diameter of 330 mm

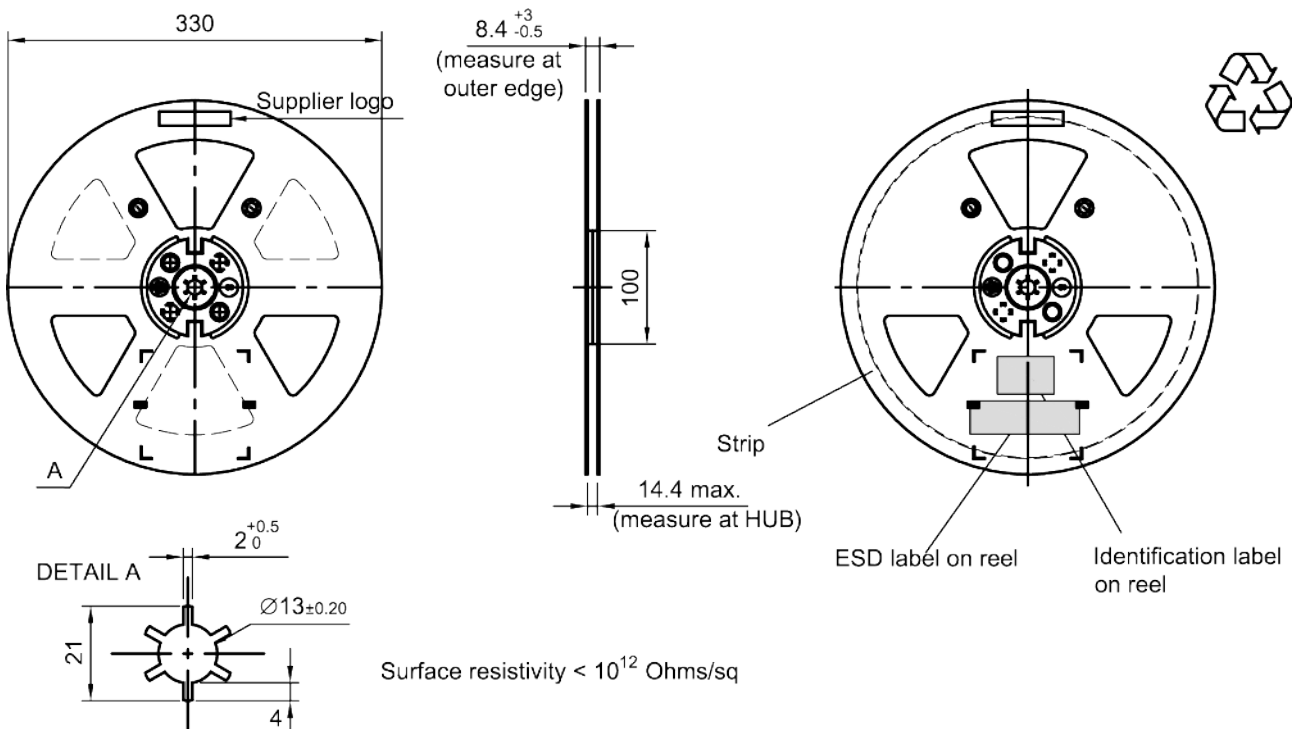

Figure 14: Drawing of reel (first-angle projection) with diameter of 330 mm.

Dimensions [mm]

X = 400+5

Y = 418+5

Sealing area 10±3

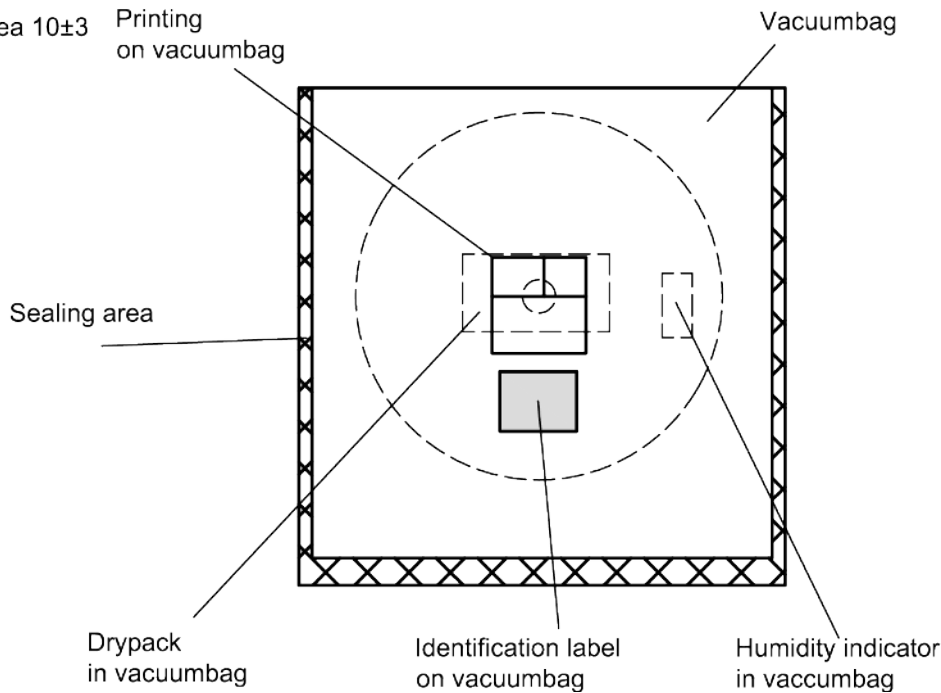

Figure 15: Drawing of moisture barrier bag (MBB) for reel with diameter of 330 mm.

Dimensions [mm]

L = 335

B = 338

H = 36 (for 8 mm tape width)

40 (for 12 mm tape width)

Tolerance ±5

2 pcs. ESD label
(around carton box)

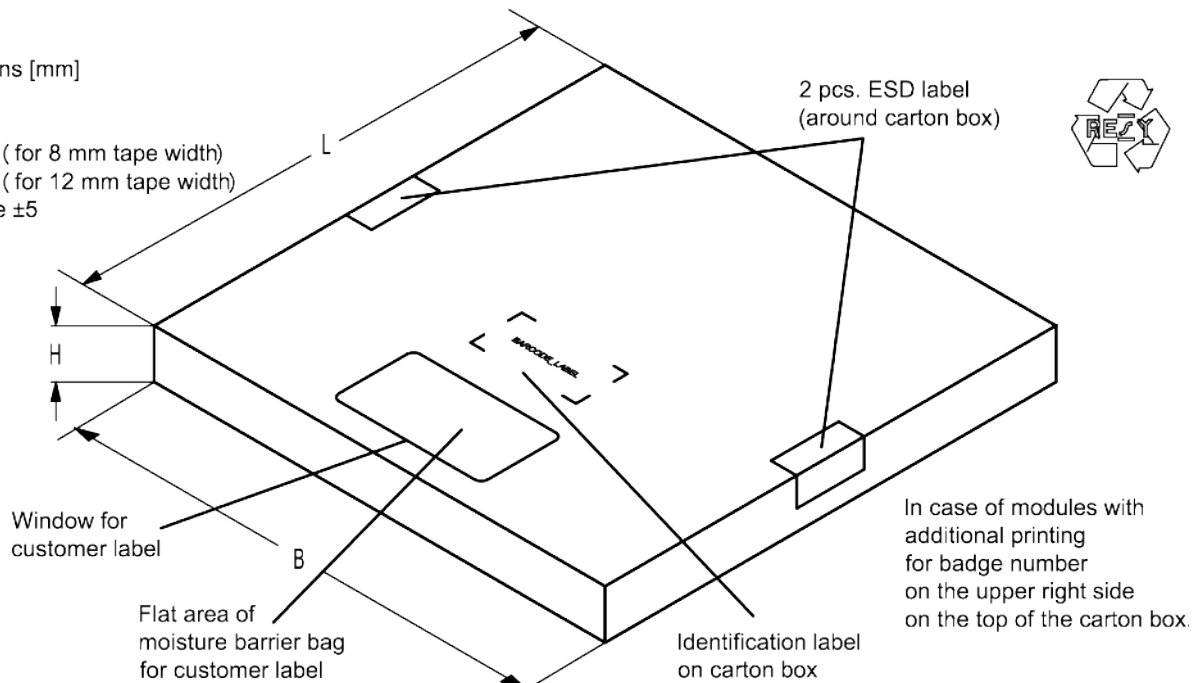

Figure 16: Drawing of folding box for reel with diameter of 330 mm.

12 Marking

Products are marked with product type number and lot number encoded according to Table 2:

■ Type number:

The 4 digit type number of the ordering code, e.g., B3xxxxB**1234**xxxx,
is encoded by a special BASE32 code into a 3 digit marking.

Example of decoding type number marking on device in decimal code.
16J => **1234**
 $1 \times 32^2 + 6 \times 32^1 + 18 (=J) \times 32^0 =$ **1234**
 The BASE32 code for product type B8380 is 85W.

■ Lot number:

The last 5 digits of the lot number, e.g., **12345**,
are encoded based on a special BASE47 code into a 3 digit marking.

Example of decoding lot number marking on device in decimal code.
5UY => **12345**
 $5 \times 47^2 + 27 (=U) \times 47^1 + 31 (=Y) \times 47^0 =$ **12345**

Adopted BASE32 code for type number			
Decimal value	Base32 code	Decimal value	Base32 code
0	0	16	G
1	1	17	H
2	2	18	J
3	3	19	K
4	4	20	M
5	5	21	N
6	6	22	P
7	7	23	Q
8	8	24	R
9	9	25	S
10	A	26	T
11	B	27	V
12	C	28	W
13	D	29	X
14	E	30	Y
15	F	31	Z

Adopted BASE47 code for lot number			
Decimal value	Base47 code	Decimal value	Base47 code
0	0	24	R
1	1	25	S
2	2	26	T
3	3	27	U
4	4	28	V
5	5	29	W
6	6	30	X
7	7	31	Y
8	8	32	Z
9	9	33	b
10	A	34	d
11	B	35	f
12	C	36	h
13	D	37	n
14	E	38	r
15	F	39	t
16	G	40	v
17	H	41	\
18	J	42	?
19	K	43	{
20	L	44	}
21	M	45	<
22	N	46	>
23	P		

Table 2: Lists for encoding and decoding of marking.

13 Soldering profile

The recommended soldering process is in accordance with IEC 60068-2-58 – 3rd edit and IPC/JEDEC J-STD-020B.

ramp rate	≤ 3 K/s
preheat	125 °C to 220 °C, 150 s to 210 s, 0.4 K/s to 1.0 K/s
$T > 220\text{ °C}$	30 s to 70 s
$T > 230\text{ °C}$	min. 10 s
$T > 245\text{ °C}$	max. 20 s
$T \geq 255\text{ °C}$	–
peak temperature T_{peak}	250 °C +0/-5 °C
wetting temperature T_{min}	230 °C +5/-0 °C for 10 s ± 1 s
cooling rate	≤ 3 K/s
soldering temperature T	measured at solder pads

Table 3: Characteristics of recommended soldering profile for lead-free solder (Sn95.5Ag3.8Cu0.7).

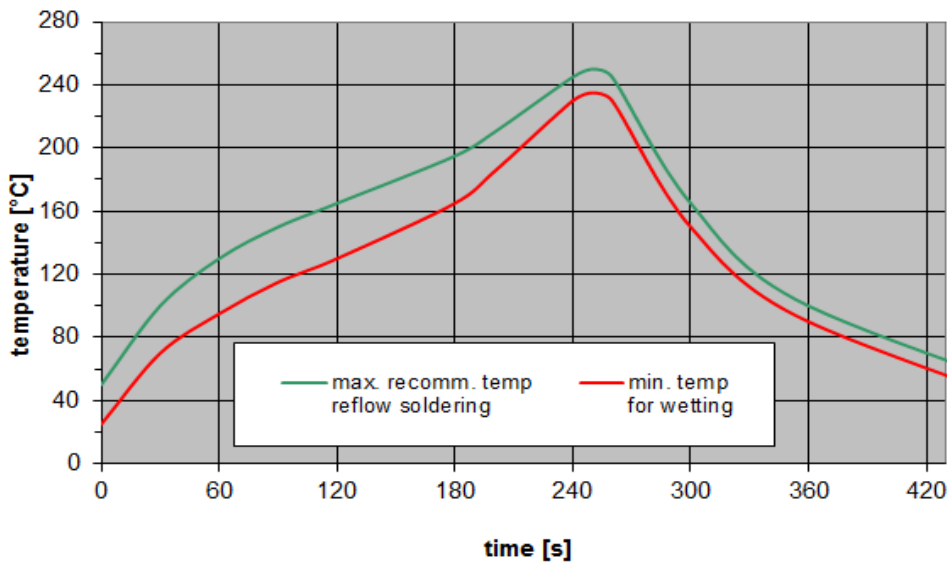

Figure 17: Recommended reflow profile for convection and infrared soldering – lead-free solder.

14 Annotations

14.1 RoHS compatibility

ROHS-compatible means that products are compatible with the requirements according to Art. 4 (substance restrictions) of Directive 2011/65/EU of the European Parliament and of the Council of June 8th, 2011, on the restriction of the use of certain hazardous substances in electrical and electronic equipment ("Directive") with due regard to the application of exemptions as per Annex III of the Directive in certain cases.

14.2 Scattering parameters (S-parameters)

The pin/port assignment is available in the headers of the S-parameter files. Please contact your local RF360 sales office.

14.3 Ordering codes, product IDs, labels, and packing units

Ordering code	Product ID	RF360 label	Packing unit
B39652B8380L210	B39652-B8380-L210-W05	B39652B8380L210W05	5000 pcs

Table 4: Ordering codes / product IDs and packing units.

15 Cautions and warnings

15.1 Display of ordering codes for RF360 products

The ordering code for one and the same product can be represented differently in data sheets, data books, other publications and the website of RF360, or in order-related documents such as shipping notes, order confirmations and product labels. The varying representations of the ordering codes are due to different processes employed and do not affect the specifications of the respective products. Detailed information can be found on the Internet under <https://rffe.qualcomm.com/>.

15.2 Material information

Due to technical requirements components may contain dangerous substances. For information on the type in question please also contact one of our sales offices.

For information on recycling of tapes and reels please contact one of our sales offices.

15.3 Moldability

Before using in overmolding environment, please contact your local RF360 sales office.

15.4 Package information

Landing area

The printed circuit board (PCB) land pattern (landing area) shown is based on RF360 internal development and empirical data and illustrated for example purposes, only. As customers' SMD assembly processes may have a plenty of variants and influence factors which are not under control or knowledge of RF360, additional careful process development on customer side is necessary and strongly recommended in order to achieve best soldering results tailored to the particular customer needs.

Dimensions

Unless otherwise specified all dimensions are understood using unit millimeter (mm).

Projection method

Unless otherwise specified first-angle projection is applied.

16 ESD protection of acoustic devices

Acoustic devices are **Electro Static Discharge** sensitive devices. To reduce the probability of damages caused by ESD, special matching topologies must be applied.

In general, “ESD matching” must be ensured at that electrical port, where electrostatic discharge is expected.

Electrostatic discharges predominantly appear at the antenna input of RF receivers. Therefore, only the input matching of the acoustic device must be designed to short circuit or to block the ESD pulse.

Below three figures show recommended “ESD matching” topologies.

For wide band acoustic devices the high-pass ESD matching structure needs to be at least of 3rd order to ensure a proper matching for any impedance value of antenna and input port. The required component values must be determined from case to case.

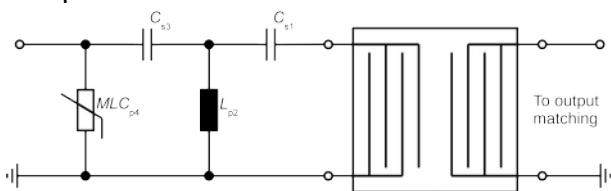

Figure 18: MLC varistor plus ESD matching.

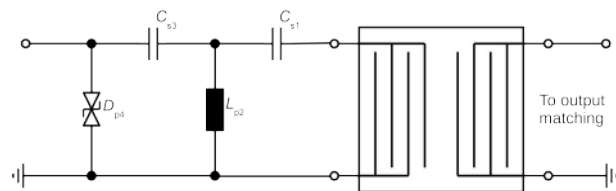

Figure 19: Suppressor diode plus ESD matching.

In cases where minor ESD occur, following simplified “ESD matching” topologies can be used alternatively.

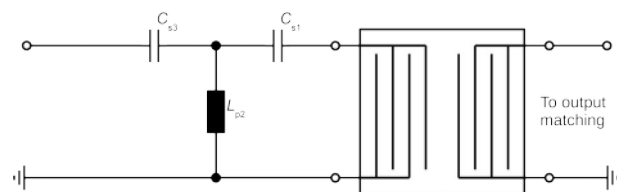

Figure 20: 3rd order high-pass structure for basic ESD protection.

In all three figures the shunt inductor L_{p2} could be replaced by a shorted microstrip with proper length and width. If this configuration is possible depends on the operating frequency and available PCB space.

Effectiveness of the applied ESD protection has to be checked according to relevant industry standards or customer specific requirements.

For further information, please refer to RF360 Application report: “**ESD protection for SAW filters**”. This report can be found under <https://rffe.qualcomm.com>.

17 Important notes

The following applies to all products named in this publication:

1. Some parts of this publication contain **statements about the suitability of our products for certain areas of application**. These statements are based on our knowledge of typical requirements that are often placed on our products in the areas of application concerned. We nevertheless expressly point out **that such statements cannot be regarded as binding statements about the suitability of our products for a particular customer application**. As a rule, RF360 Europe GmbH and its affiliates are either unfamiliar with individual customer applications or less familiar with them than the customers themselves. For these reasons, it is always ultimately incumbent on the customer to check and decide whether an RF360 product with the properties described in the product specification is suitable for use in a particular customer application.
2. We also point out that **in individual cases, a malfunction of electronic components or failure before the end of their usual service life cannot be completely ruled out in the current state of the art, even if they are operated as specified**. In customer applications requiring a very high level of operational safety and especially in customer applications in which the malfunction or failure of an electronic component could endanger human life or health (e.g. in accident prevention or life-saving systems), it must therefore be ensured by means of suitable design of the customer application or other action taken by the customer (e.g. installation of protective circuitry or redundancy) that no injury or damage is sustained by third parties in the event of malfunction or failure of an electronic component.
3. **The warnings, cautions and product-specific notes must be observed.**
4. In order to satisfy certain technical requirements, **some of the products described in this publication may contain substances subject to restrictions in certain jurisdictions (e.g. because they are classed as hazardous)**. Useful information on this will be found in our Material Data Sheets on the Internet (<https://rfe.qualcomm.com>). Should you have any more detailed questions, please contact our sales offices.
5. We constantly strive to improve our products. Consequently, **the products described in this publication may change from time to time**. The same is true of the corresponding product specifications. Please check therefore to what extent product descriptions and specifications contained in this publication are still applicable before or when you place an order. We also **reserve the right to discontinue production and delivery of products**. Consequently, we cannot guarantee that all products named in this publication will always be available.
The aforementioned does not apply in the case of individual agreements deviating from the foregoing for customer-specific products.