

PLUG MATED TO VERTICAL RECEPTACLE MATED PROFILE

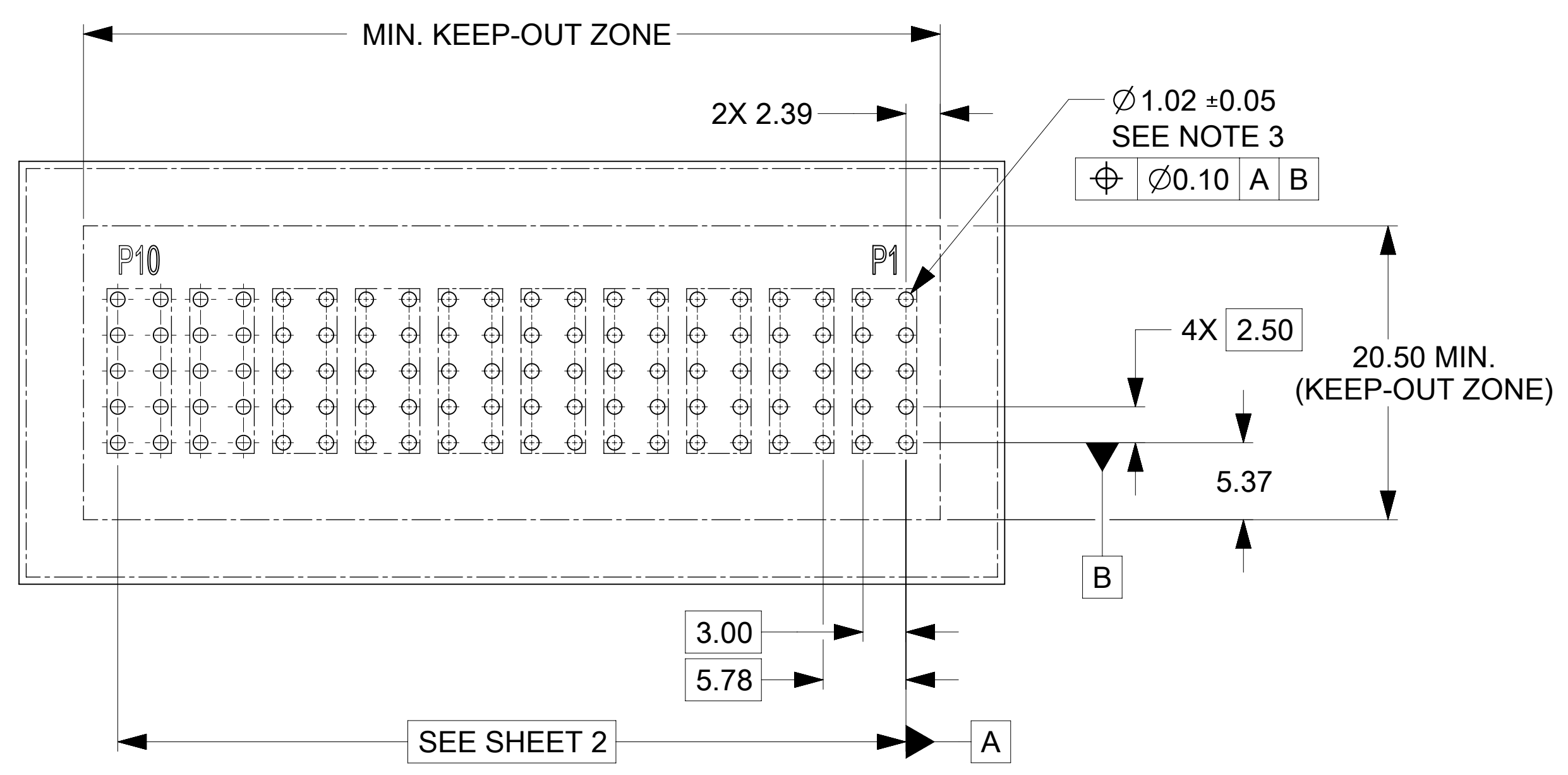

- NOTES:
- MATERIAL:
 - HOUSINGS: LCP UL94, V-0, COLOR : BLACK
 - TERMINALS: HIGH CONDUCTIVITY COPPER ALLOY
 - PLATING: 1.27 μ m (50 μ in) NICKEL OVERALL WITH
2.54 μ m (100 μ in) SELECTIVE TIN ON TAILS AND
0.762 μ m (30 μ in) SELECTIVE GOLD ON CONTACT AREA
 - PACKAGING: ASSEMBLIES TO BE TRAY PACKED PER PACKAGING SPEC: 2141140001-PK.
 - PLATED THRU HOLE SIZE, REFER TO PRODUCT SPEC. FOR DETAILS.
 - PRODUCT SPEC: 2141130000-PS.
 - PRODUCT TO MEET RoHS REQUIREMENTS.
 - VERTICAL ASSEMBLY MATES TO MOLEX PLUG 219562XXXX-SD, SEE DRAWING FOR DETAILS.
 - TAIL DESIGN: COMPLIANT PIN.
 - POWER TERMINALS ARE LUBRICATED.
 - APPLICATION SPECIFICATION: 2141130000-AS (FOR COMPLIANT TAILS ONLY).

THIS DRAWING CONTAINS INFORMATION THAT IS PROPRIETARY TO MOLEX ELECTRONIC TECHNOLOGIES, LLC AND SHOULD NOT BE USED WITHOUT WRITTEN PERMISSION									
DIMENSION UNITS	SCALE	CURRENT REV DESC:							
mm	3:1								
GENERAL TOLERANCES (UNLESS SPECIFIED)									
ANGULAR TOL	± °								
4 PLACES	±	EC NO: 745288							
3 PLACES	±	DRWN: LZABJANOVSKI 2023/03/23							
2 PLACES	± 0.25	CHK'D: JAYK1 2023/04/10							
1 PLACE	± 0.3	APPR: JAYK1 2023/04/10							
0 PLACES	±	INITIAL REVISION:							
DRAFT WHERE APPLICABLE MUST REMAIN WITHIN DIMENSIONS		THIRD ANGLE PROJECTION		DRAWING		SERIES		MATERIAL NUMBER	
		D-SIZE		219563		SEE CHART		CUSTOMER	
								SHEET NUMBER	
								1 OF 2	

RECOMMENDED PCB LAYOUT AND KEEP-OUT ZONE

PART NUMBER	CONFIGURATION	QUANTITY PER CARTON (DU)
219563-0031	1P	820

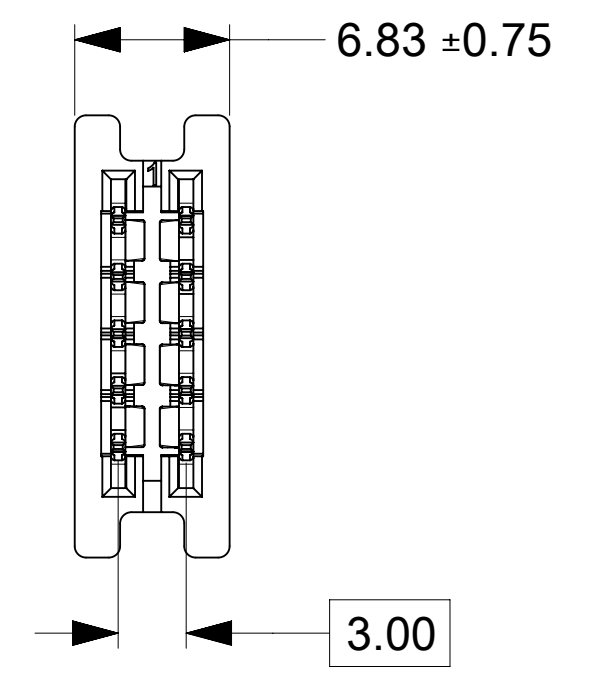

PART NUMBER	CONFIGURATION	QUANTITY PER CARTON (DU)
219563-0032	2P	440

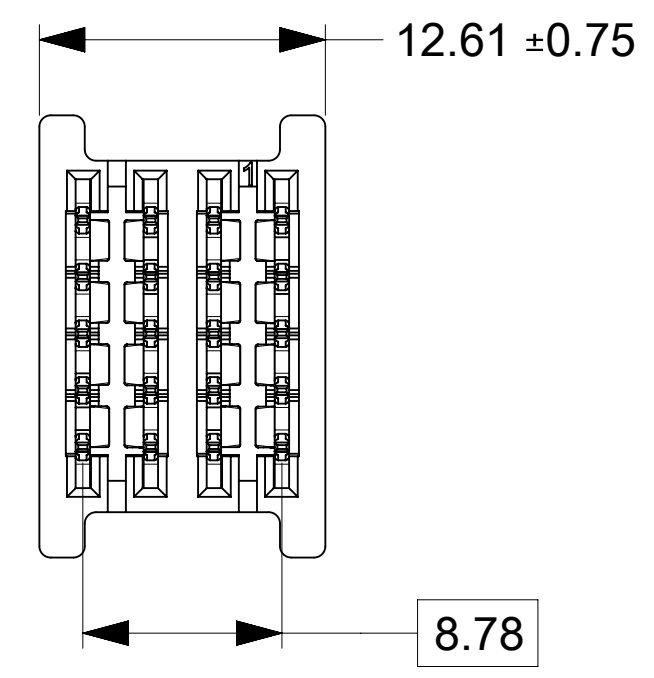

PART NUMBER	CONFIGURATION	QUANTITY PER CARTON (DU)
219563-0033	3P	300

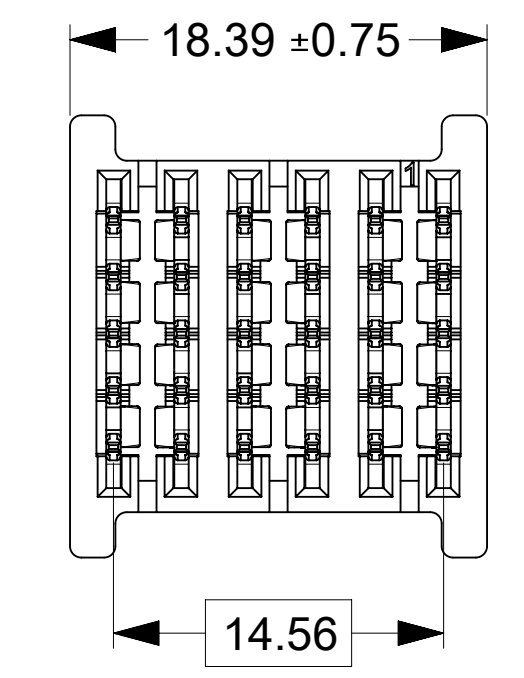

PART NUMBER	CONFIGURATION	QUANTITY PER CARTON (DU)
219563-0034	4P	220

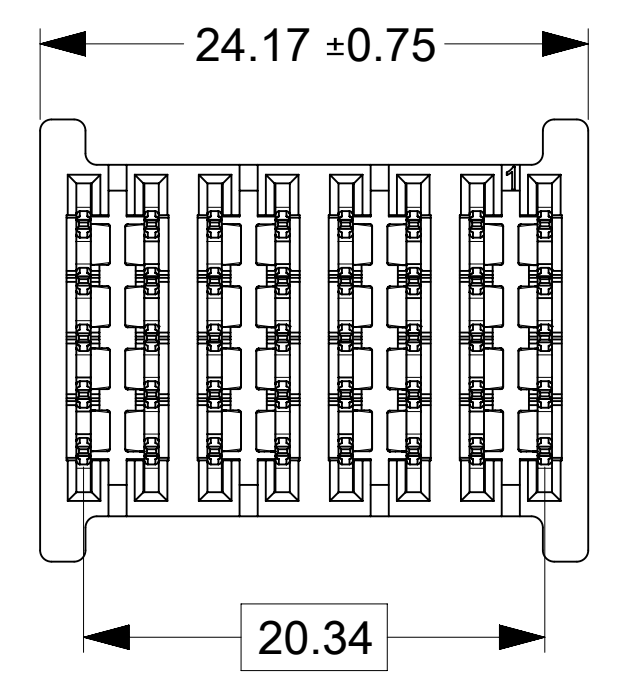

PART NUMBER	CONFIGURATION	QUANTITY PER CARTON (DU)
219563-0035	5P	180

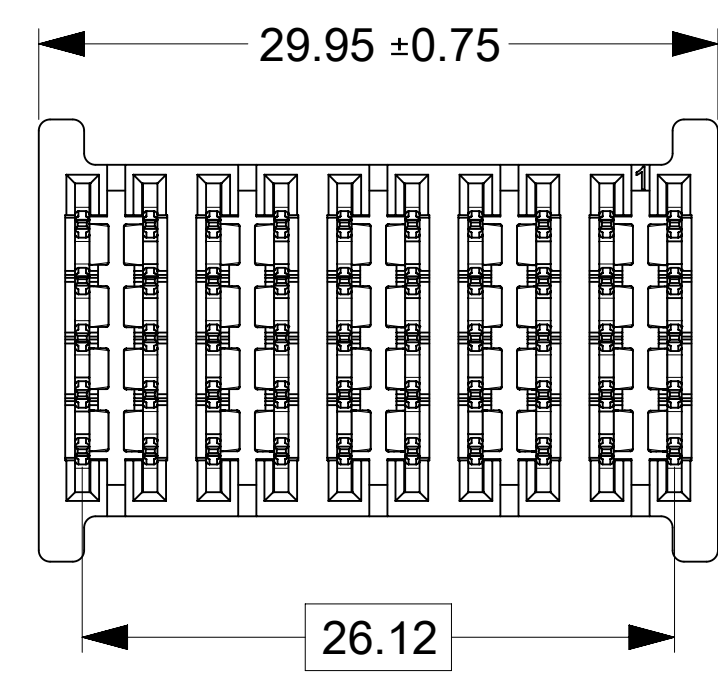

PART NUMBER	CONFIGURATION	QUANTITY PER CARTON (DU)
219563-0036	6P	140

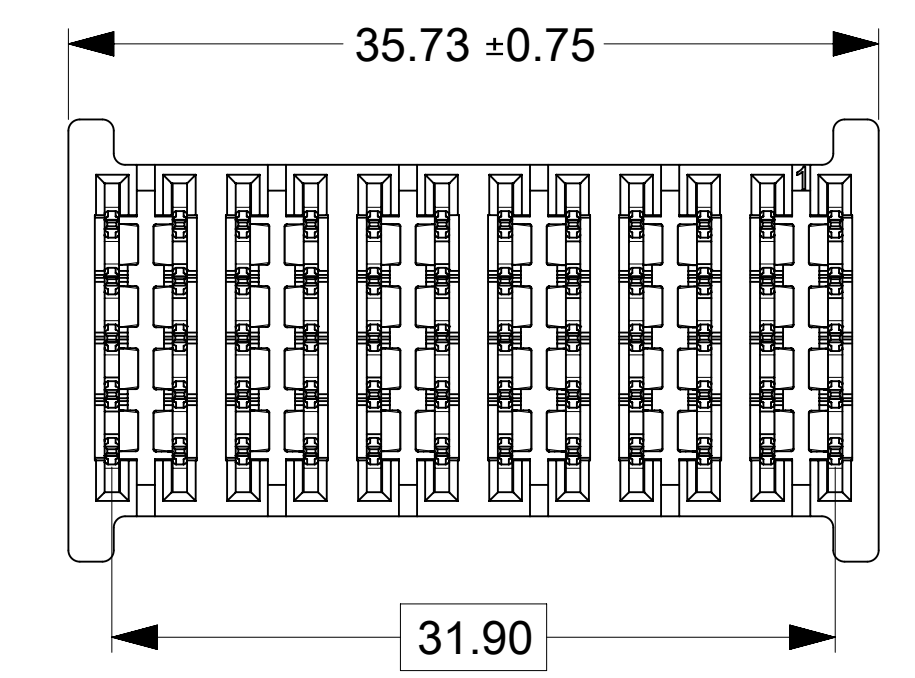

PART NUMBER	CONFIGURATION	QUANTITY PER CARTON (DU)
219563-0037	7P	120

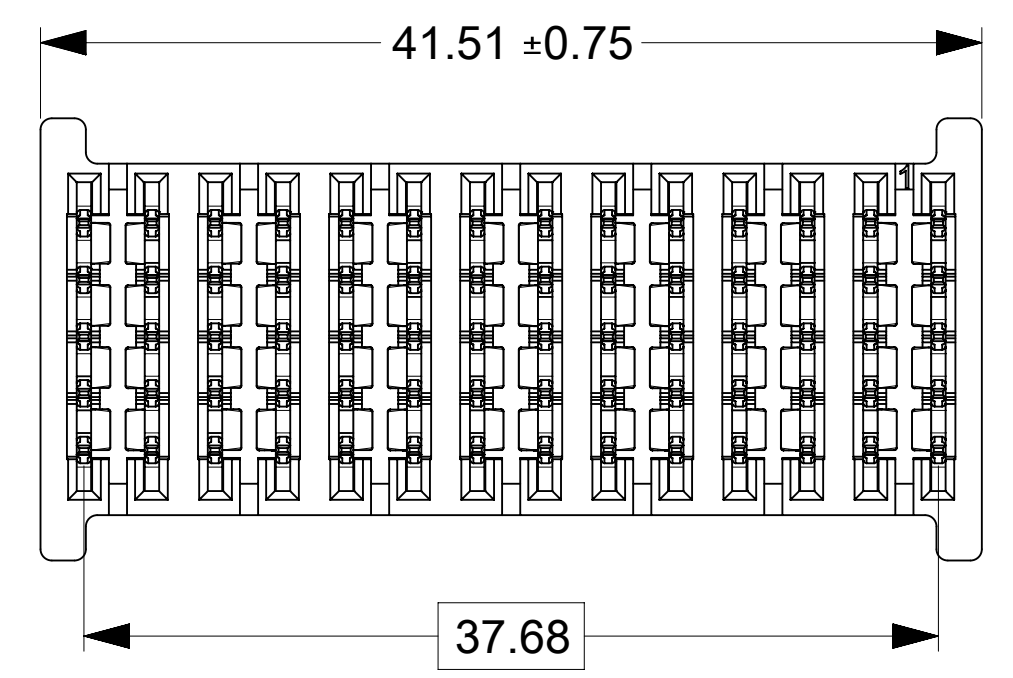

PART NUMBER	CONFIGURATION	QUANTITY PER CARTON (DU)
219563-0038	8P	100

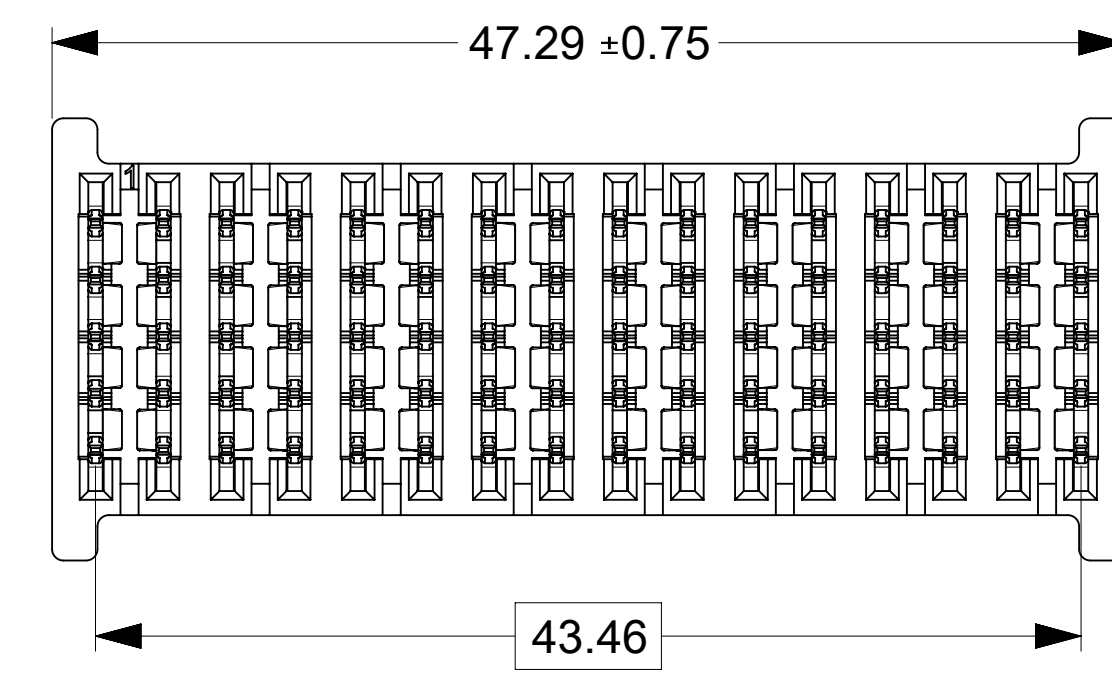

PART NUMBER	CONFIGURATION	QUANTITY PER CARTON (DU)
219563-0039	9P	100

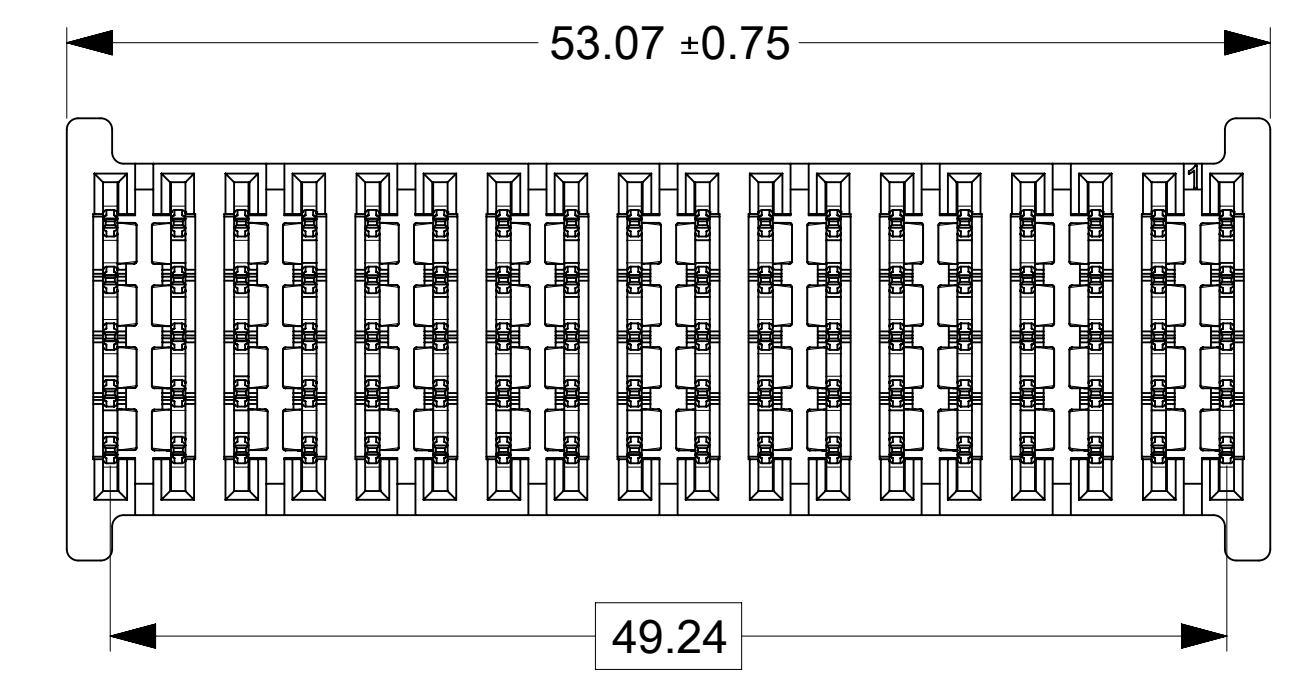

PART NUMBER	CONFIGURATION	QUANTITY PER CARTON (DU)
219563-0040	10P	80

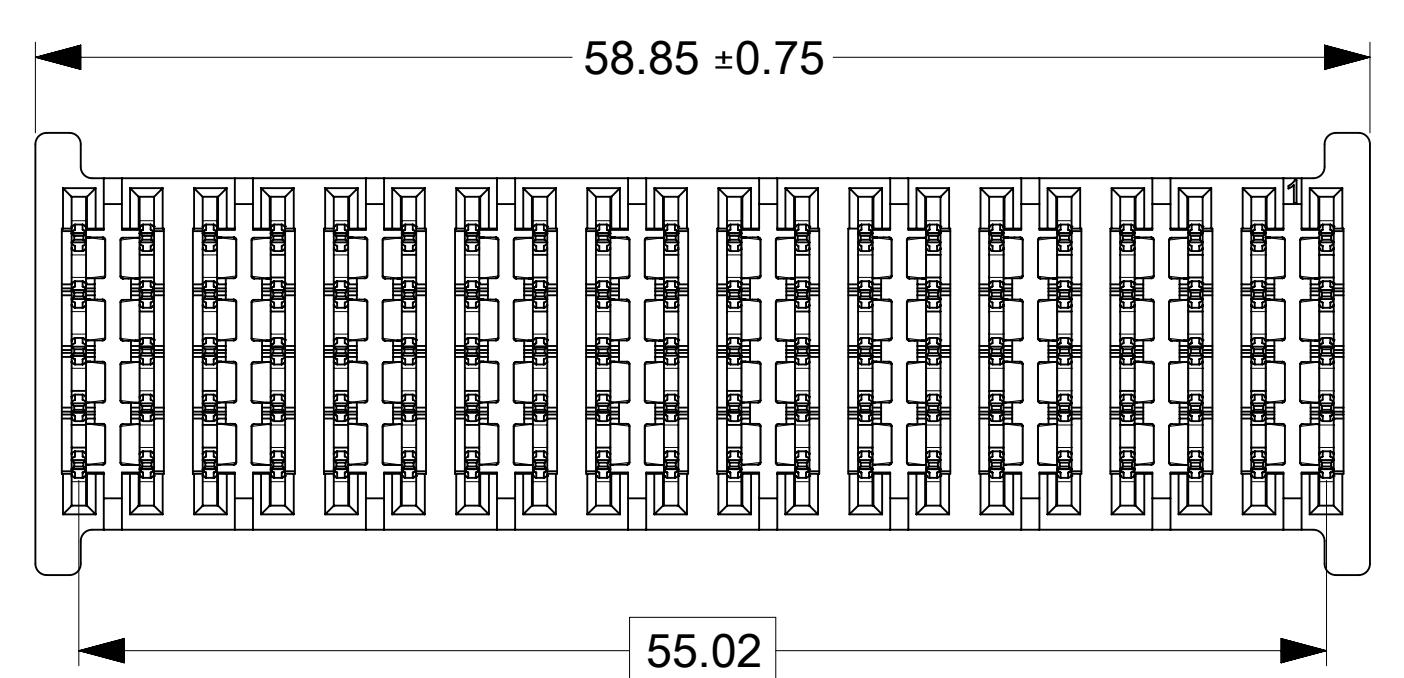

*** VIEWS SHOWN ON THIS SHEET ARE FROM THE BOTTOM OF THE CONNECTOR**

THIS DRAWING CONTAINS INFORMATION THAT IS PROPRIETARY TO MOLEX ELECTRONIC TECHNOLOGIES, LLC AND SHOULD NOT BE USED WITHOUT WRITTEN PERMISSION			
DIMENSION UNITS	SCALE	CURRENT REV DESC:	
mm	3:1		
GENERAL TOLERANCES (UNLESS SPECIFIED)			
ANGULAR TOL	± °		
4 PLACES	±		
3 PLACES	±		
2 PLACES	± 0.25		
1 PLACE	± 0.3		
0 PLACES	±		
DRAFT WHERE APPLICABLE MUST REMAIN WITHIN DIMENSIONS		THIRD ANGLE PROJECTION	DRAWING SERIES
			D-SIZE 219563
		MATERIAL NUMBER	CUSTOMER
		SEE CHART	
DOCUMENT NUMBER		DOC TYPE	DOC PART
2195639003-SD		PSD	000
REVISION		SHEET NUMBER	
A2		2 OF 2	



GUARDIAN HD VREC POWER ONLY
UNGUIDED PF

PRODUCT CUSTOMER DRAWING